

introduction はじめに

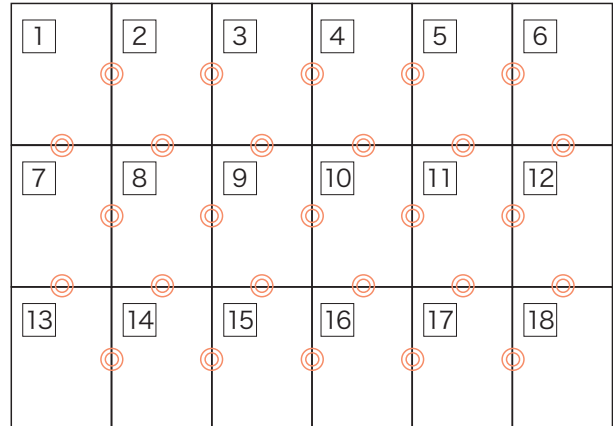

パターンは A4 サイズ 18 枚に分割されています。
印刷後、右図のようにつなぎ合わせてください。

! 印刷時の注意

印刷設定では、「ページの拡大や縮小」を選択せず
必ず、「実際のサイズ」(原寸) で印刷してください。



how to make パターンのつくりかた

- STEP1** 斜線部分  は切り取り、灰色部分  は残してのりしろにします。
(斜線と灰色を間違えないように注意)
- STEP2** 各用紙の番号を確認し、 の位置を合わせて、のりづけします。
(水のりは用紙が波打ちます。スティック糊などをお使いください)
- STEP3** それぞれのパーツをハサミで切り出します。

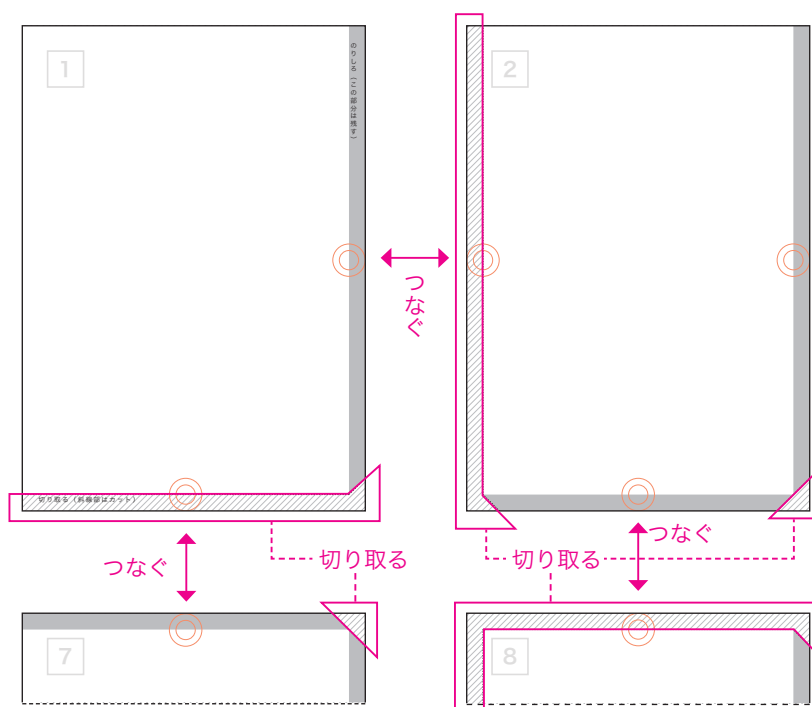

1



2

1.0

1.0

F. C

*左上前

押さえステッチ

1.0

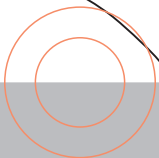
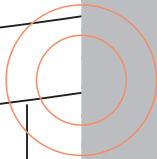
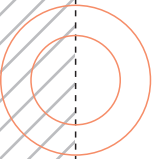

3

1.0

fabfab-10

前パンツ

size : 11

表×2枚

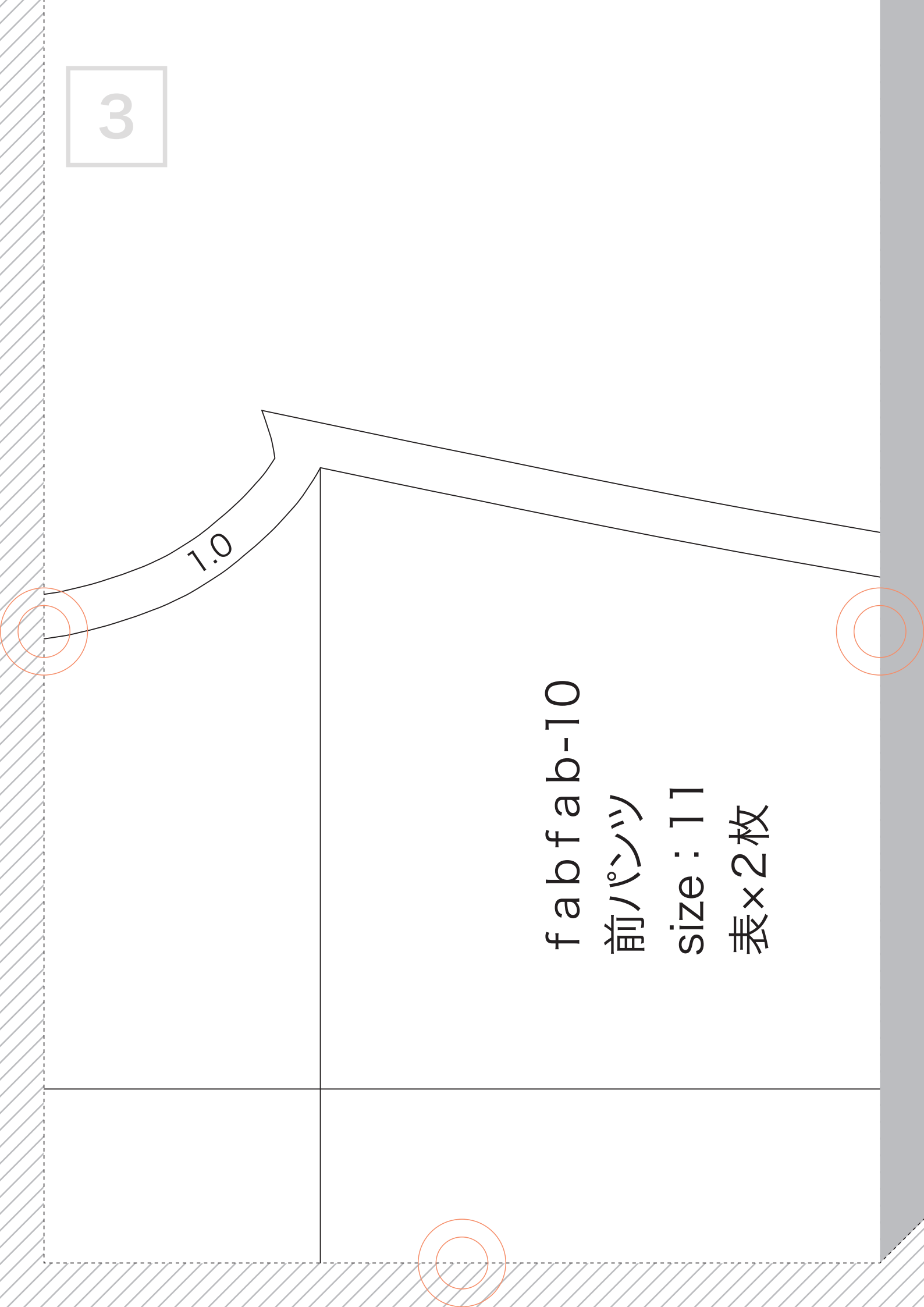

4

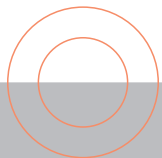
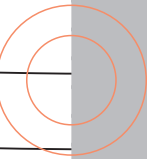
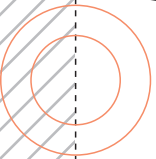
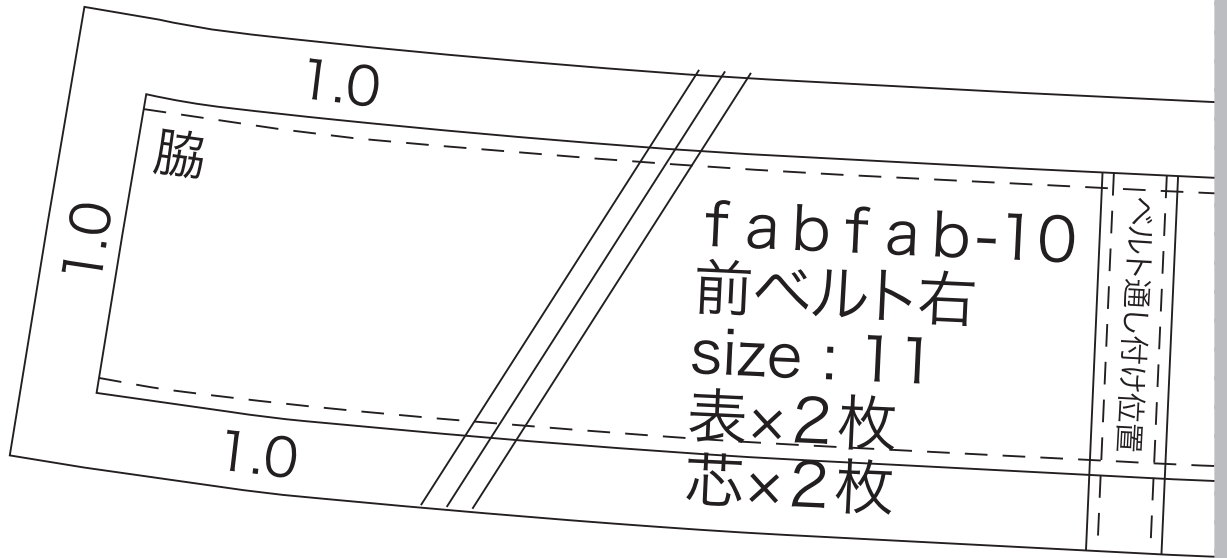

5

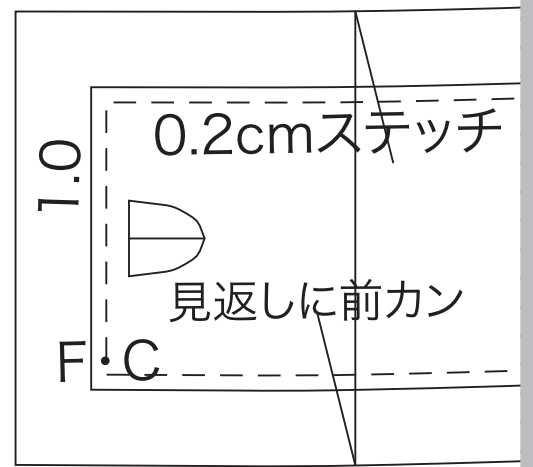
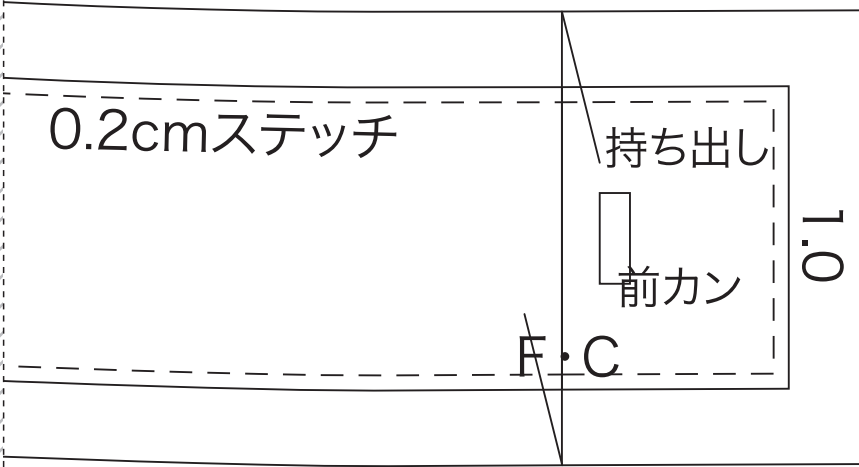

1.0

6

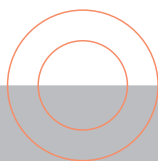
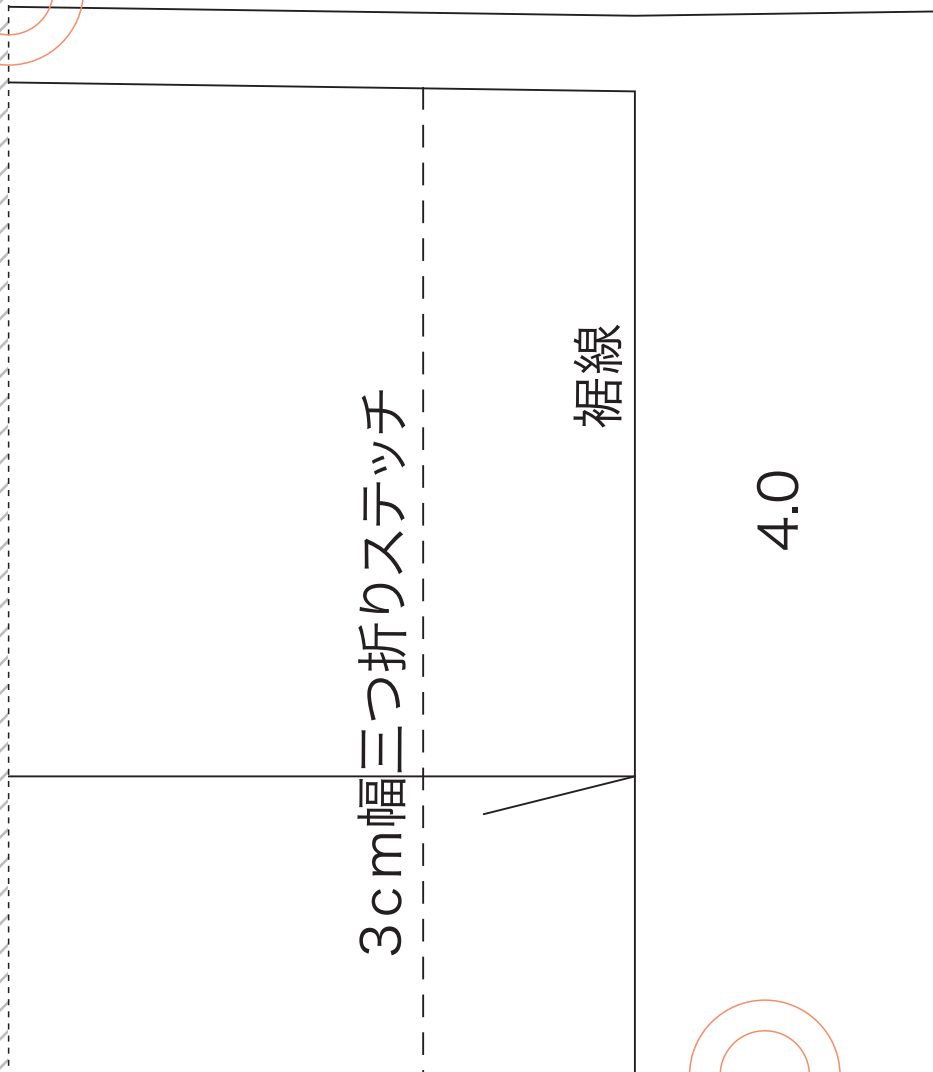
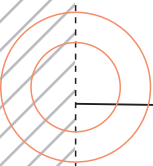
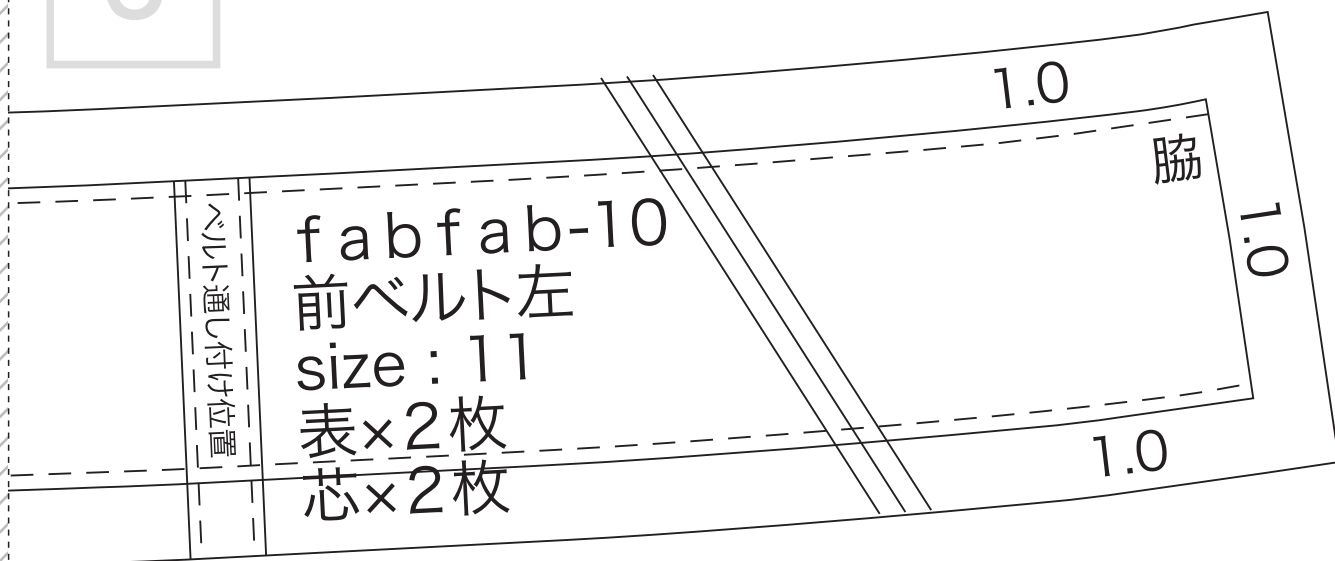

7

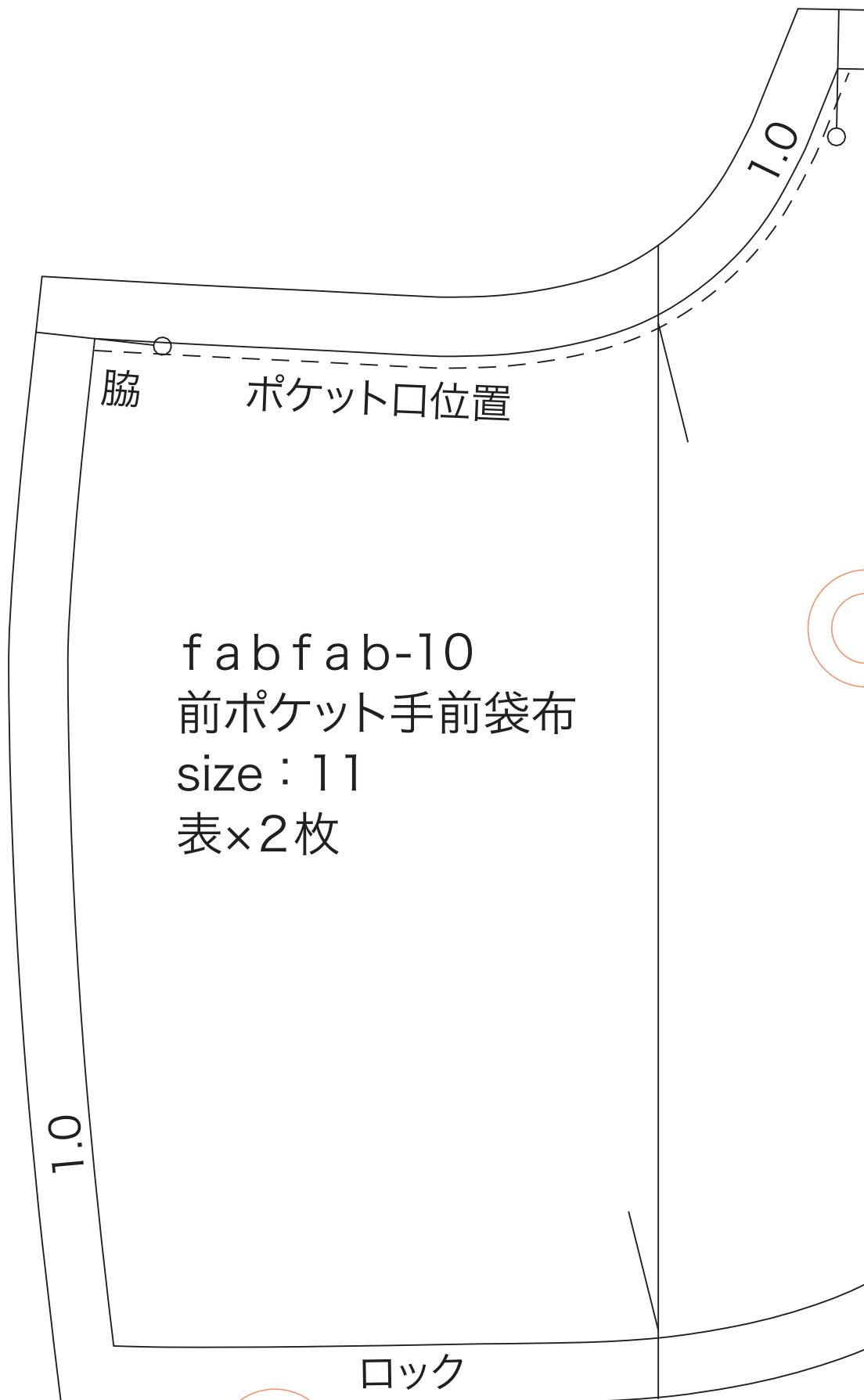

8

1.0

1.0

ポケット口位置

脇

脇

1.0

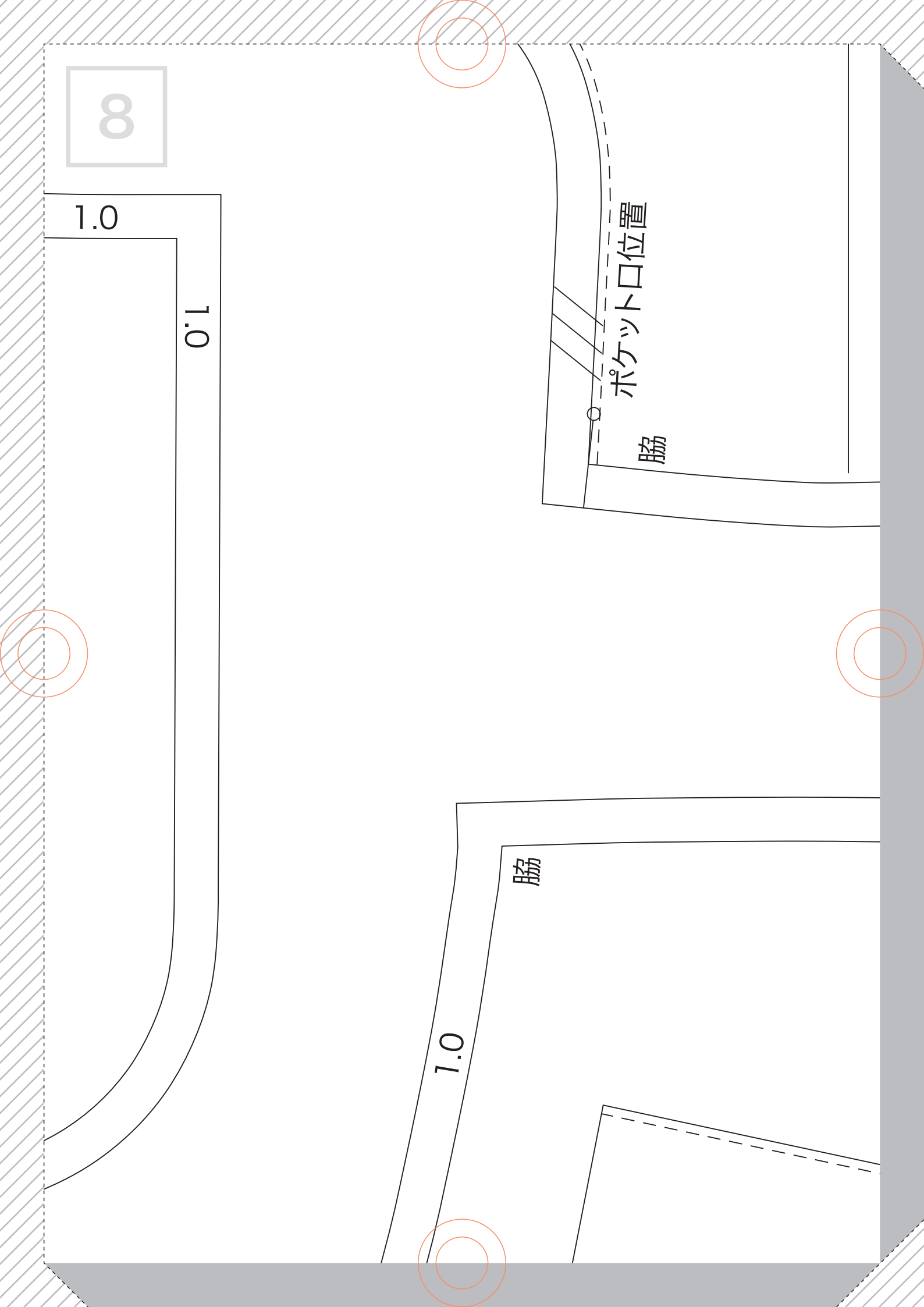

9

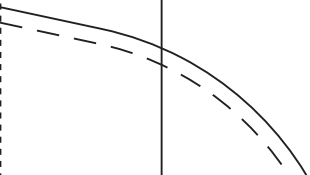
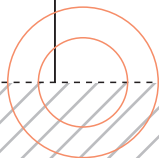
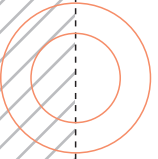
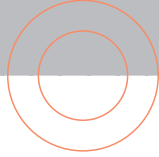

10

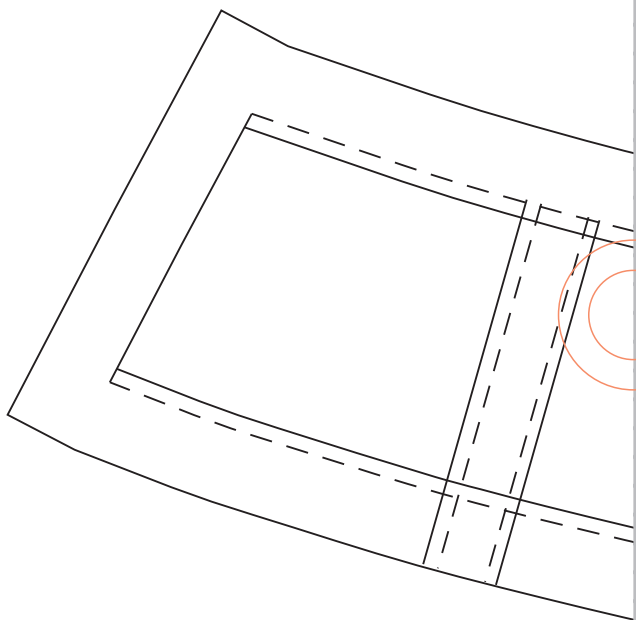
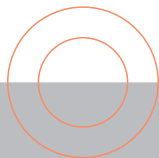
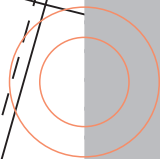
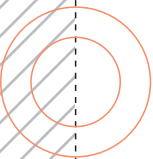
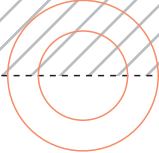

11

0.1

fabfab-10
後ベルト
size: 11
表×2枚
芯×2枚

B. C

1.0

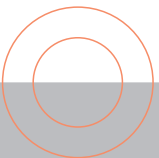
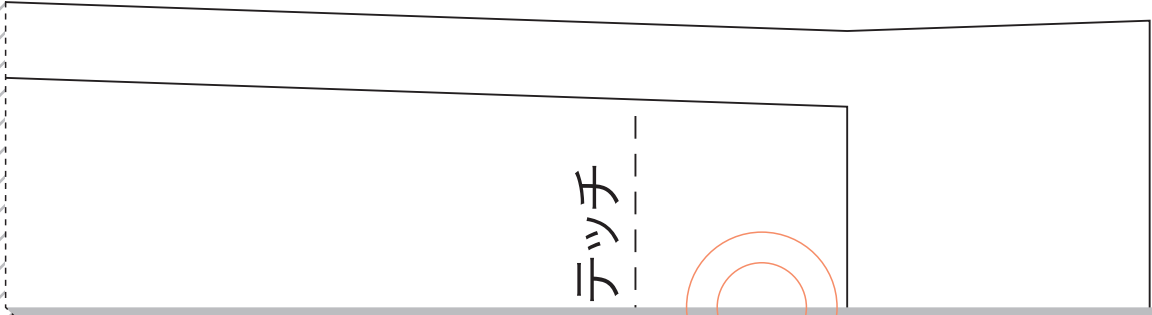
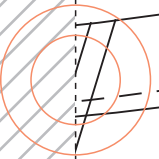
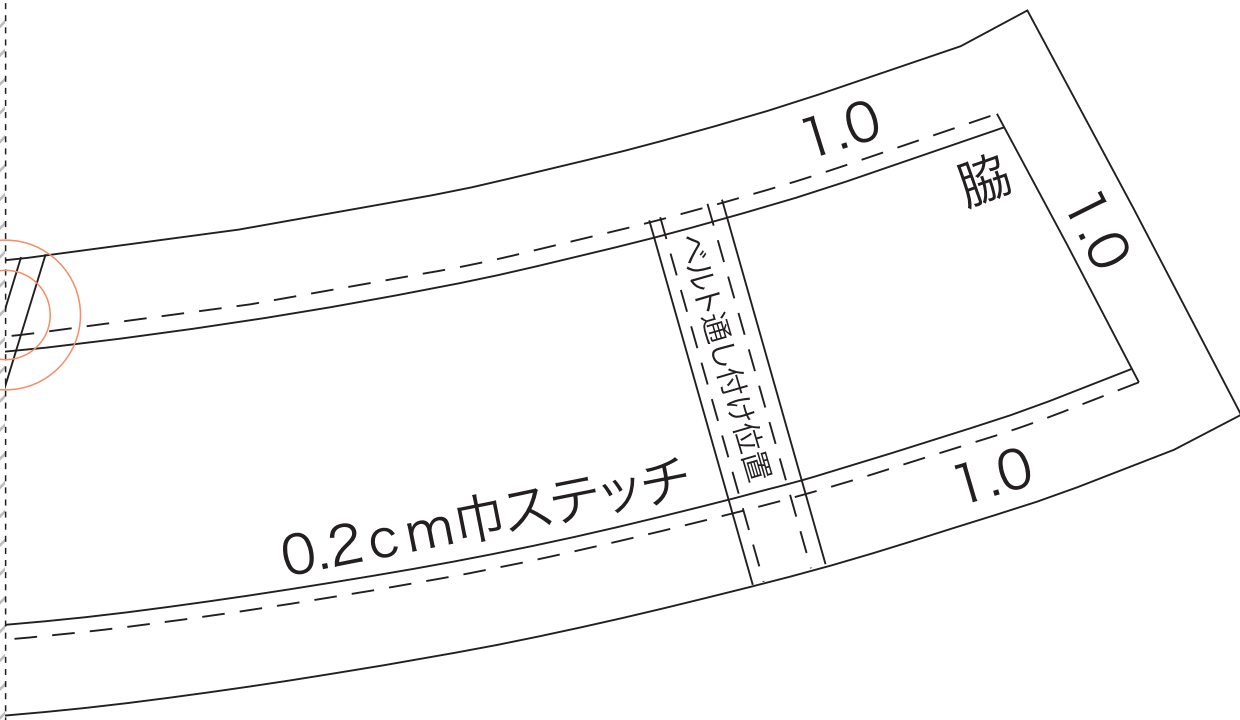
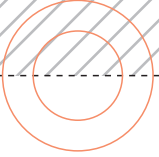
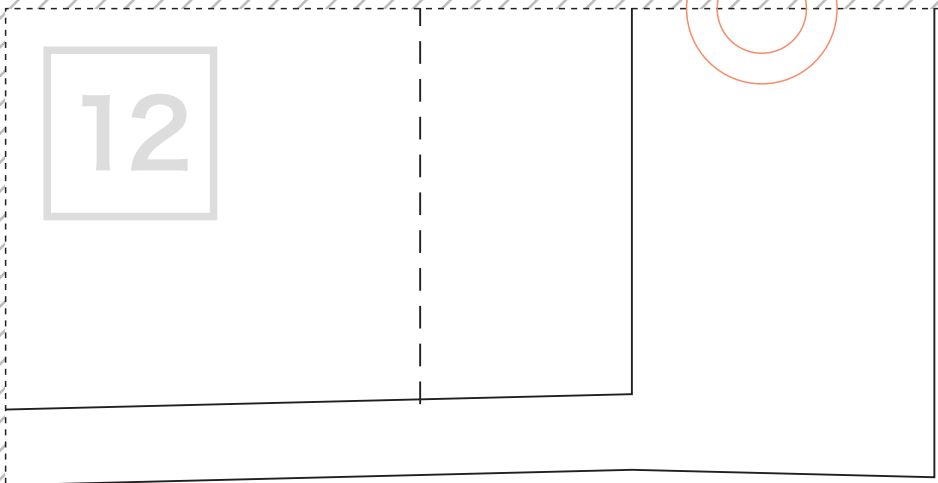

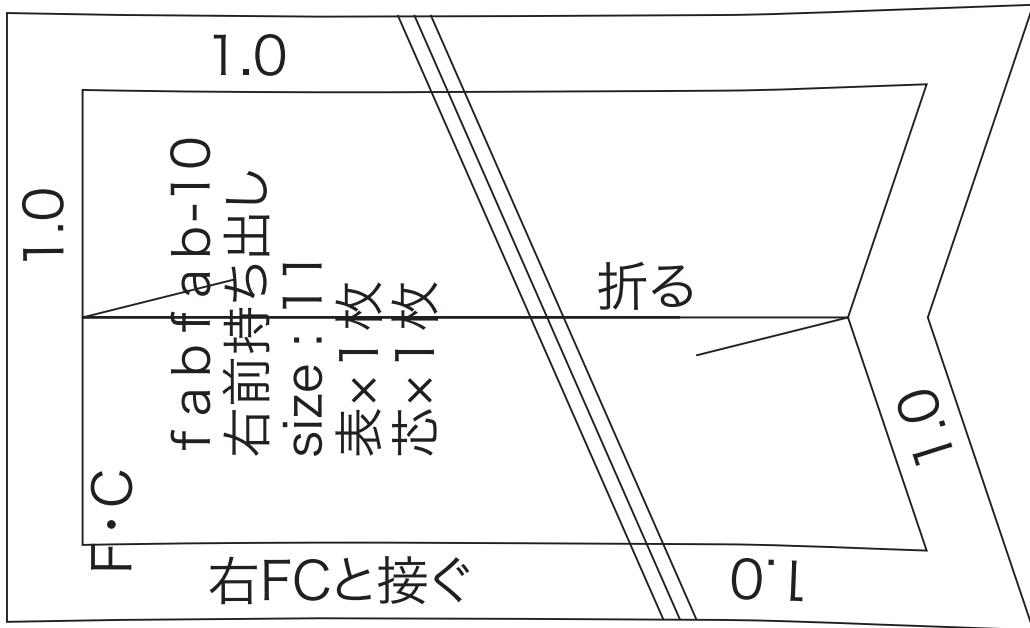
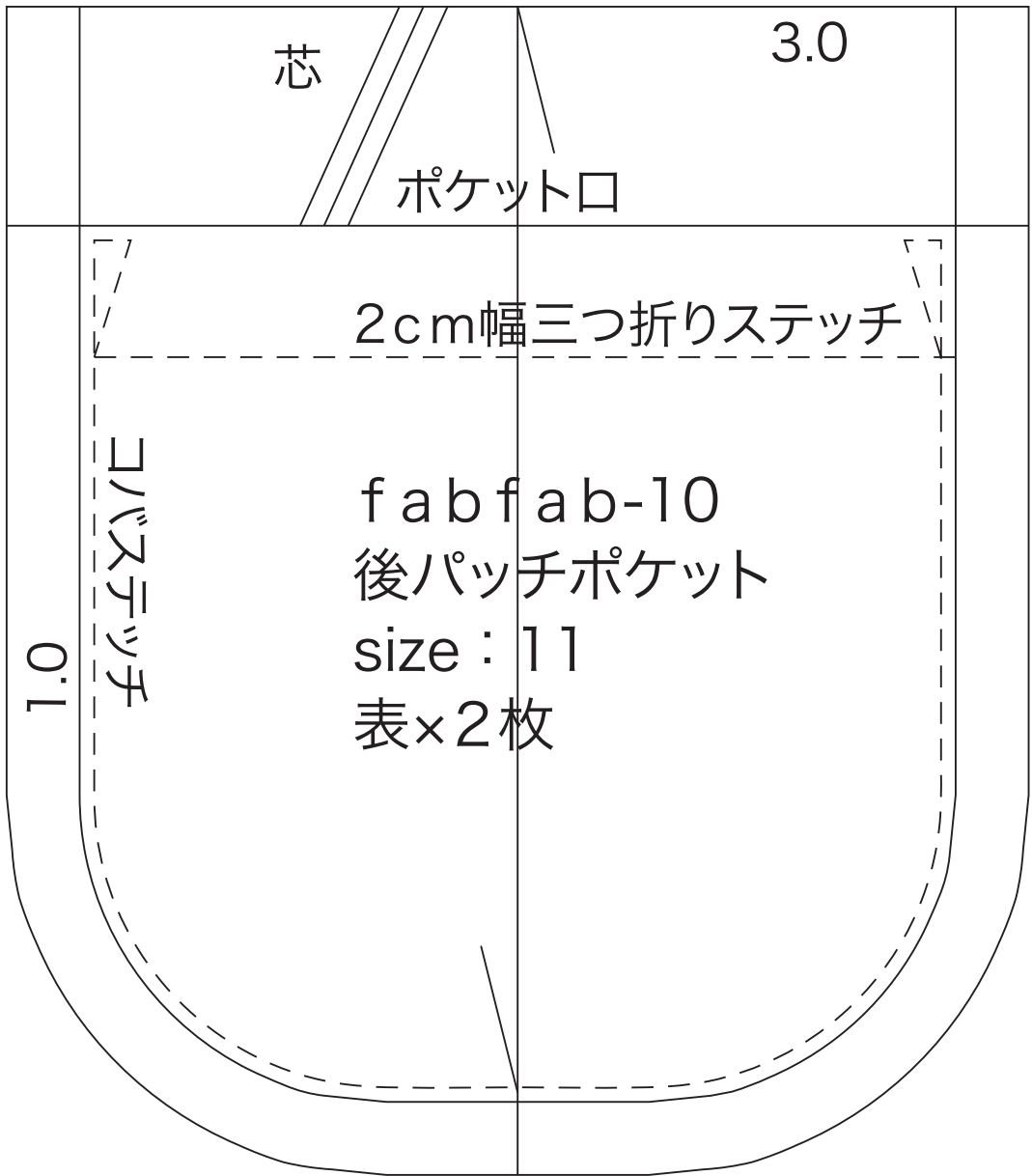

14

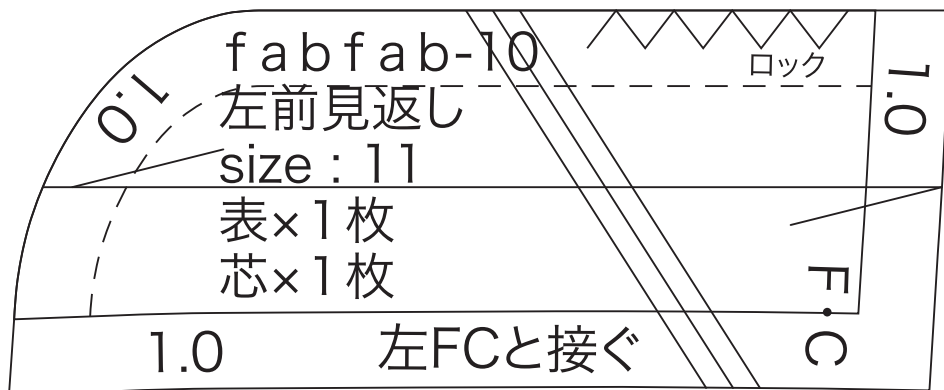
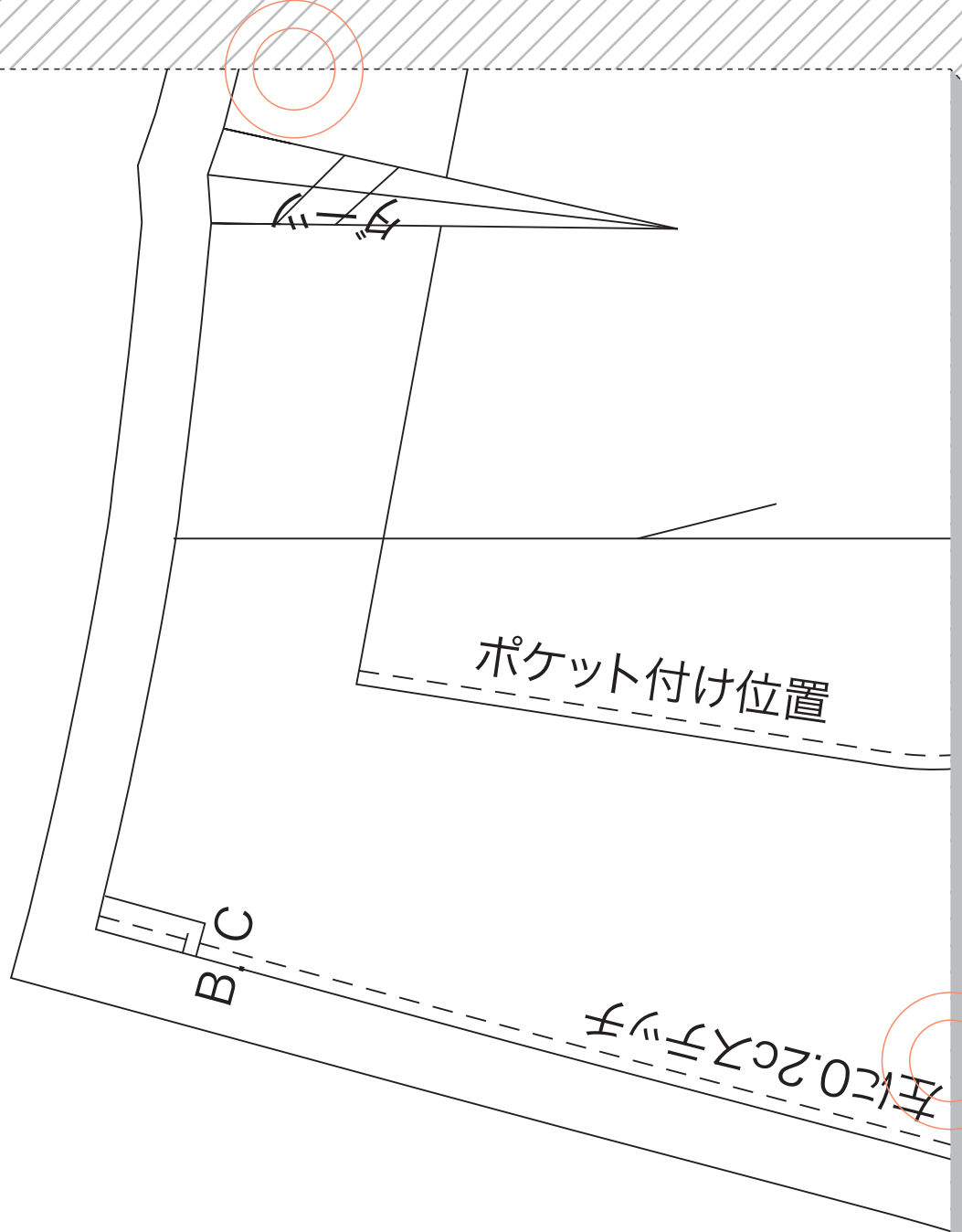

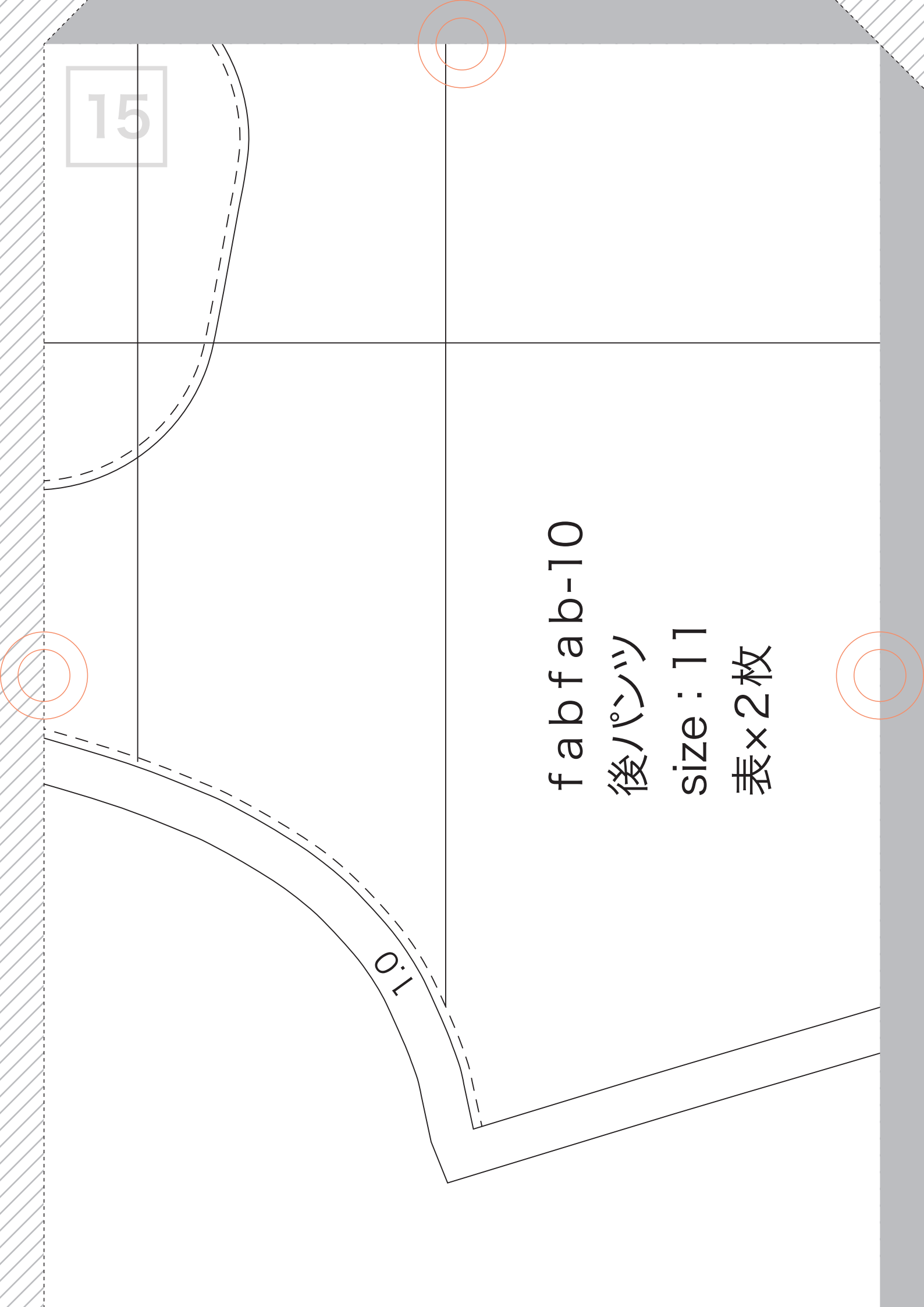

15

fabfab-10

後パンツ

size : 11

表×2枚

1:0

16

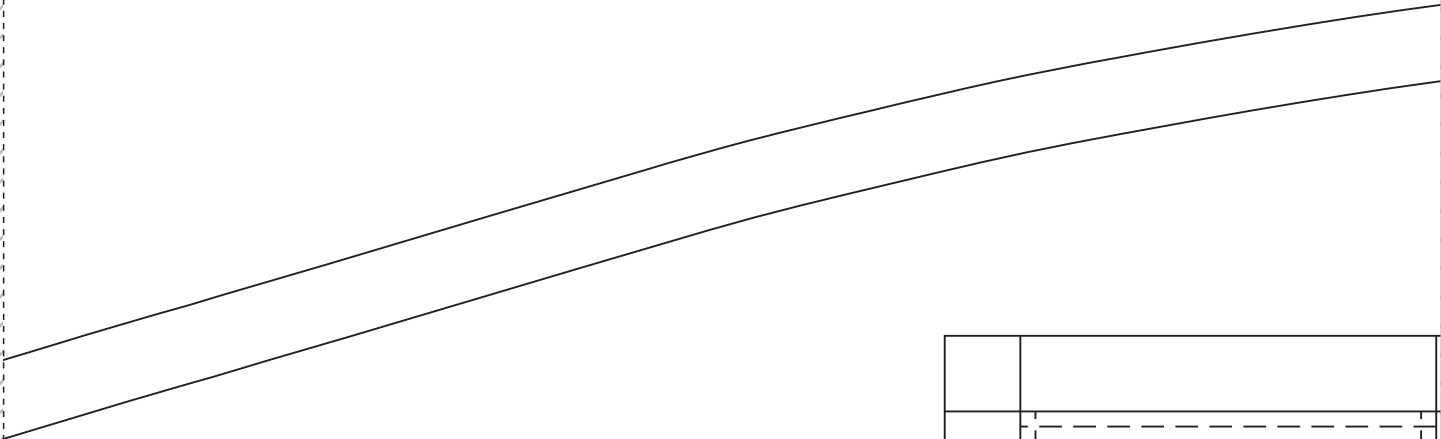
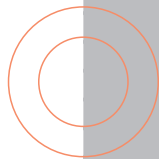
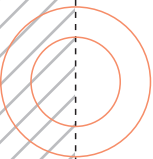
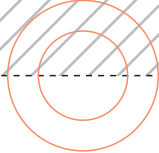

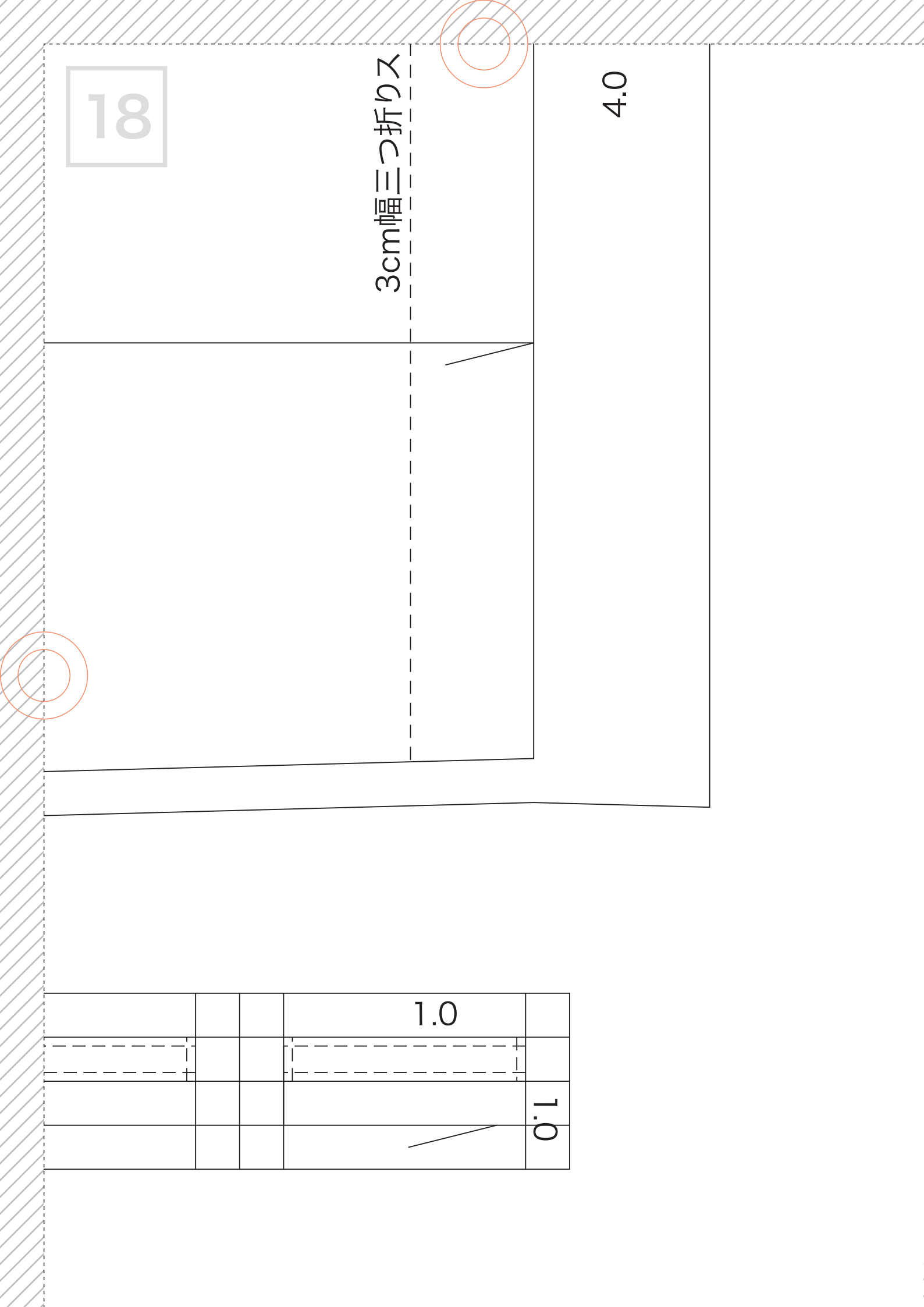

18

3cm幅三つ折りス

4.0

1.0

0.1