

## introduction はじめに

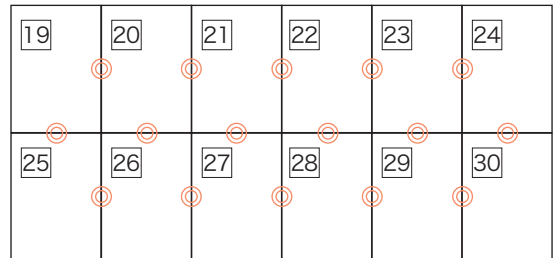
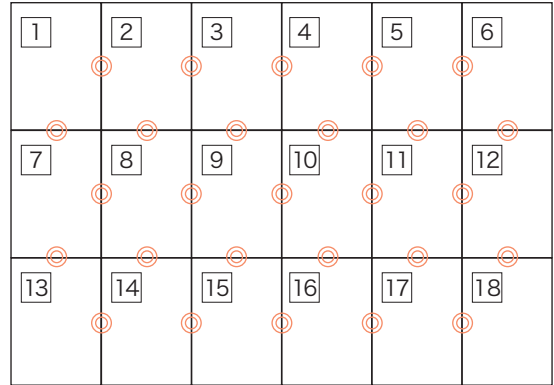

パターンは A4 サイズ 30 枚に分割されています。  
印刷後、右図のようにつなぎ合わせてください。

### ! 印刷時の注意

印刷設定では、「ページの拡大や縮小」を選択せず  
必ず、「実際のサイズ」(原寸) で印刷してください。



## how to make パターンのつくりかた

**STEP1** 斜線部分  は切り取り、灰色部分  は残してのりしろにします。  
(斜線と灰色を間違えないように注意)

**STEP2** 各用紙の番号を確認し、 の位置を合わせて、のりづけします。  
(水のりは用紙が波打ちます。スティック糊などをお使いください)

**STEP3** それぞれのパーツをハサミで切り出します。

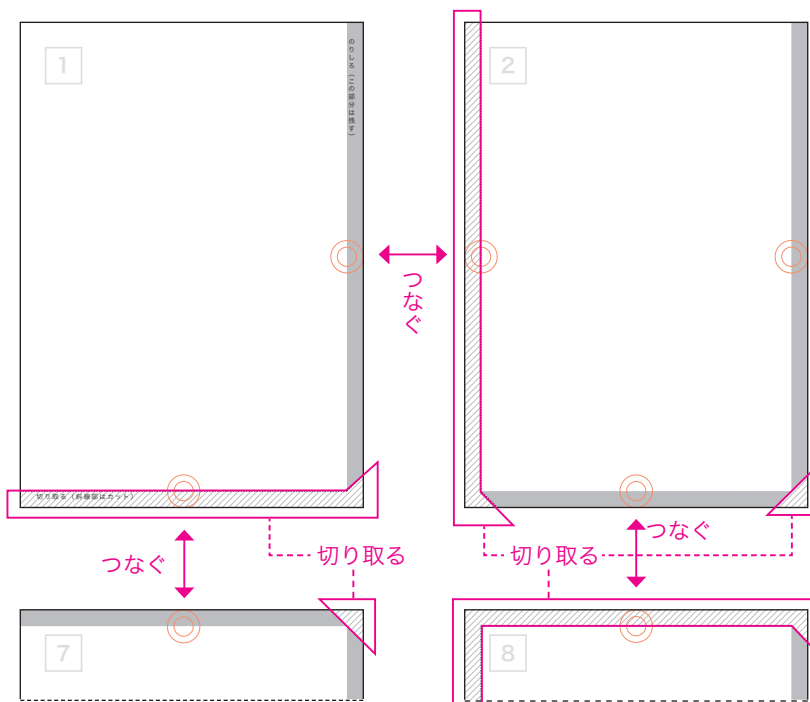

1

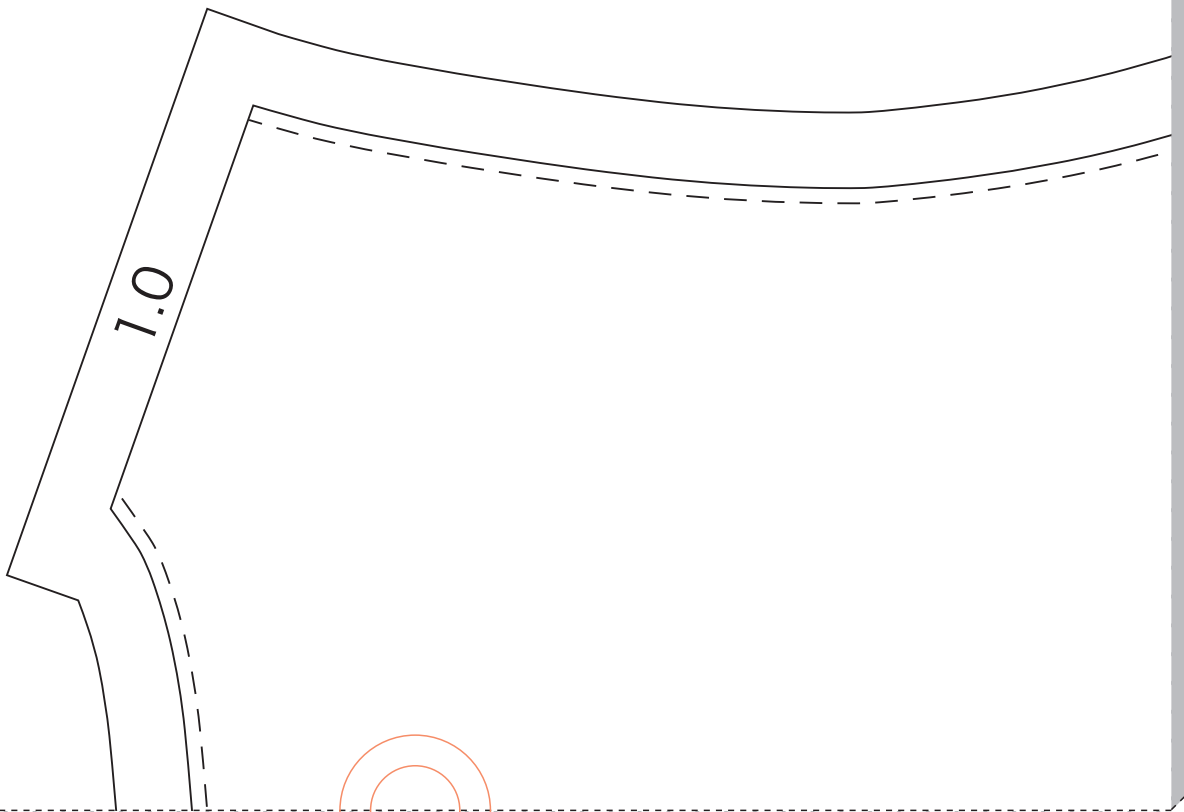

切り取る (斜線部はカット)

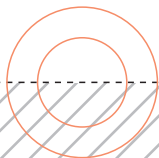

2

fabfab-11

後身頃

size : 9

表×2枚

脇

1.0

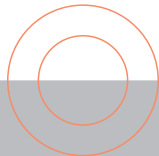
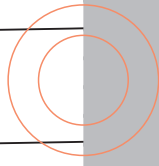
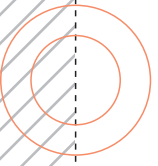

3

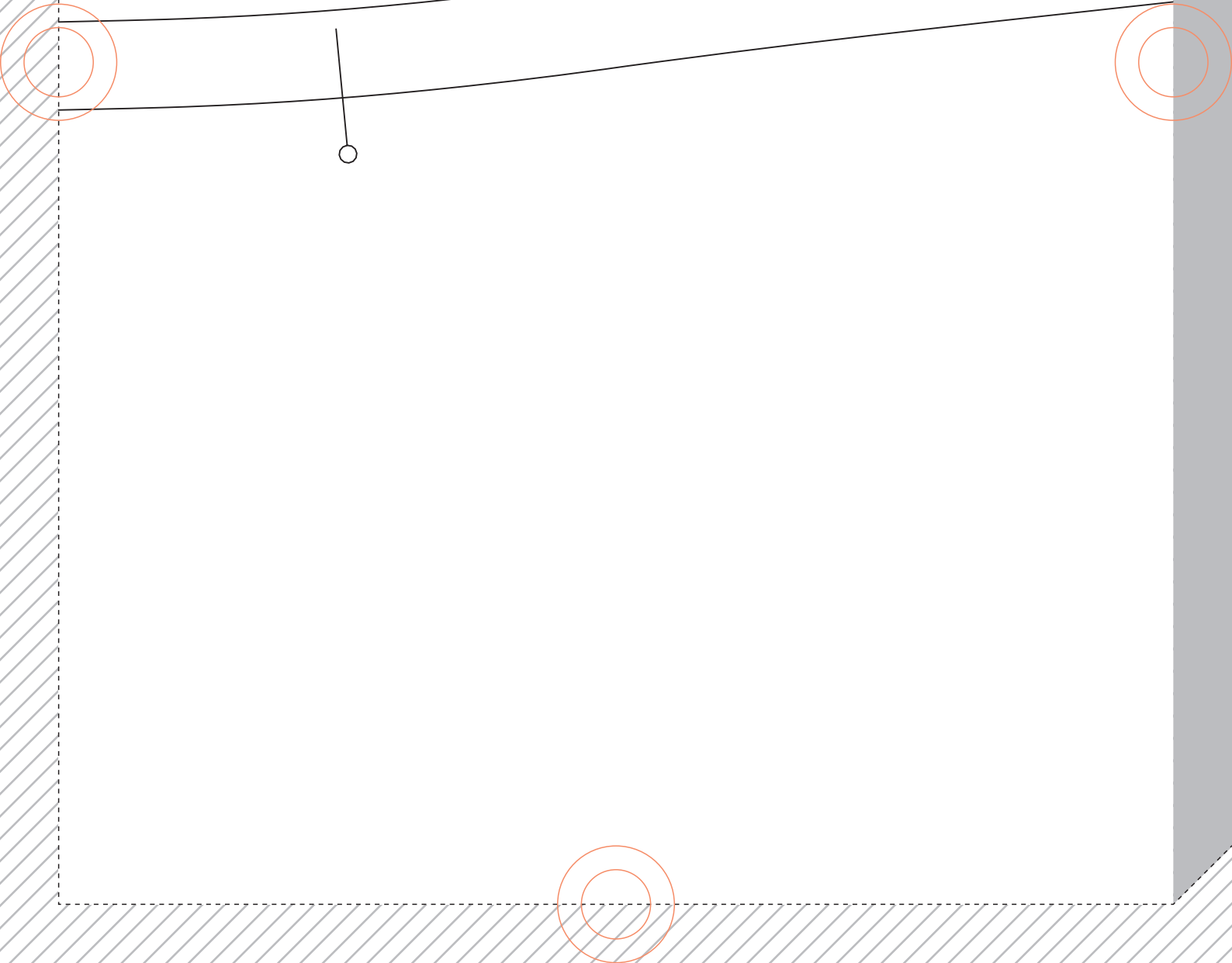

4

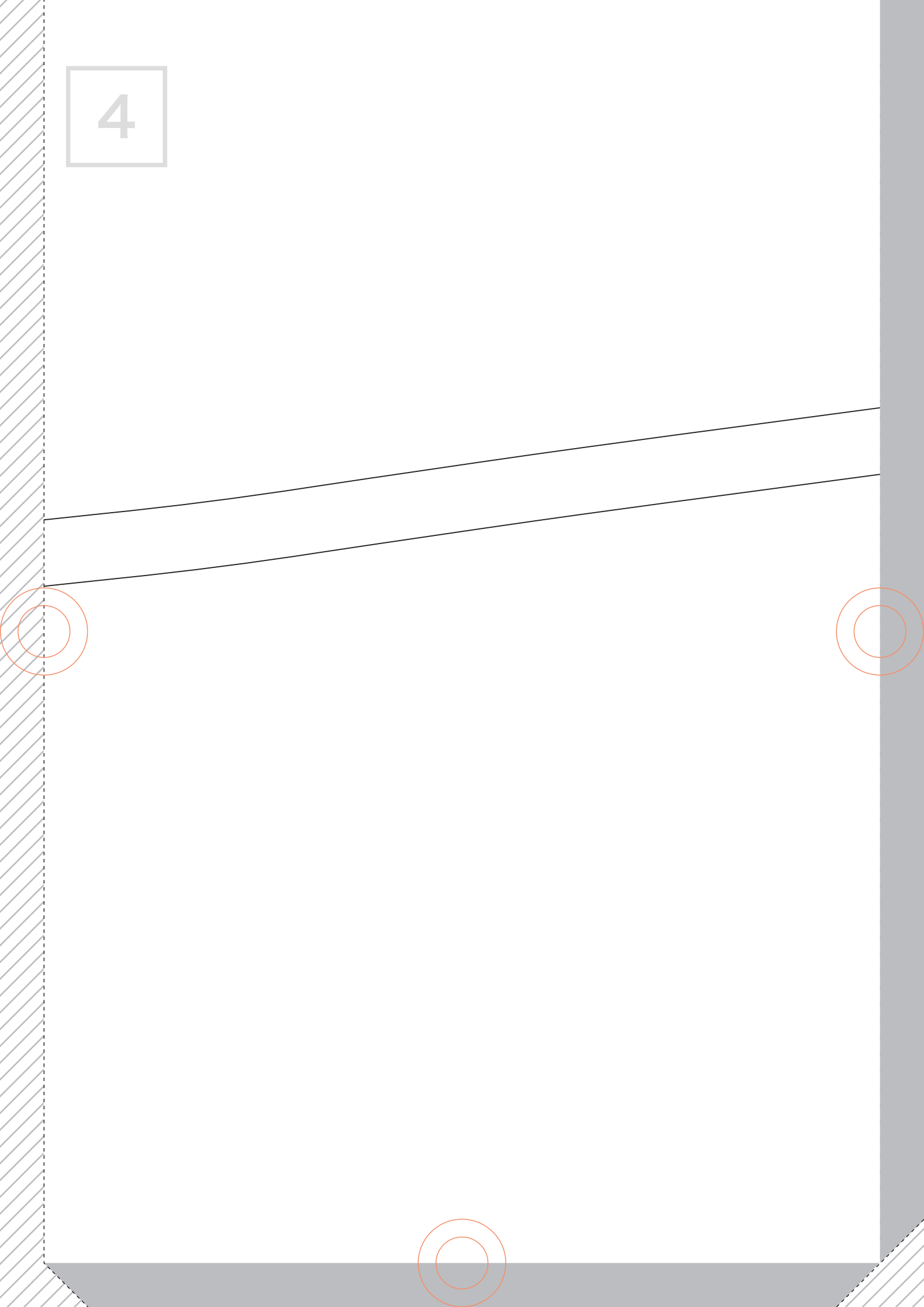
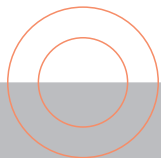
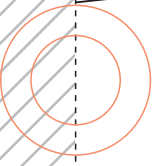

5

1.5

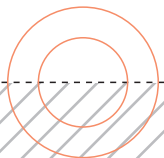
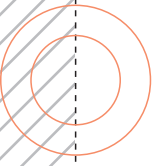

6

2.5cm幅三つ折りステッチ

裾出来上がり線

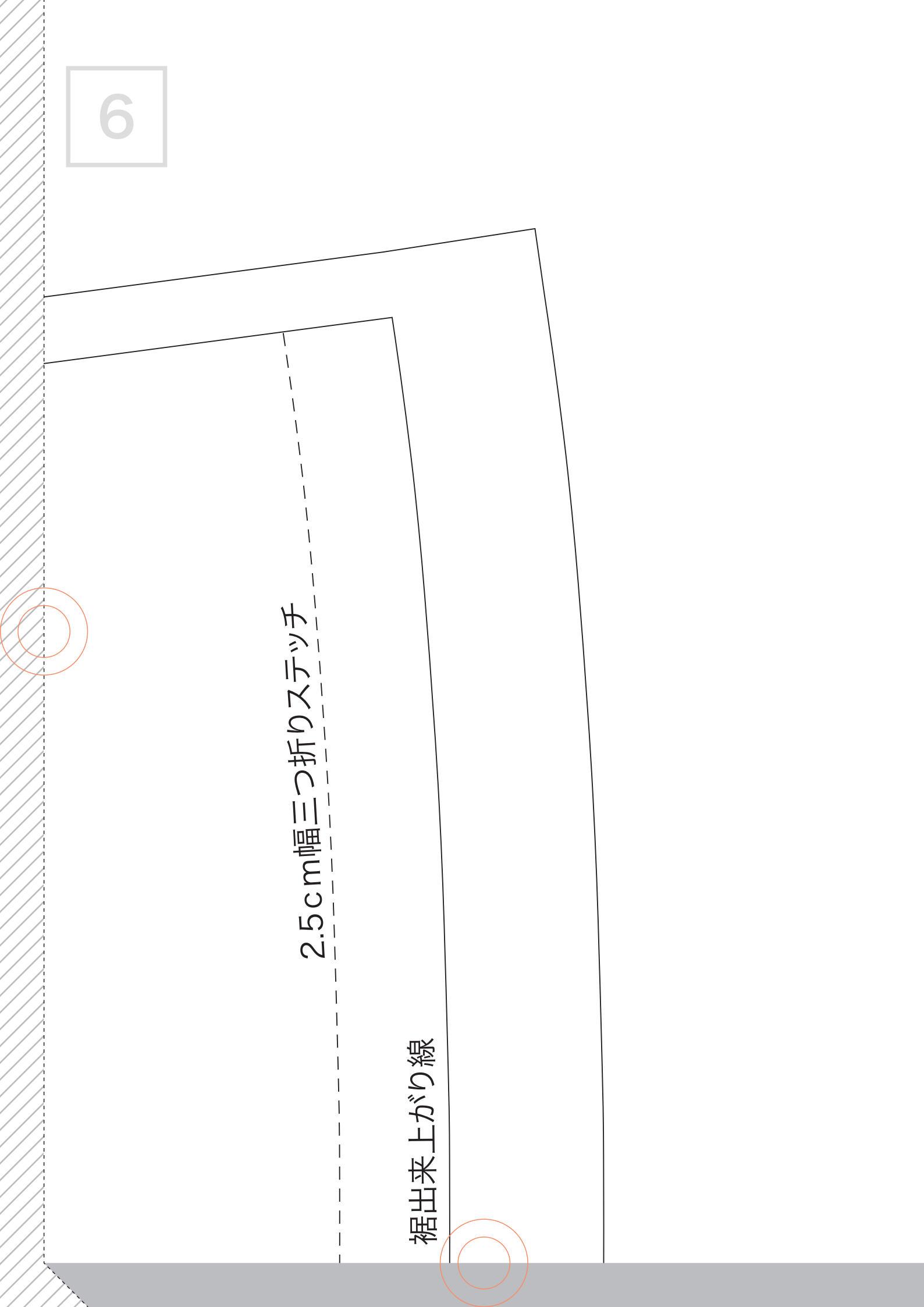

7

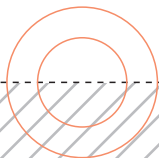
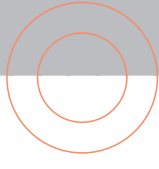
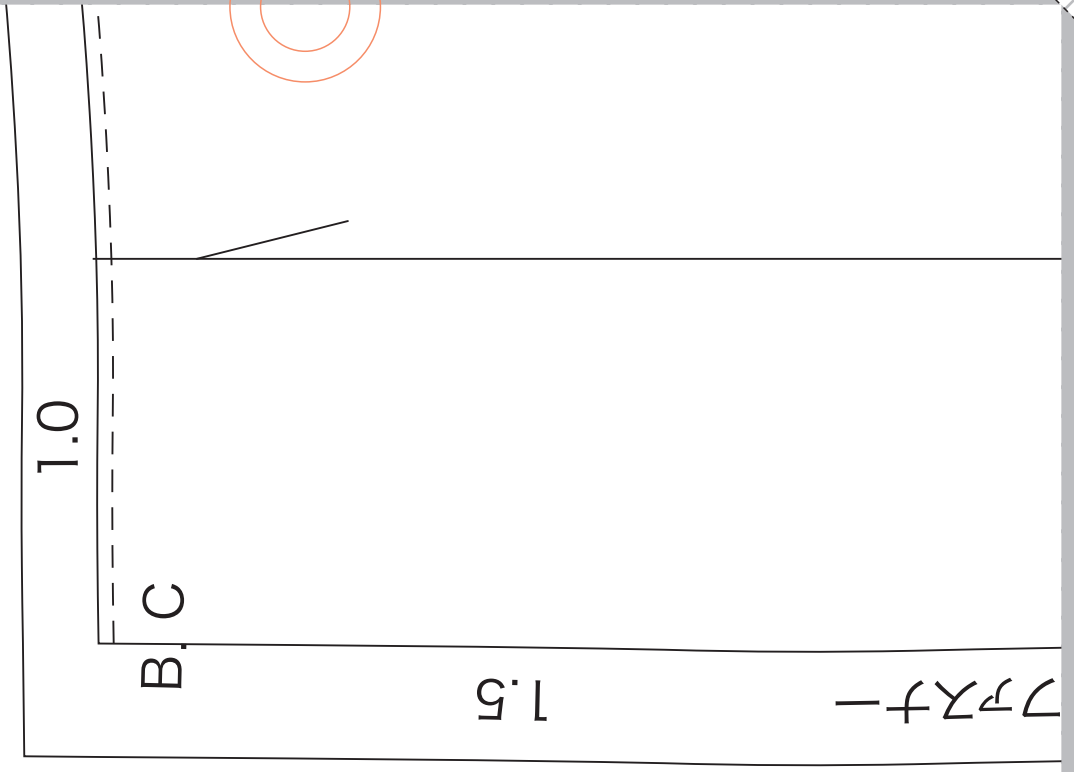



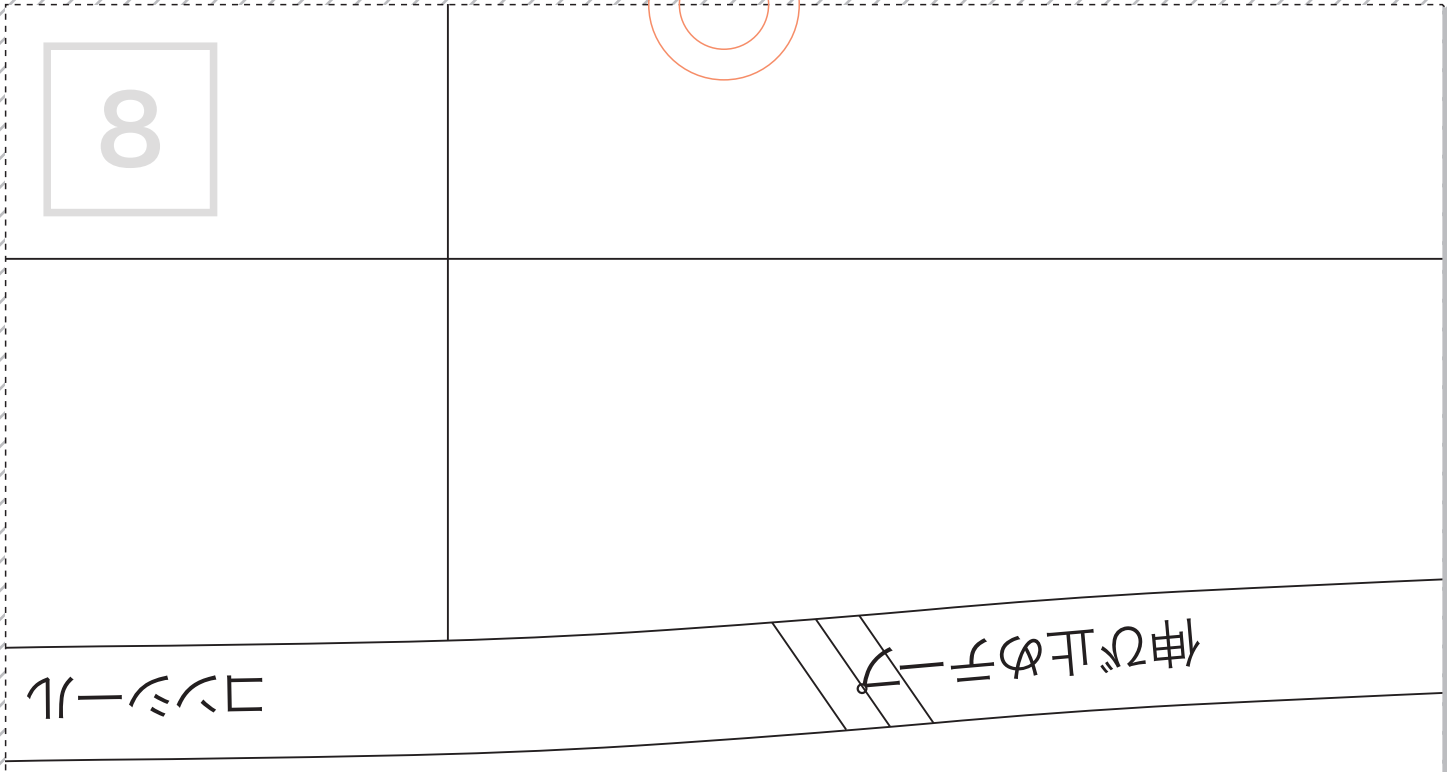

8

コブール

伸び止めフープ

9

地目〇冊

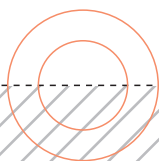
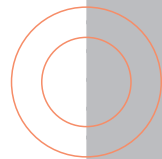
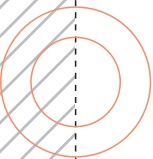
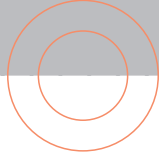

10

▽ ファスナー開き止まり

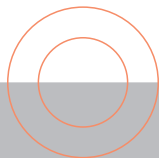
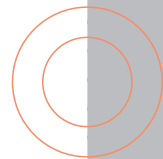
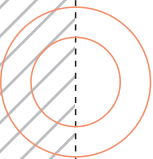
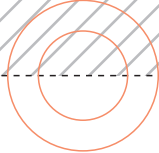

11

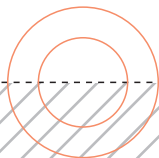
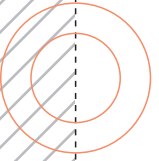
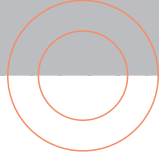

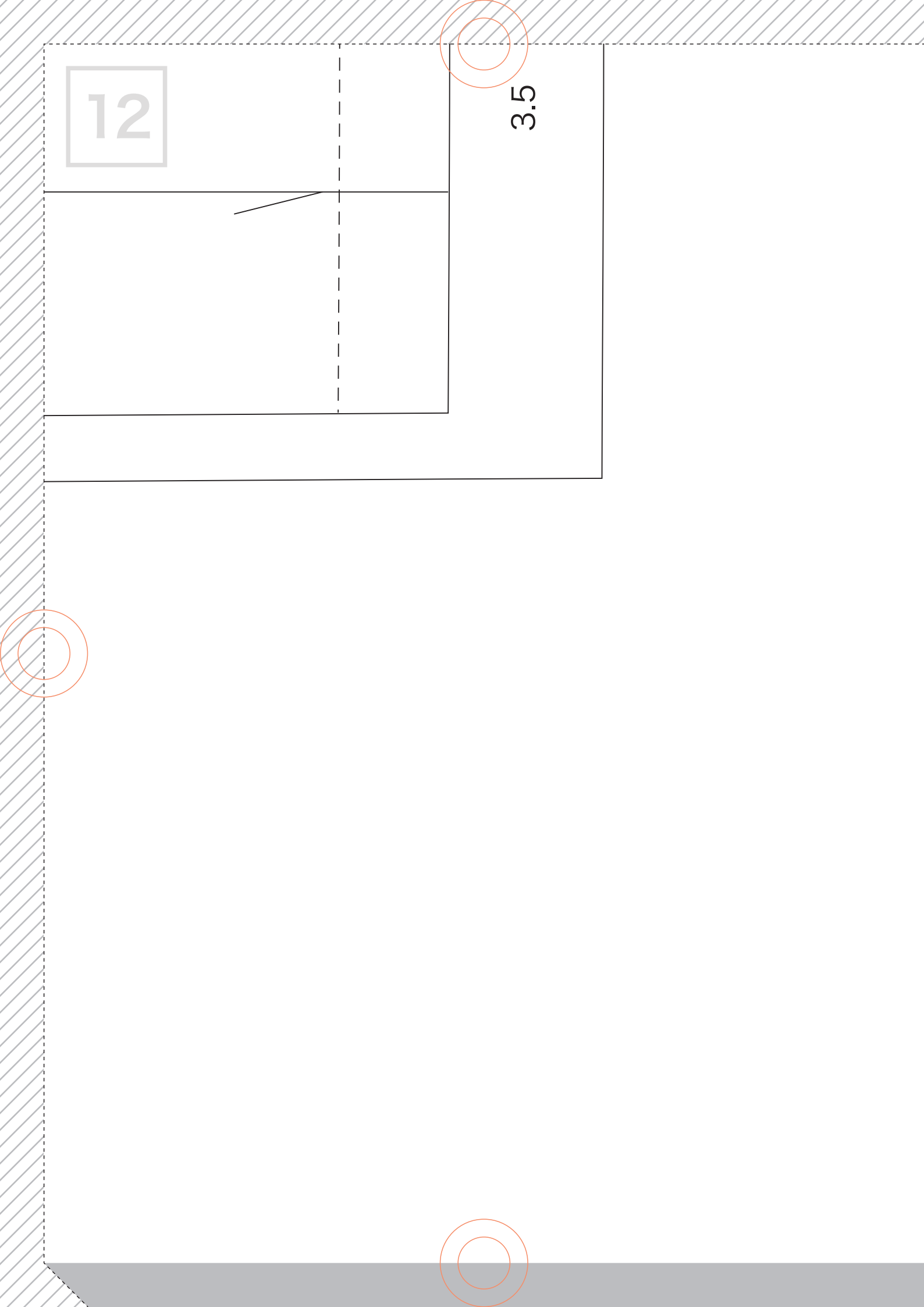

12

3.5

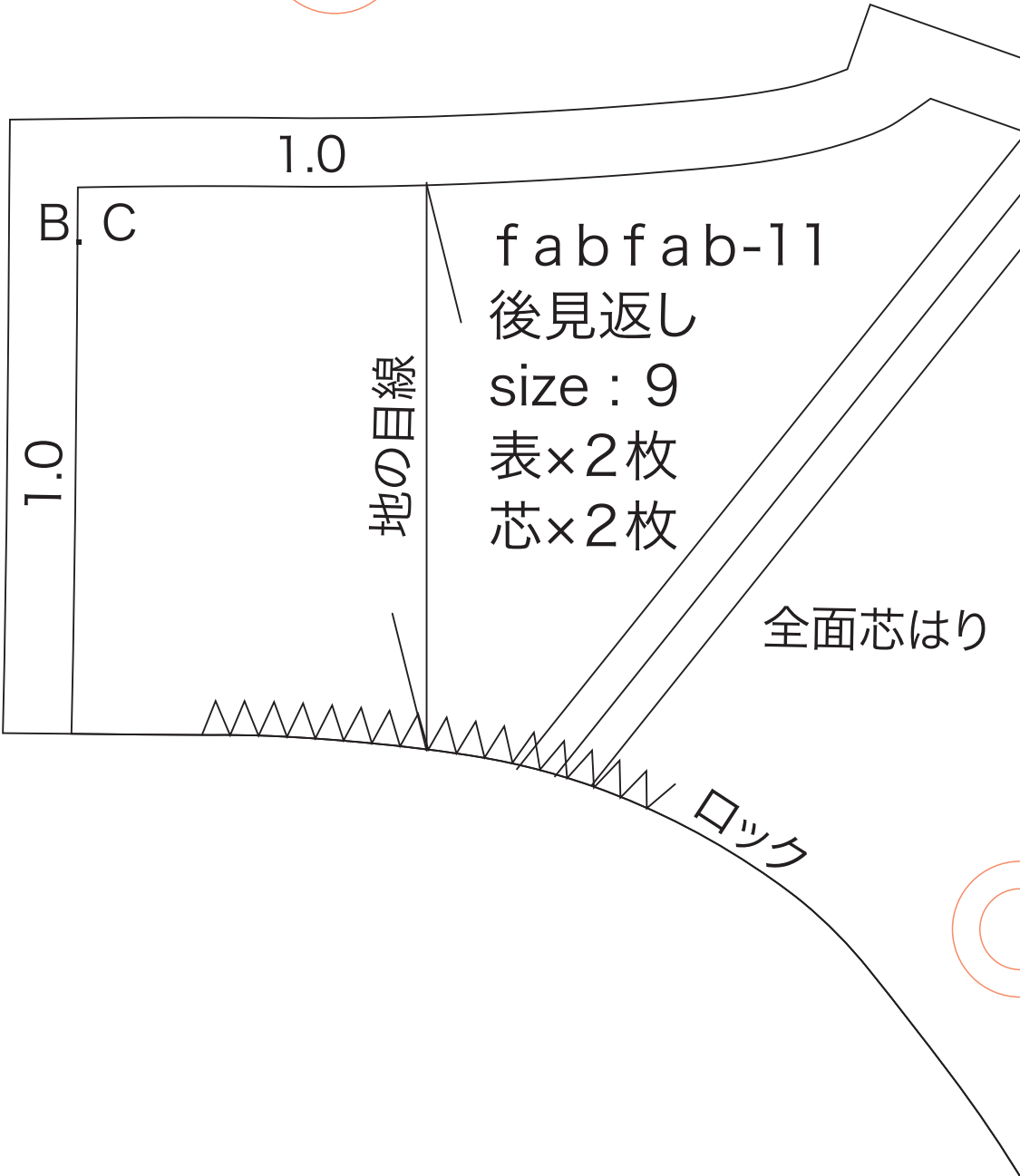

14

1.0

1.0

脇

1.0

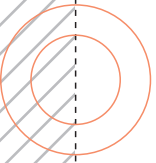
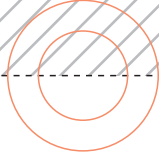

15

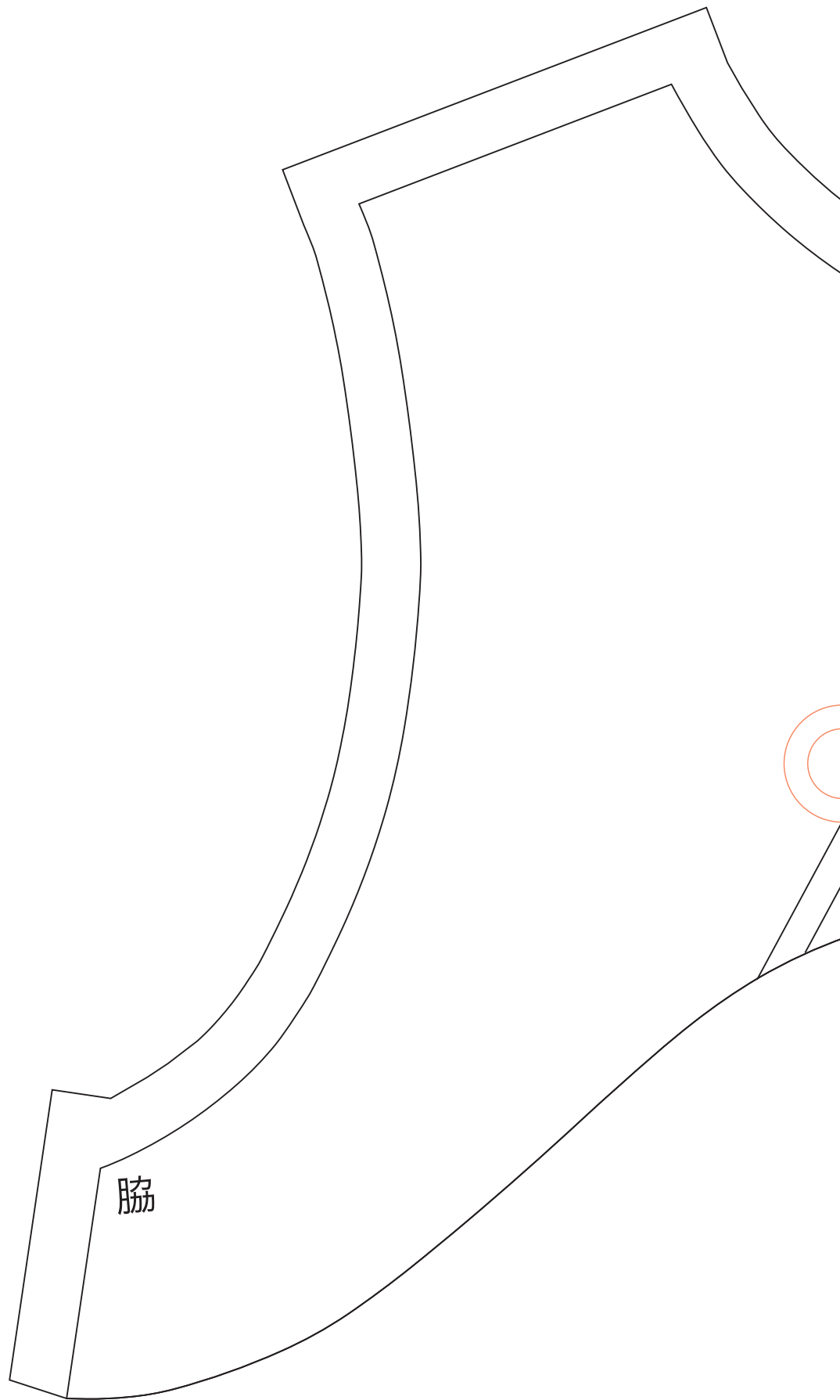



16

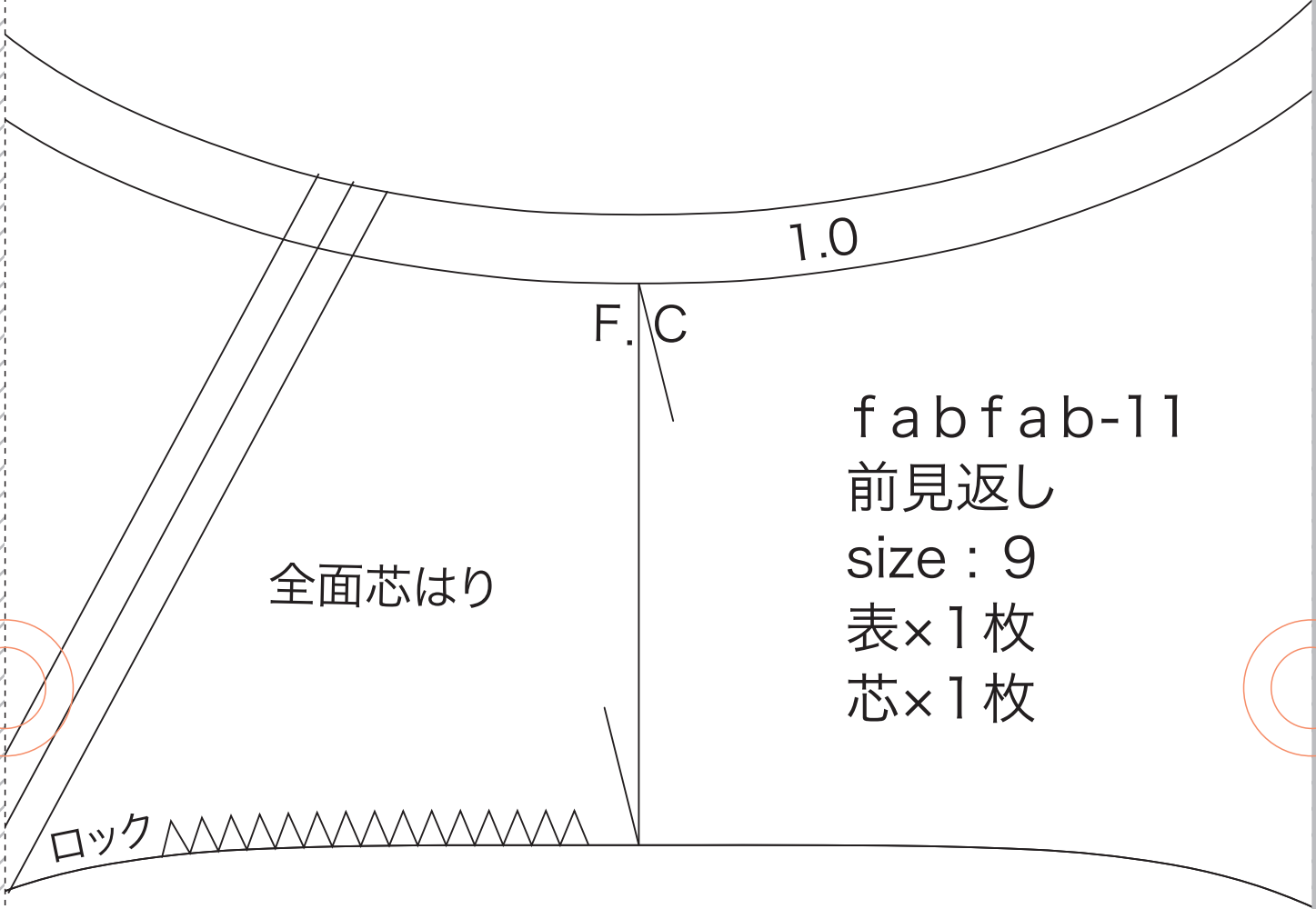
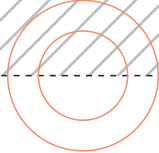

fabfab-11  
前見返し  
size : 9  
表×1枚  
芯×1枚

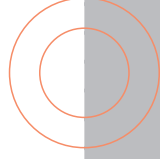
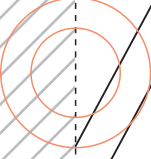

17

1.0

1.0

脇

1.0

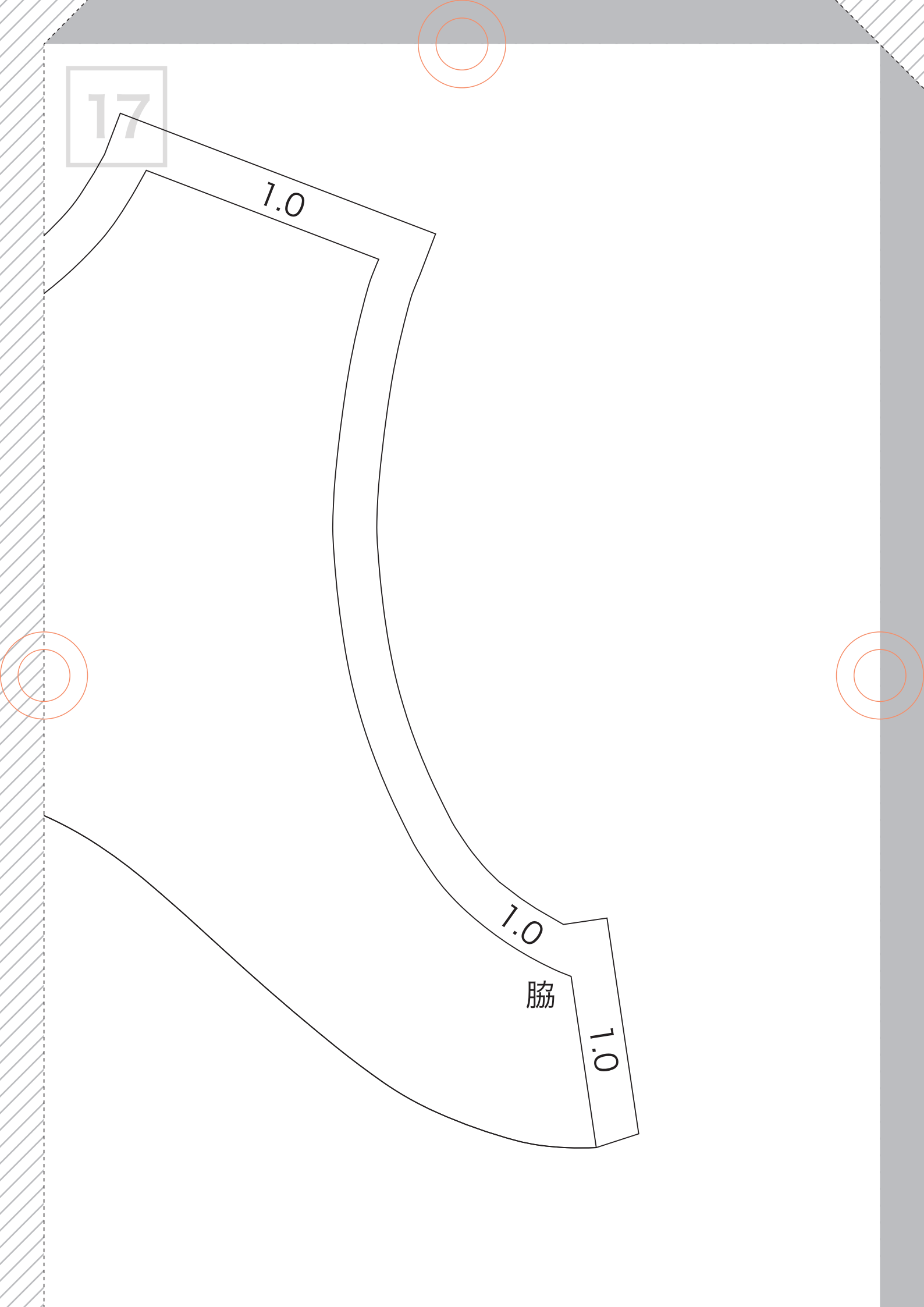

18

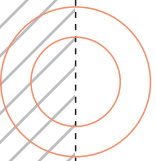
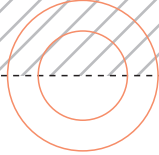

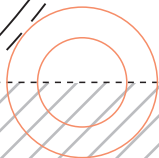
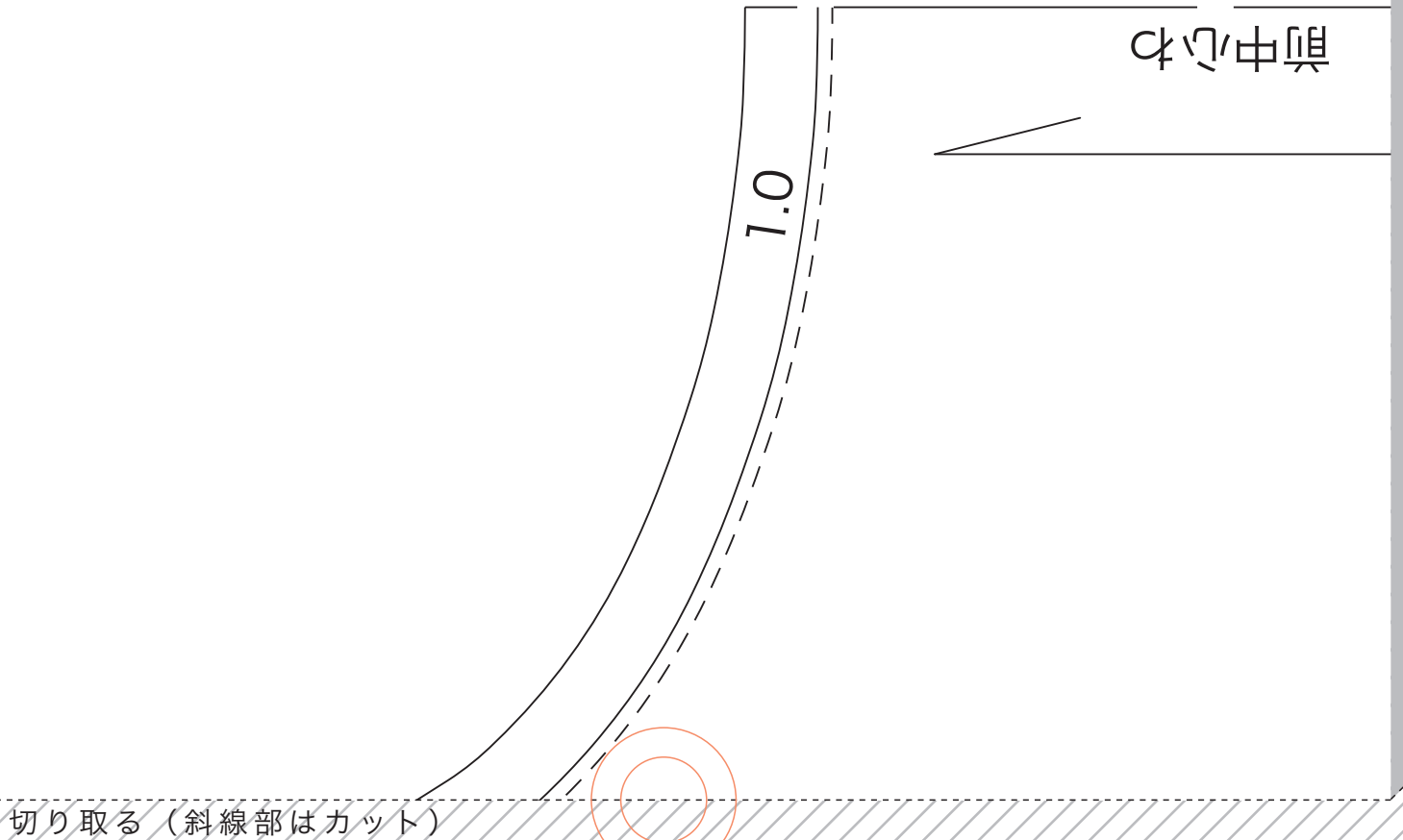

20

fabfab-11

前身頃

size : 9

表×1枚

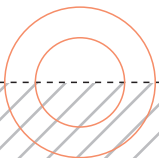
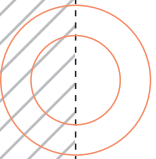

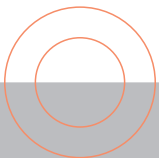
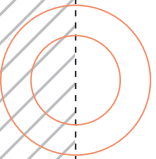

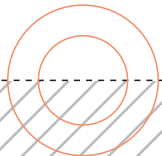
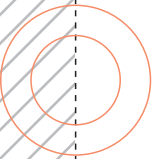



24

2.5cm幅三つ折りステッチ

3.5

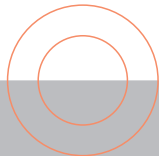
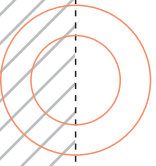

25

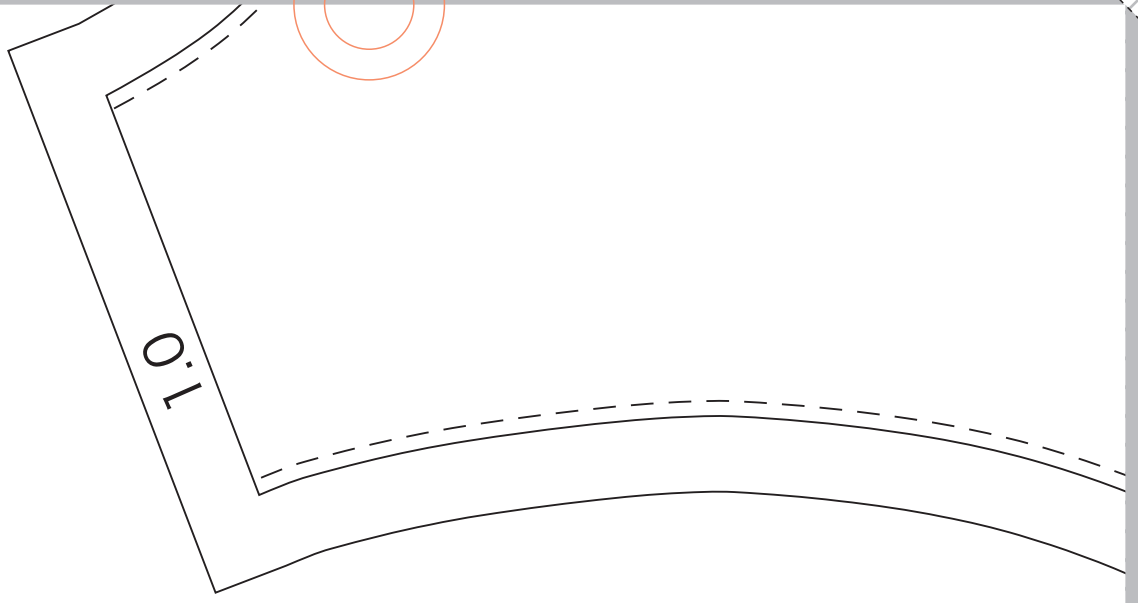

26

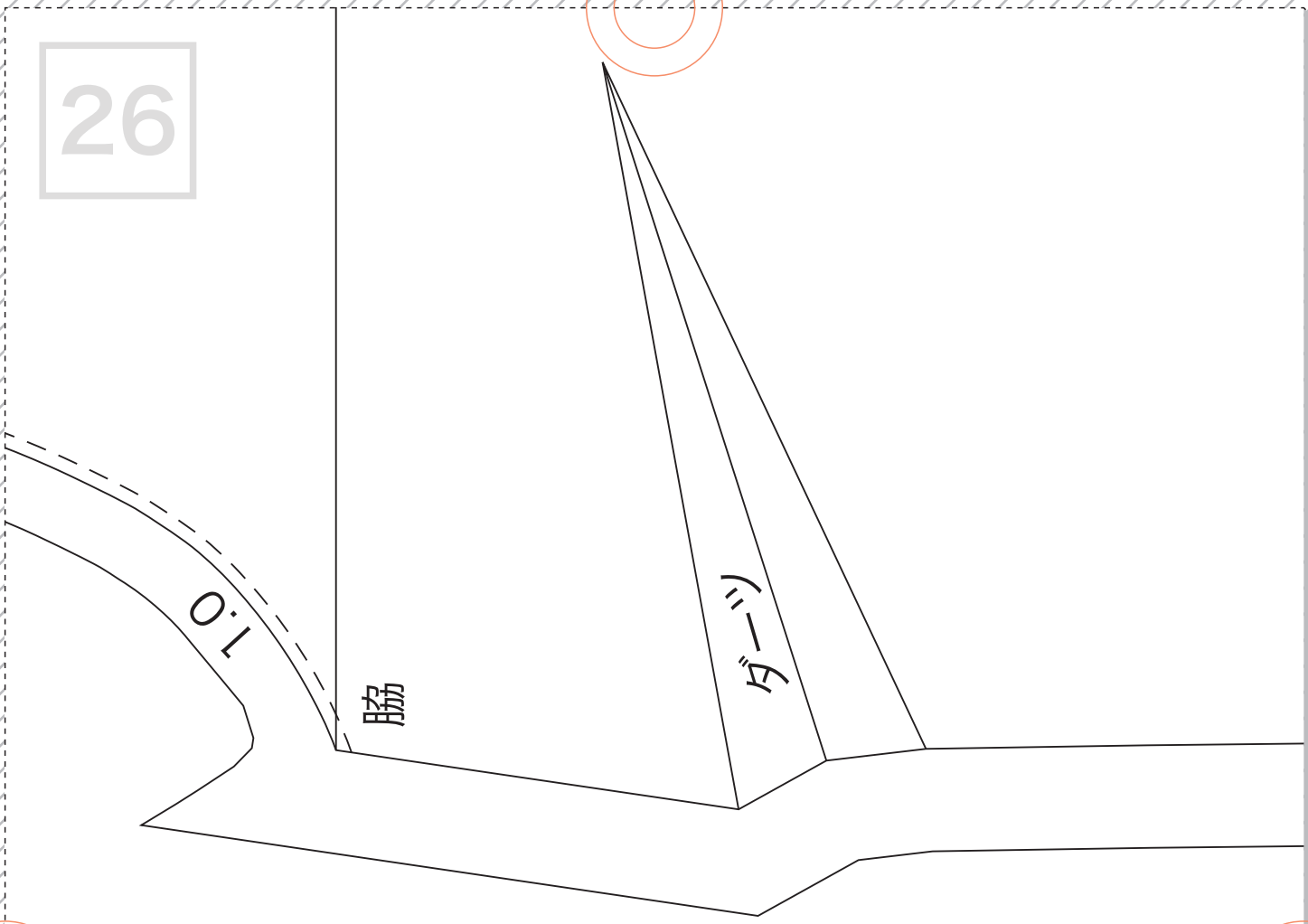

10

脇

ダミー

27

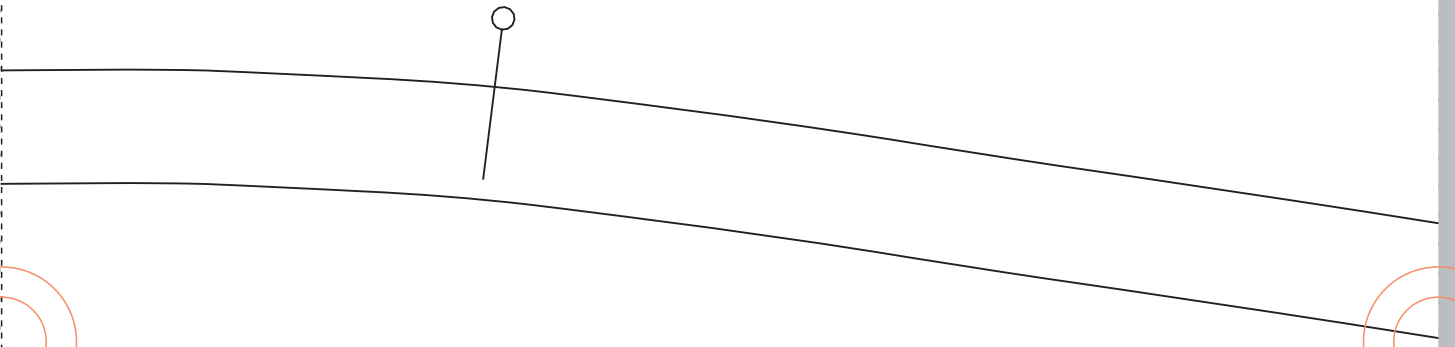
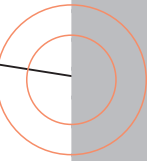
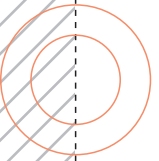
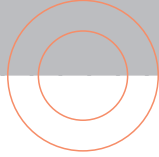

28

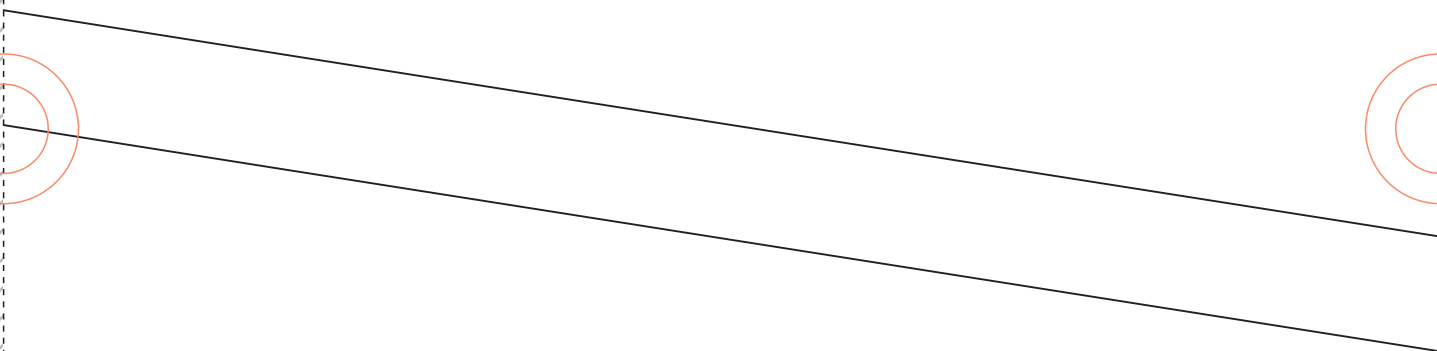
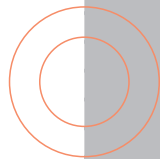
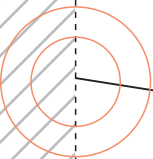
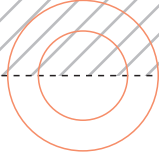

29

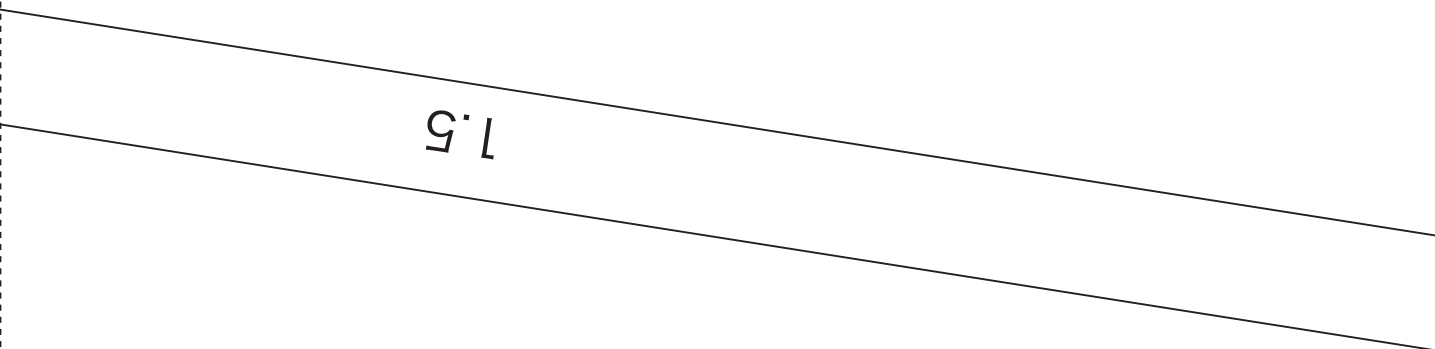
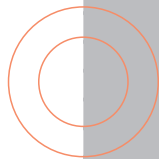
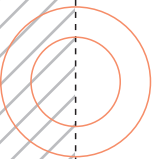
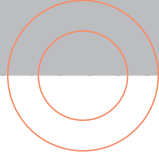

30

裾出来上がり線

