

introduction はじめに

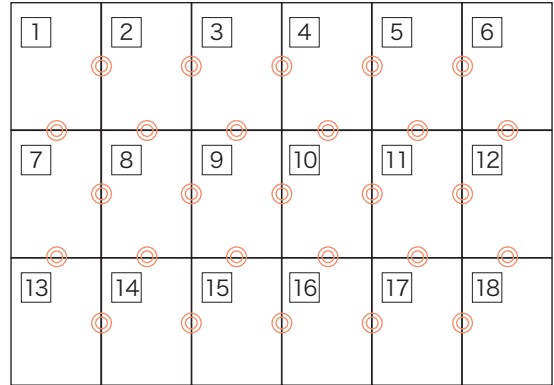

パターンは A4 サイズ 27 枚に分割されています。
印刷後、右図のようにつなぎ合わせてください。

! 印刷時の注意

印刷設定では、「ページの拡大や縮小」を選択せず
必ず、「実際のサイズ」(原寸) で印刷してください。



how to make パターンのつくりかた

STEP1 斜線部分  は切り取り、灰色部分  は残してのりしろにします。
(斜線と灰色を間違えないように注意)

STEP2 各用紙の番号を確認し、 の位置を合わせて、
のりづけします。
(水のりは用紙が波打ちます。スティック糊などをお使いください)

STEP3 それぞれのパーツをハサミで切り出します。

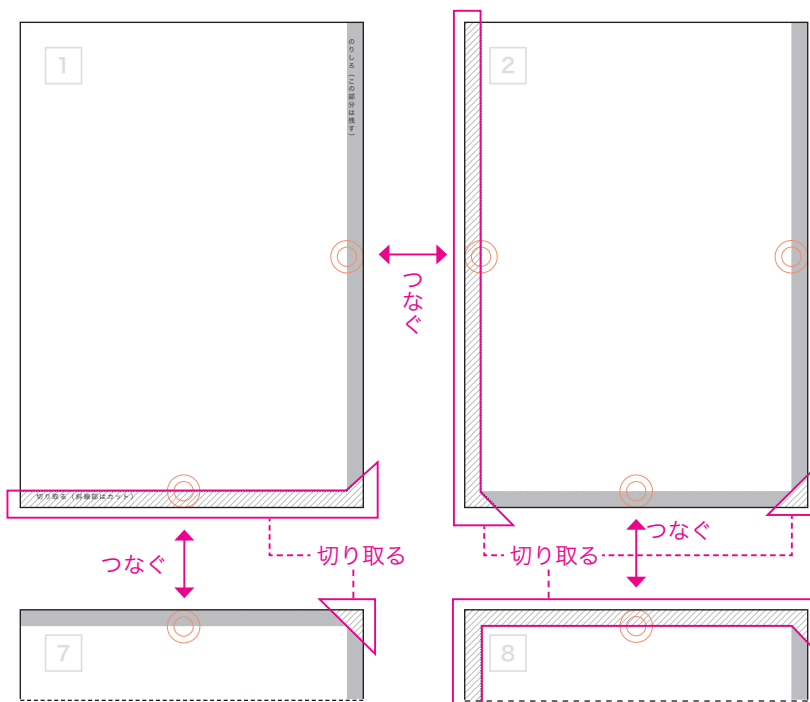
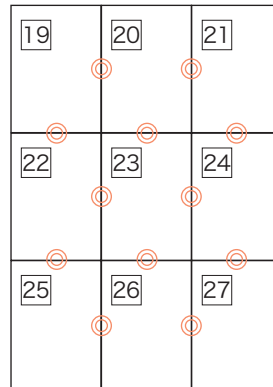

1

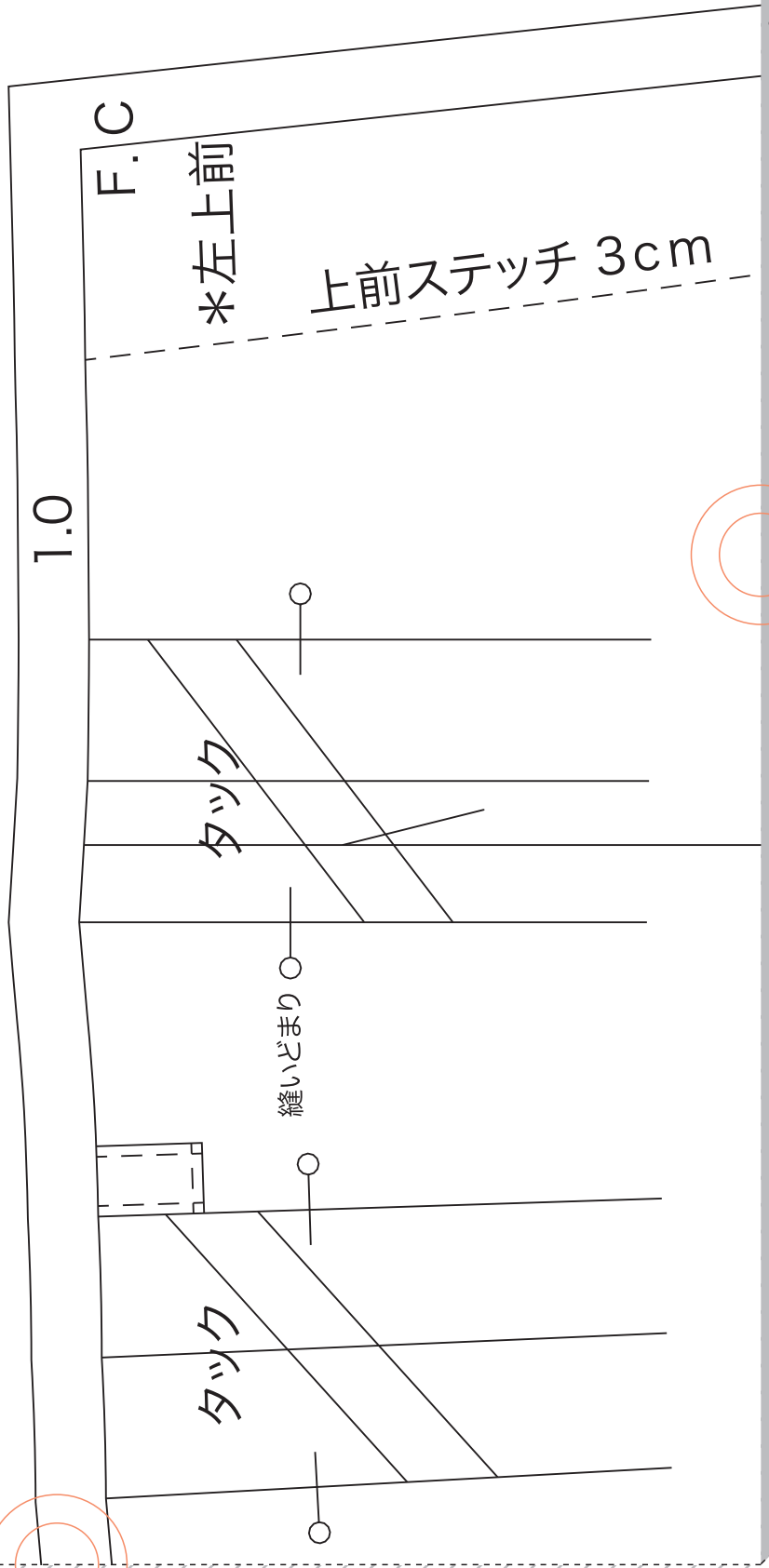

切り取る (斜線部はカット)

2

1.0

ファスナー開きどまり

タックの方向

fabfab-12
前パンツ
size : 7
表×2枚

3

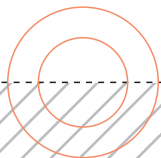
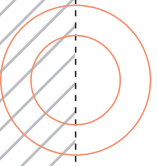

4

地目線

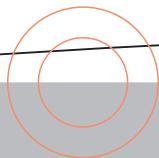
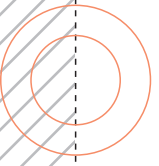

5

1.0

2cm幅三つ折りステッチ

1.0

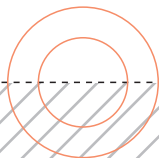
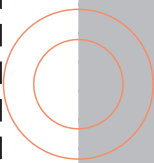
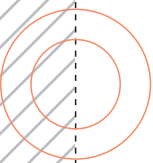

6

3.0

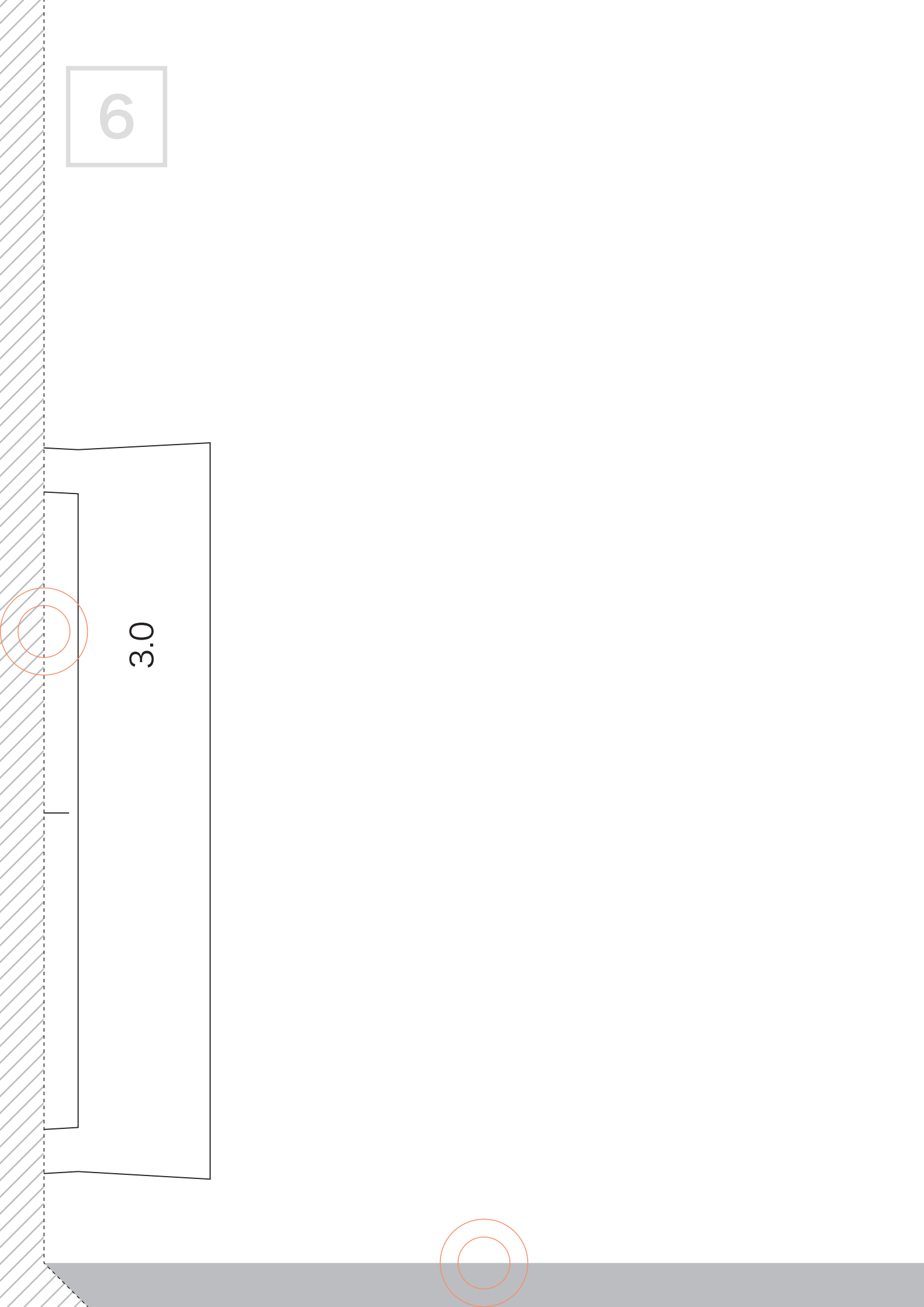

7

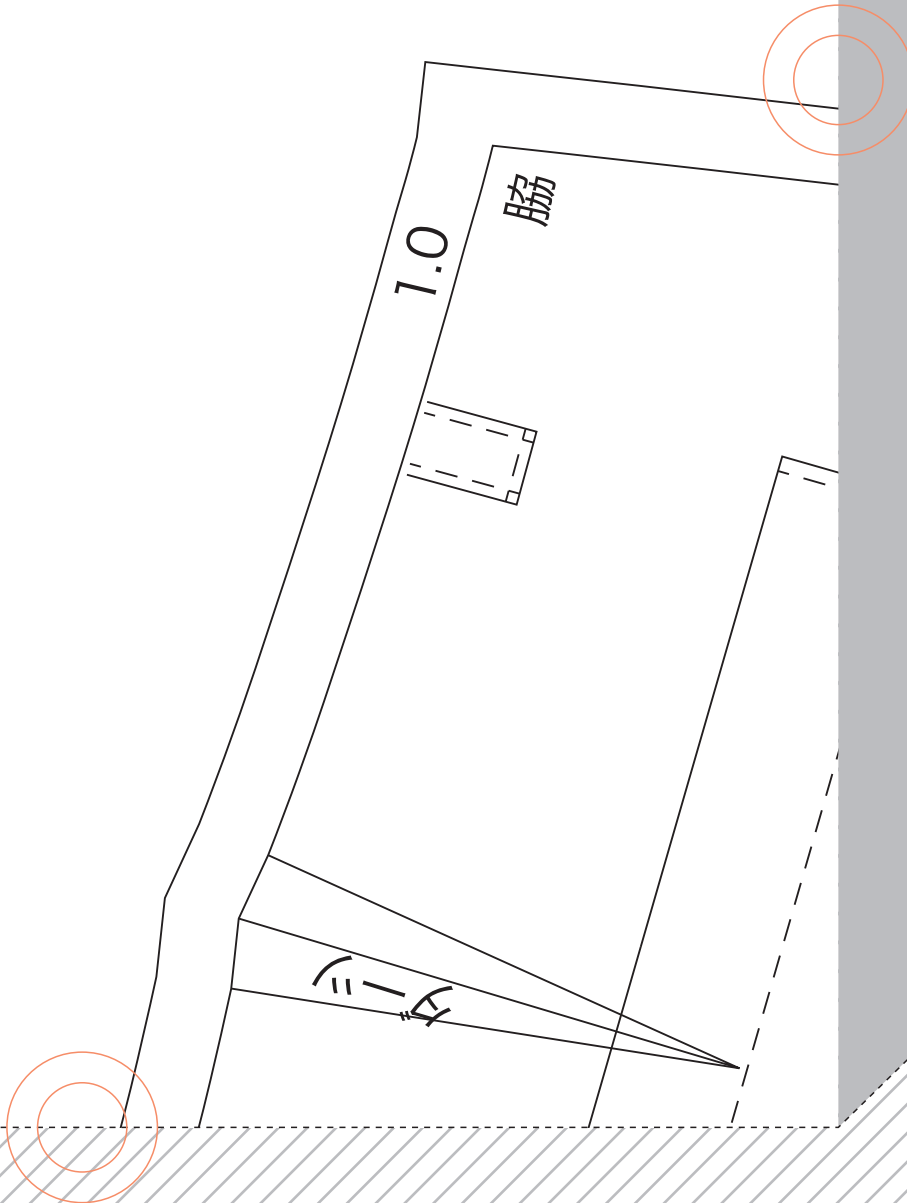
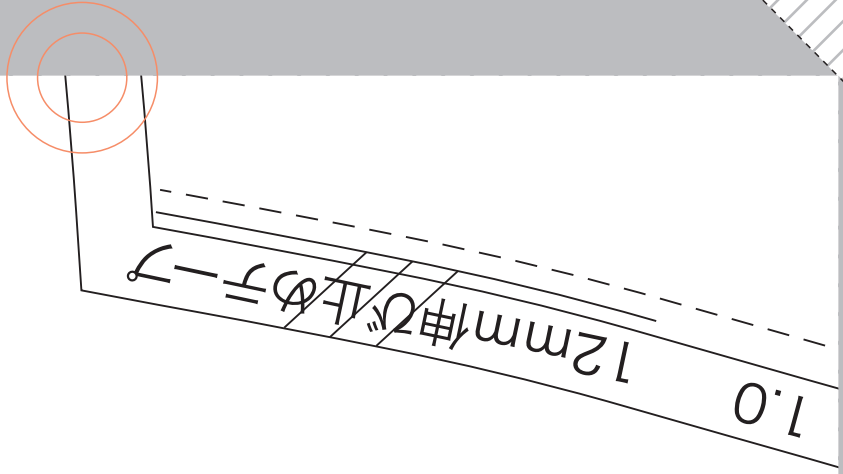

8

ホケツト□

脇

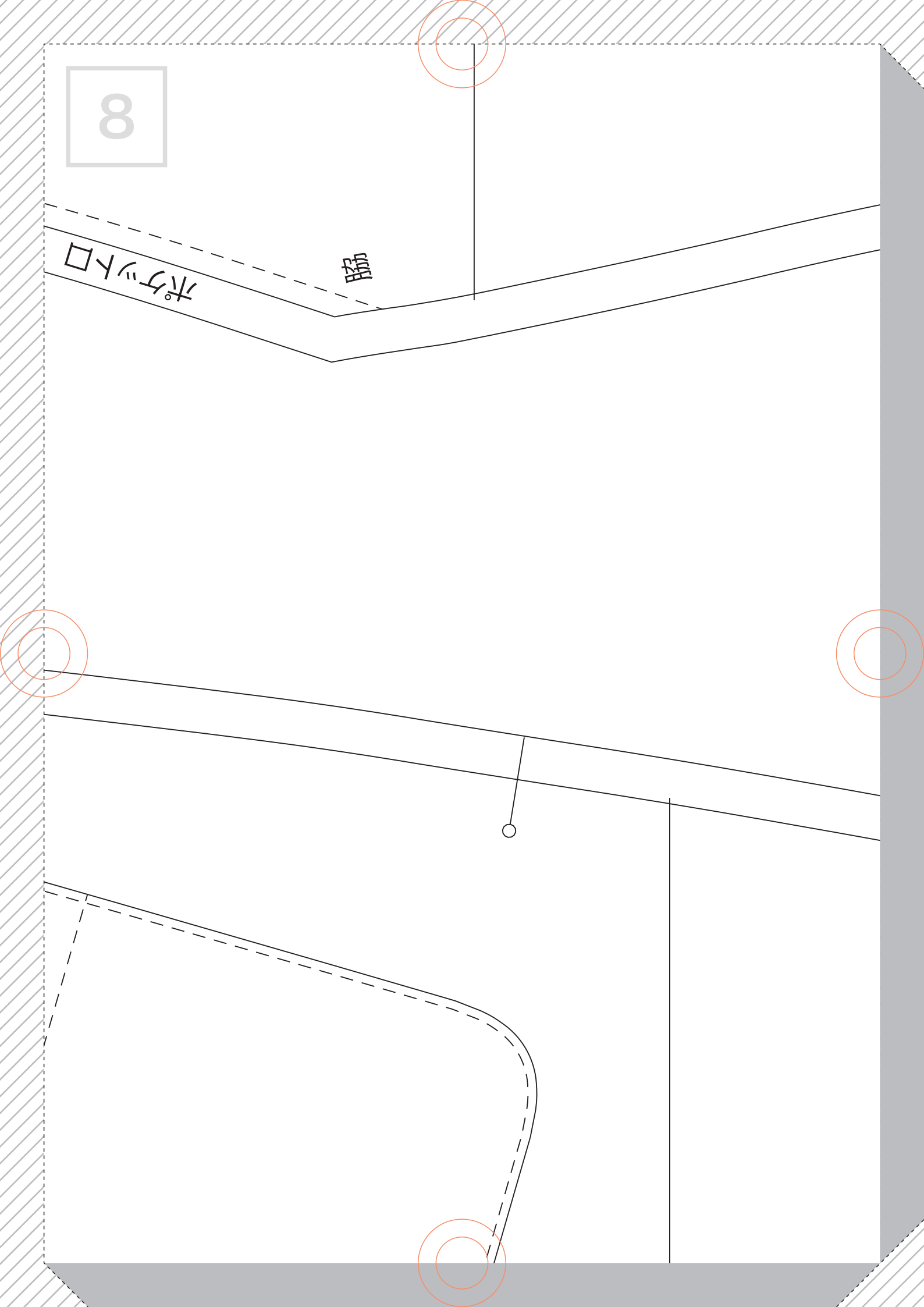

9

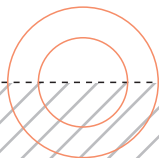
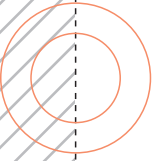
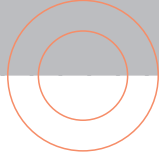

10

ロック片倒し(後高)

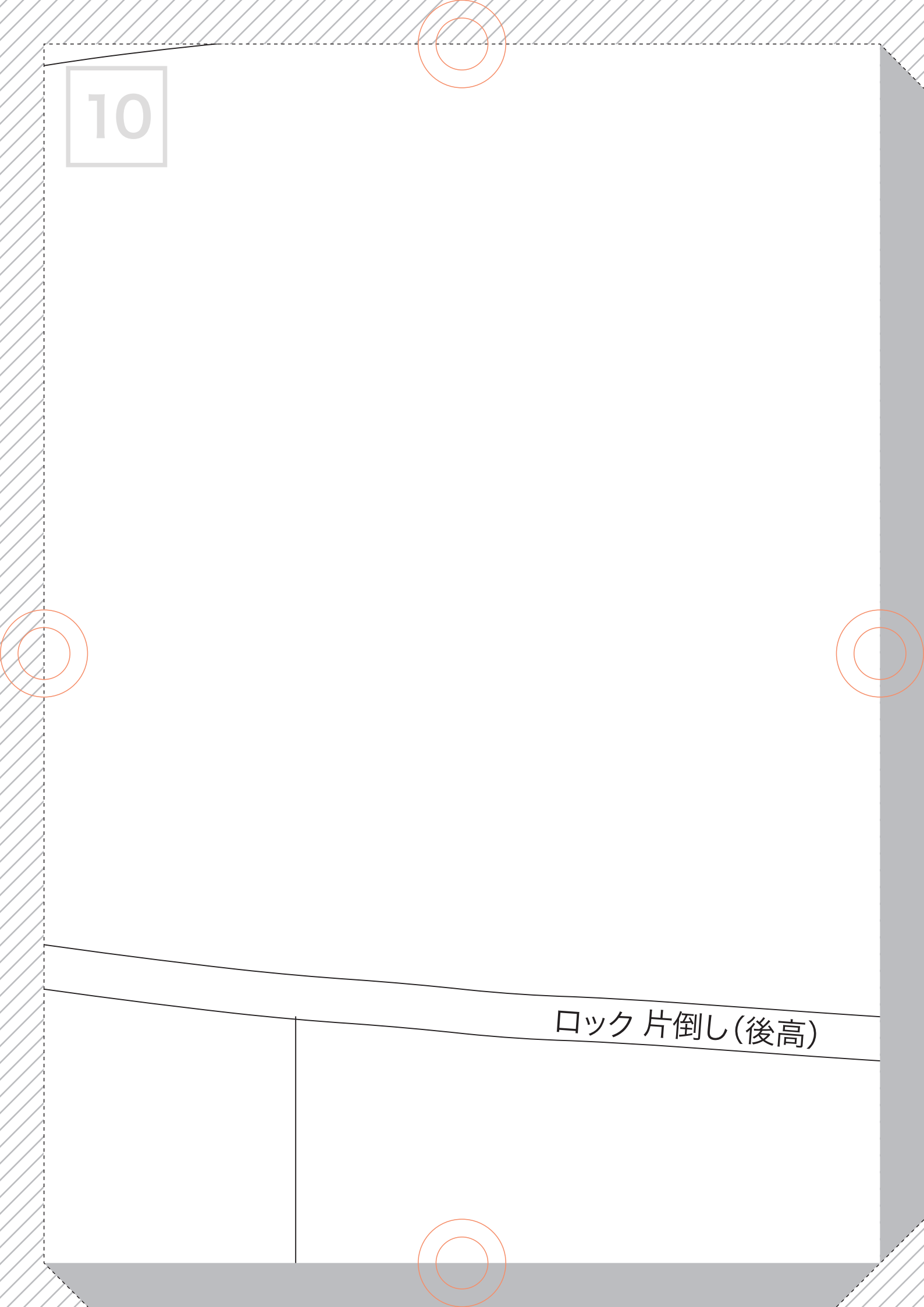

11

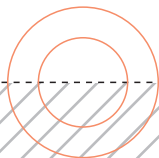
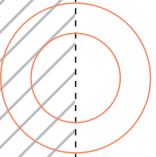
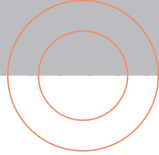

1.0

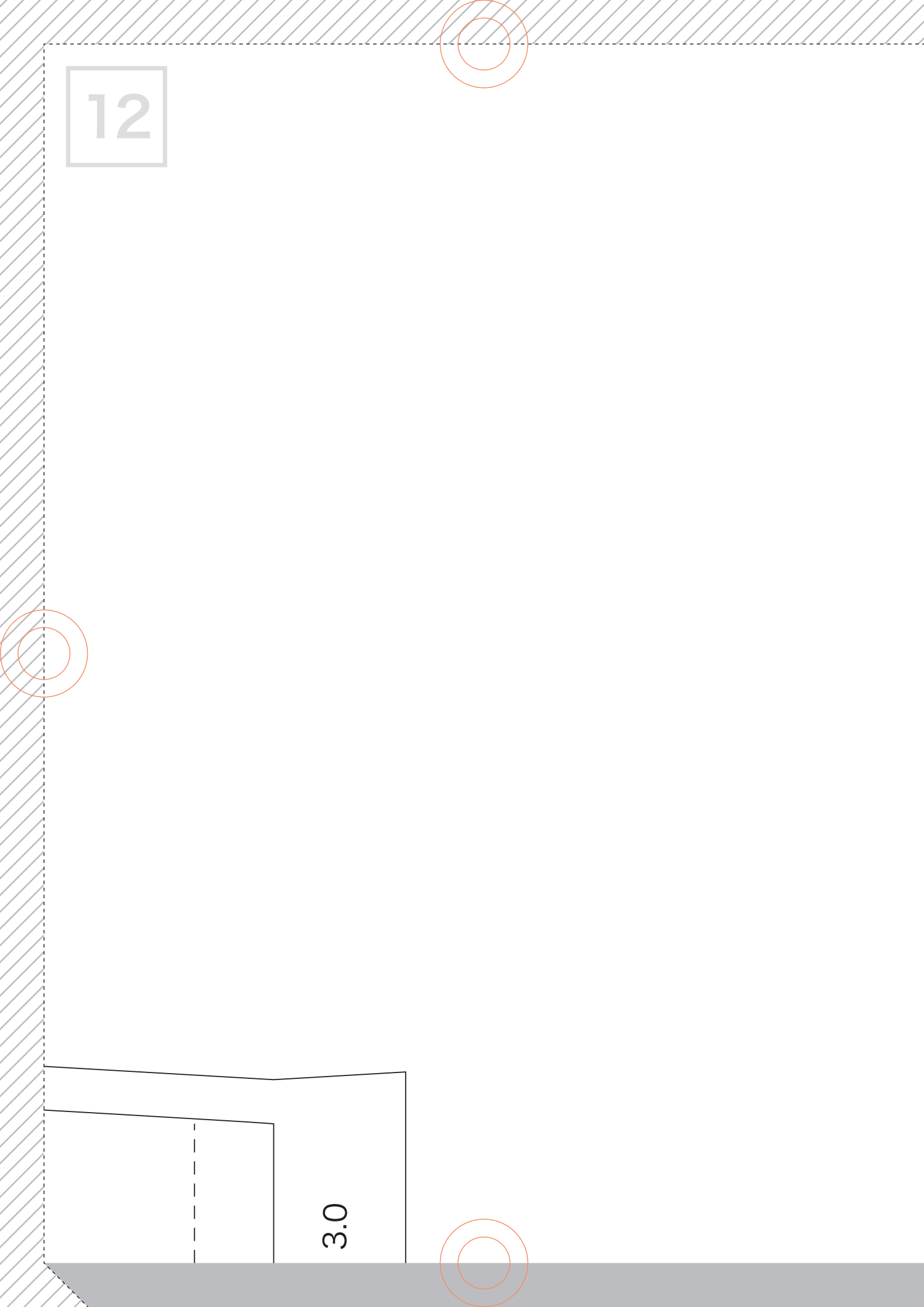

12

3.0

13

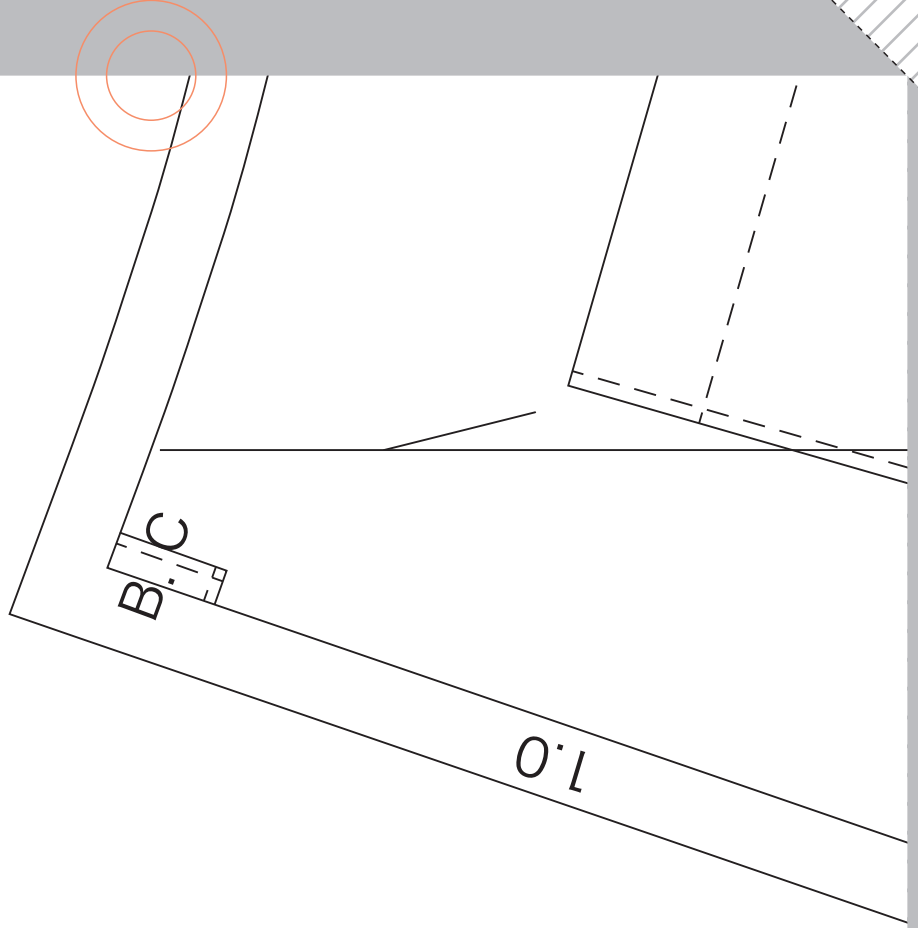

14

ホケット位置

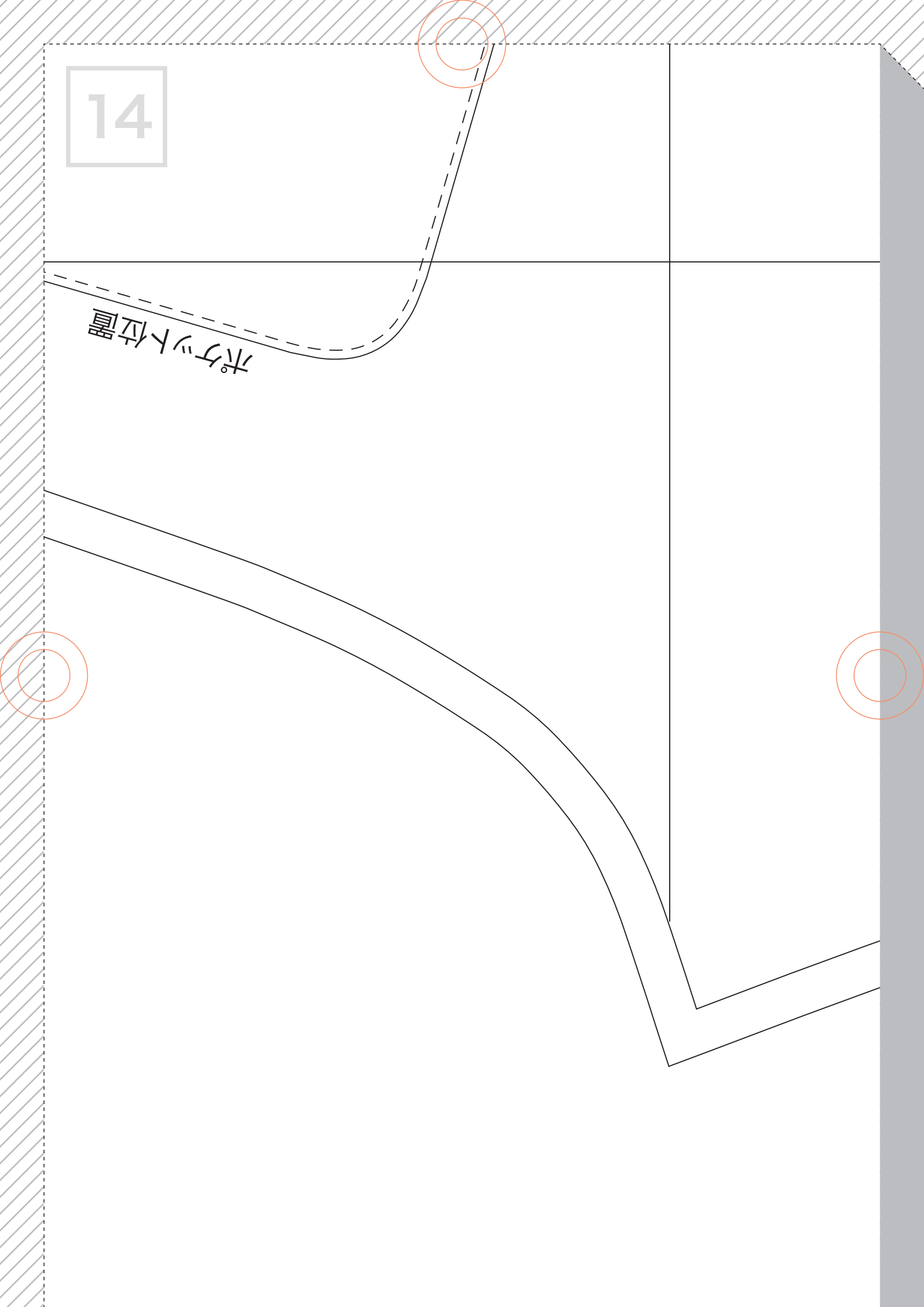

15

fabfab-12

後パンツ

size: 7

表×2枚

16

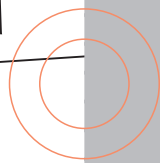
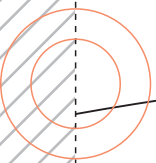
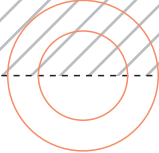

ロック片倒し(後高)

17

地の目線

1.0

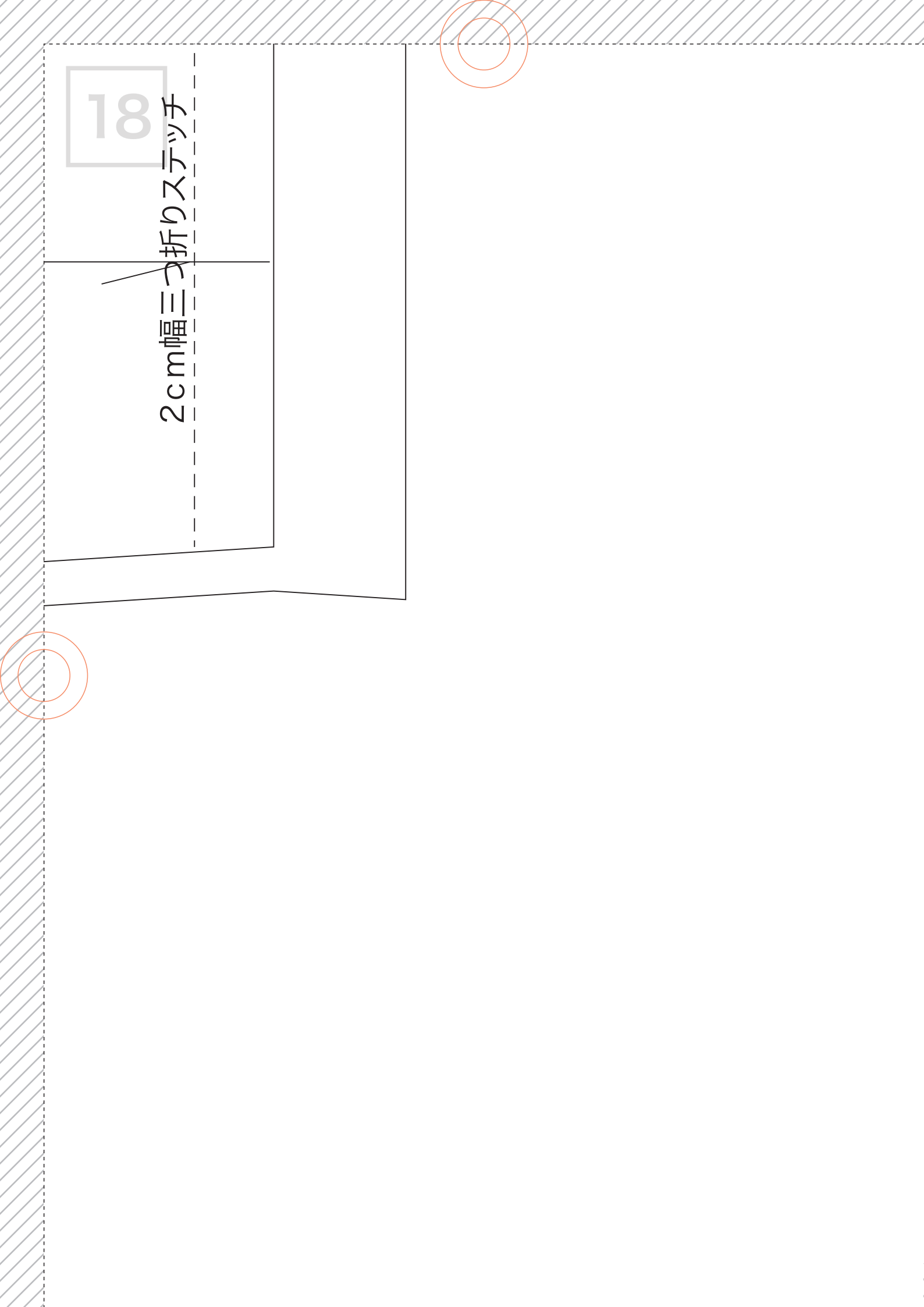

18

2cm幅三つ折りステッチ

19

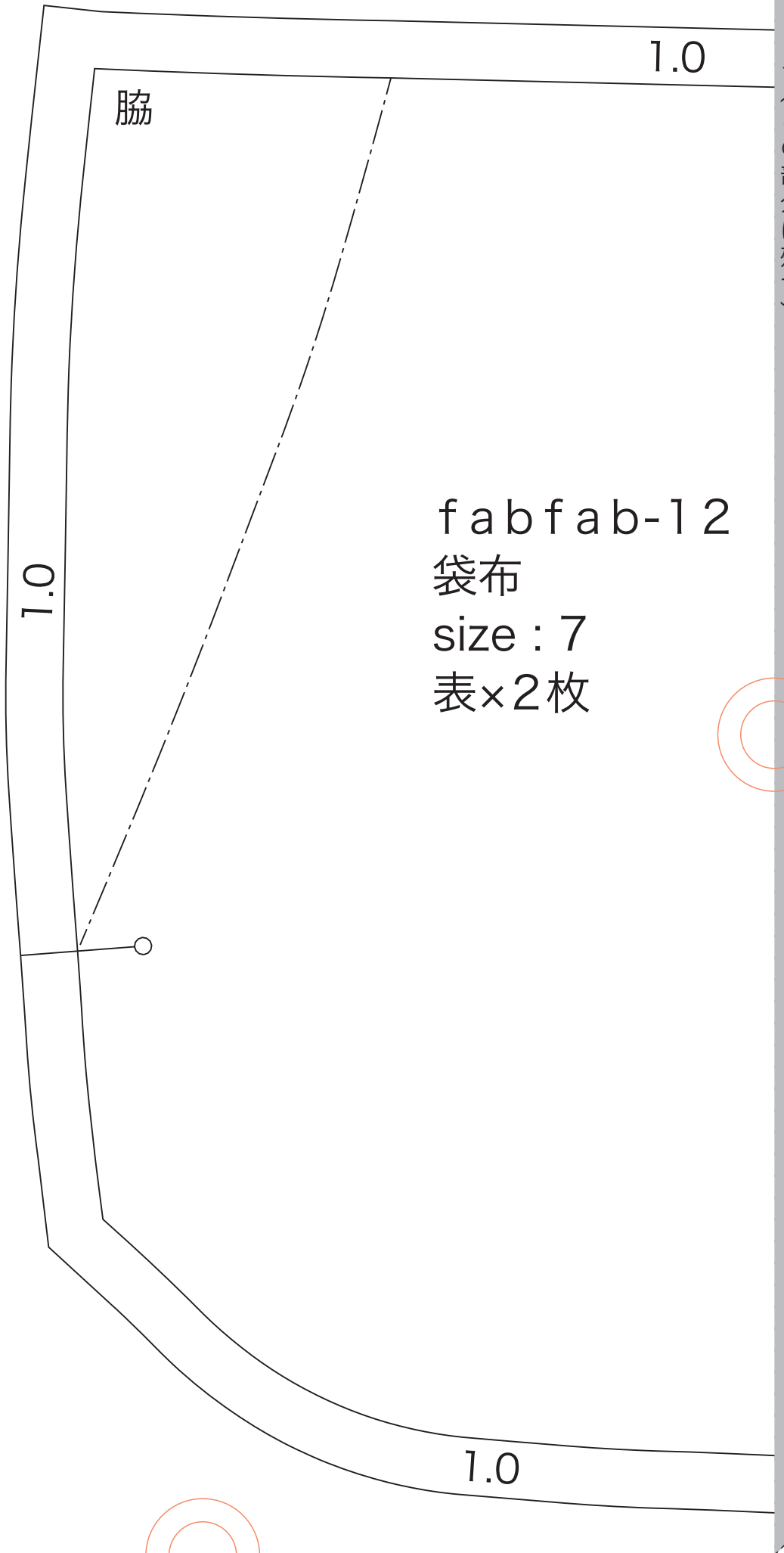

fabfab-12
袋布
size : 7
表×2枚

切り取る (斜線部はカット)

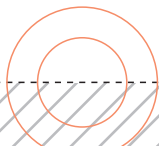

20

1.0

折山線

地の目線

前パンクポイントロと接ビ

ロック

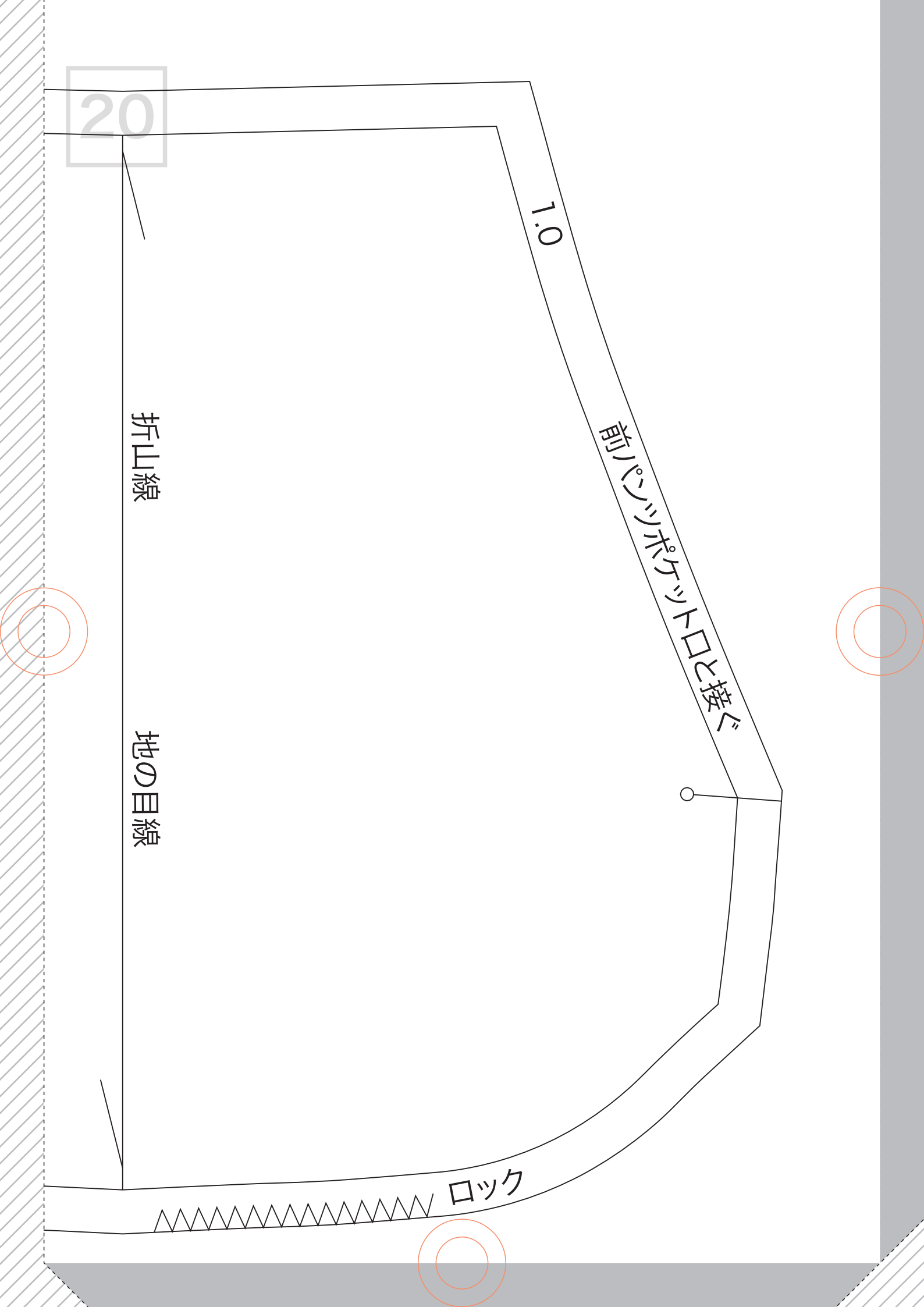

21

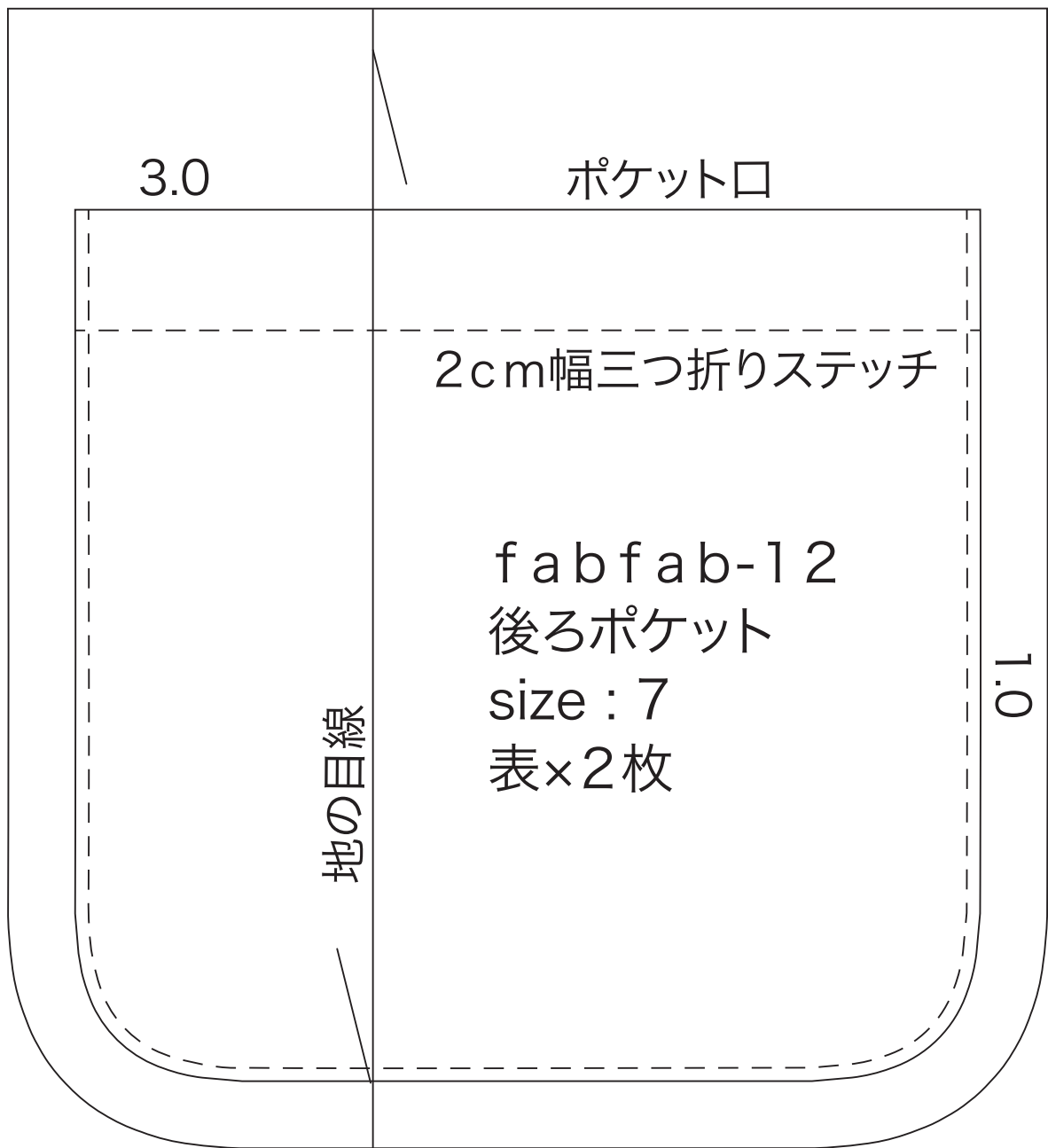

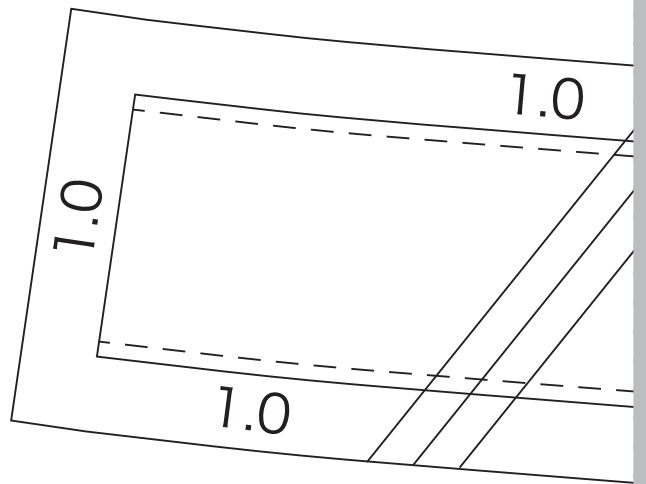
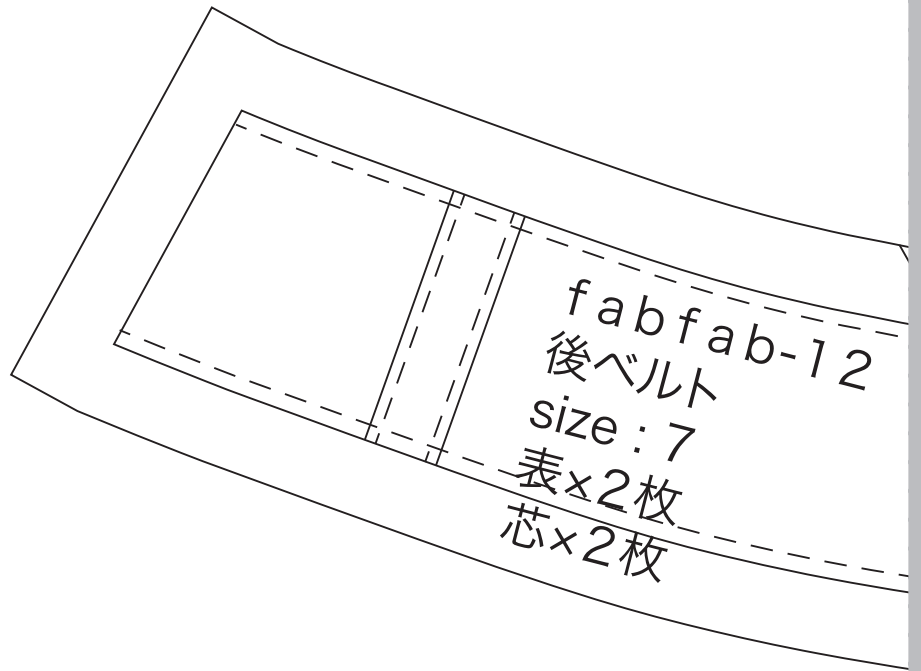

23

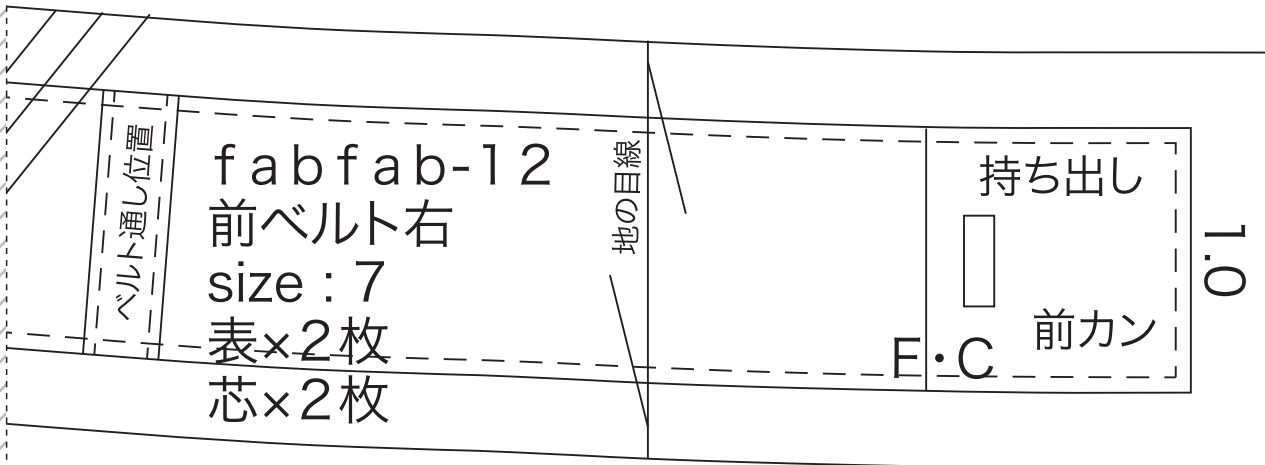
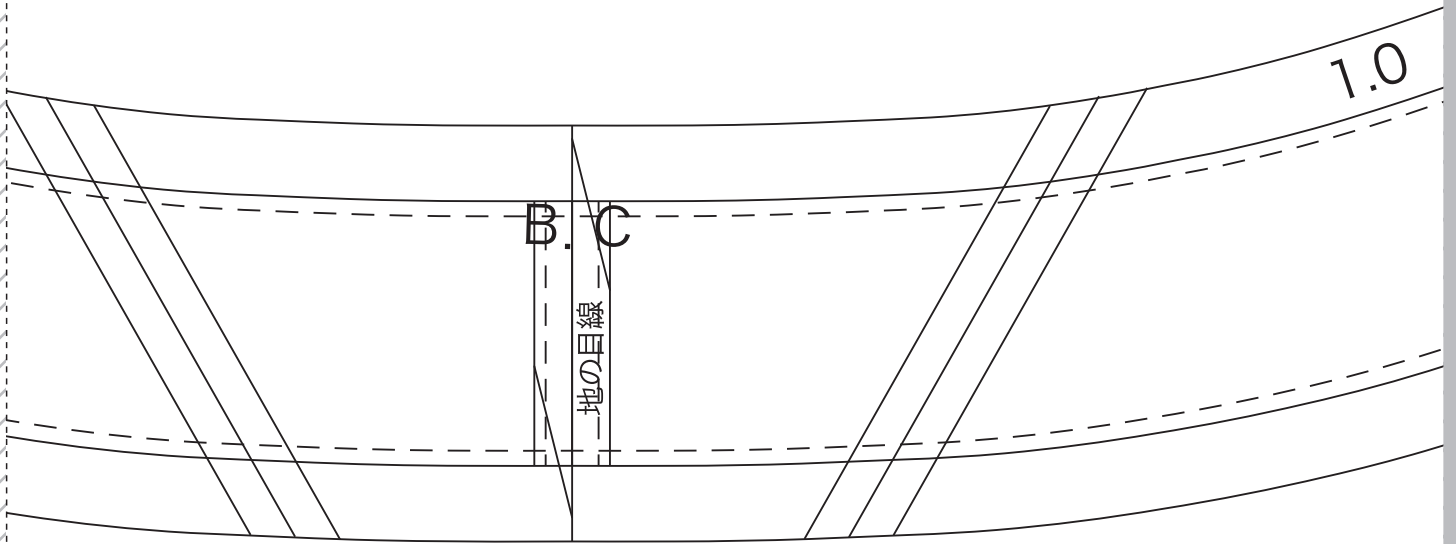

24

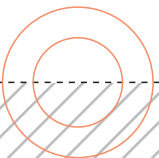
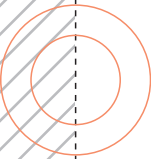
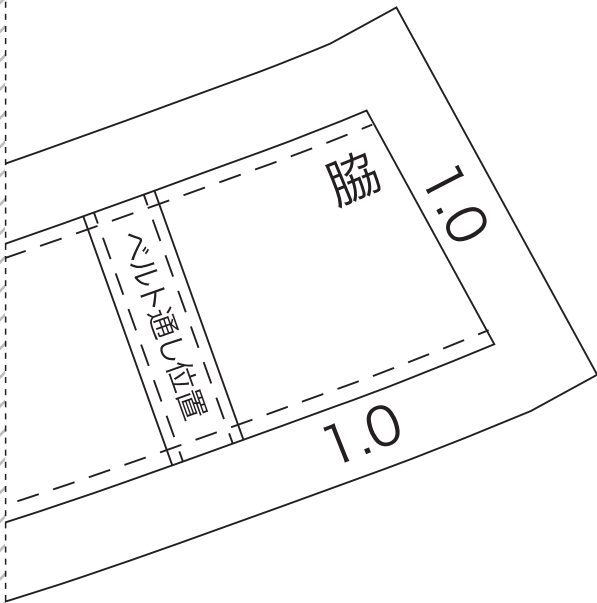

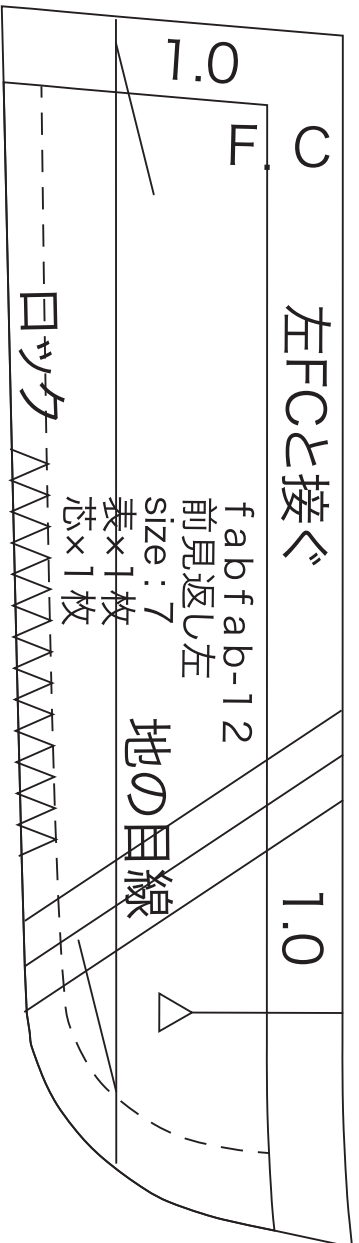
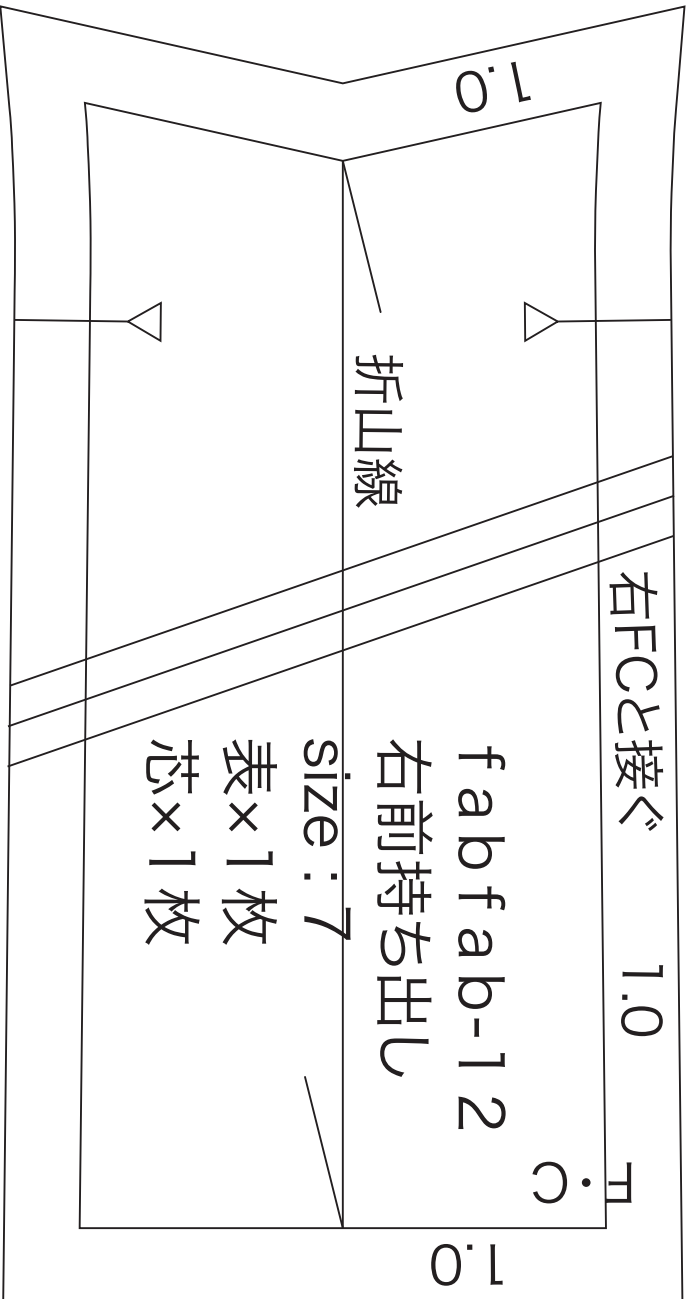

26

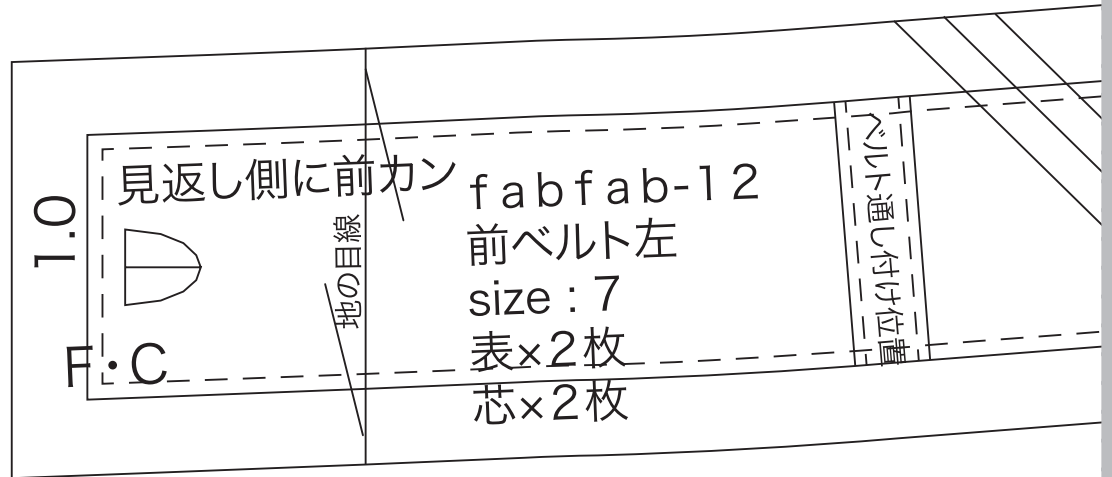

				fabfab-12			
				ベルト通し			
				size : 7			
				表×1枚			

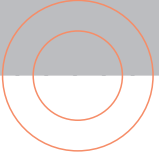

27

