

introduction はじめに

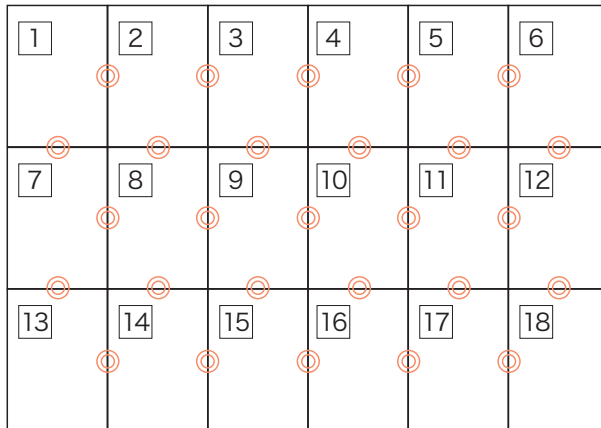

パターンは A4 サイズ 18 枚に分割されています。
印刷後、右図のようにつなぎ合わせてください。

! 印刷時の注意

印刷設定では、「ページの拡大や縮小」を選択せず
必ず、「実際のサイズ」(原寸) で印刷してください。



how to make パターンのつくりかた

STEP1 斜線部分  は切り取り、灰色部分  は残してのりしろにします。
(斜線と灰色を間違えないように注意)

STEP2 各用紙の番号を確認し、 の位置を合わせて、のりづけします。
(水のりは用紙が波打ちます。スティック糊などをお使いください)

STEP3 それぞれのパーツをハサミで切り出します。

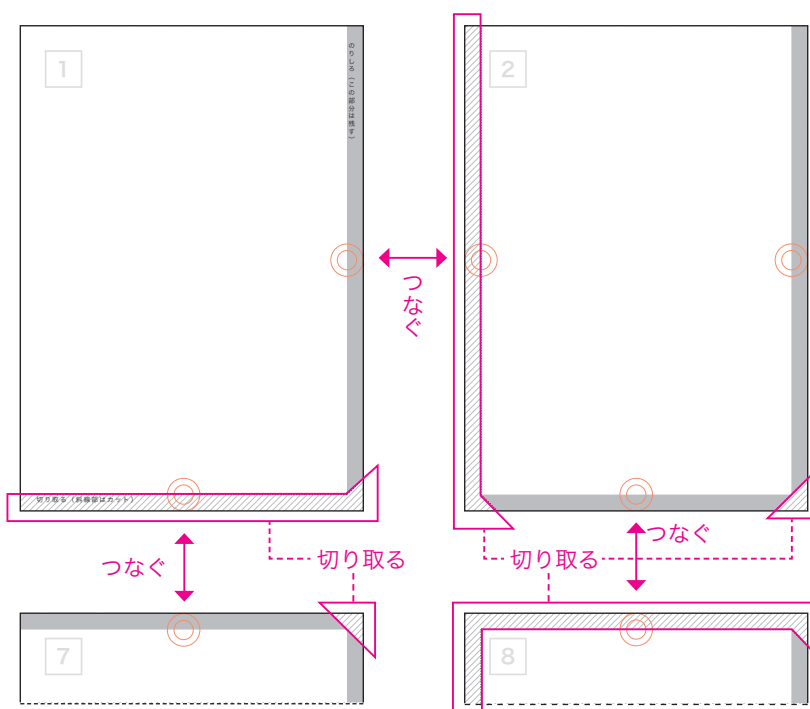

1

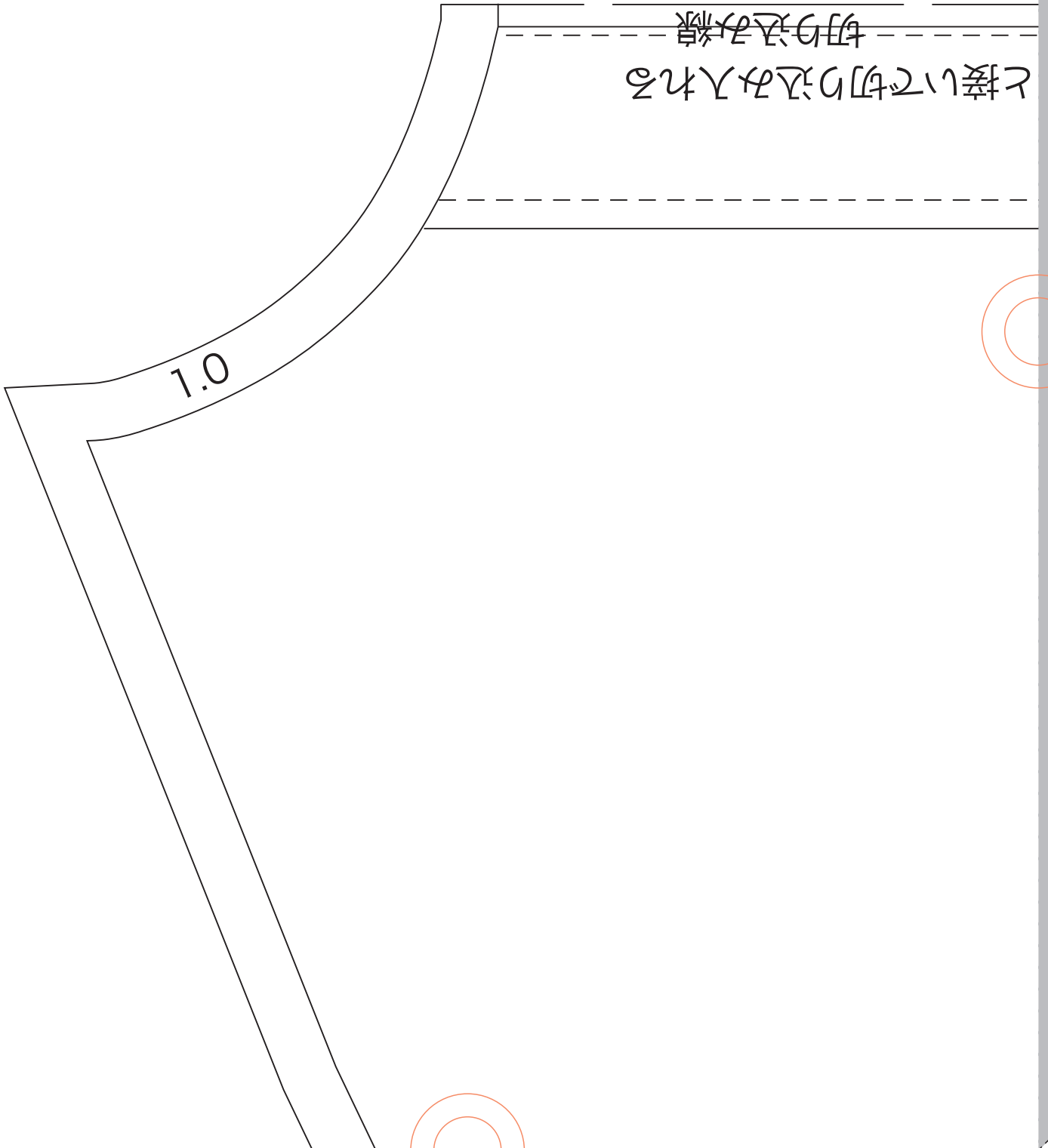

切り取る（斜線部はカット）

2

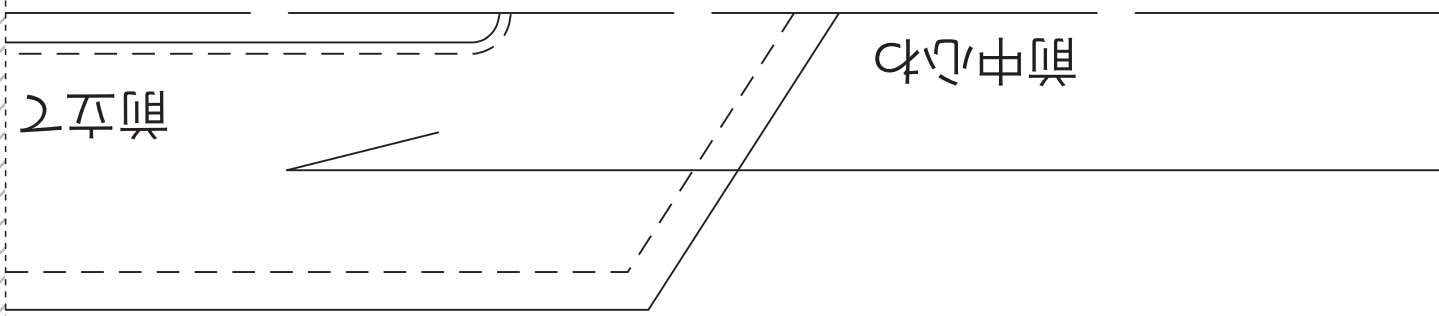

fabfab-3

前身頃

size : 9

表×1枚

3

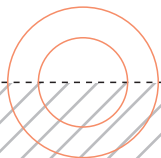
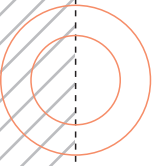

4

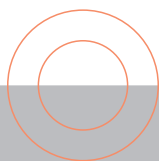
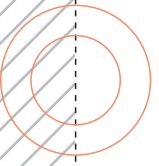

5

3つ折りにして 3cm ステッチ

裾線

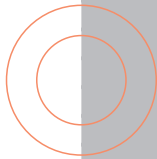
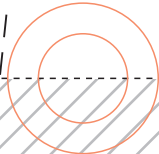
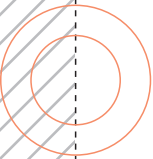

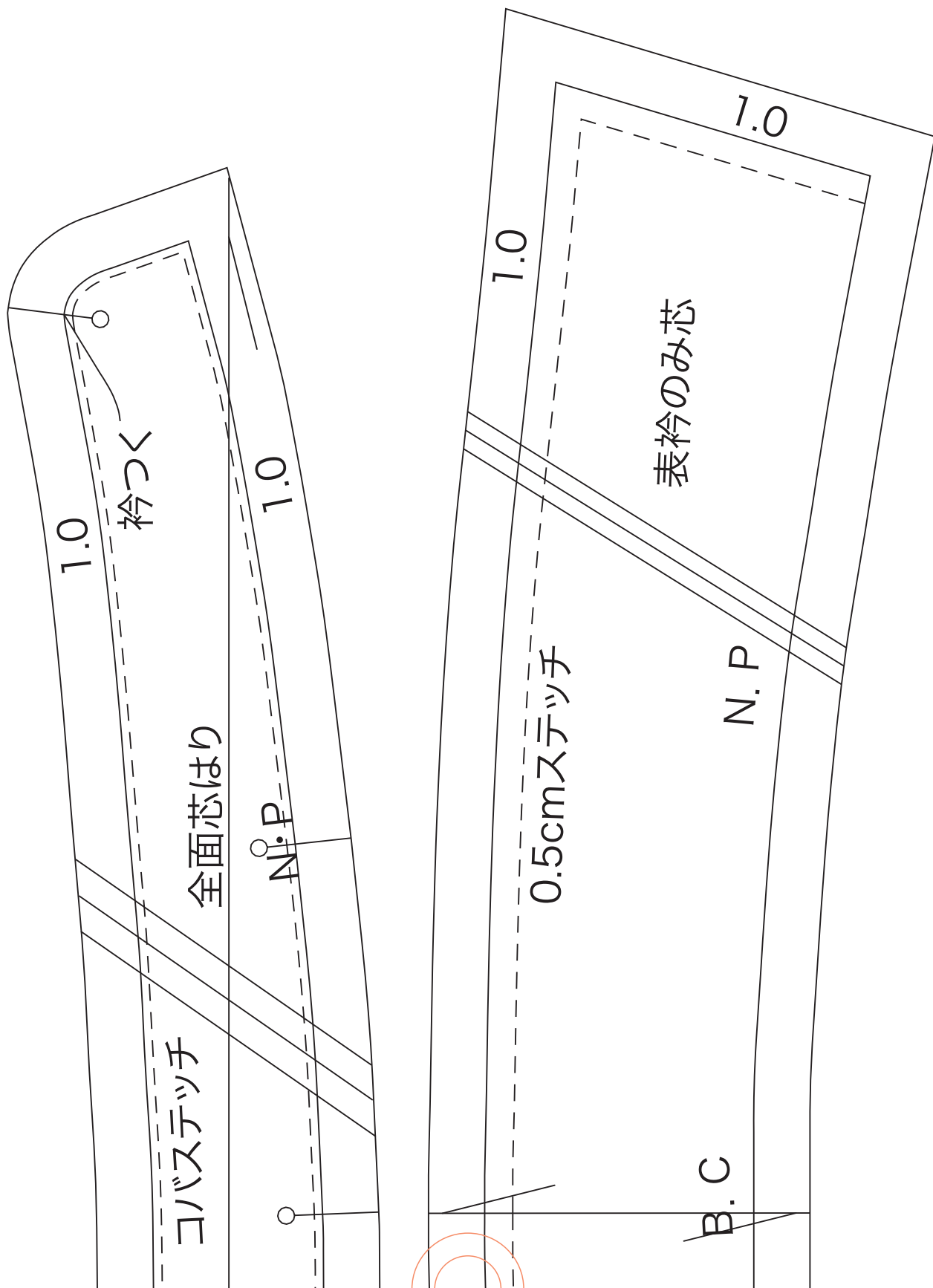

7

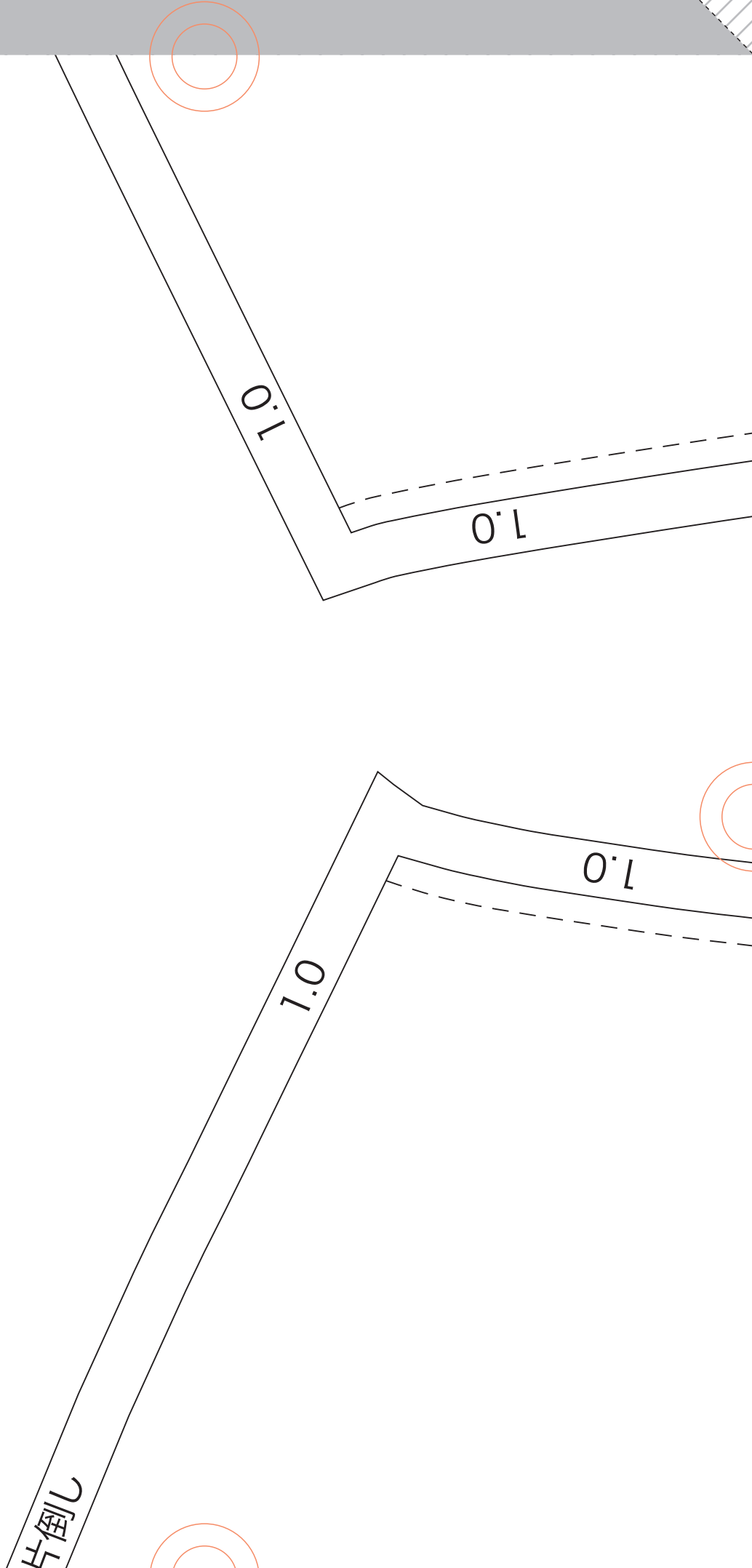

8

0.5cmステッチ

三ツ巻き始末

三ツ巻き始末

0.5cmステッチ

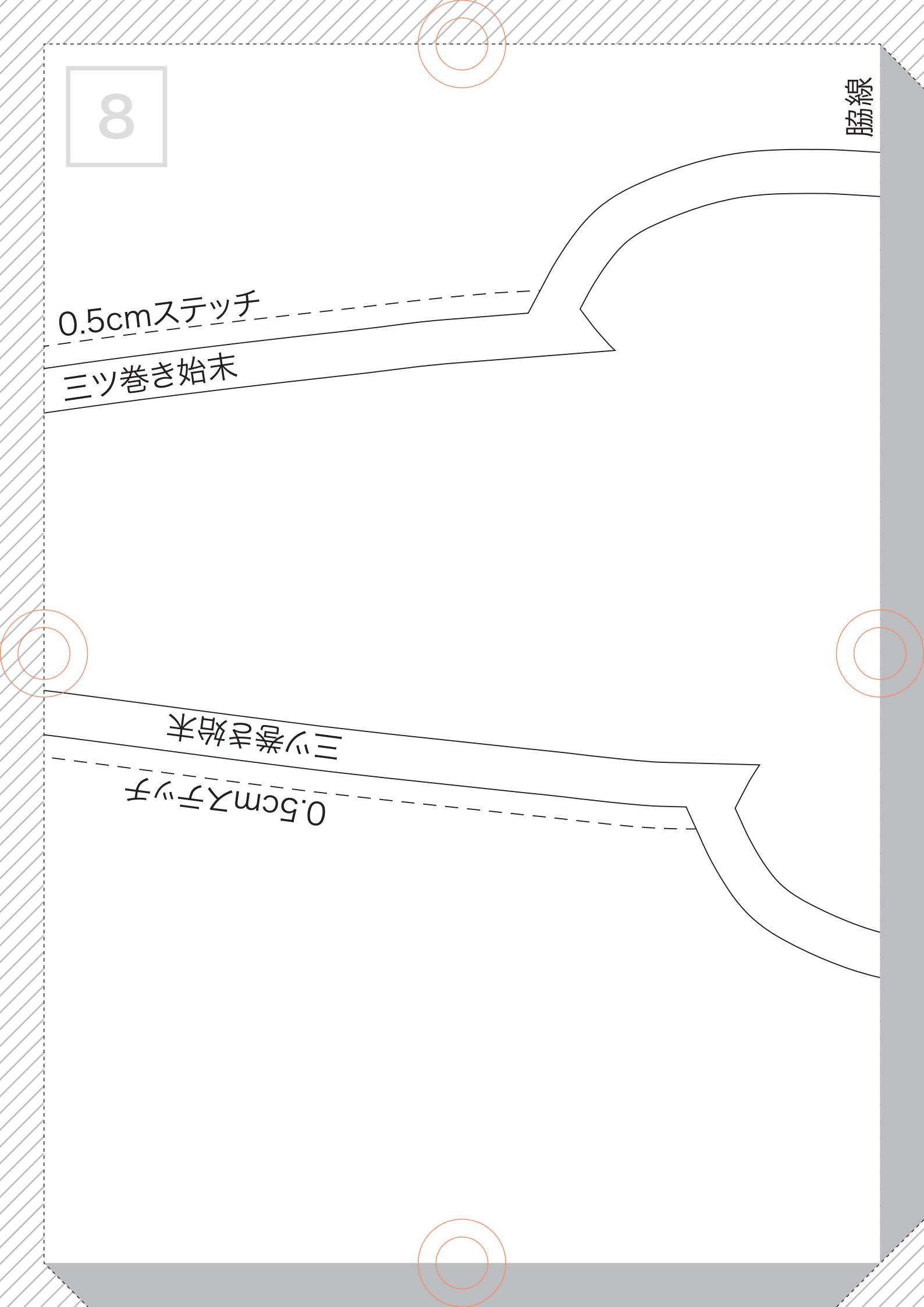

9

0.1

1.0

脇線

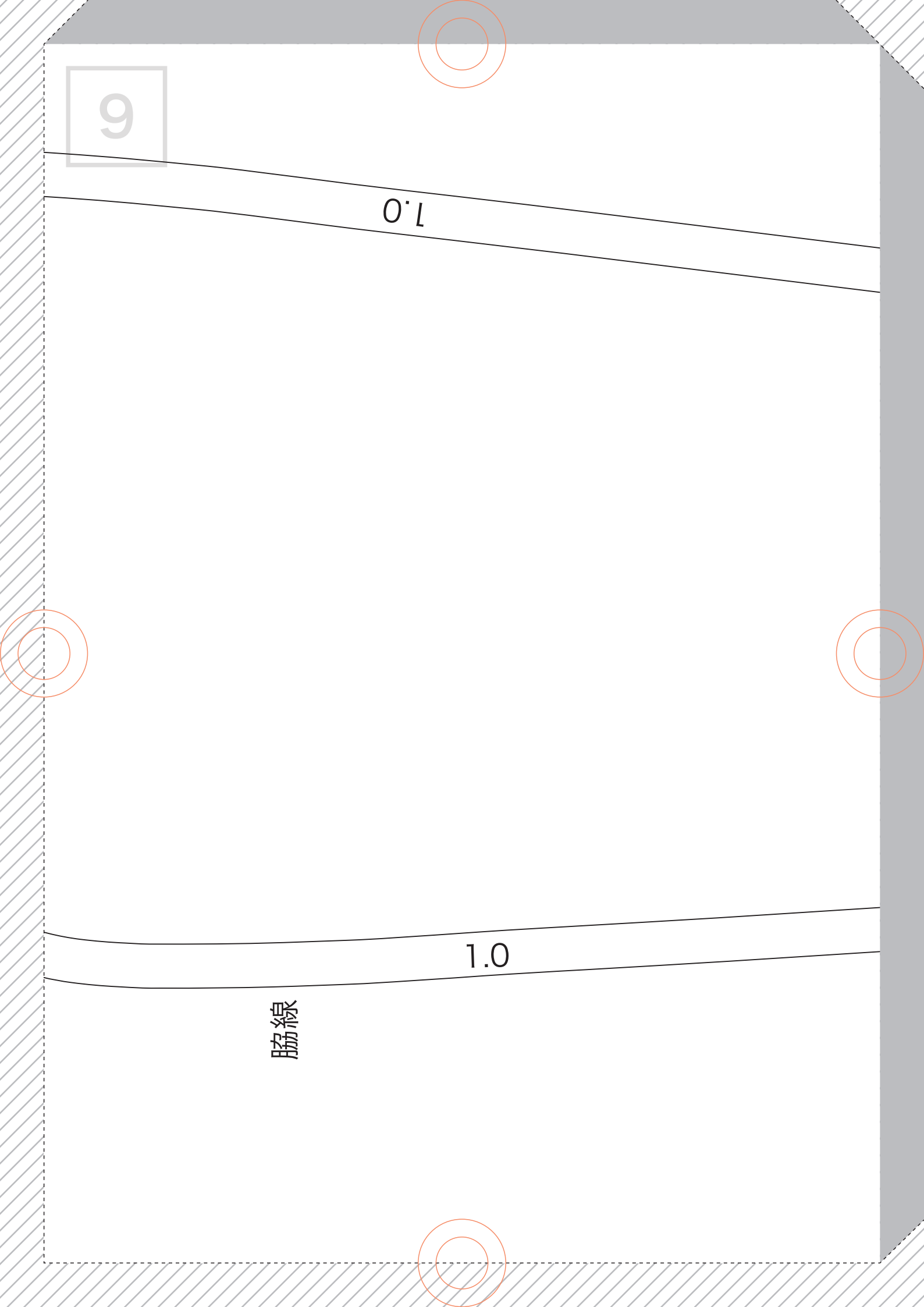

10

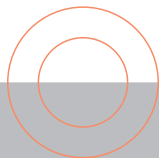
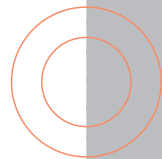
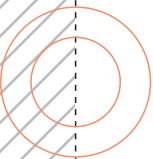
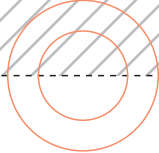

11

4.0

4.0

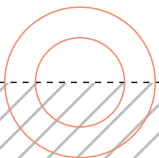
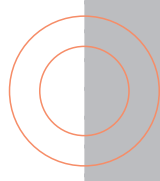
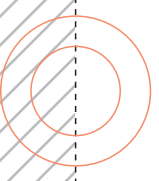
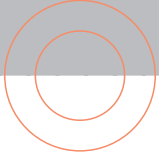

12

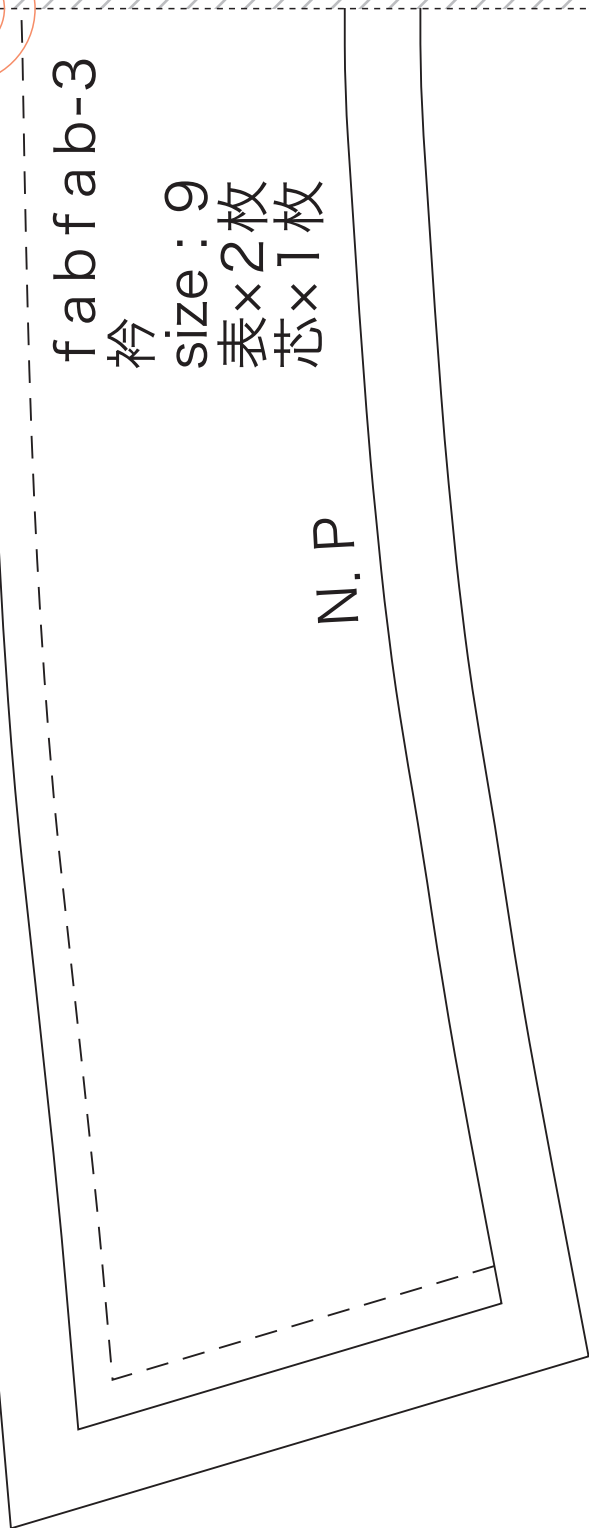
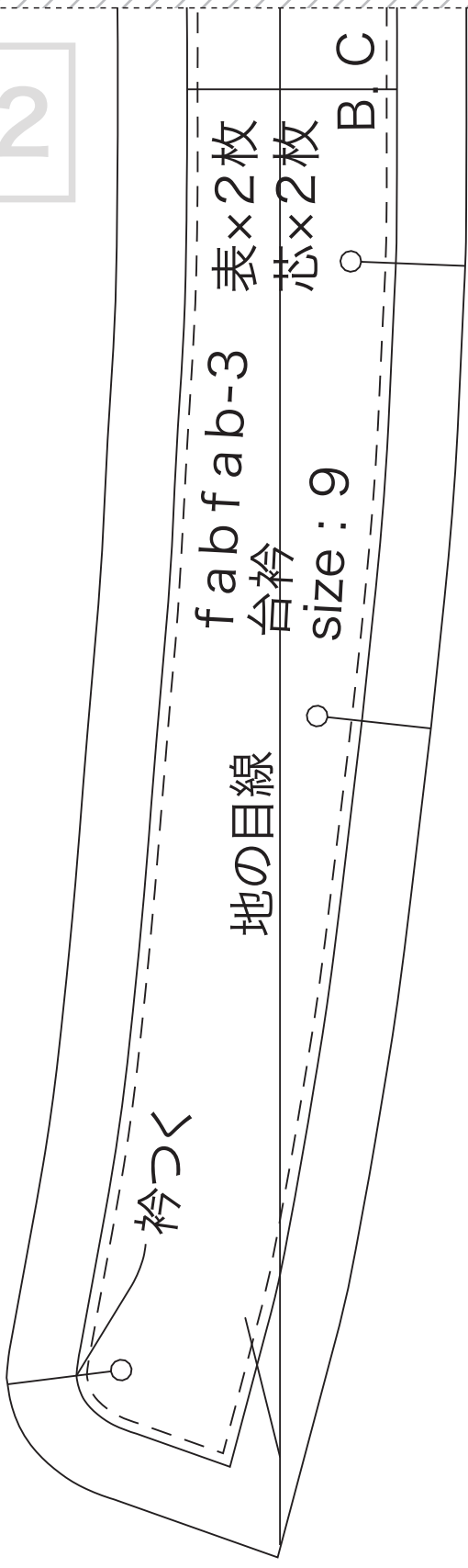

13

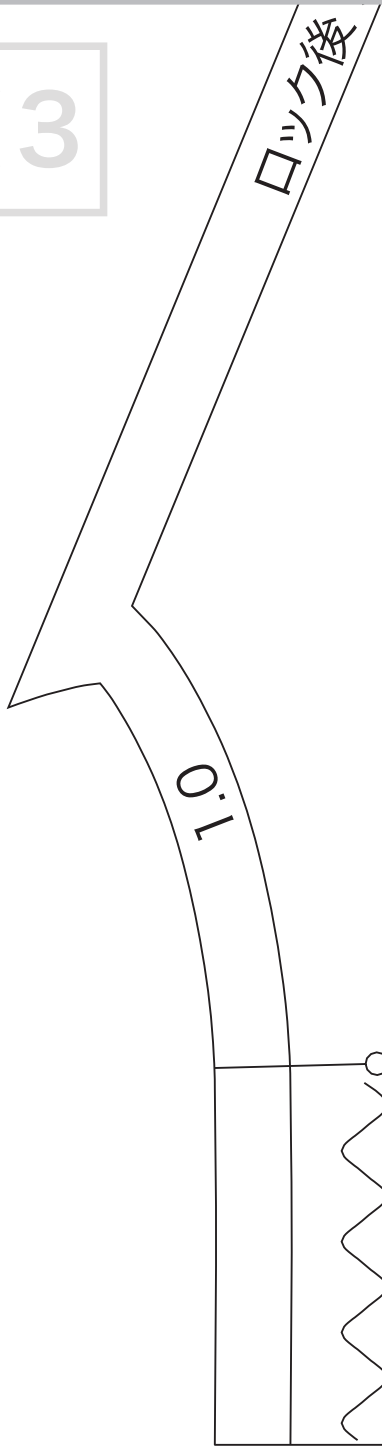

ギャザー 上がり5cm

後ろ中心わ

14

f a b f a b - 3

後身頃

size : 9

表×1枚

15

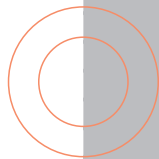
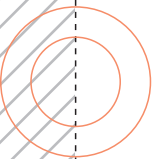
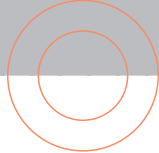

16

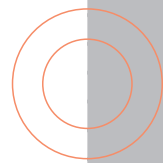
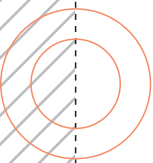
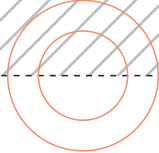

17

3つ折りにして3cmステッチ

裾線

