

introduction はじめに

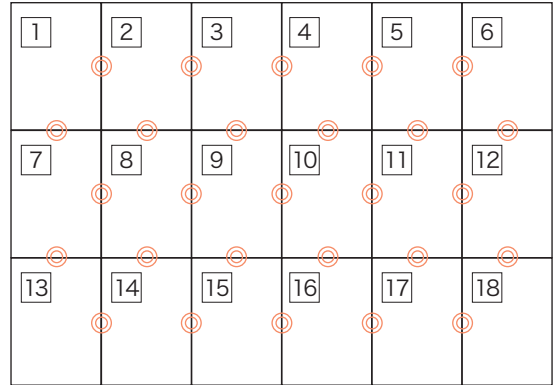

パターンは A4 サイズ 36 枚に分割されています。
印刷後、右図のようにつなぎ合わせてください。

! 印刷時の注意

印刷設定では、「ページの拡大や縮小」を選択せず
必ず、「実際のサイズ」(原寸) で印刷してください。



how to make パターンのつくりかた

STEP1 斜線部分  は切り取り、灰色部分  は残してのりしろにします。
(斜線と灰色を間違えないように注意)

STEP2 各用紙の番号を確認し、 の位置を合わせて、のりつけします。
(水のりは用紙が波打ちます。スティック糊などをお使いください)

STEP3 それぞれのパーツをハサミで切り出します。

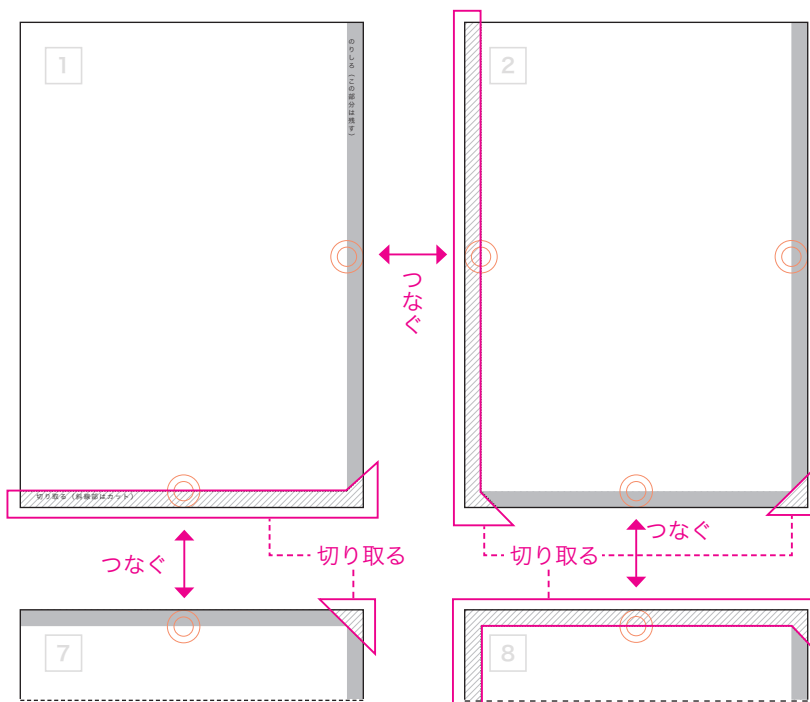
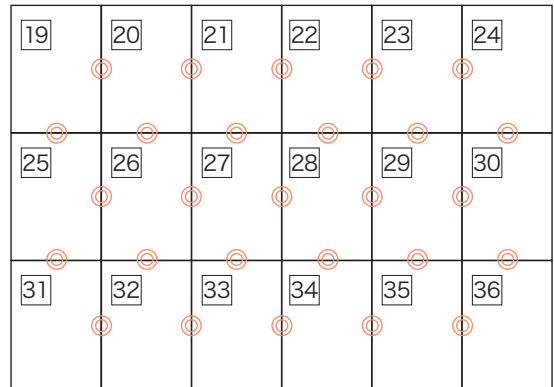

1



切り取る (斜線部はカット)

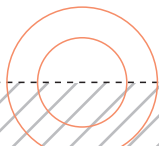

2

はぐ

タック

タック

タック

0.5cm巾ステッチ

共布
(釦)

切りぬく

中縫い

中縫い

中縫い

中縫い

縫いどまり

F. C

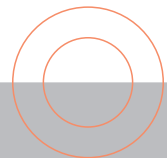
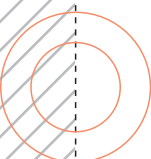

3

1.0

ループ
=12mm)

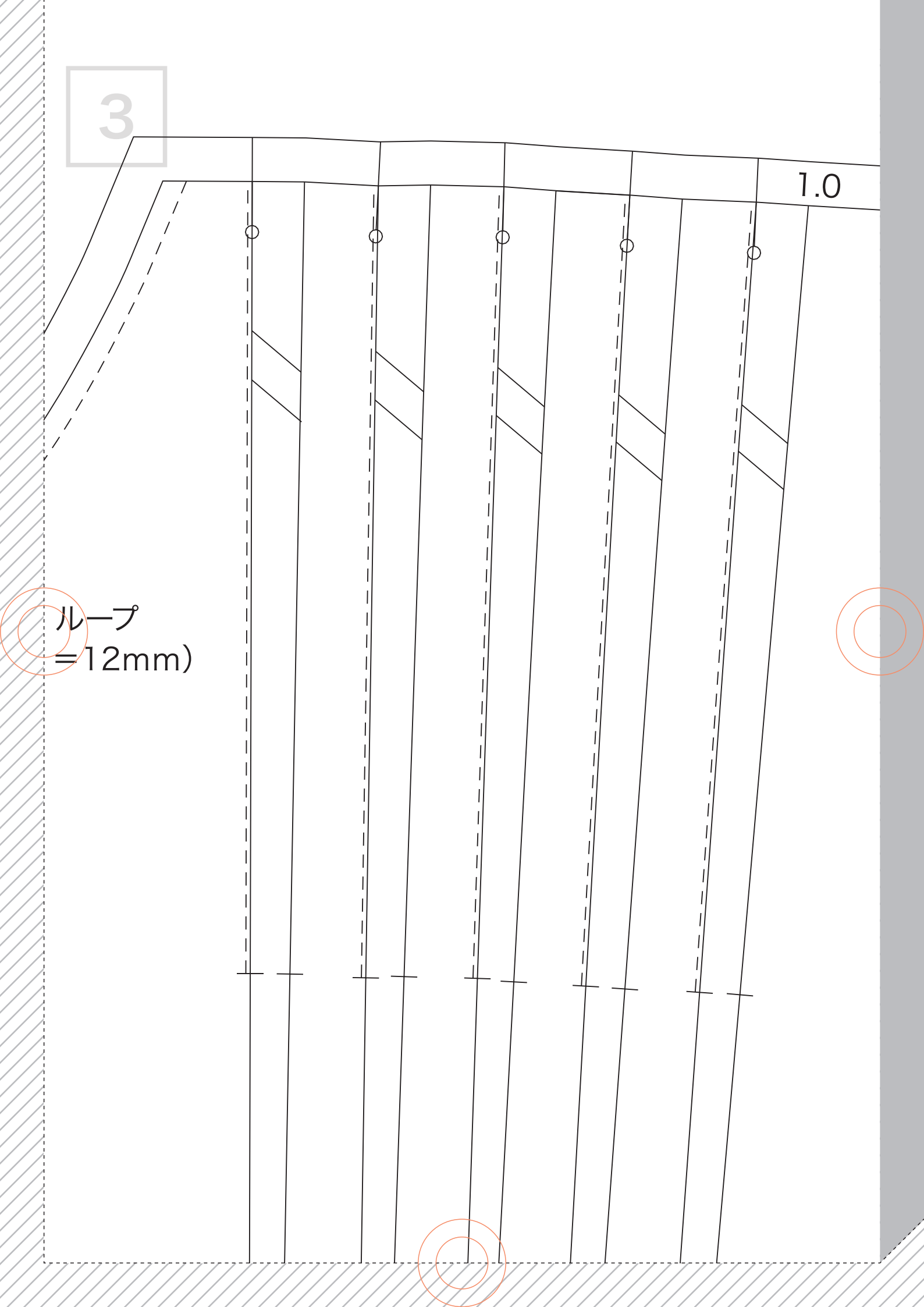

4

1.0

1.0

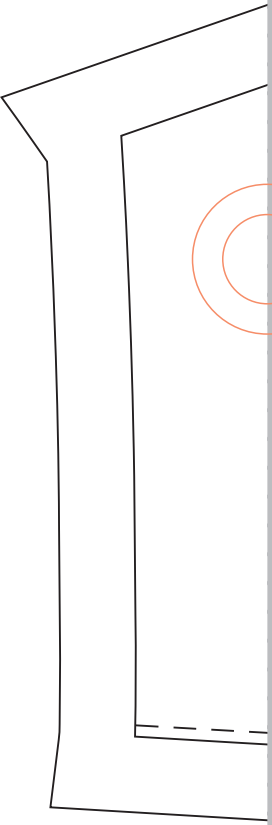
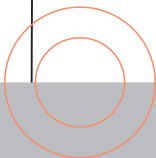
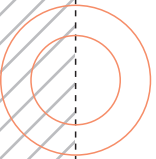

5

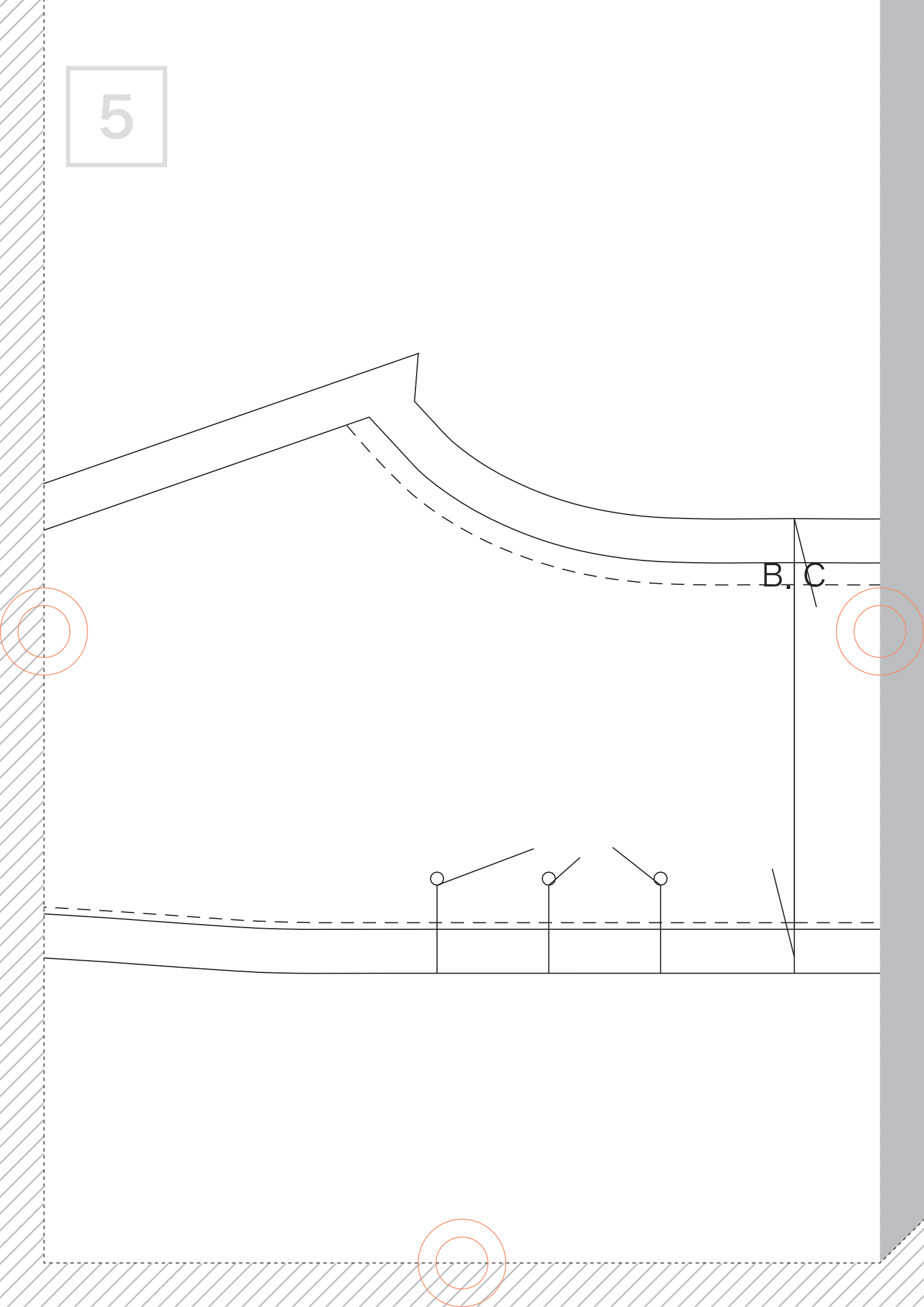

6

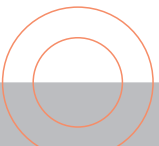
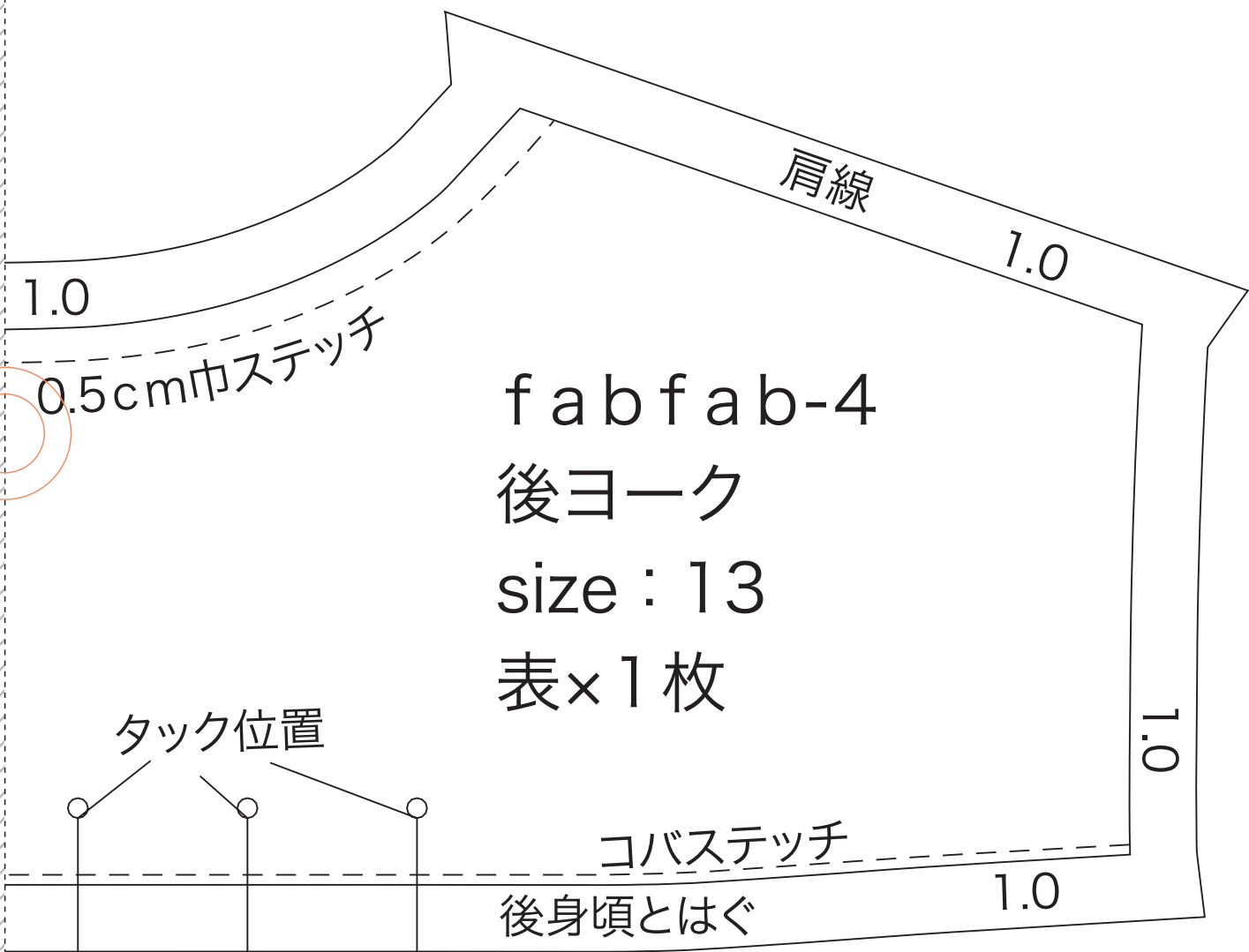

7

糸ループ 付く

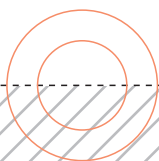
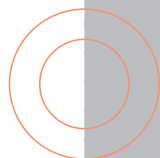
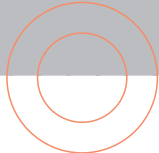

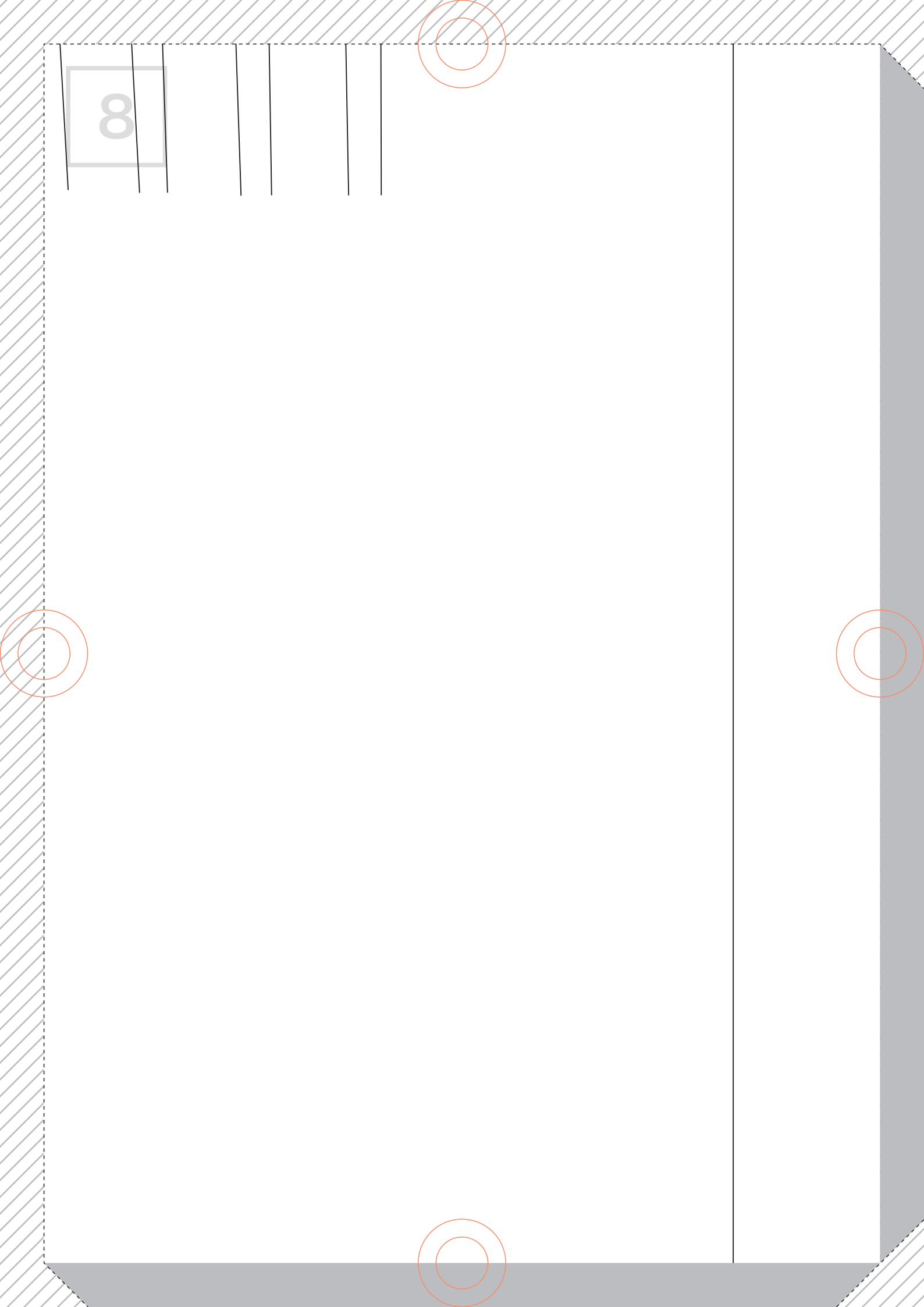

8

9

f a b f a b-4

前身頃

size : 13

表×1枚

10

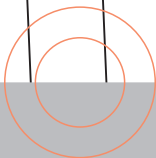
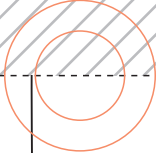
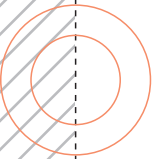

11

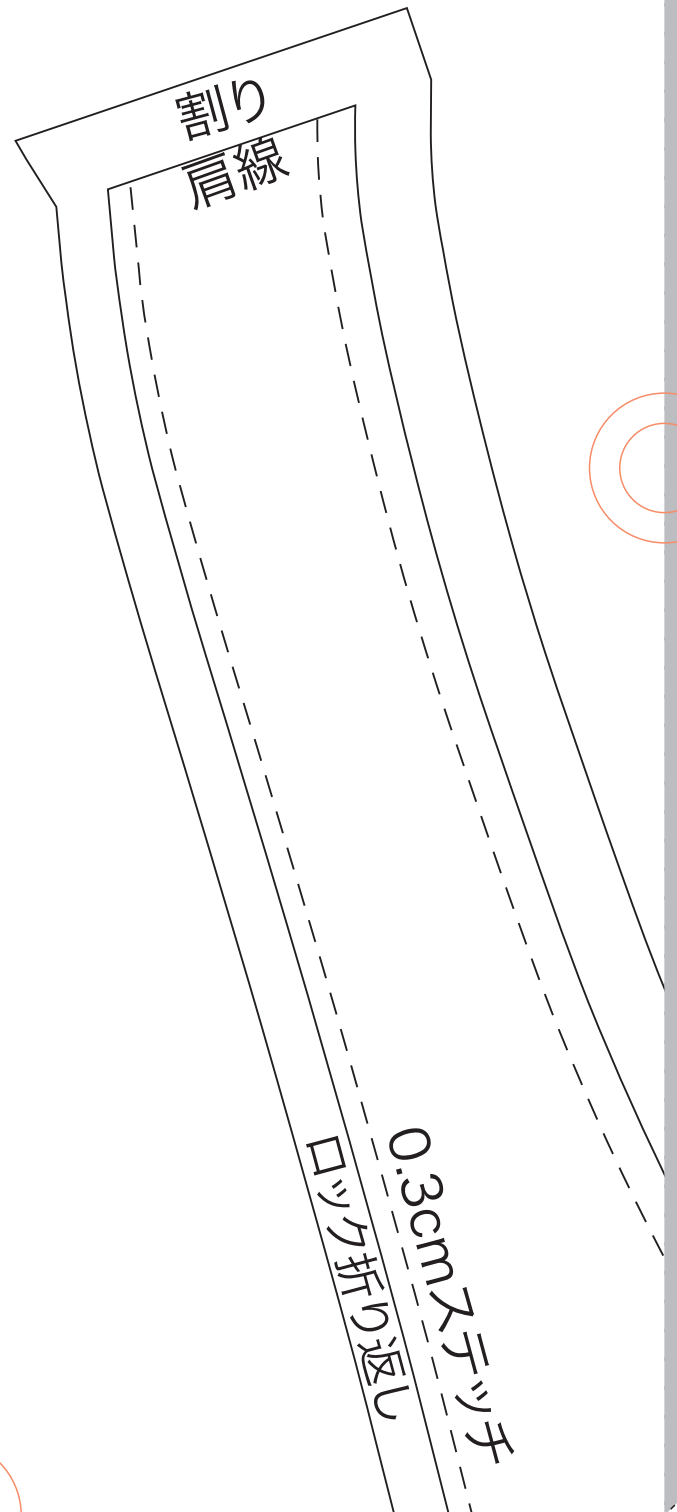

12

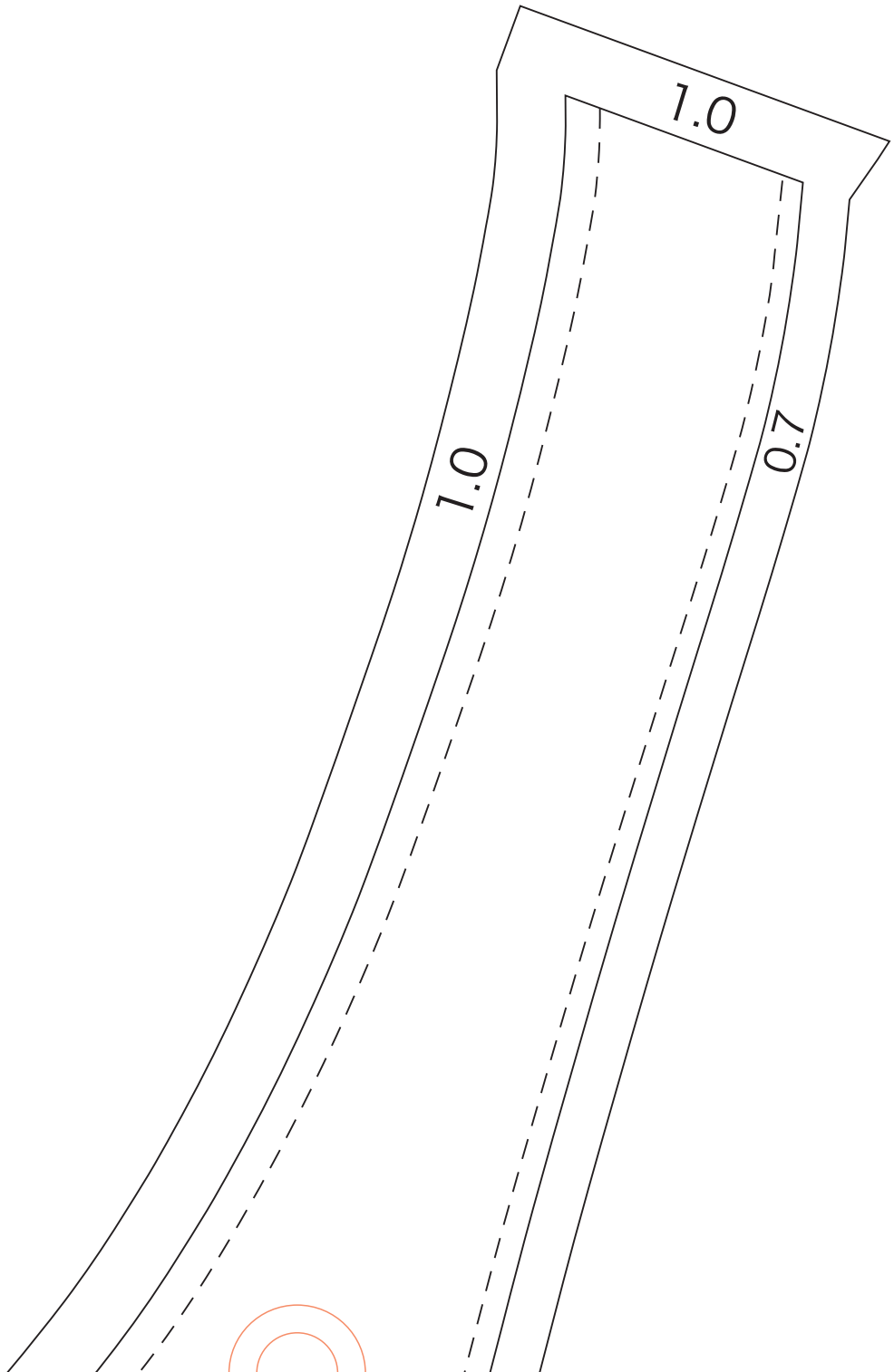
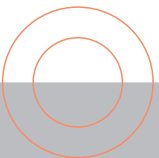
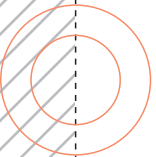
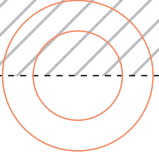

13

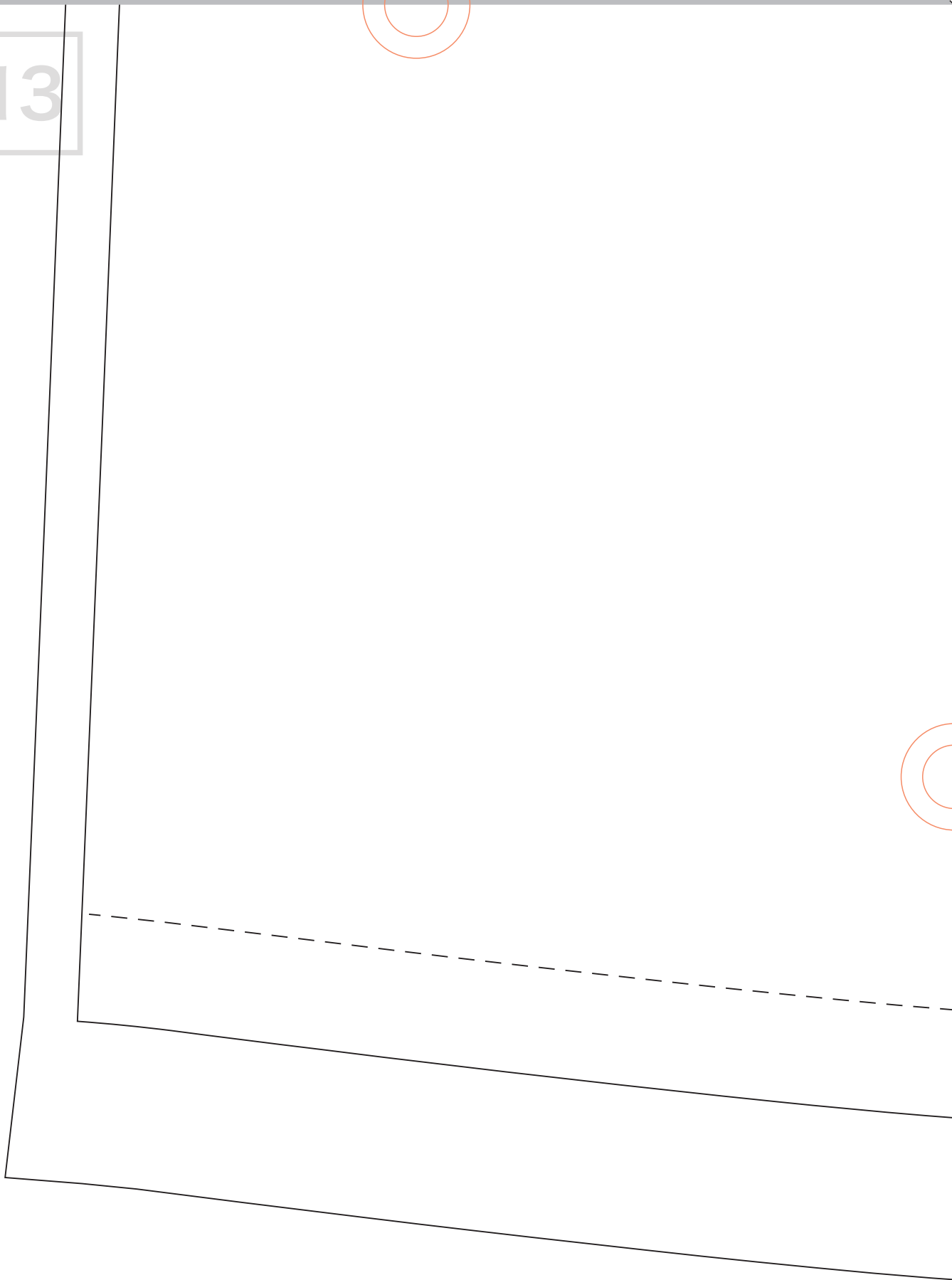
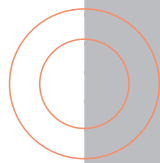

14

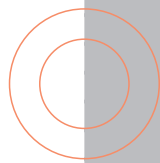
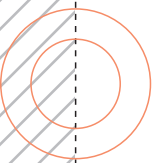
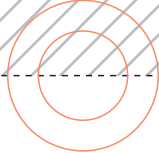

3つ折りして2cm幅ステッチ

裾出来上がり線

15

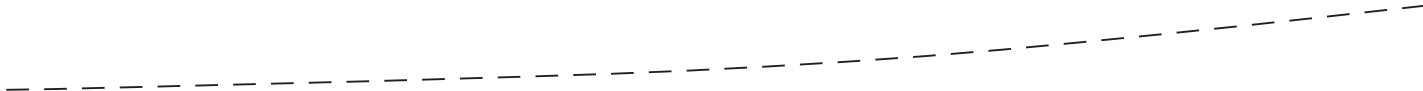
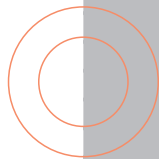
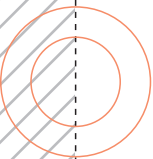
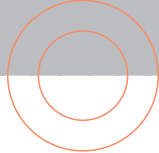

3.0



16

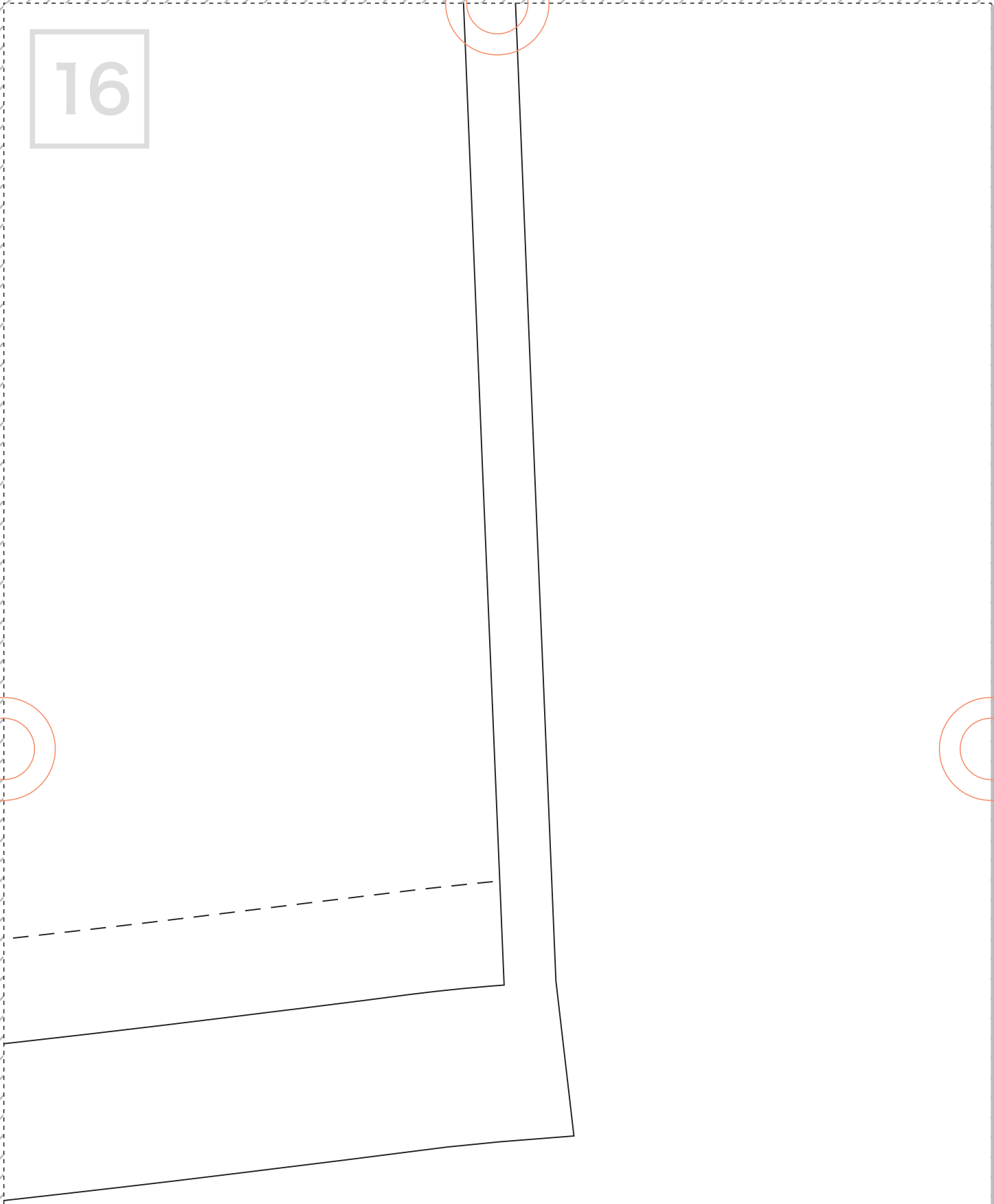
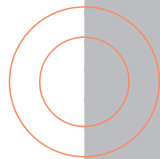
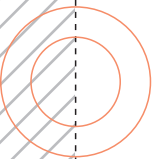
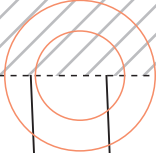

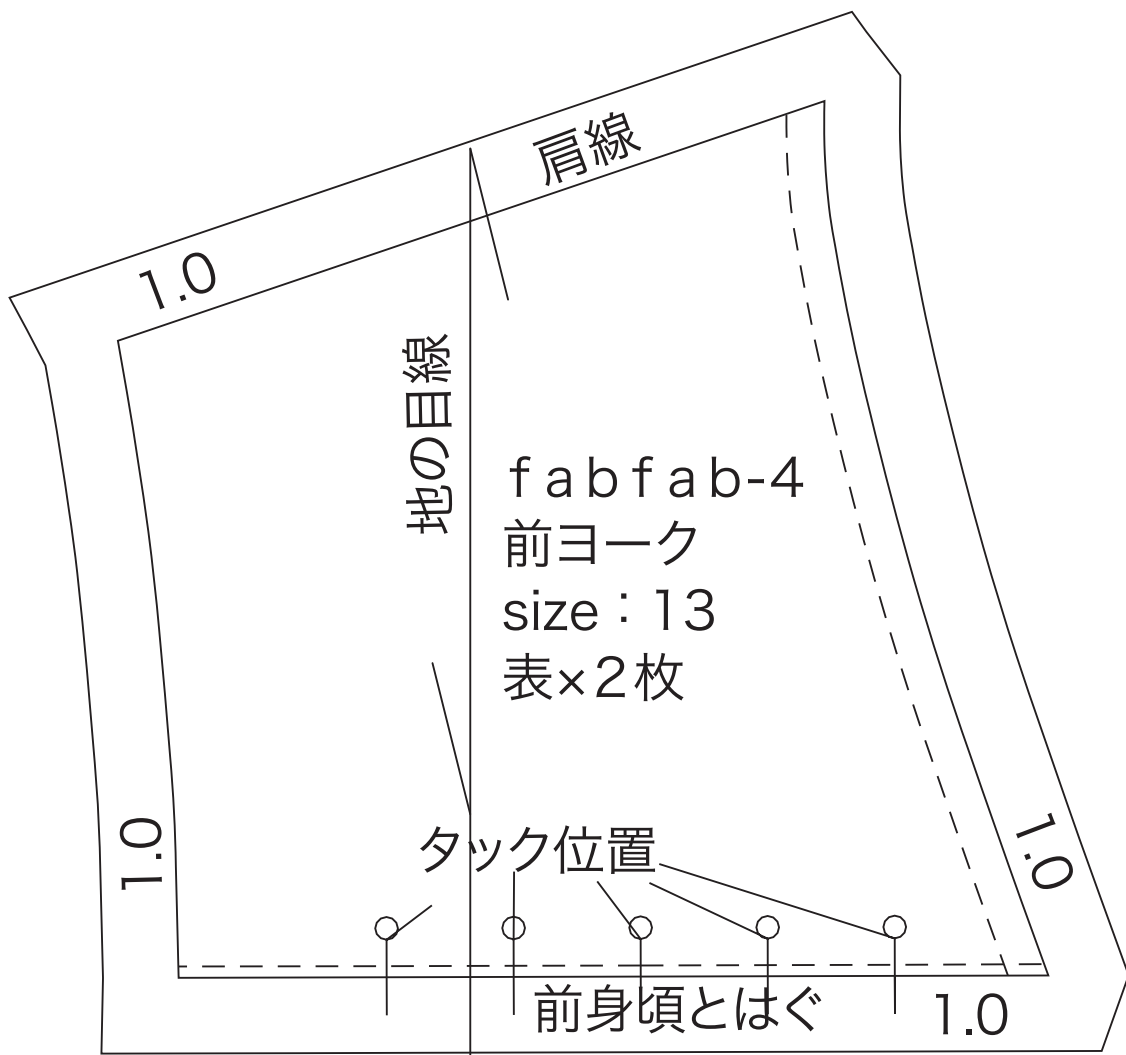

18

f a b f a b-4
前衿ぐり見返し
size : 13
表×1枚
芯×1枚

F.C

切りぬく

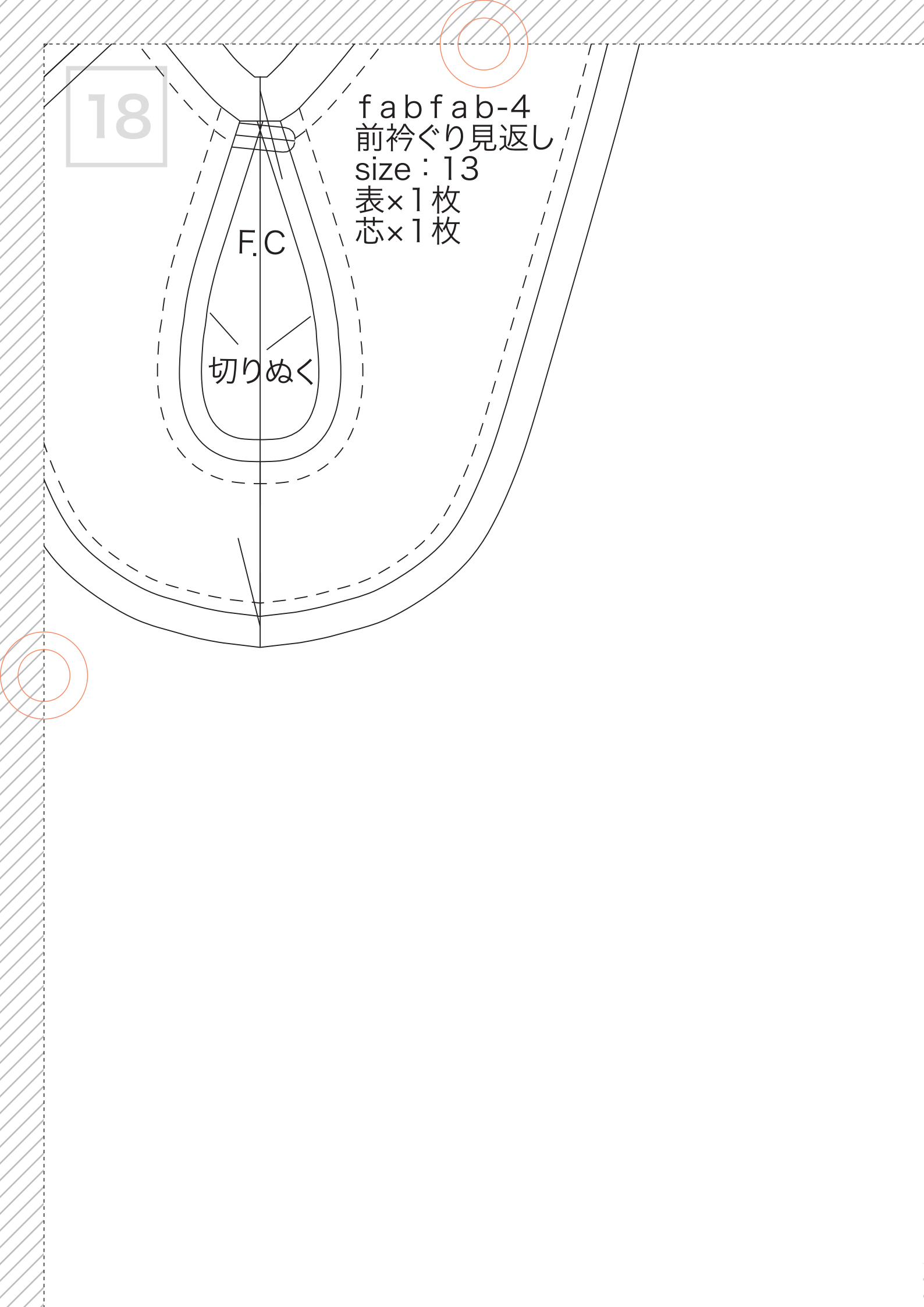

19

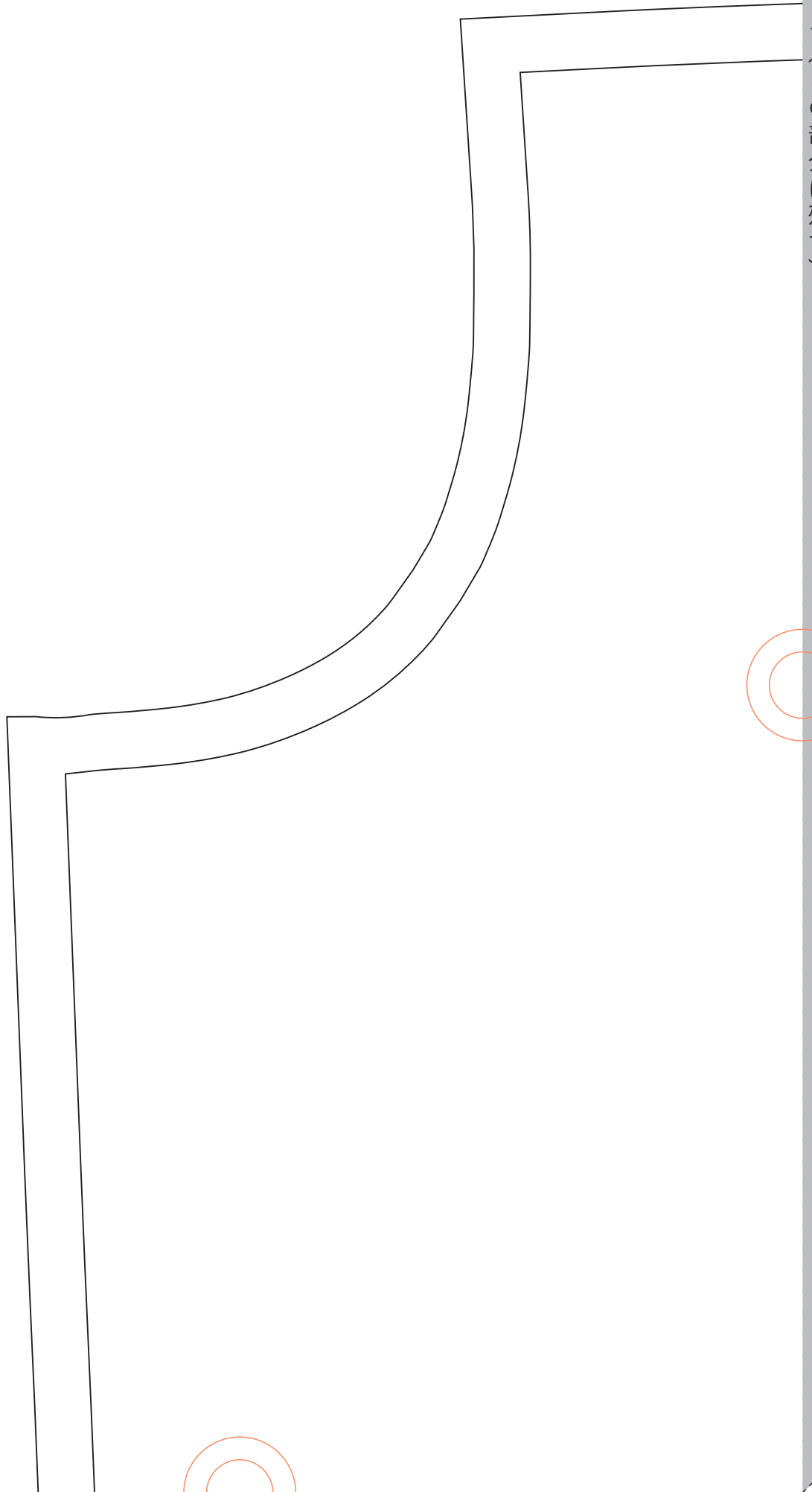

切り取る (斜線部はカット)

20

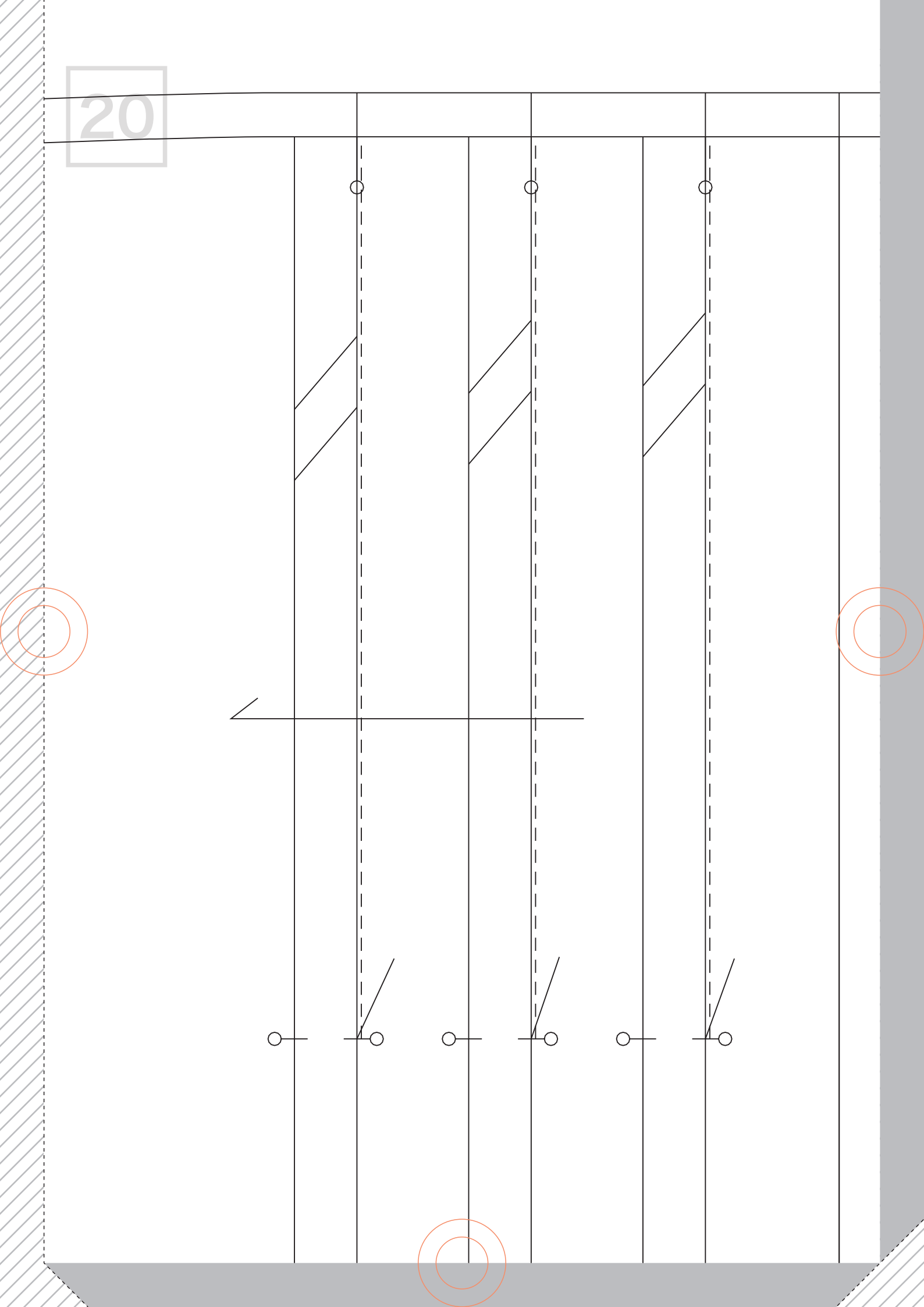

タック

タック

タック

タック倒し方向

中縫い

中縫い

中縫い

縫いどまり

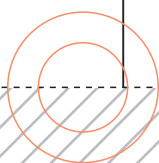
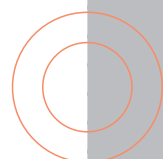
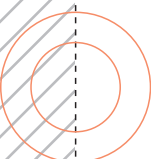

22

1.0

1.0

脇線

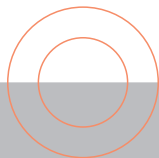
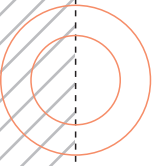

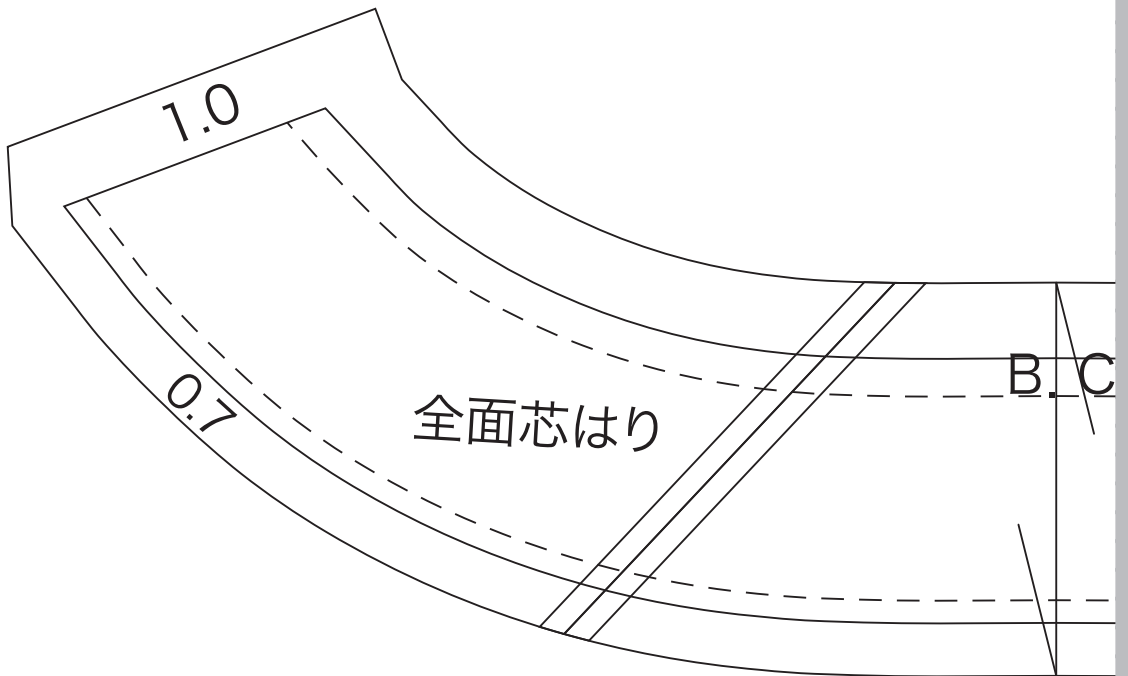
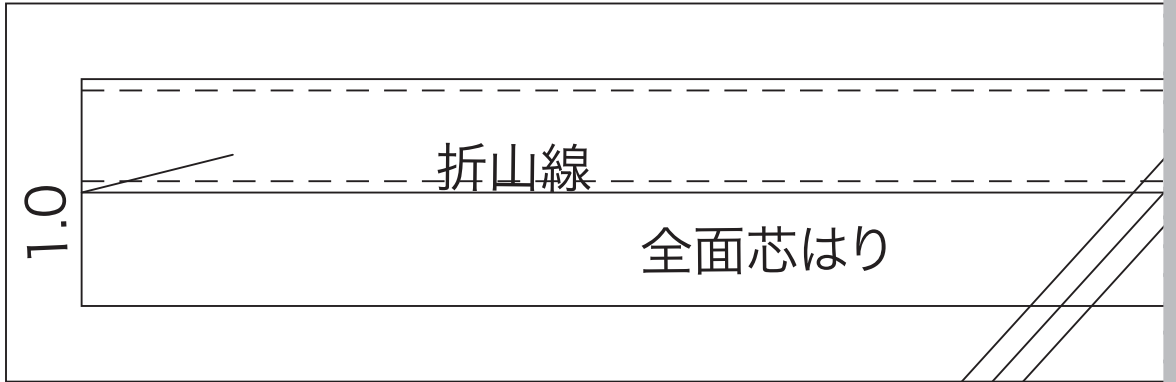

24

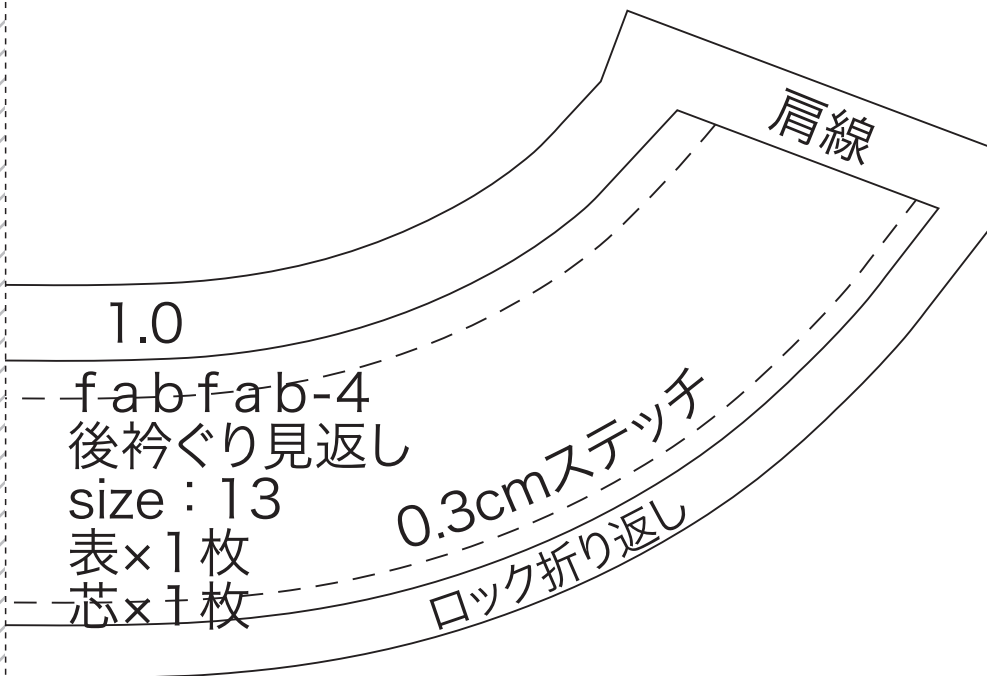
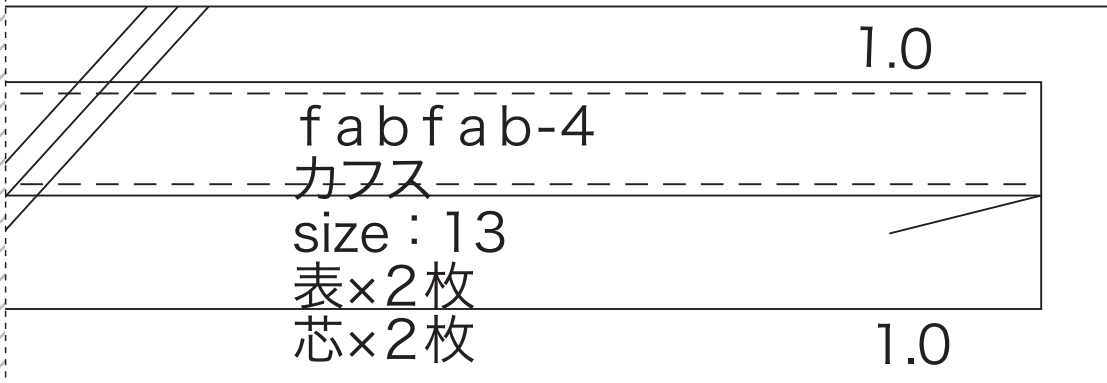

25

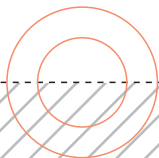
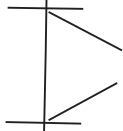
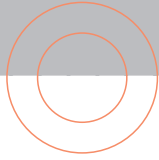

26

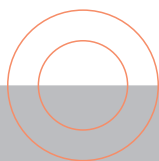
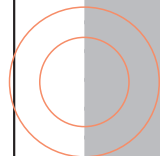
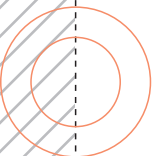
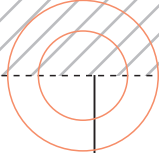

27

f a b f a b - 4

後身頃

size : 13

表×1枚

28

糸ループ 付く

袖下

後ろ

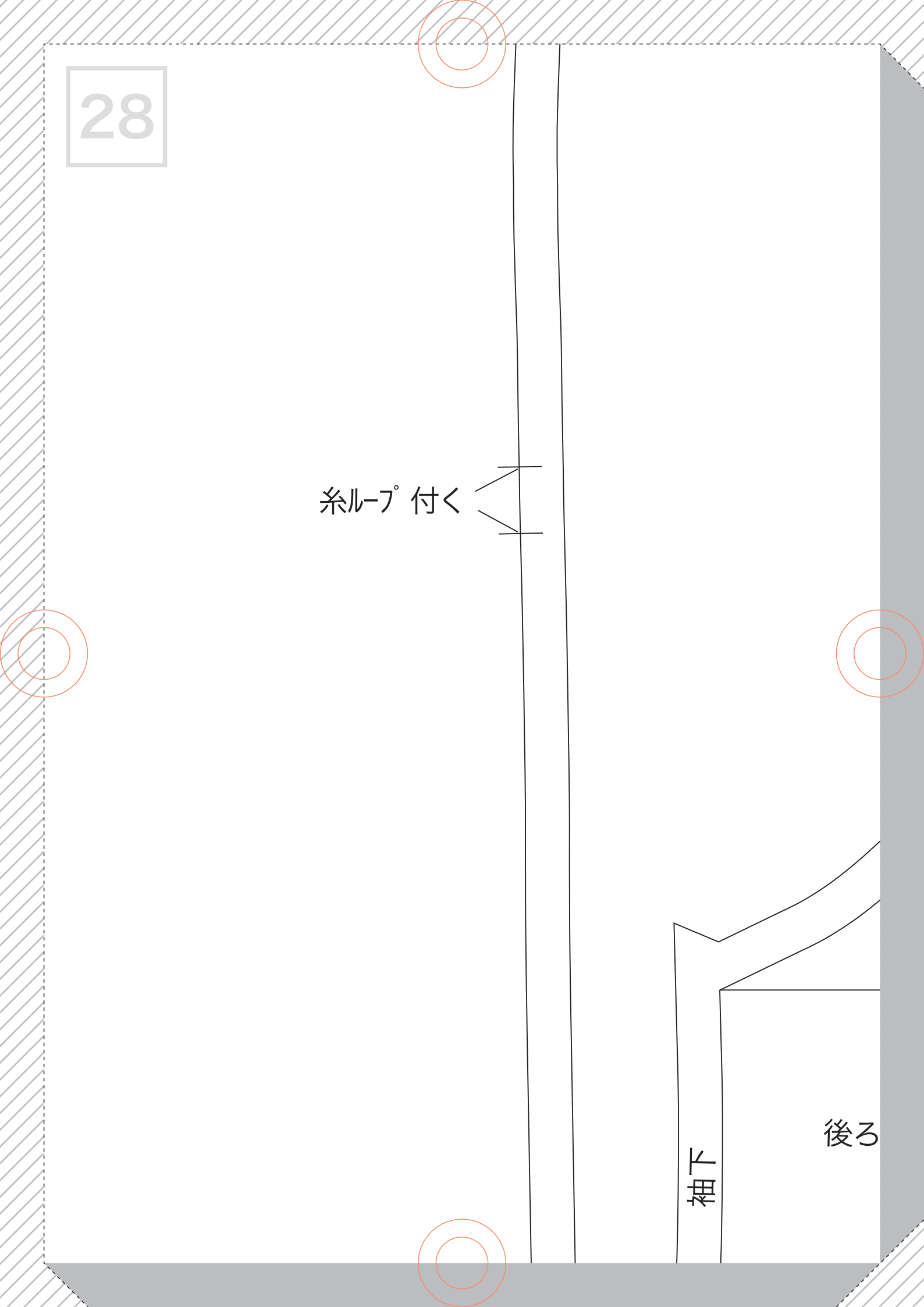

29

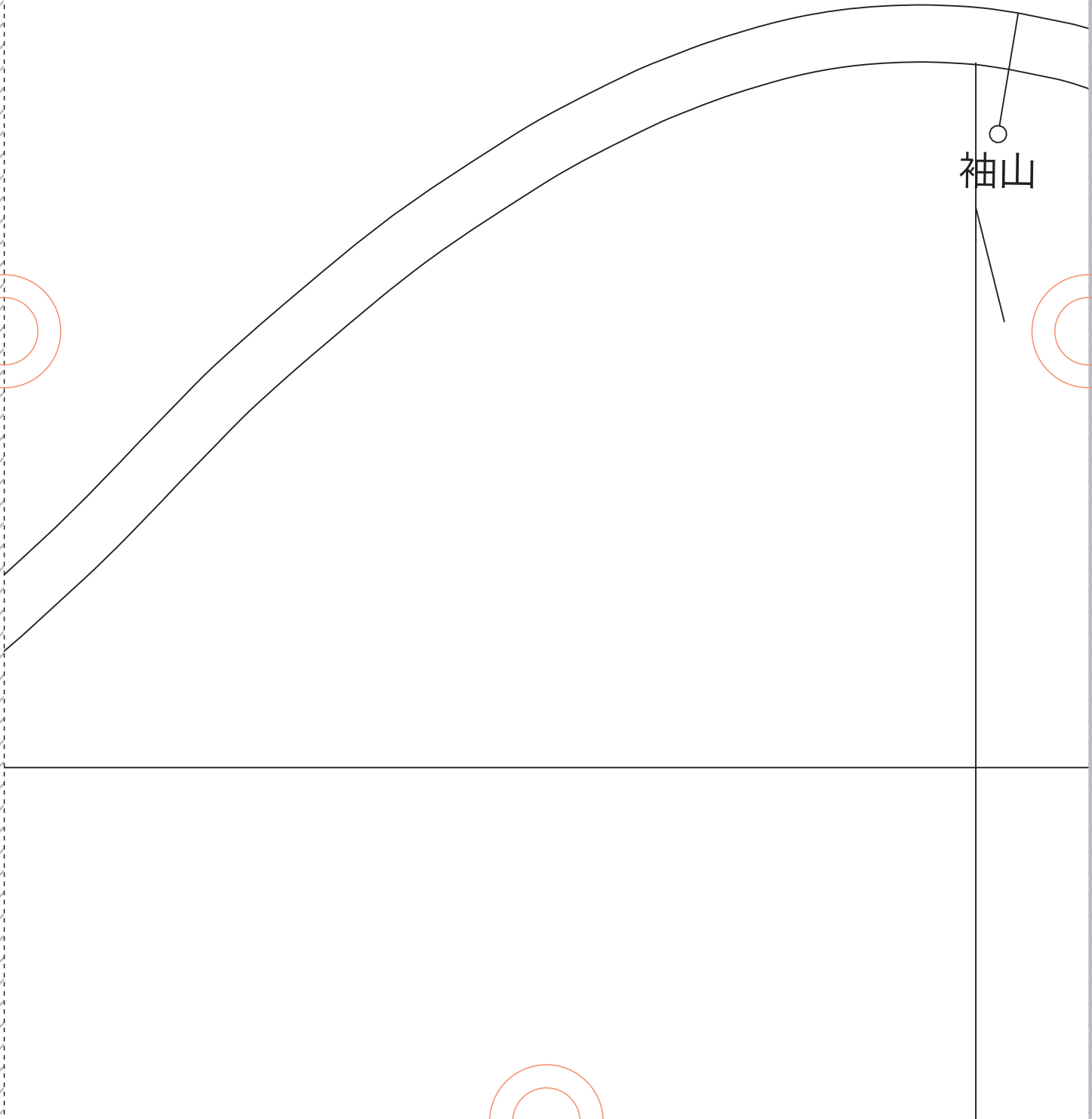

袖山

30

	fabfab-4
	ループ
---	size: 13
	表×1枚

1.0

前

番

31

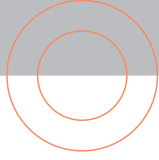

接

接

32

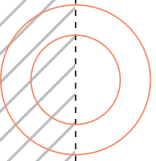
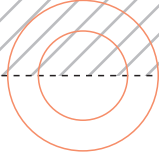

1.0

33

3つ折りして2cm幅ステッチ

裾出来上がり線

3.0

fabfab-4

リボン

size : 13

表×2枚

34

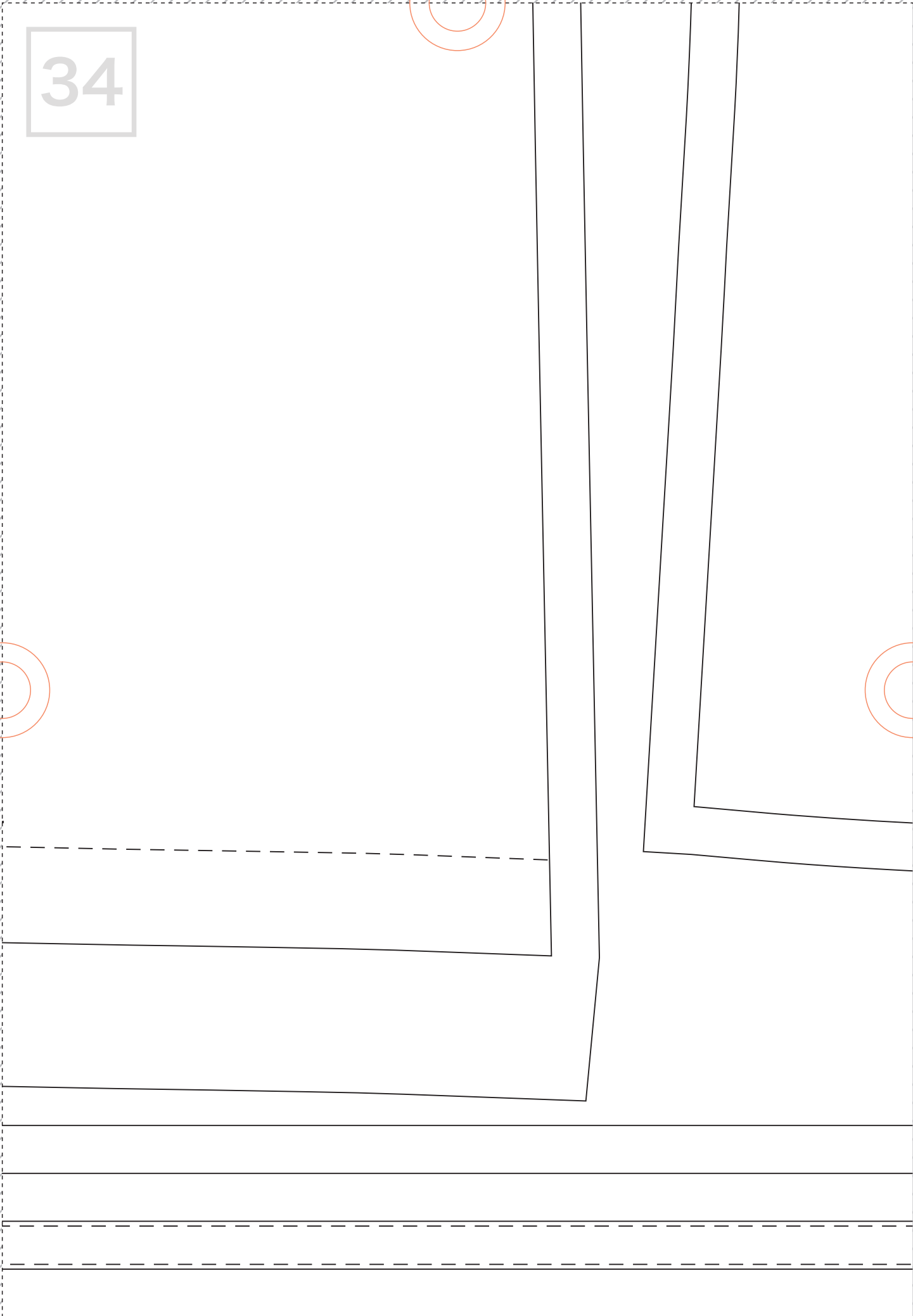
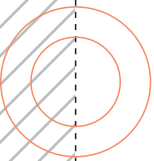
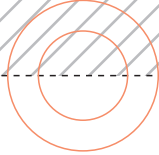

35

f a b f a b - 4

袖

size : 13

表×2枚

地の目線

ギャザー均等に寄せる

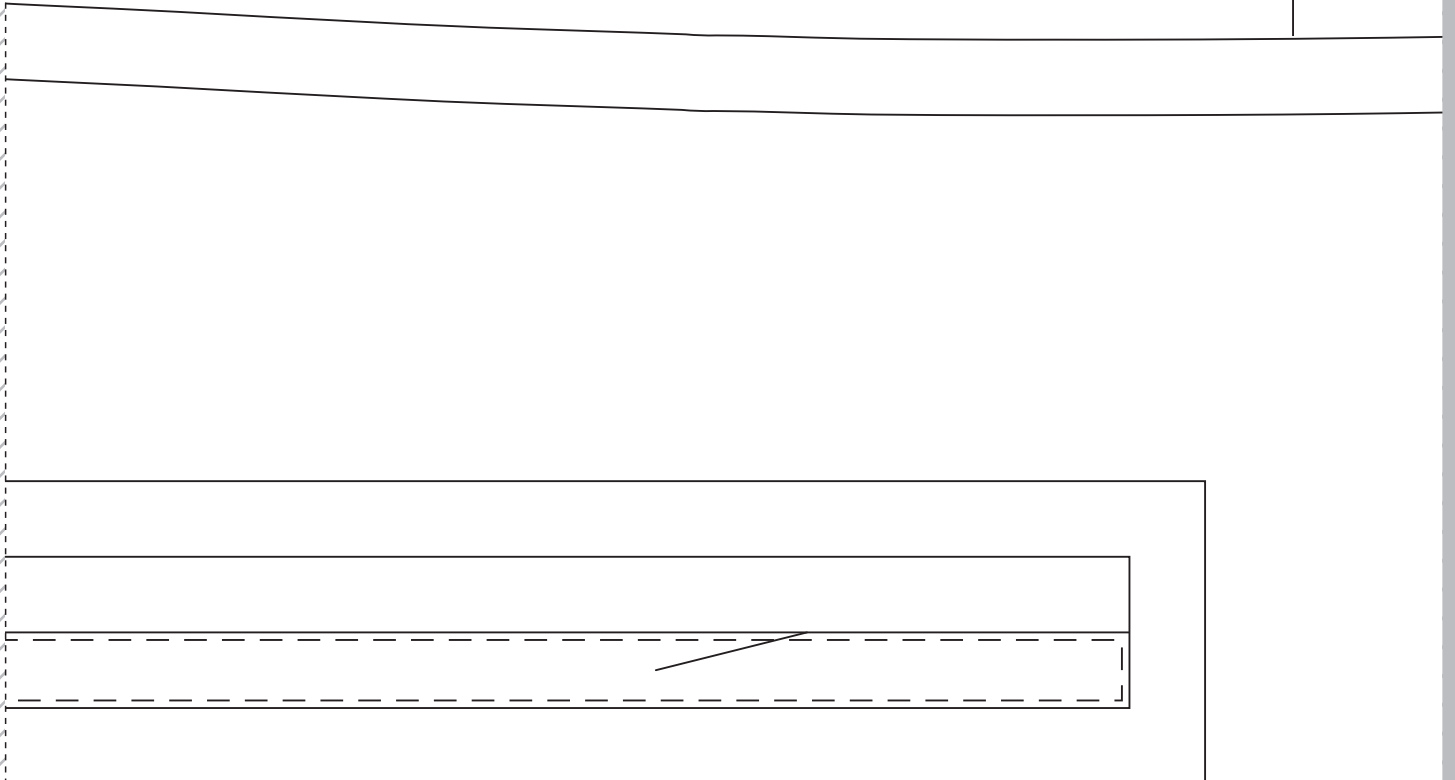

36

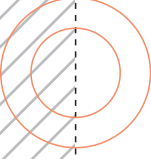
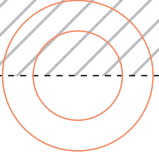

1.0



カフスと接ぐ

1.0