

## introduction はじめに

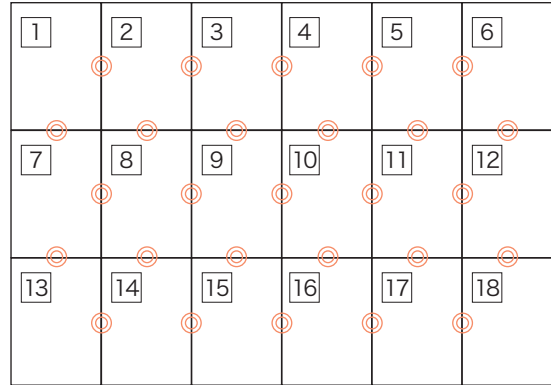

パターンは A4 サイズ 36 枚に分割されています。  
印刷後、右図のようにつなぎ合わせてください。

### ! 印刷時の注意

印刷設定では、「ページの拡大や縮小」を選択せず  
必ず、「実際のサイズ」(原寸) で印刷してください。



## how to make パターンのつくりかた

**STEP1** 斜線部分  は切り取り、灰色部分  は残してのりしろにします。  
(斜線と灰色を間違えないように注意)

**STEP2** 各用紙の番号を確認し、 の位置を合わせて、  
のりつけします。  
(水のりは用紙が波打ちます。スティック糊などをお使いください)

**STEP3** それぞれのパーツをハサミで切り出します。

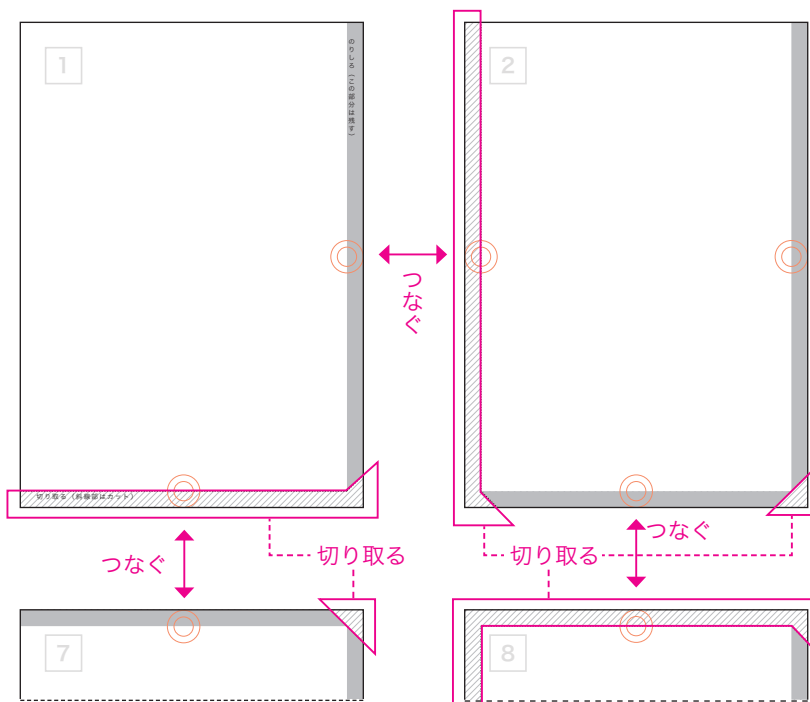
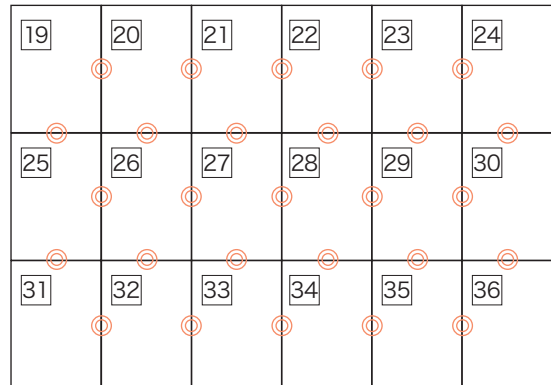

1

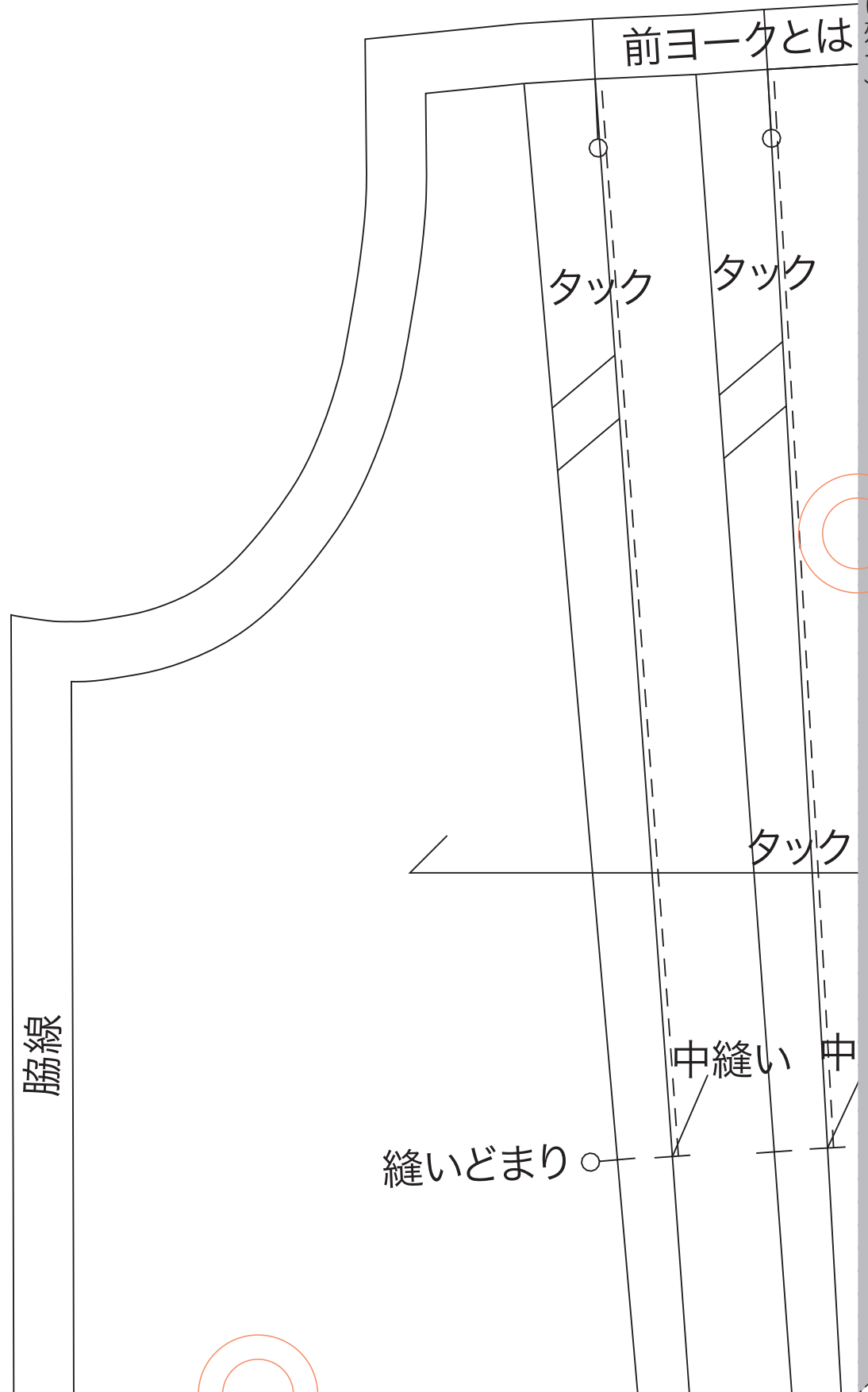

切り取る (斜線部はカット)

2

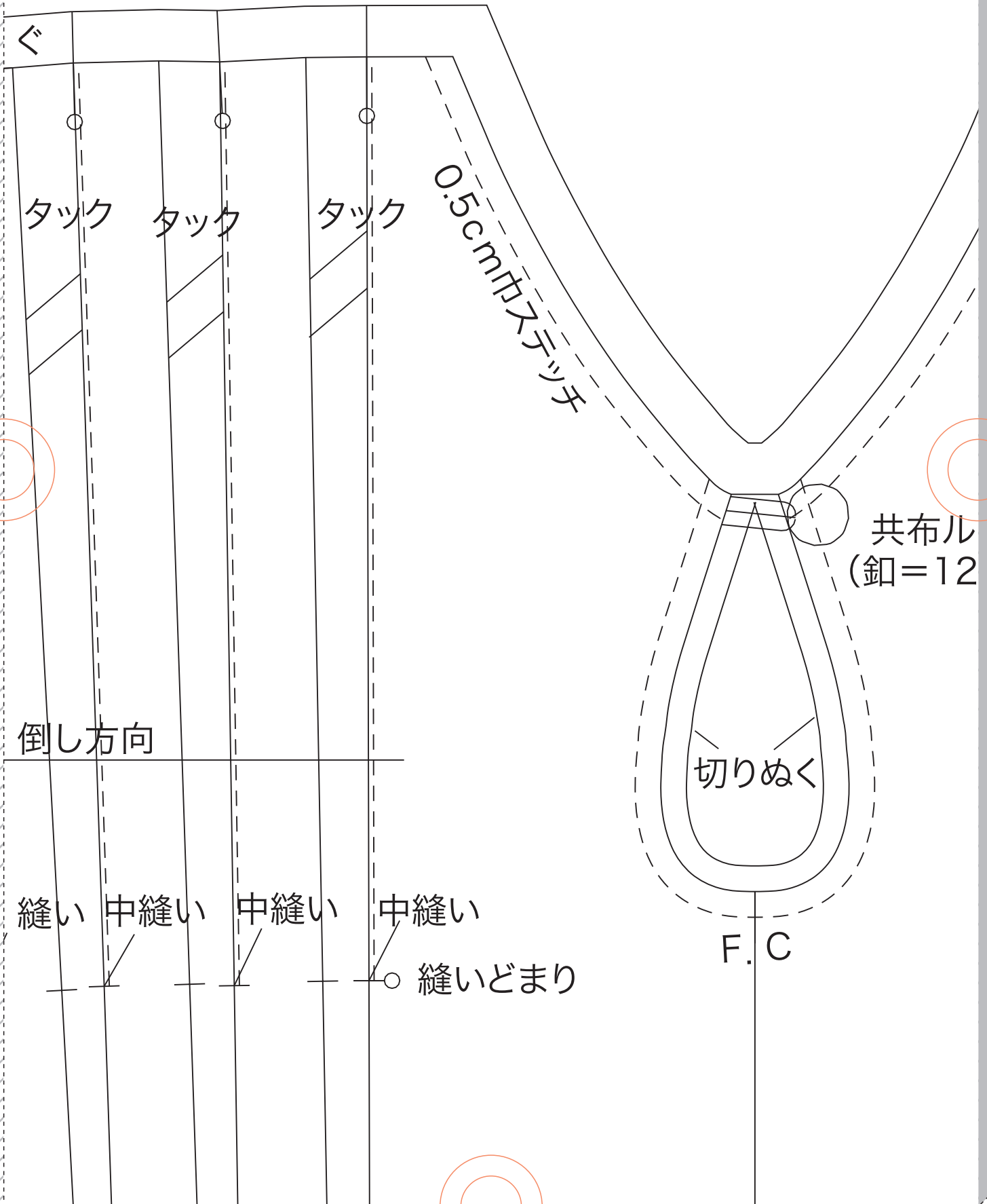

3

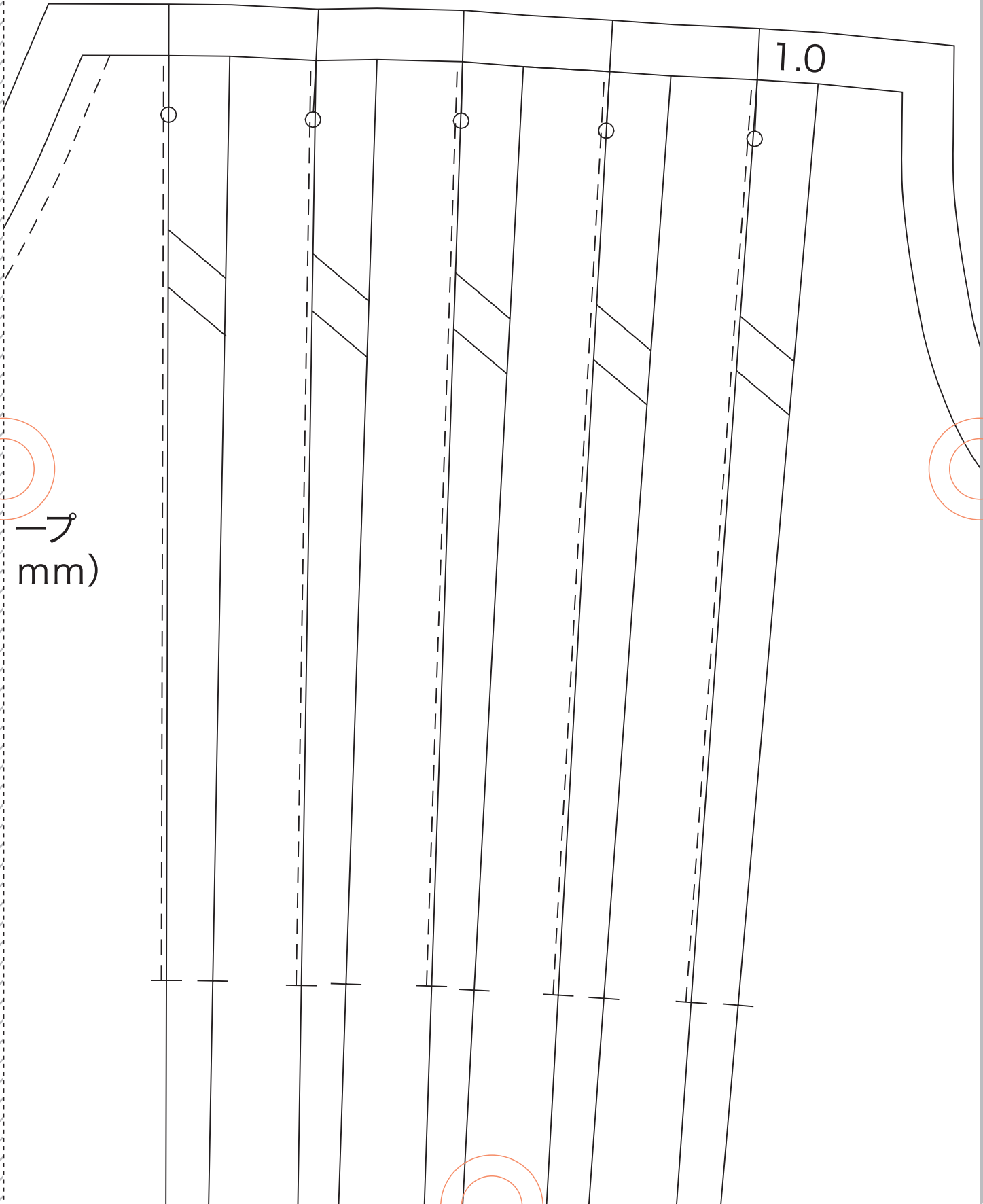

1.0

ープ  
mm)

4

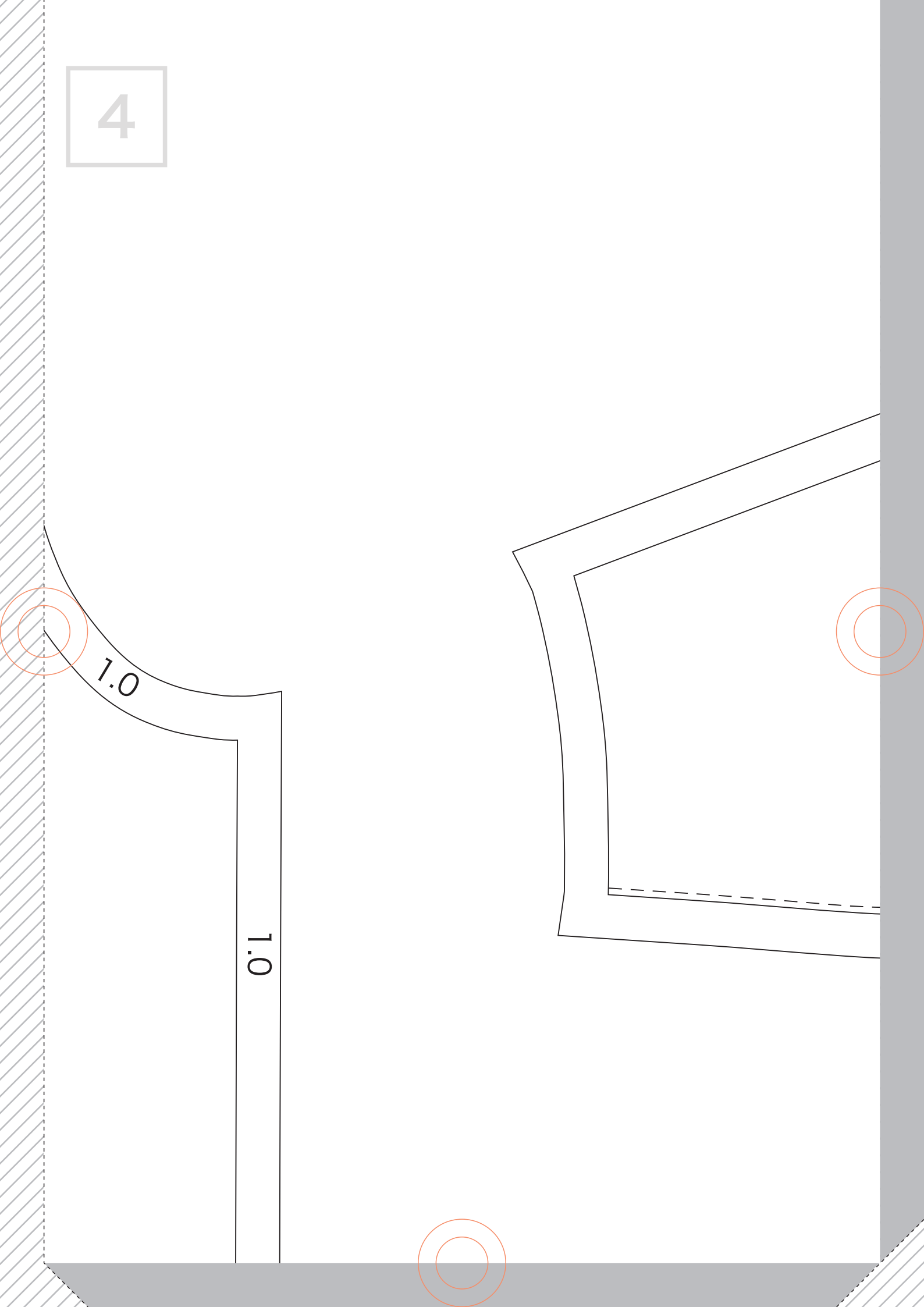

5

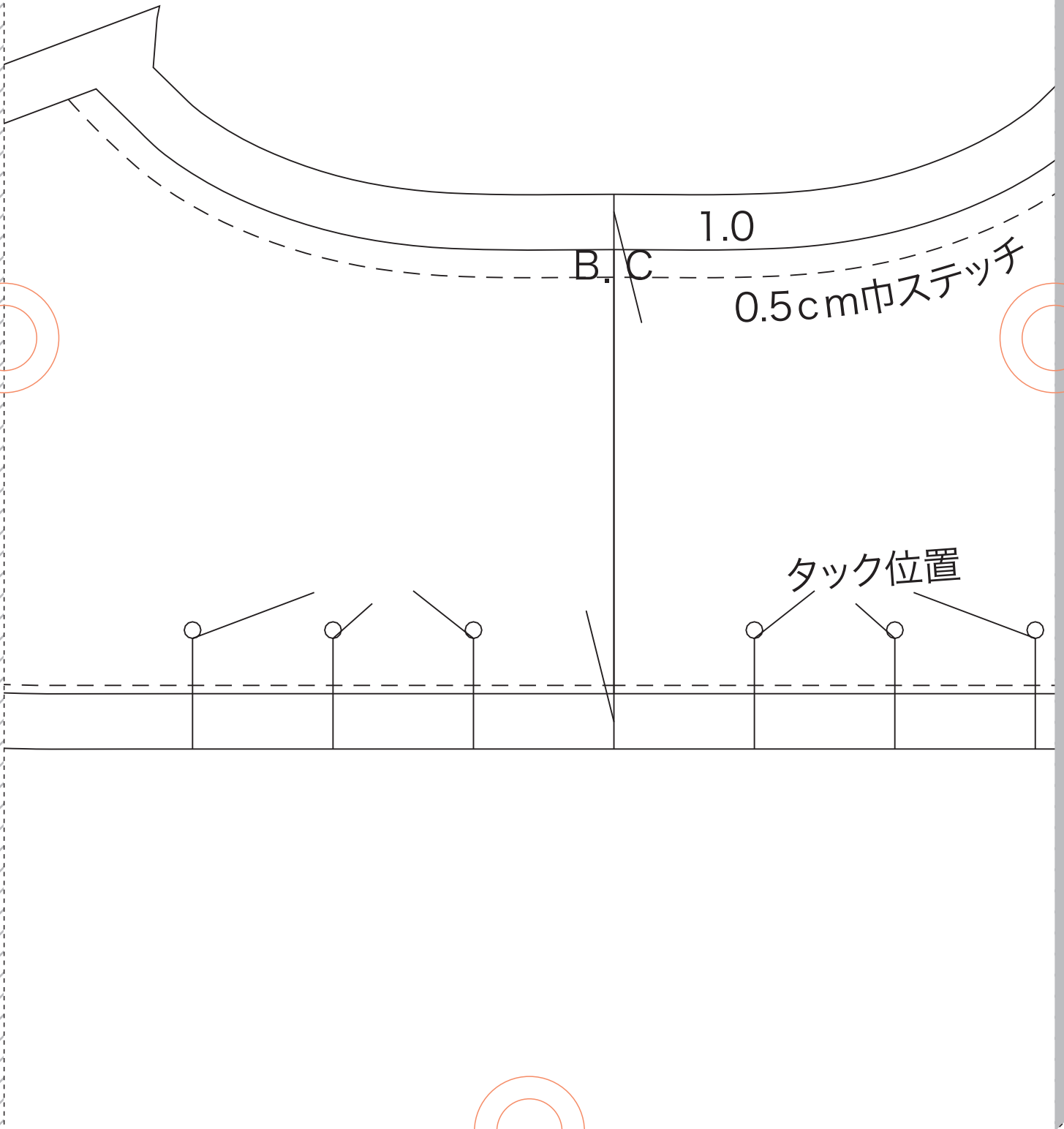

6

肩線

1.0

f a b f a b-4

後ヨーク

size : 9

表×1枚

1.0

コバステッチ

後身頃とはぐ

1.0

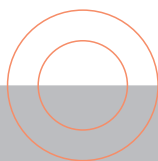

7

糸ループ 付く

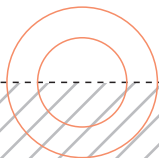
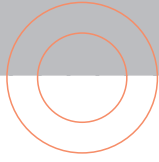



8

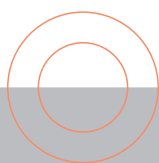
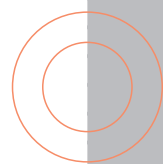
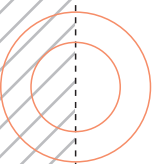
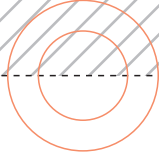
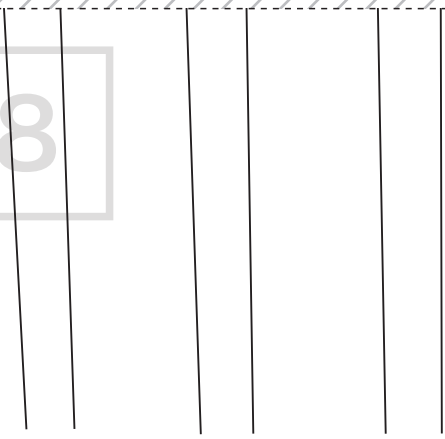

9

f a b f a b-4

前身頃

size : 9

表×1枚

10

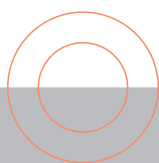
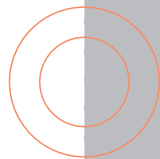
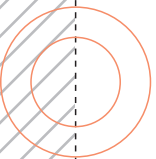
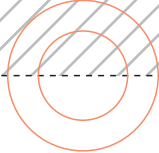

11

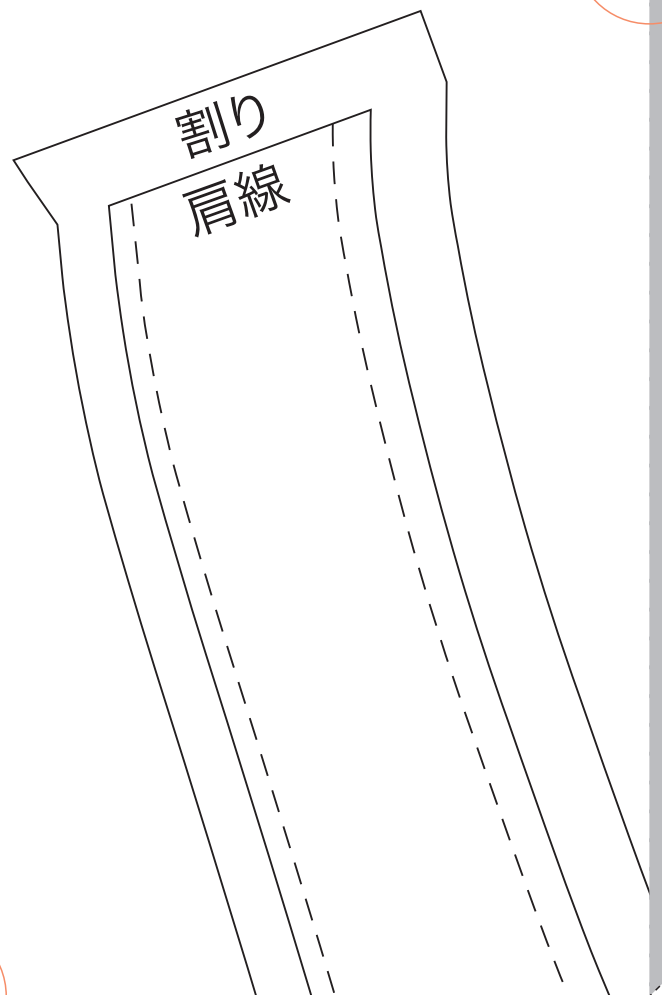

12

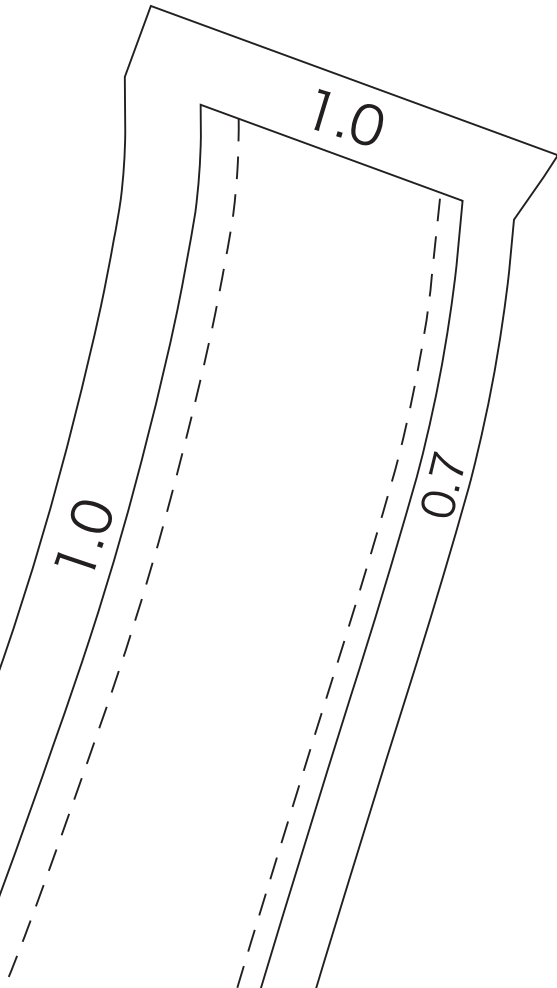
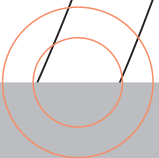
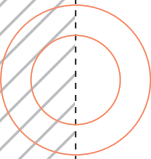
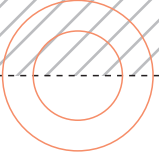

13

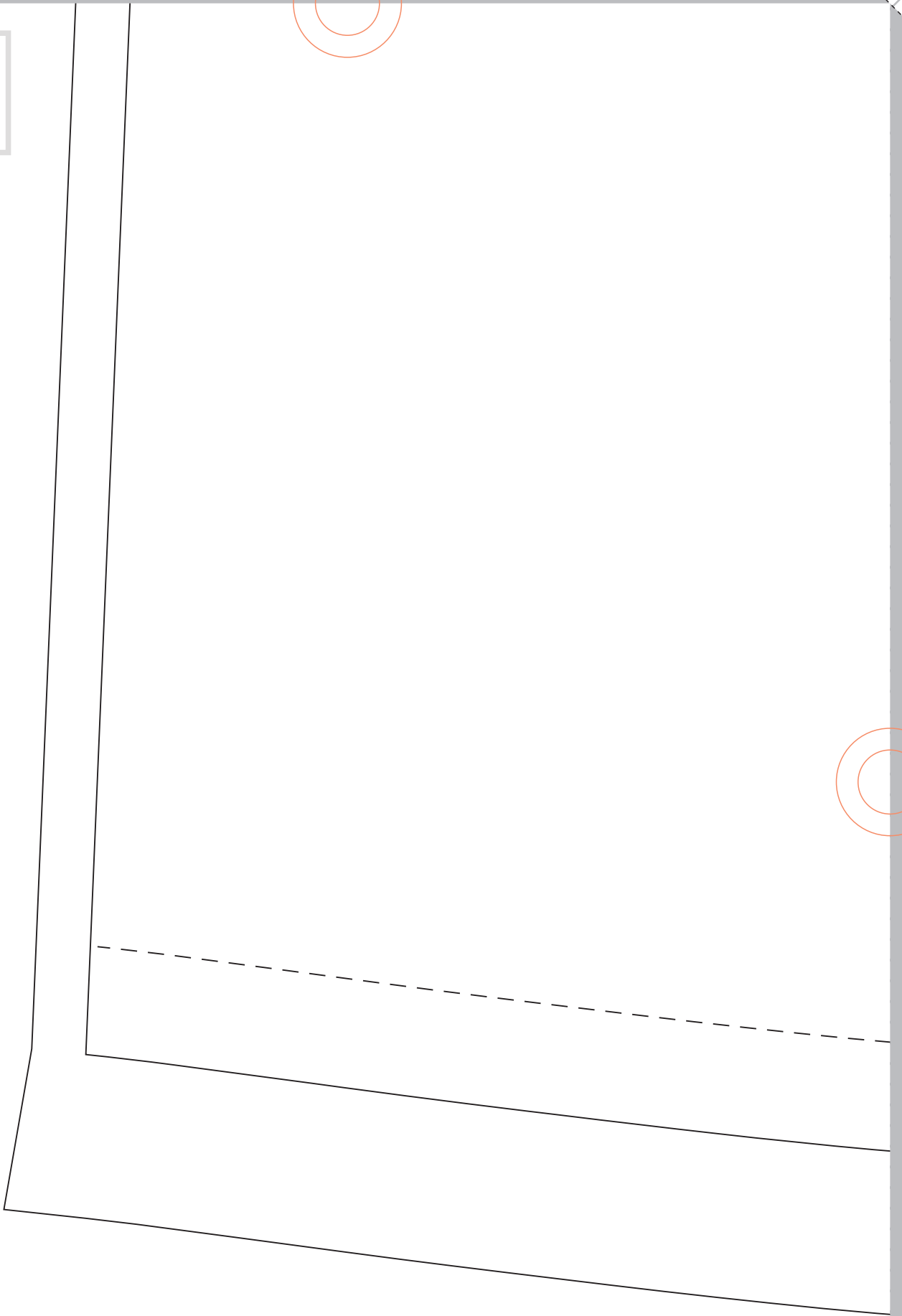
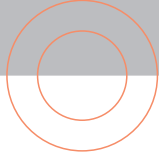

14

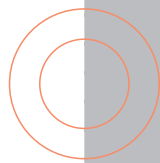
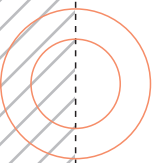
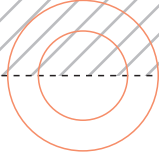

3つ折りして2cm幅ステッチ

裾出来上がり線

15

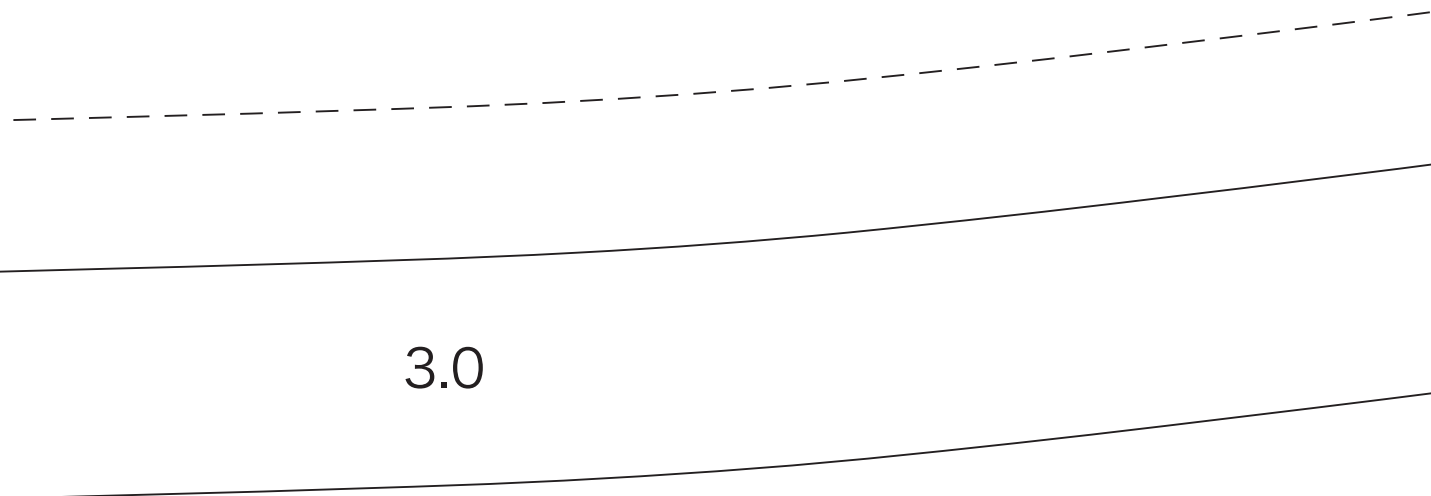
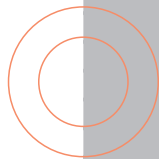
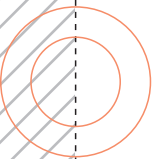
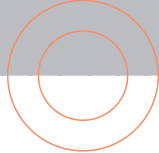

3.0



16

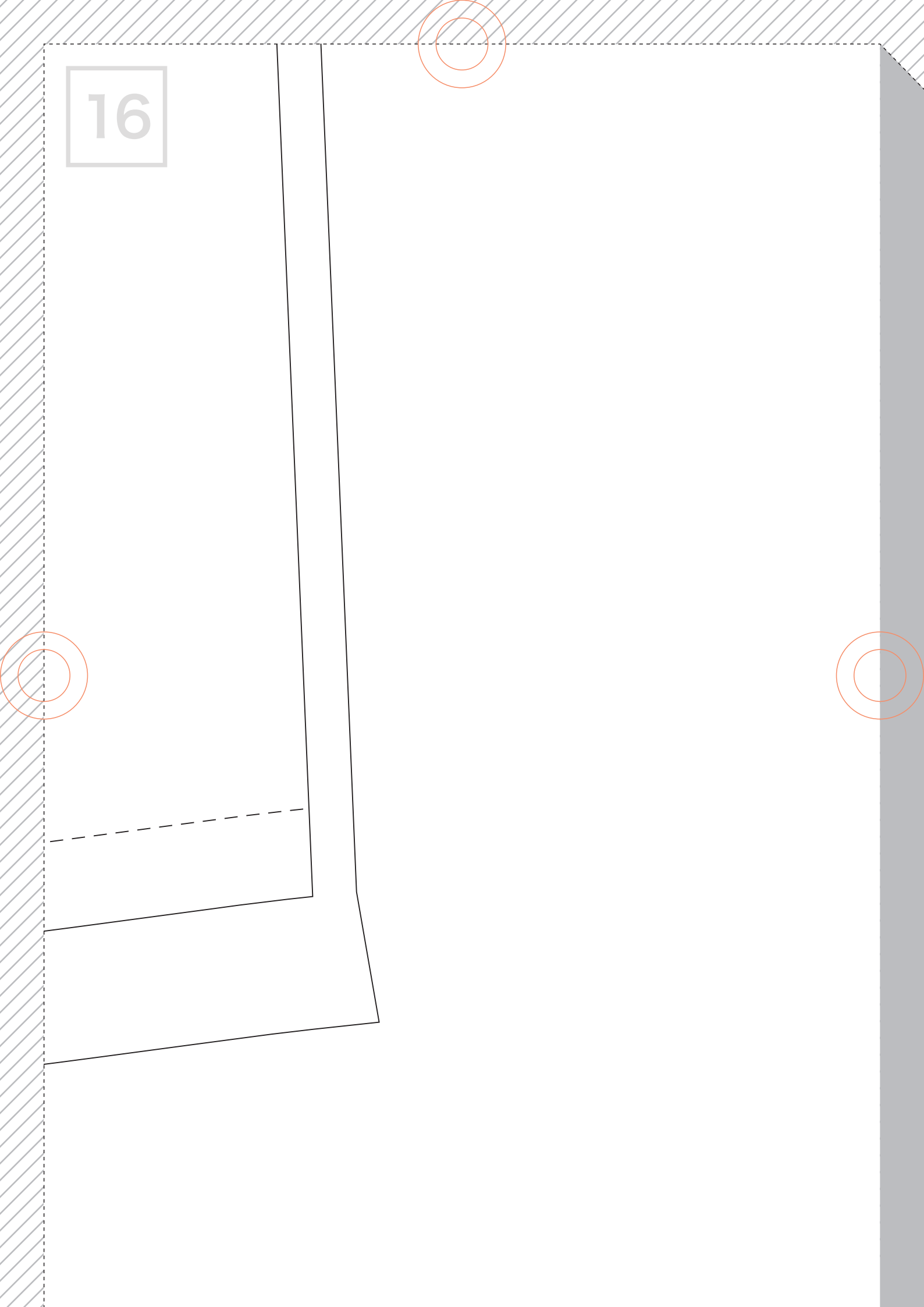
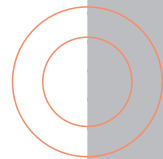
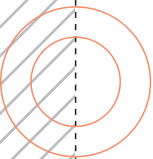
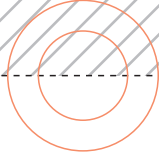

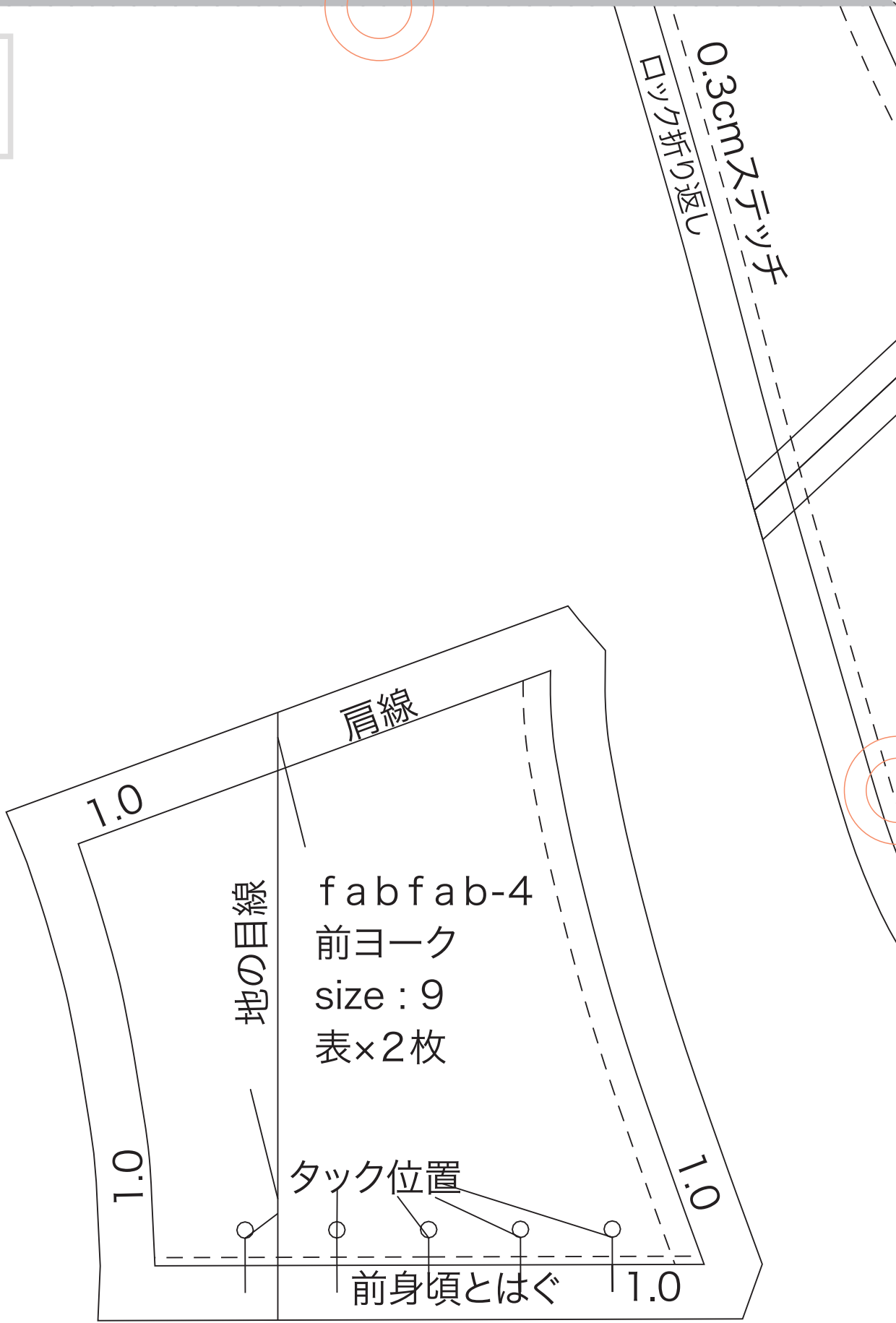

18

f a b f a b - 4  
前衿ぐり見返し  
size : 9  
表×1枚  
芯×1枚

F.C

切りぬく

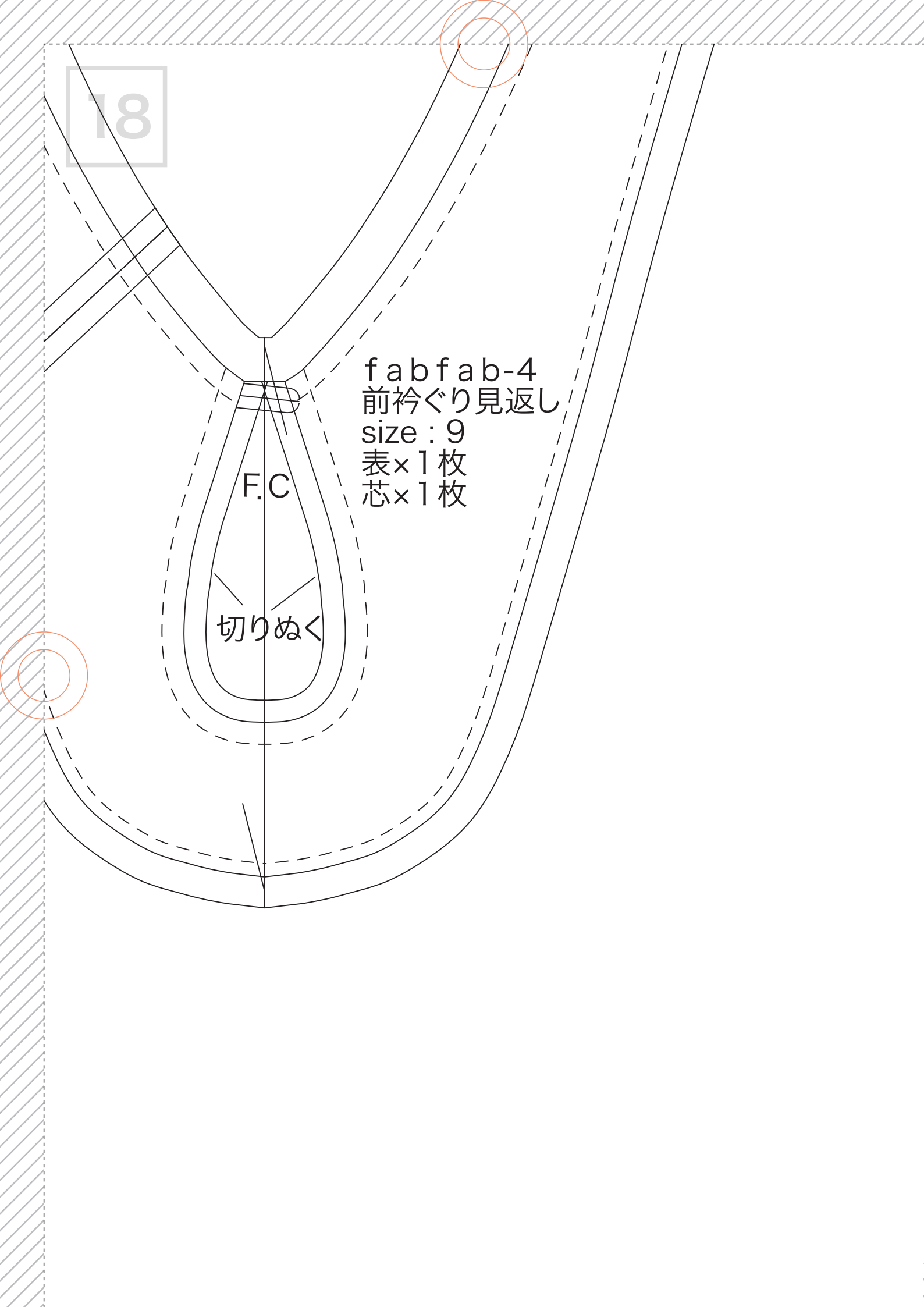

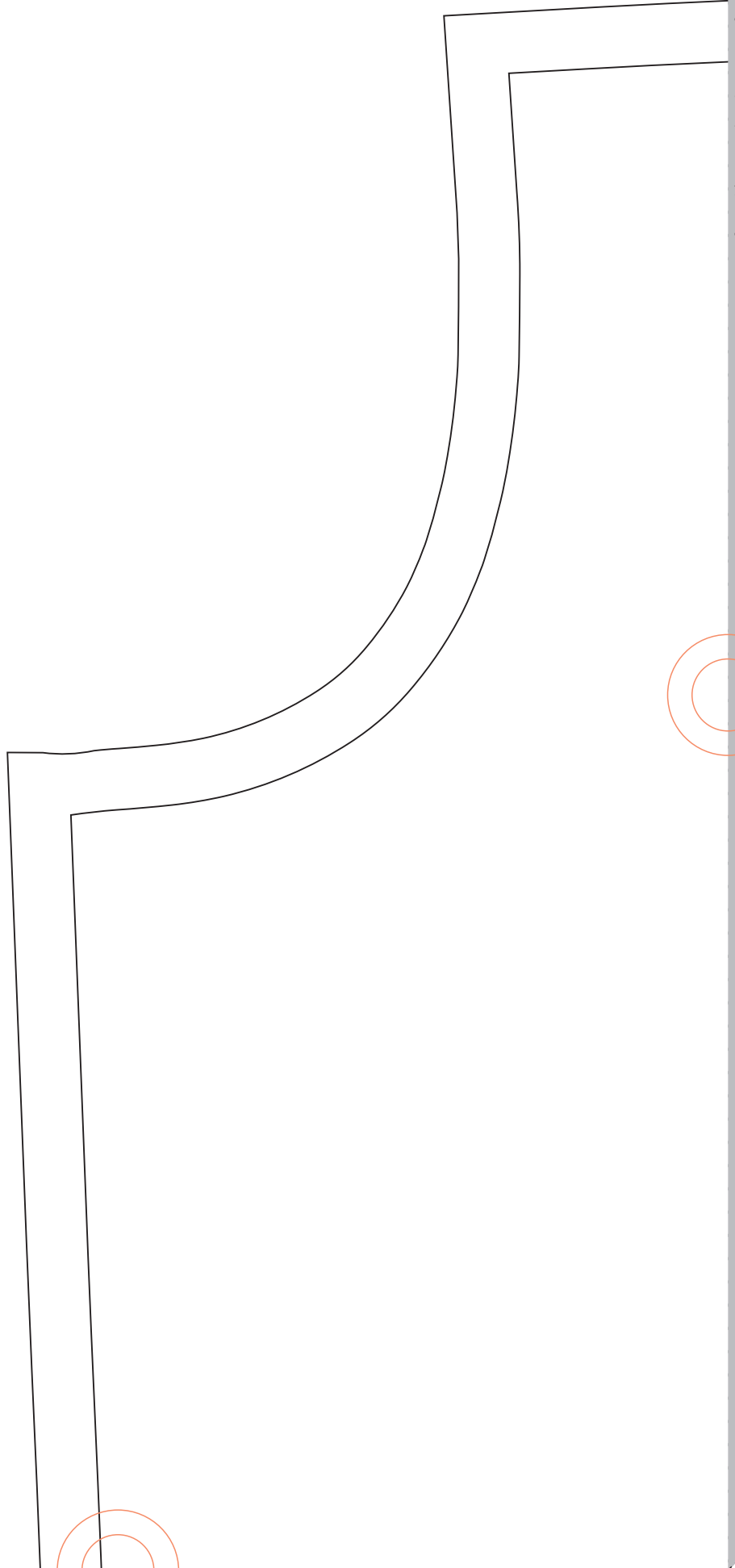

切り取る (斜線部はカット)

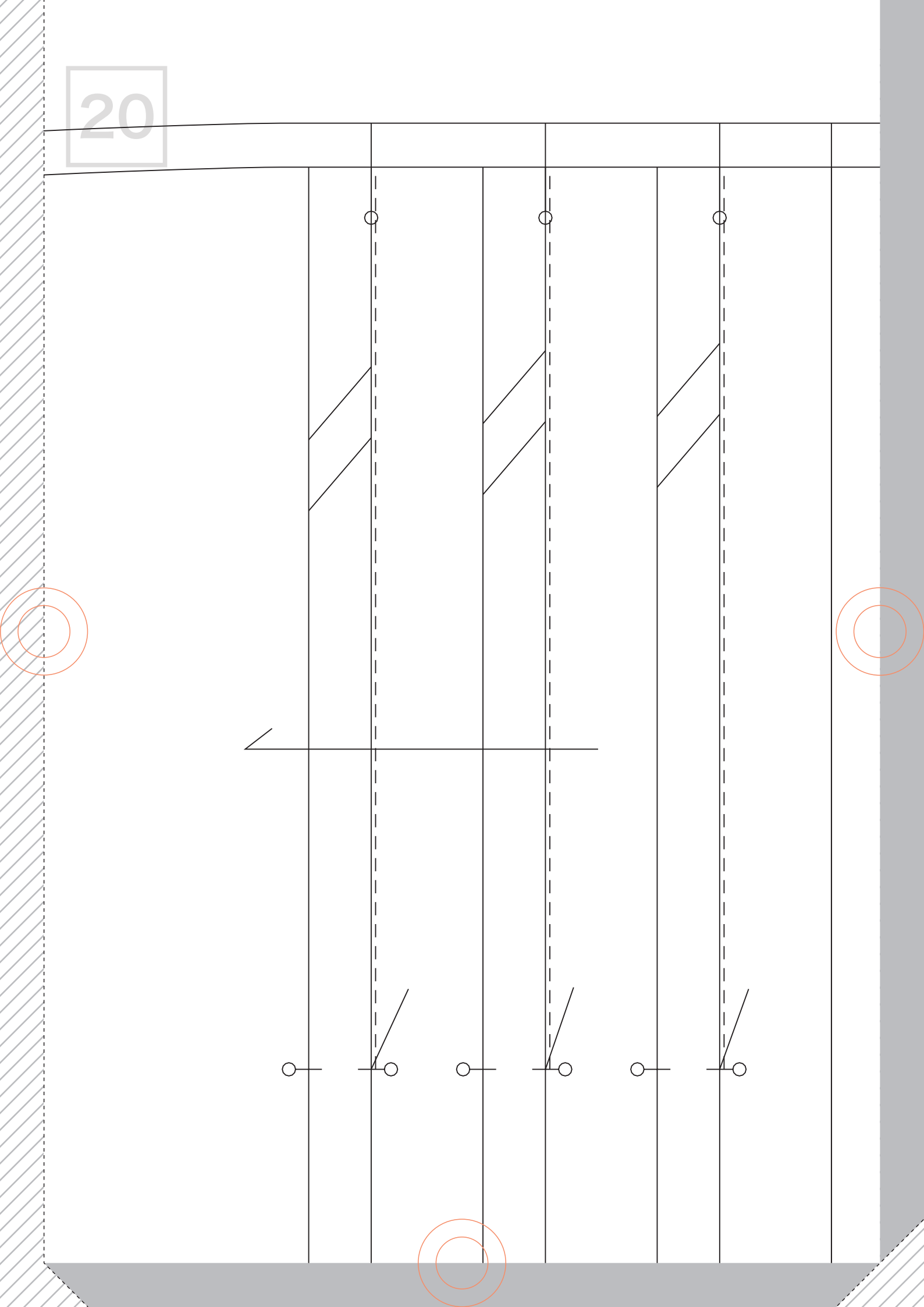

後ヨークとはぐ

1.0

タック

タック

タック

タック倒し方向

中縫い

中縫い

中縫い

縫いどまり

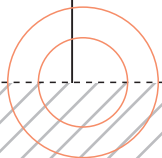
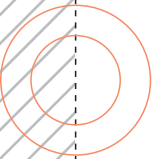

22

1.0

1.0

脇線

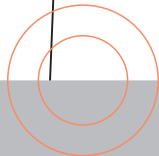
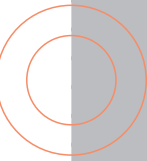
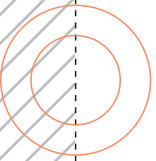

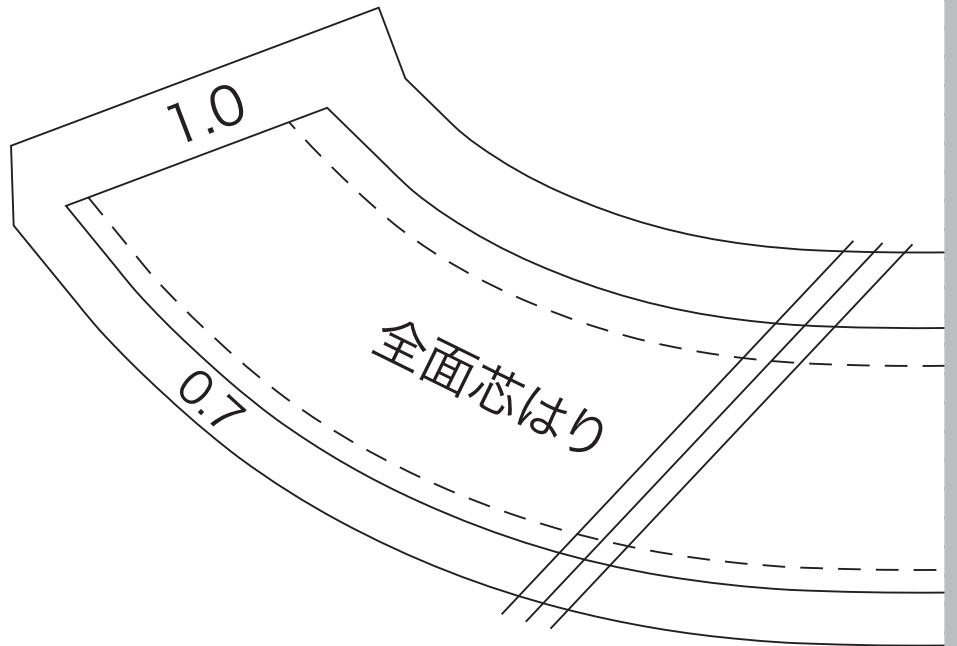
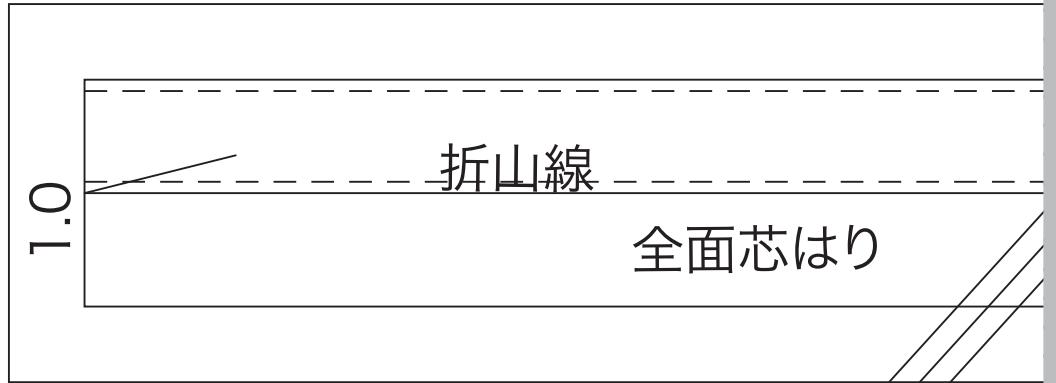



24

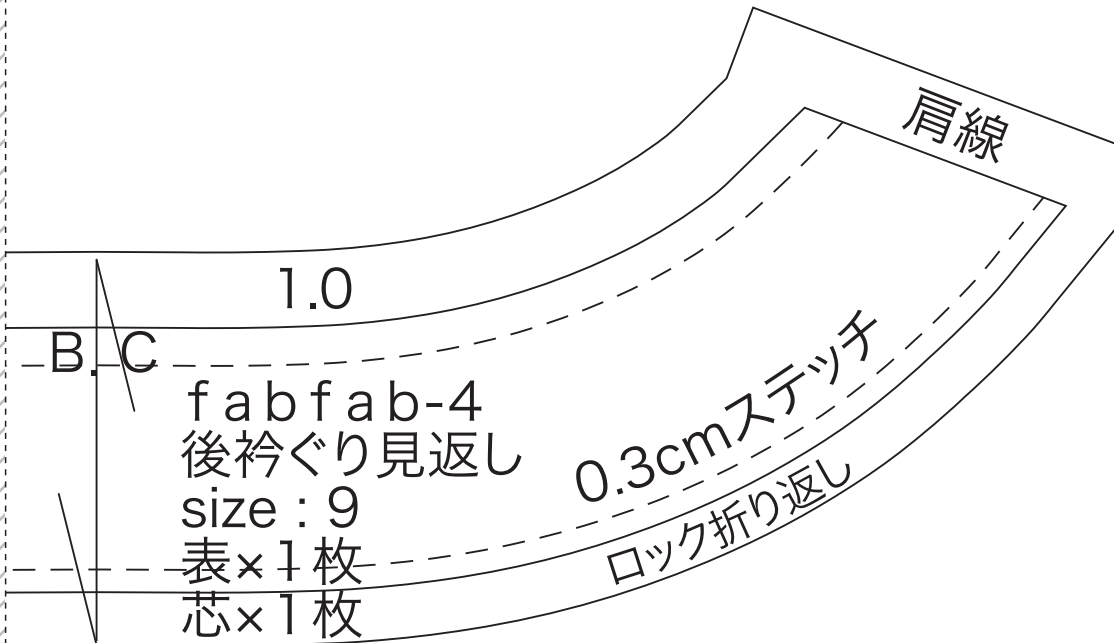
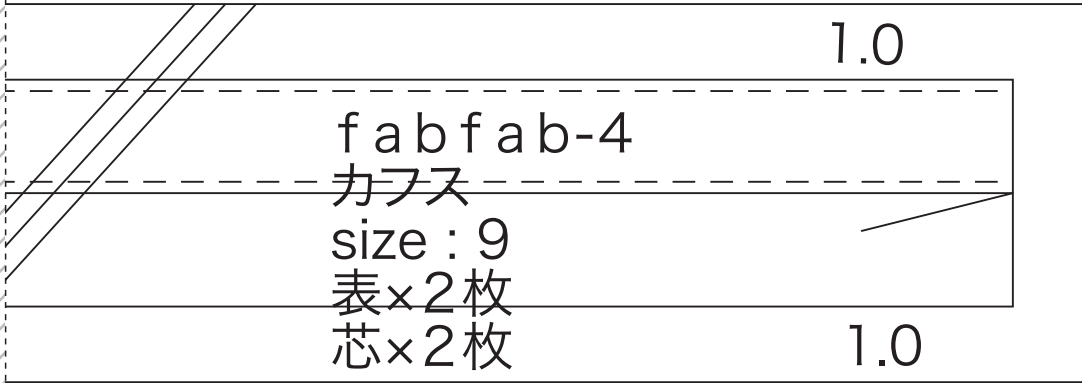

25

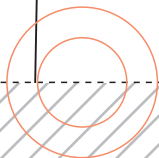
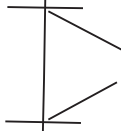
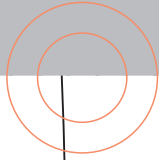

26

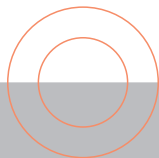
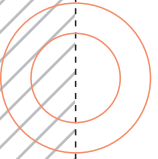
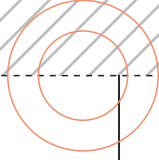

27

f a b f a b-4

後身頃

size : 9

表×1枚

28

糸ループ 付く

袖下

後ろ

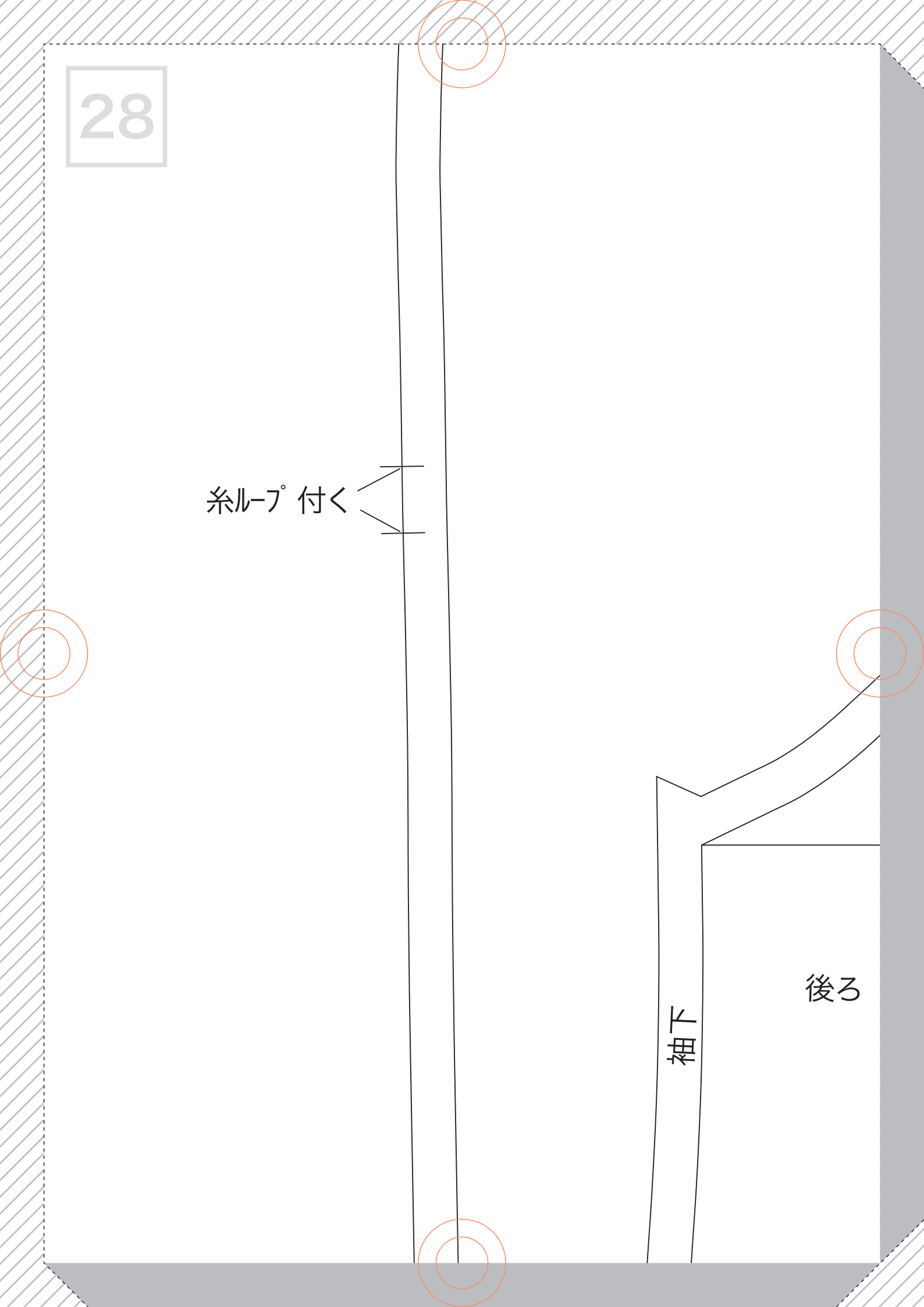

29

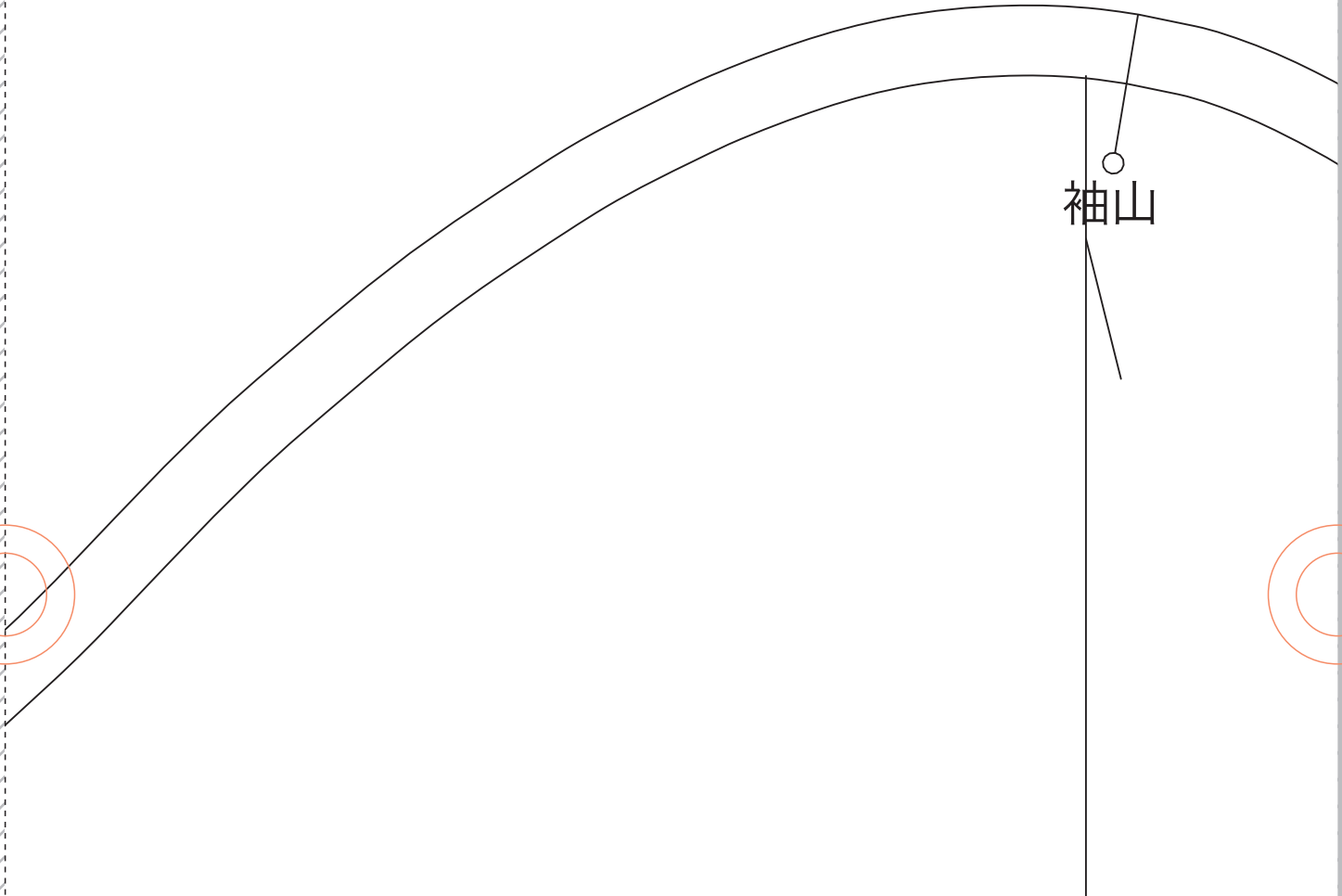

袖山

f a b f a b - 4  
袖  
size : 9  
表 × 2 枚

地の目線

30

	fabfab-4
	ループ
	size: 9
	表×1枚

1.0

前

畚下

31

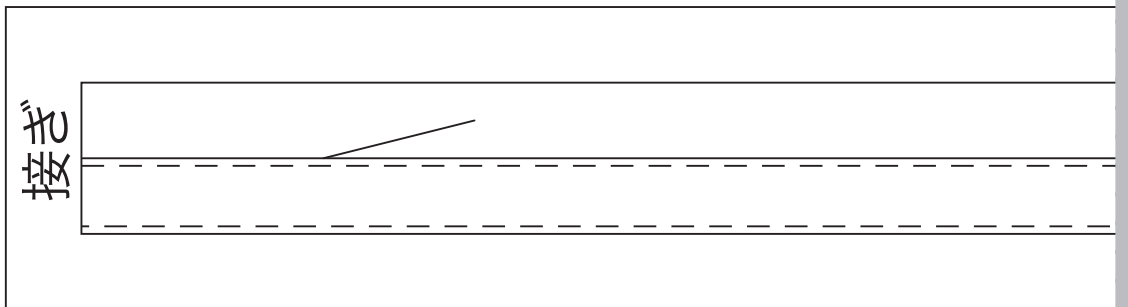
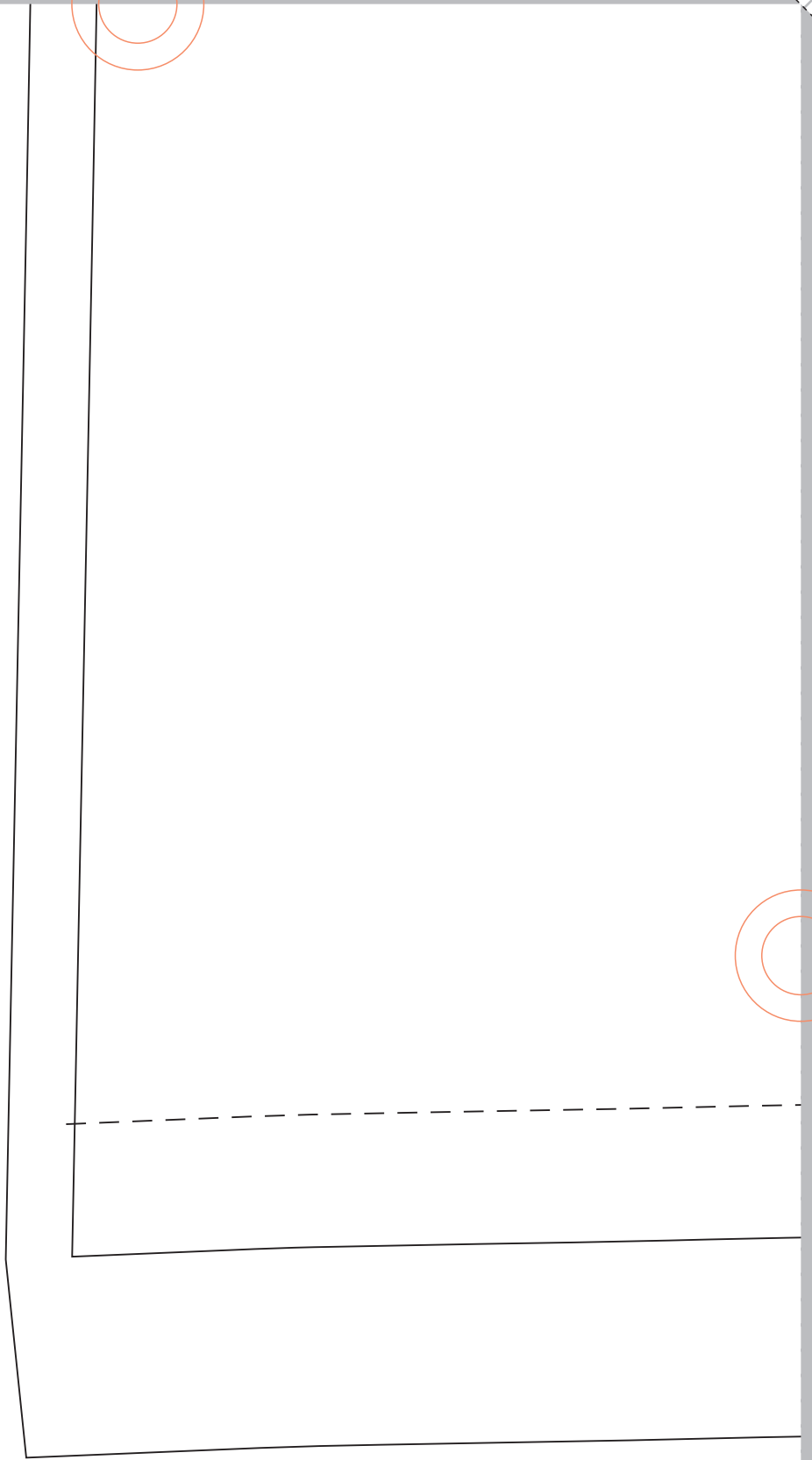
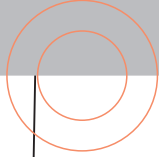



32

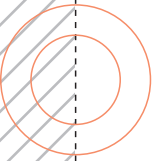
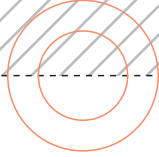

1.0

33

3つ折りして2cm幅ステッチ

裾出来上がり線

3.0

f a b f a b-4

リボン

size : 9

表×2枚

34

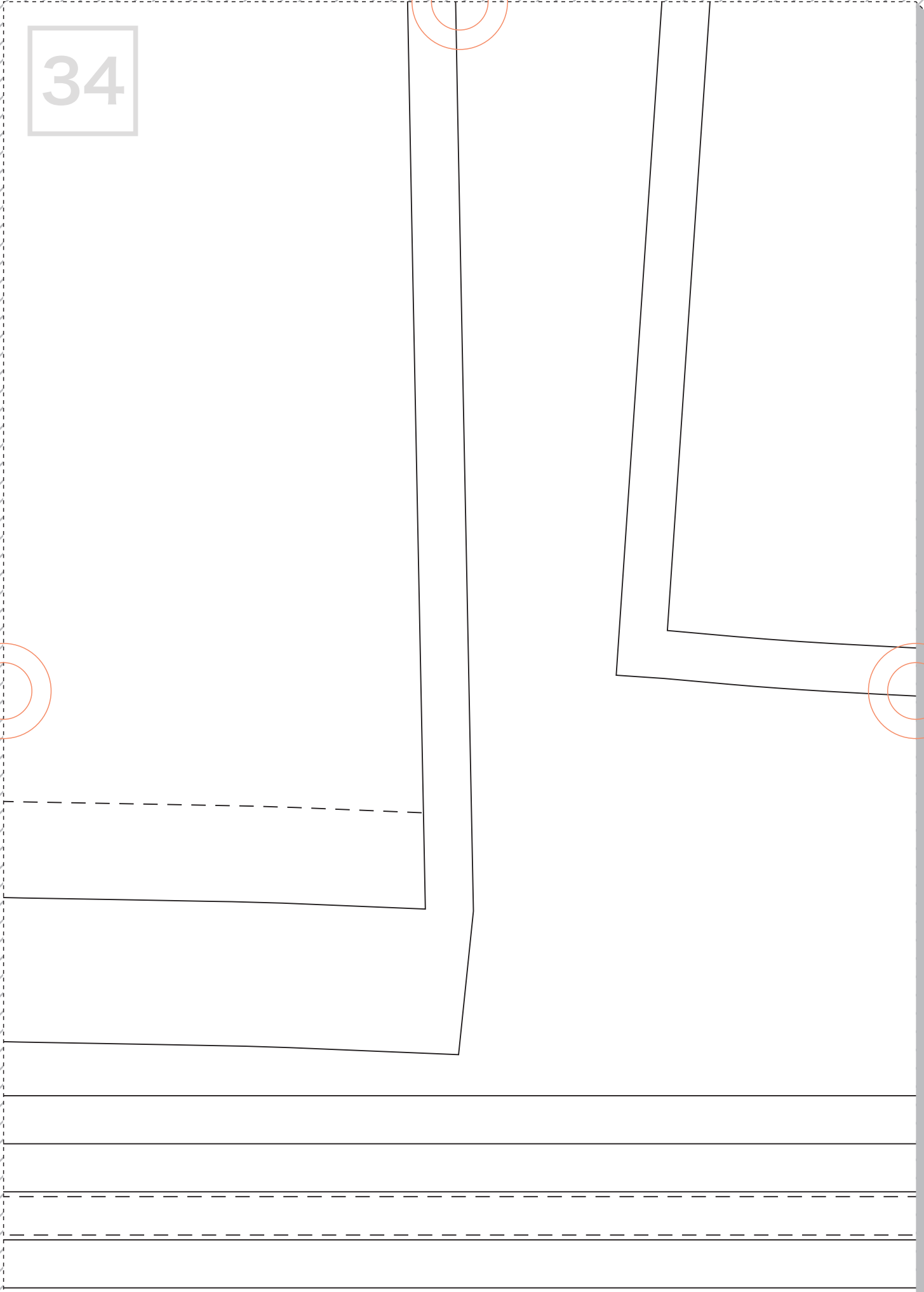
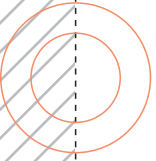
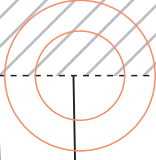

35

ギャザー均等に寄せる

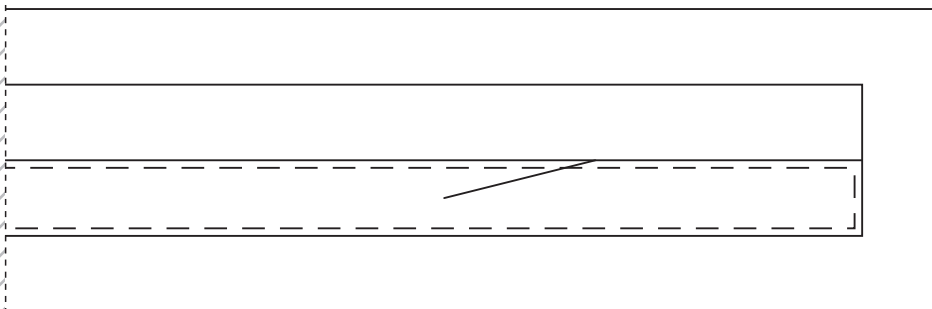

36

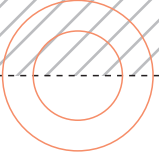

1.0



カフスと接ぐ

1.0

