



introduction はじめに

パターンは A4 サイズ 60 枚に分割されています。
印刷後、右図のようにつなぎ合わせてください。

! 印刷時の注意

印刷設定では、「ページの拡大や縮小」を選択せず
必ず、「実際のサイズ」(原寸) で印刷してください。

how to make パターンのつくりかた

STEP1 斜線部分  は切り取り、灰色部分  は残してのりしろにします。
(斜線と灰色を間違えないように注意)

STEP2 各用紙の番号を確認し、 の位置を合わせて、のりづけします。
(水のりは用紙が波打ちます。スティック糊などをお使いください)

STEP3 それぞれのパーツをハサミで切り出します。

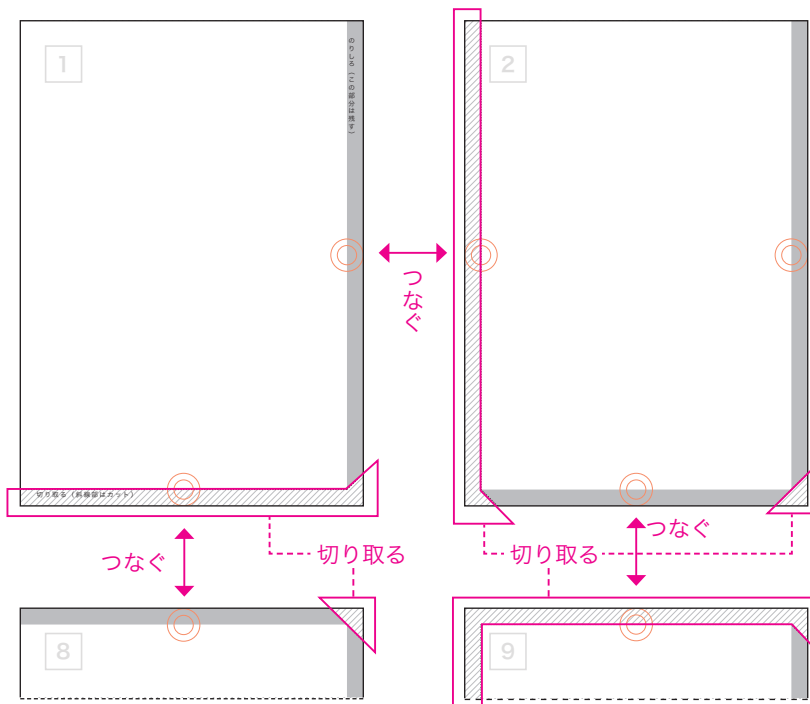
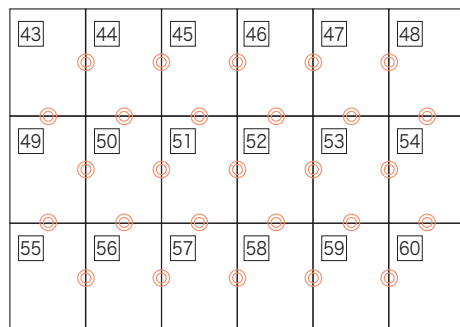
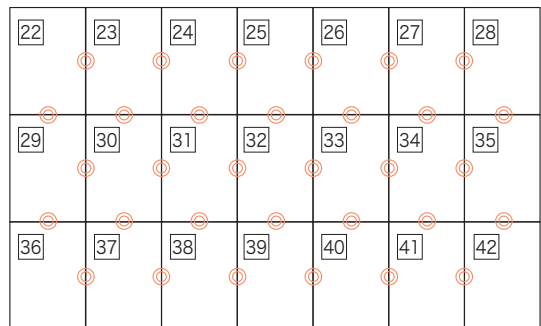
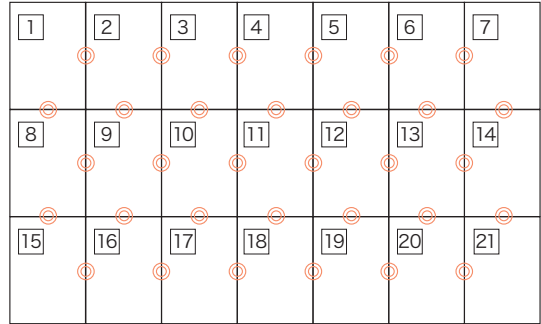

1

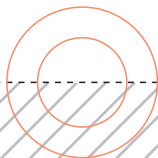

2

右脇

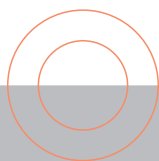
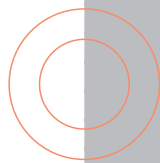
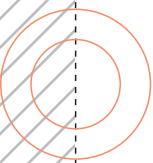

3

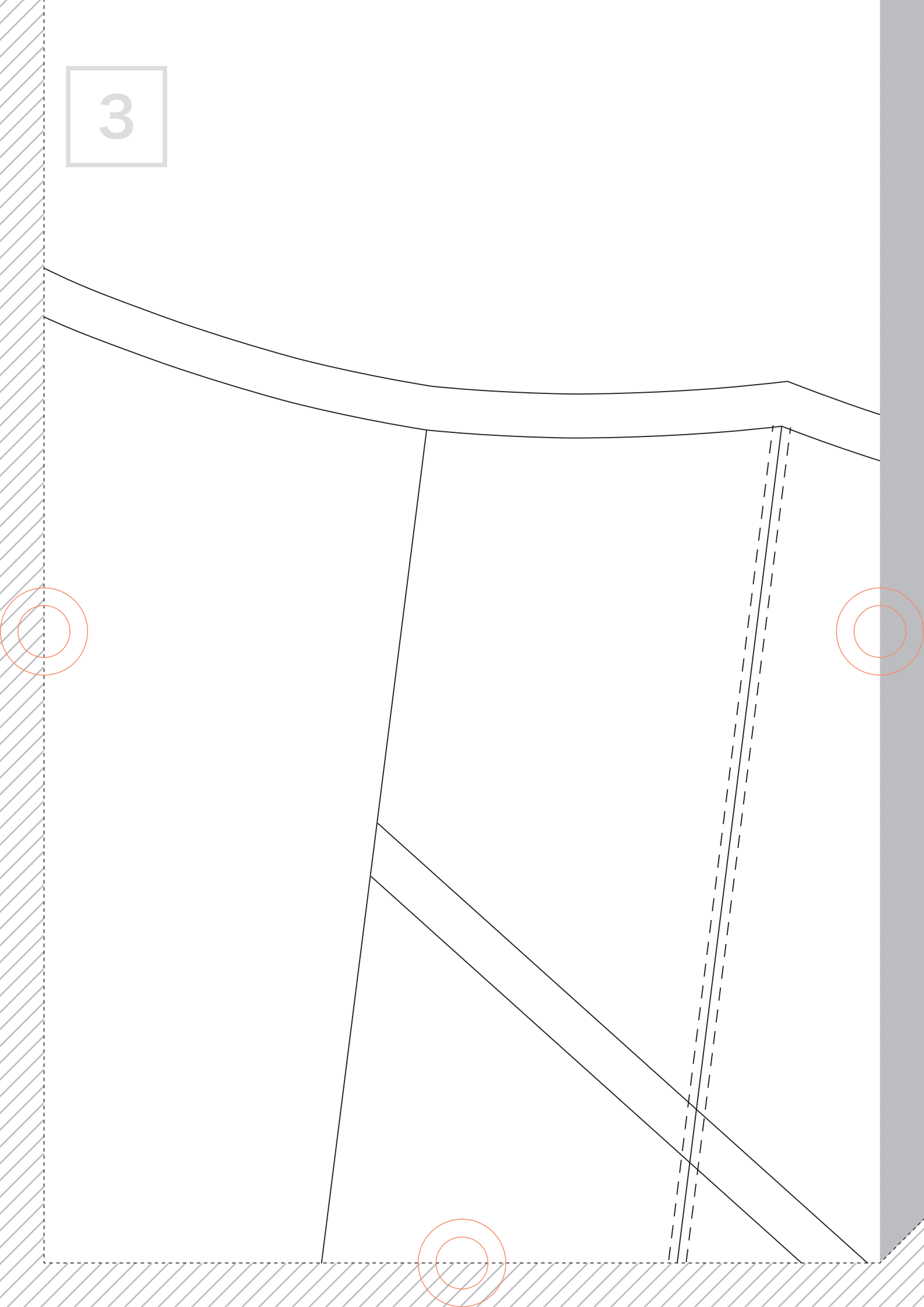

4

F. C

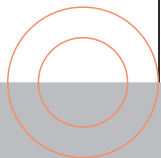
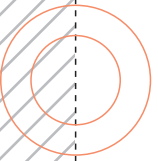

5

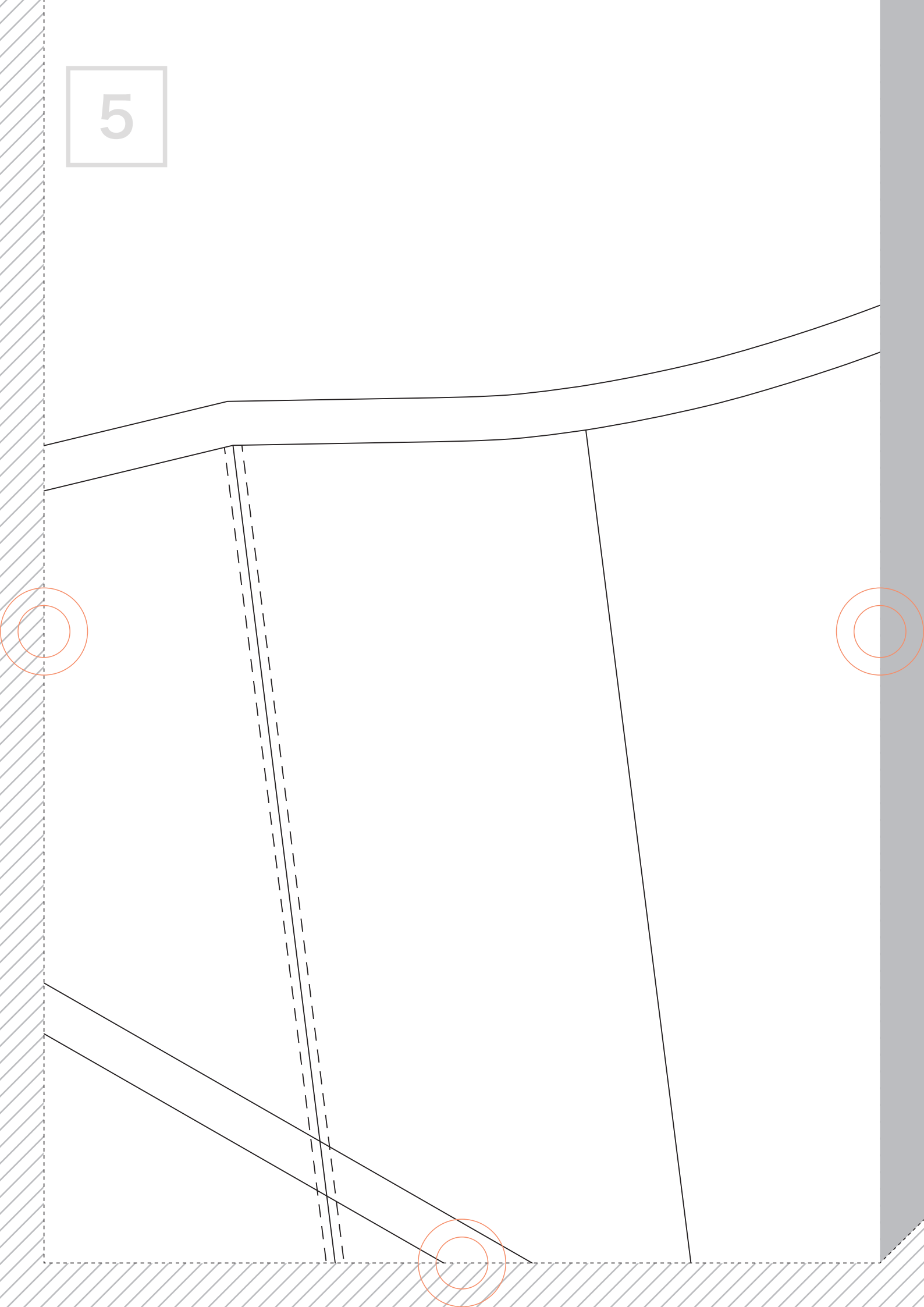

6

1.0

左脇

15mm伸び止めテープ

ファスナー開き止まり

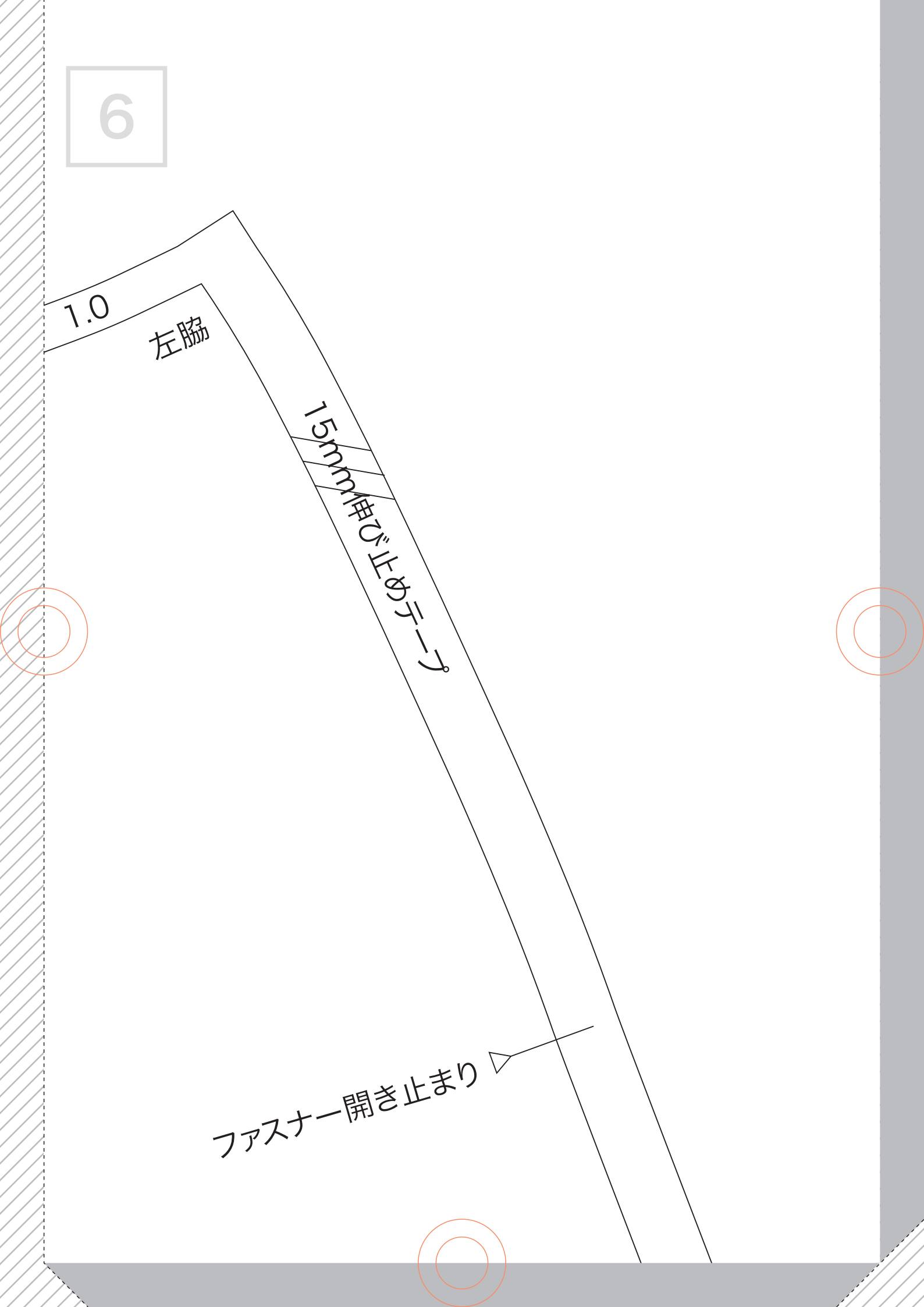

7

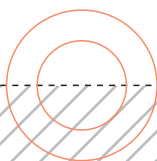
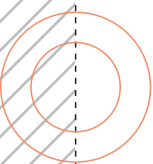

8

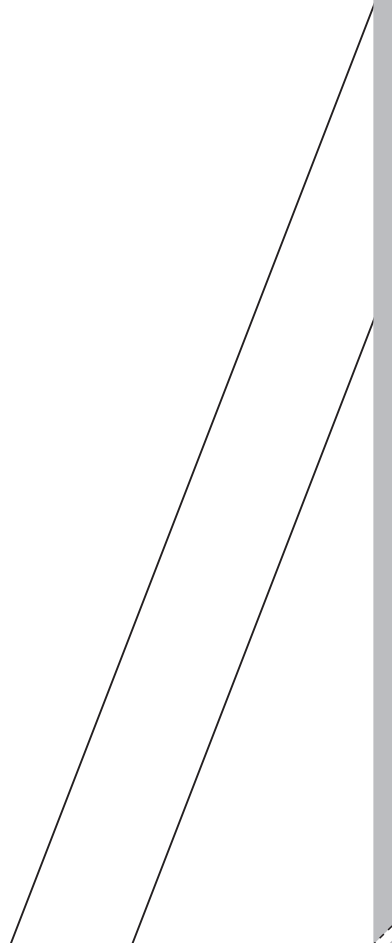
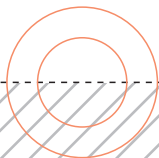
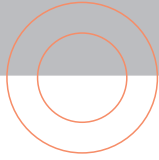

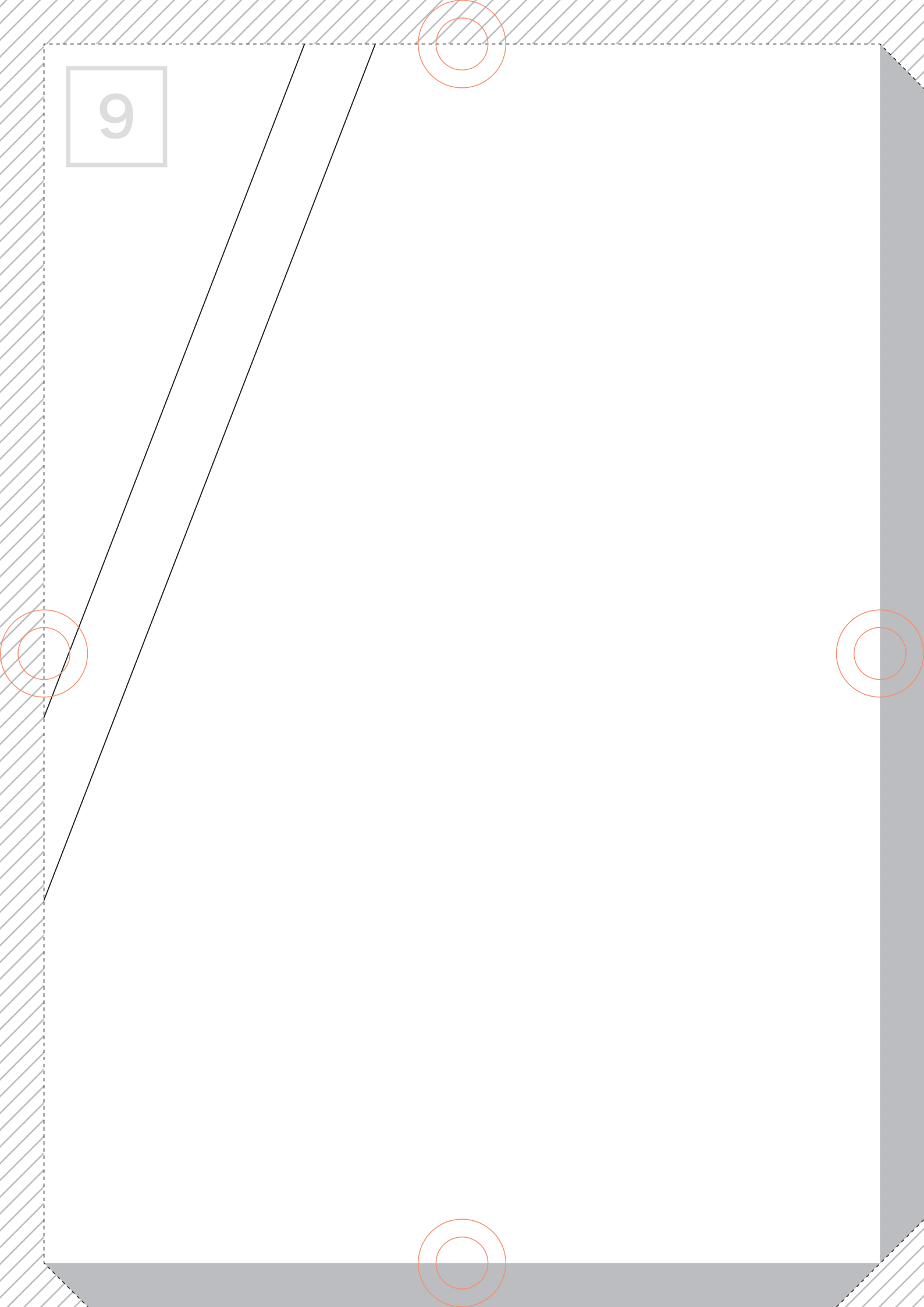

9

10

タックの方向

ひだ奥ステッチ0.2cm幅

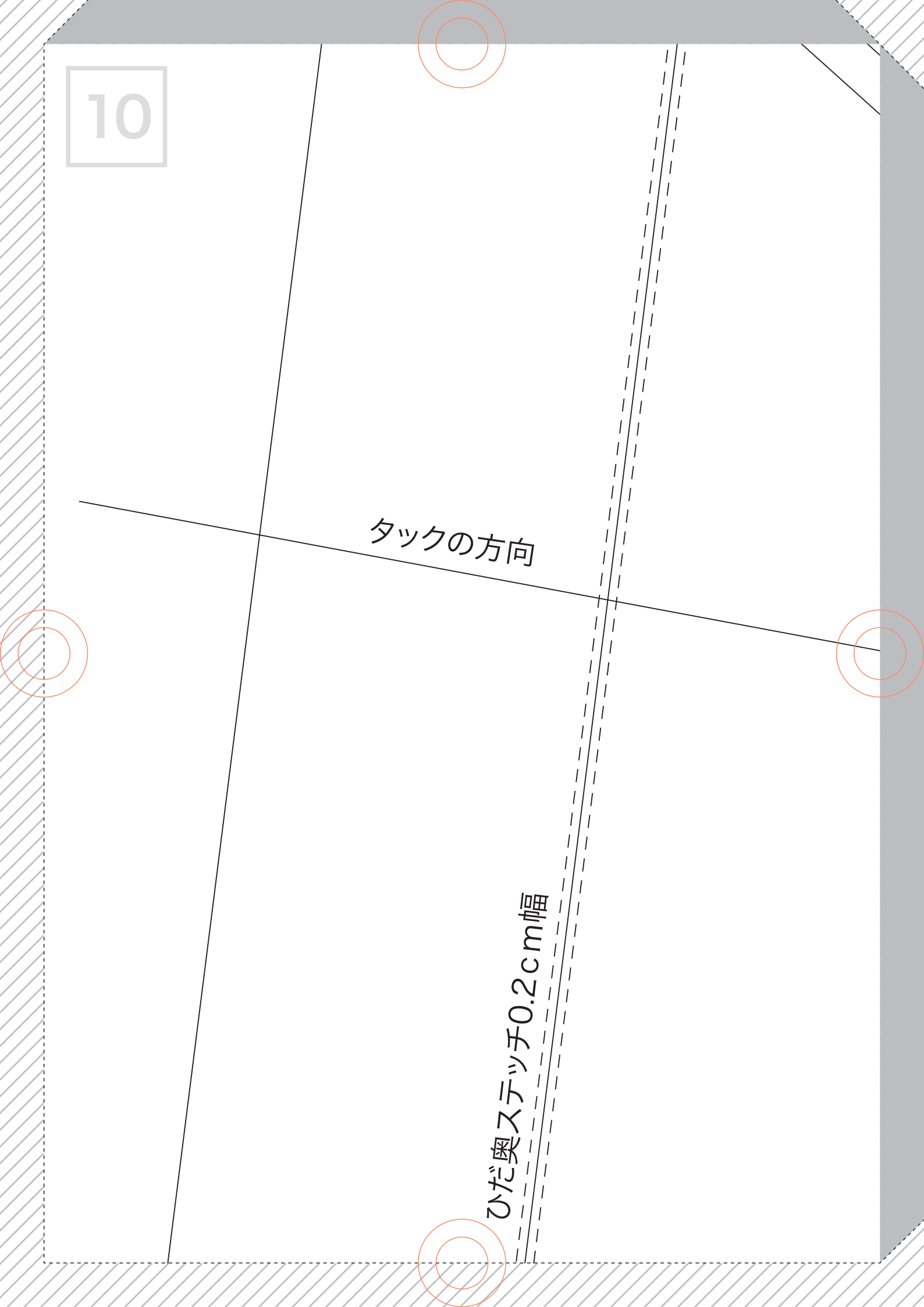

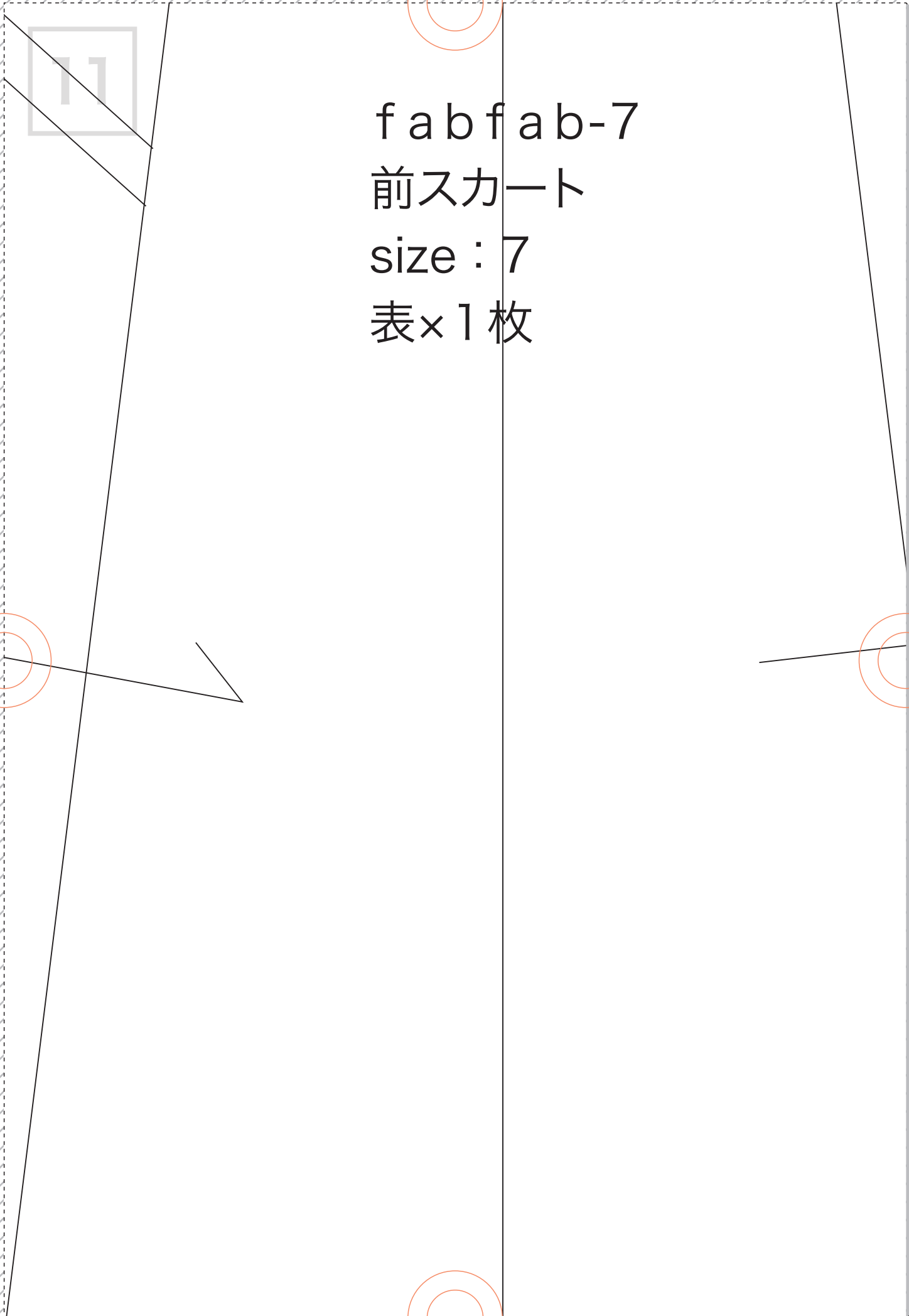

11

f a b f a b - 7

前スカート

size : 7

表 x 1 枚

12

タックの方向

ひだ奥ステッチ0.2cm幅

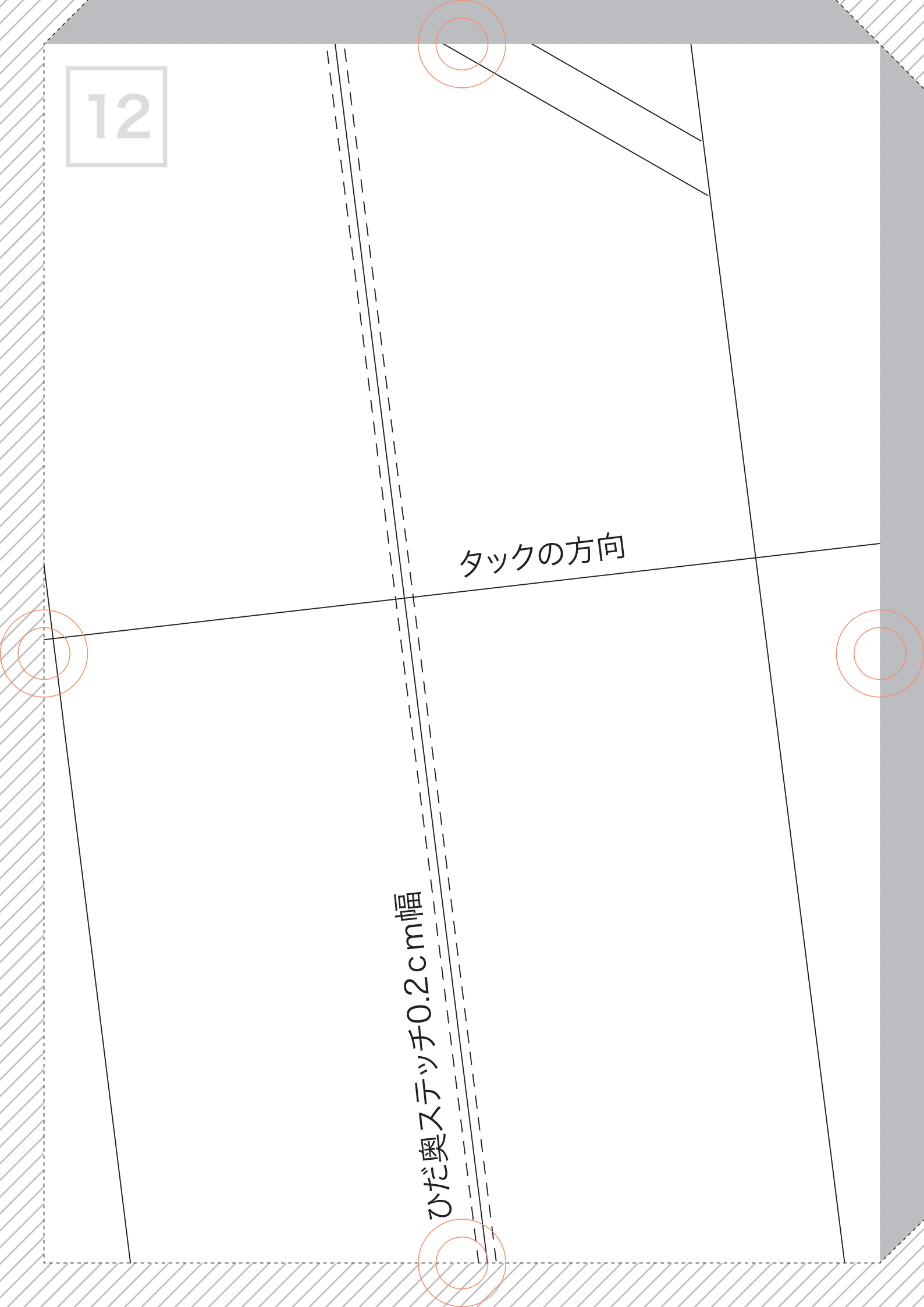

13

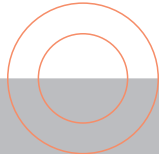
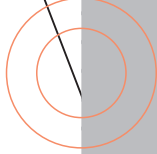
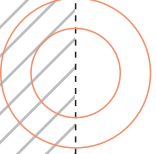
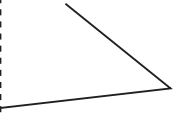
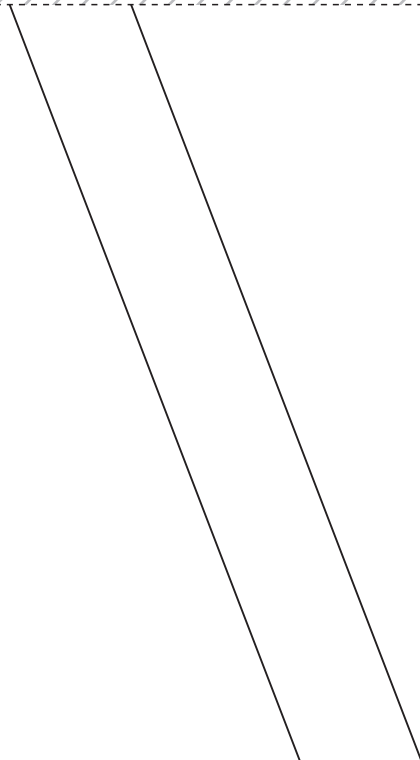
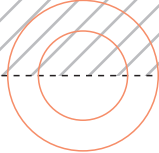

14

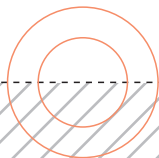
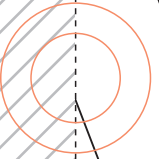
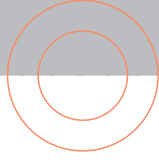

1:5

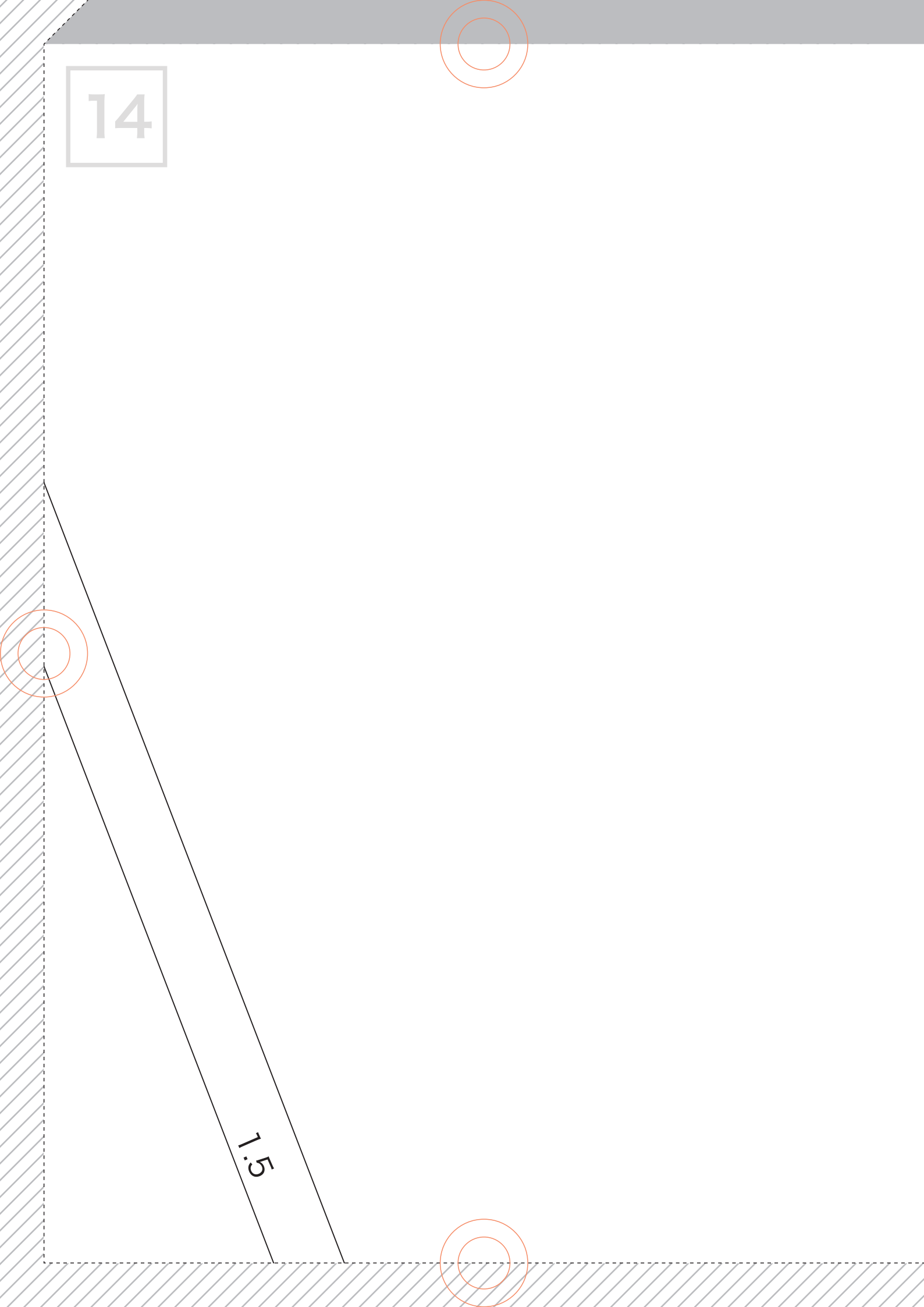

15

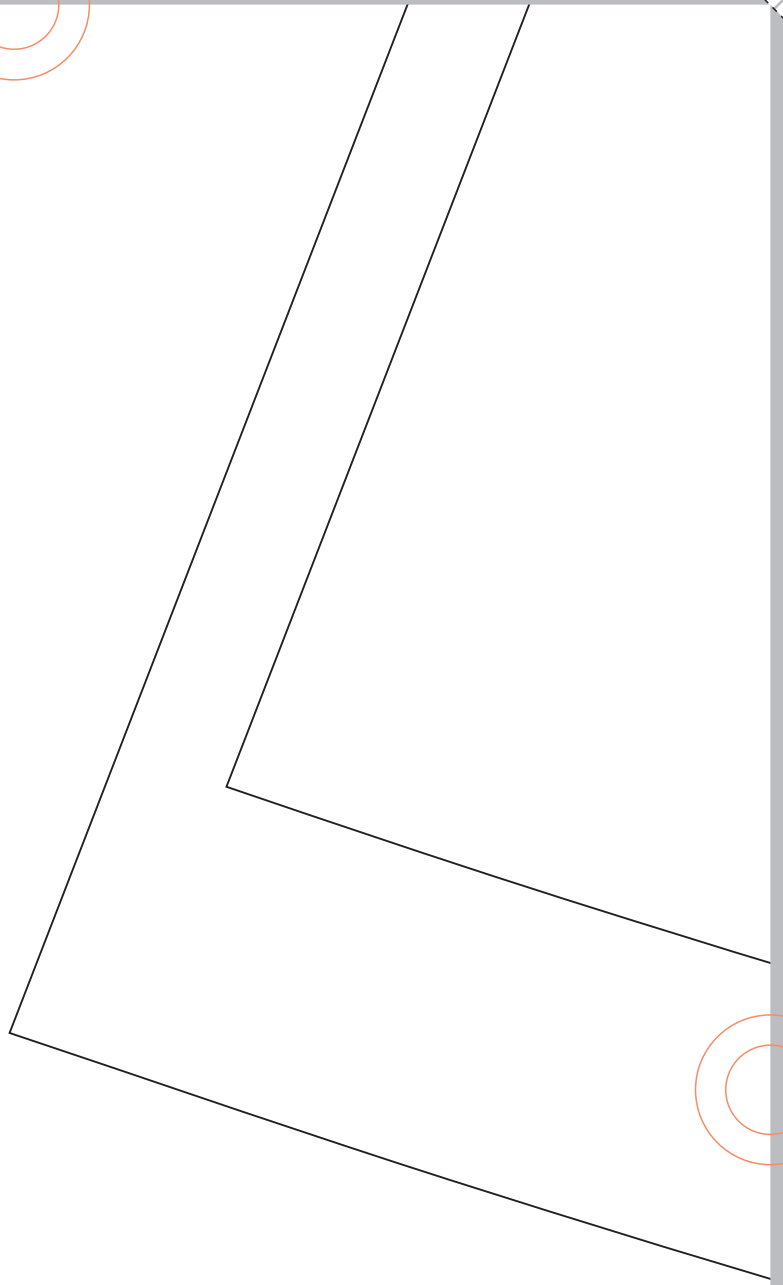

16

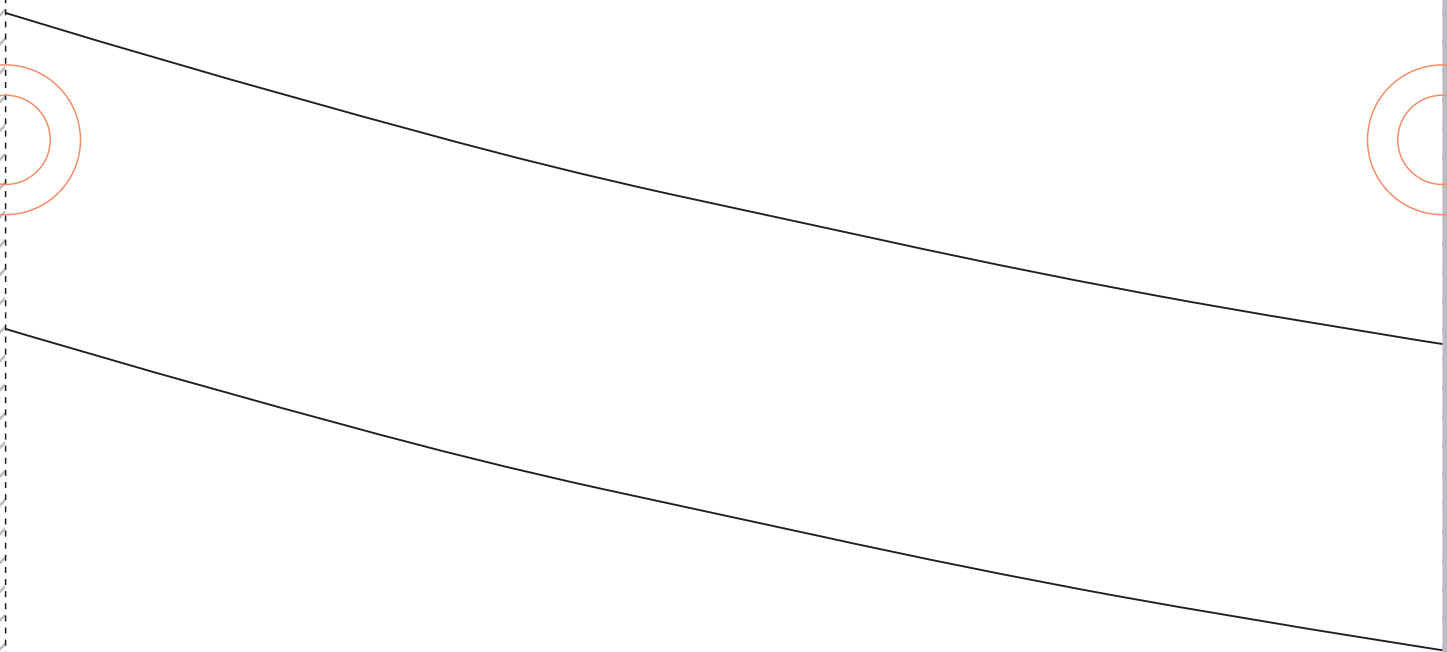
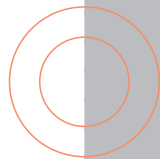
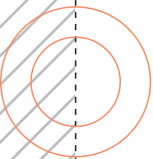
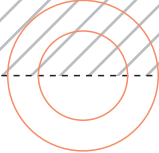

17

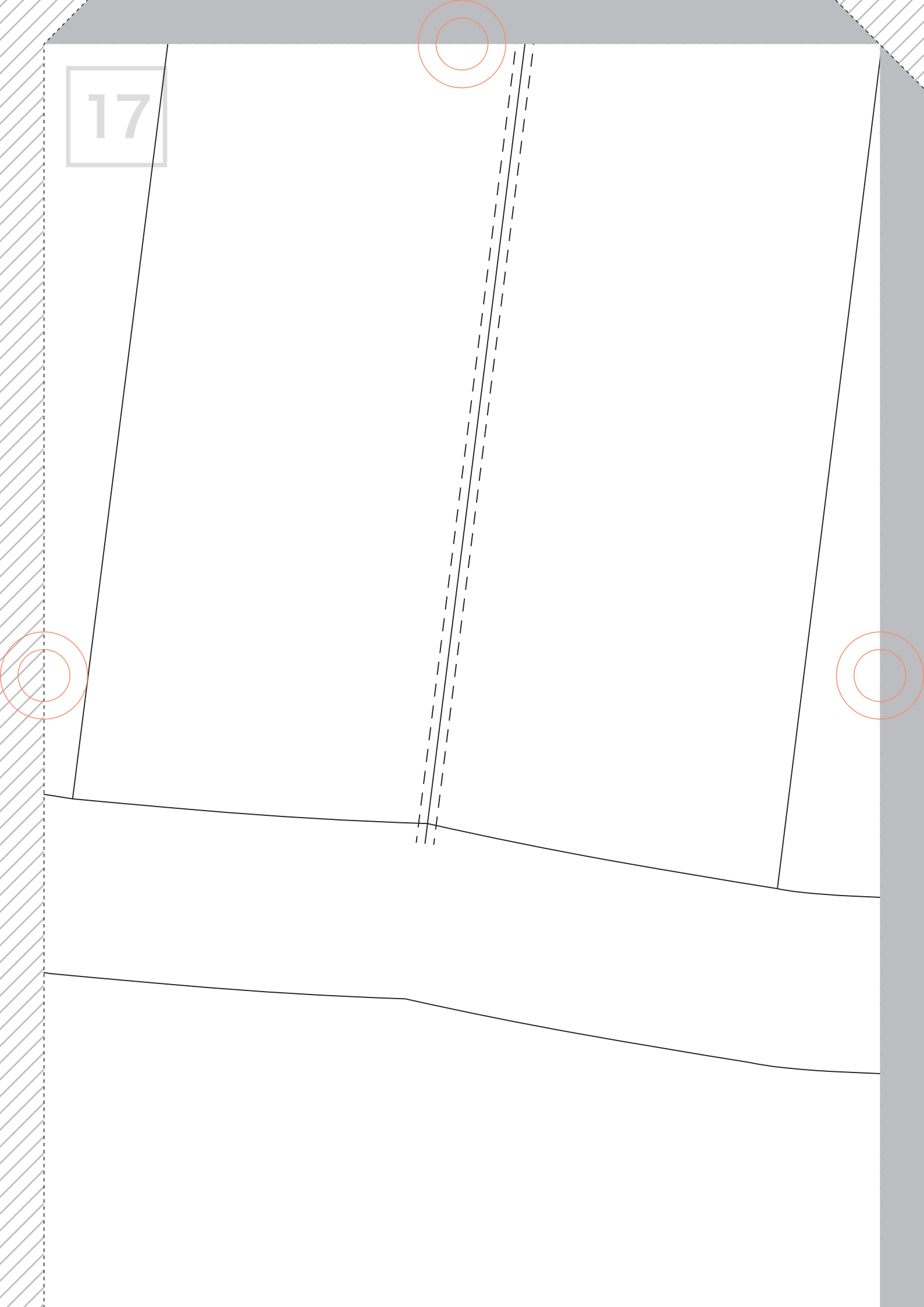
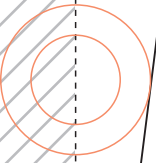
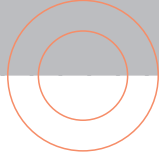

18

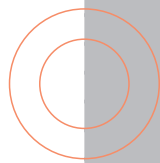
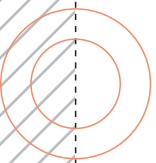
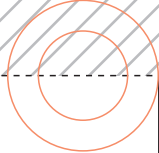

ロックしてまつる

19

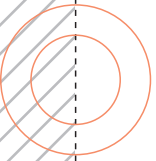
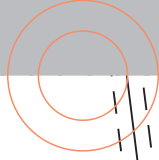

20

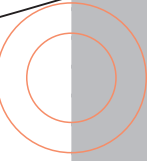
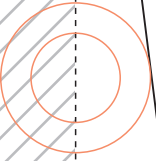
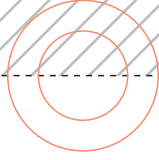

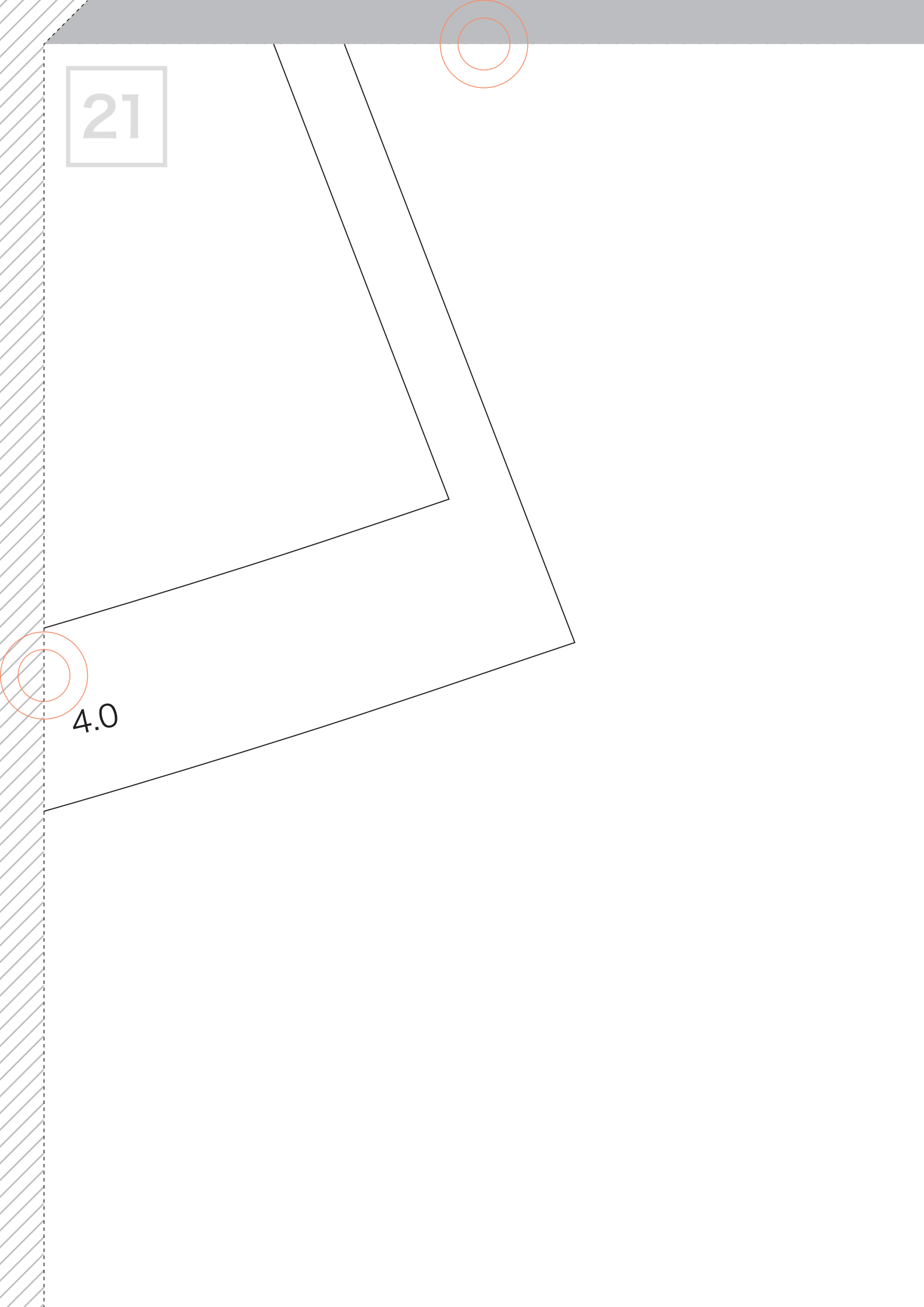

21

4.0

22

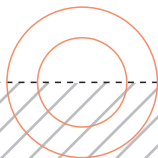

23

左脇

15mm伸び止めテープ

△ファスナー開き止まり

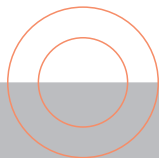
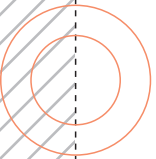

24

タック

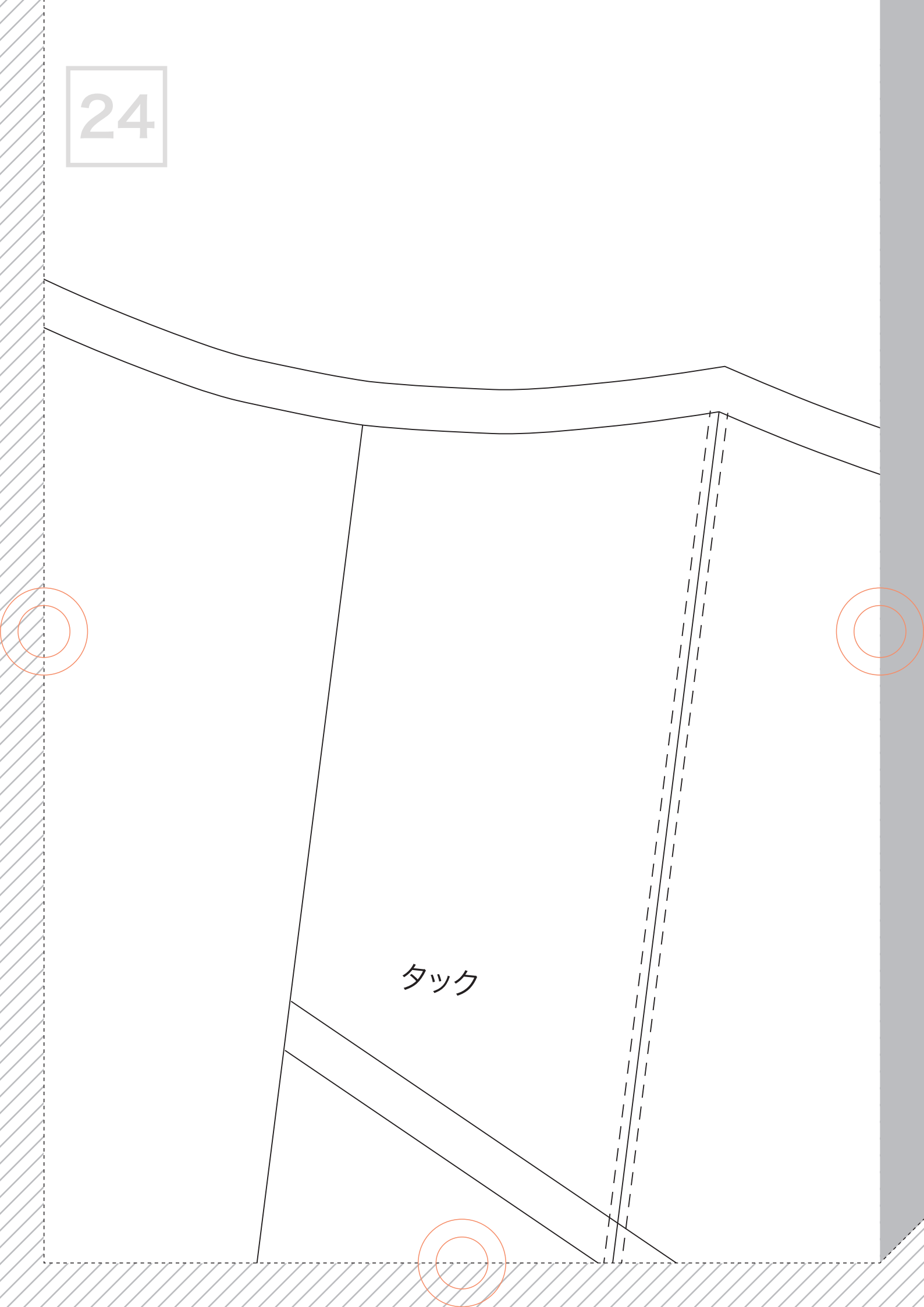

25

B. C

タック

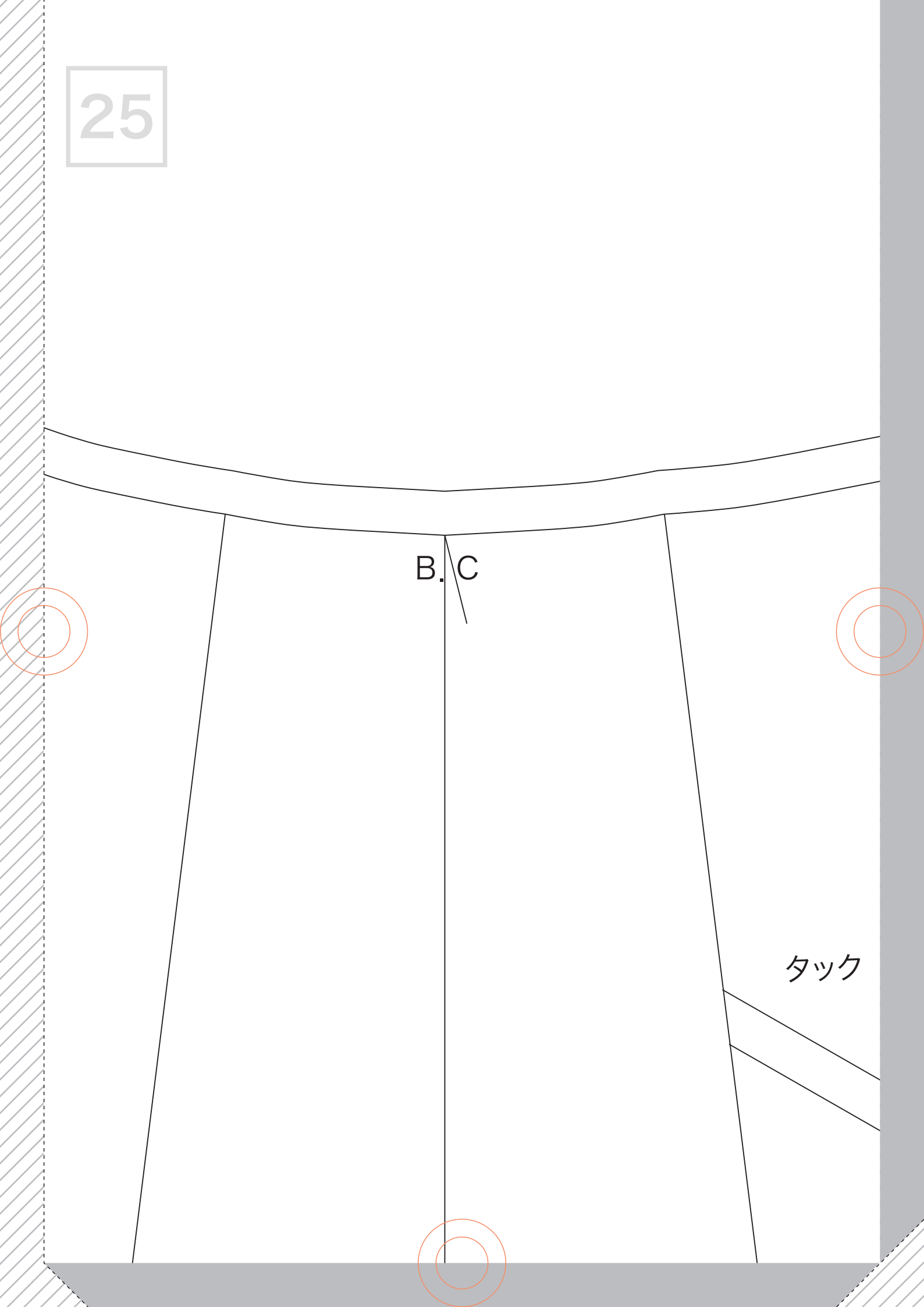

26

1.0

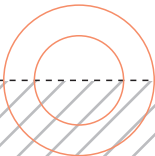
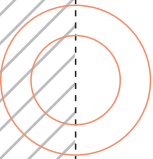

27

右脇

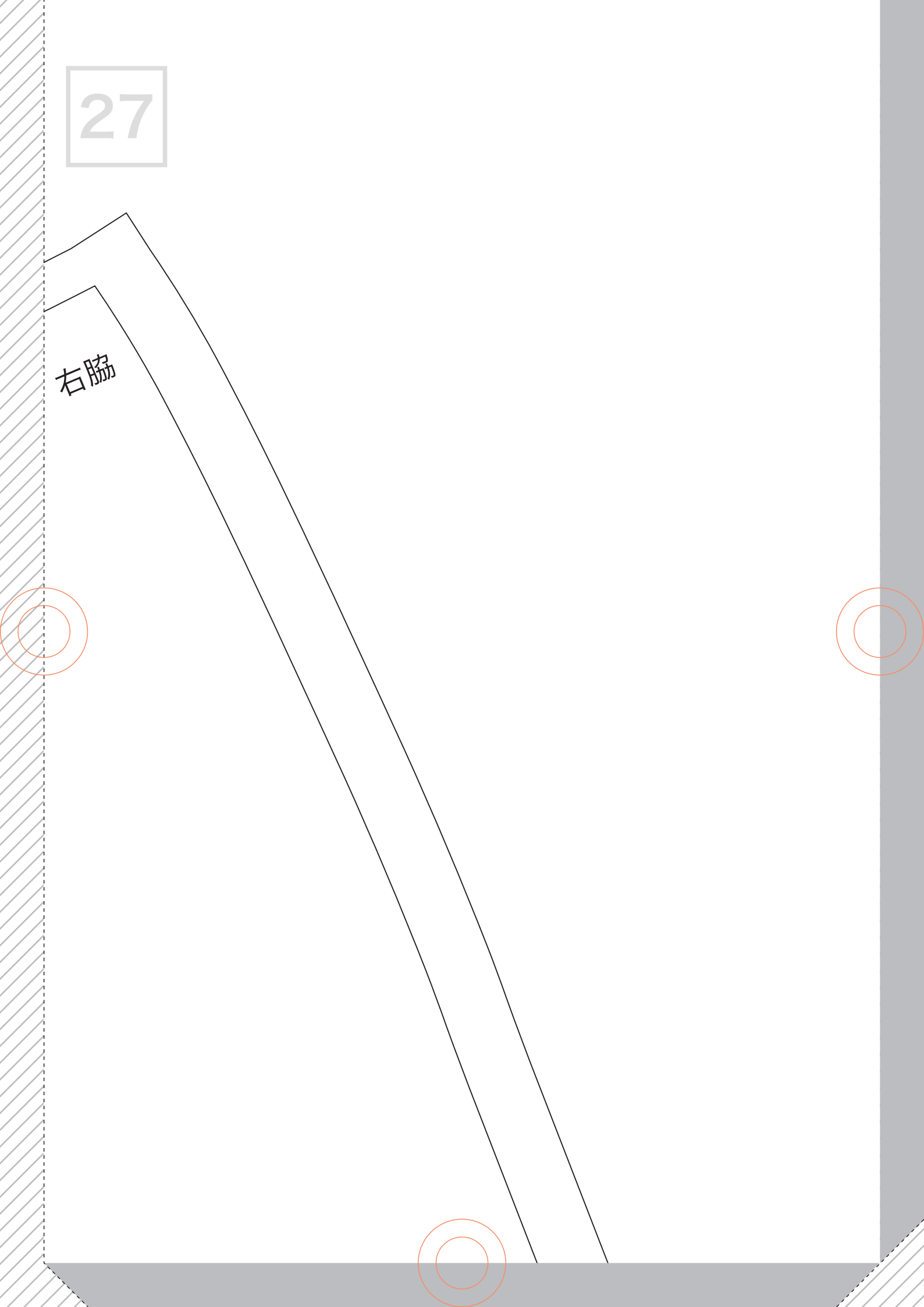

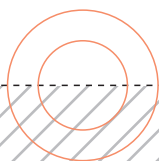
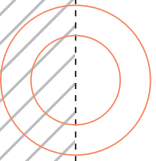

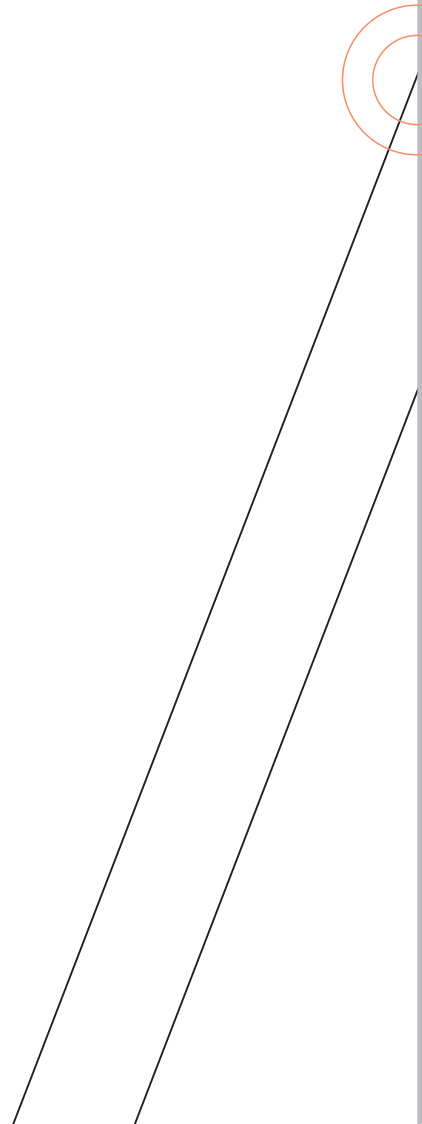
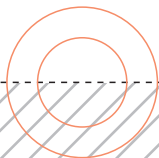
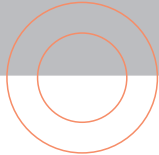

30

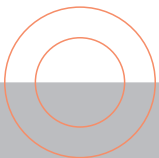
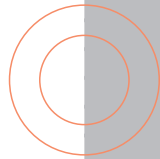
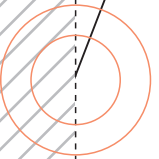
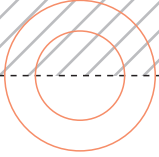

31

タックの方向

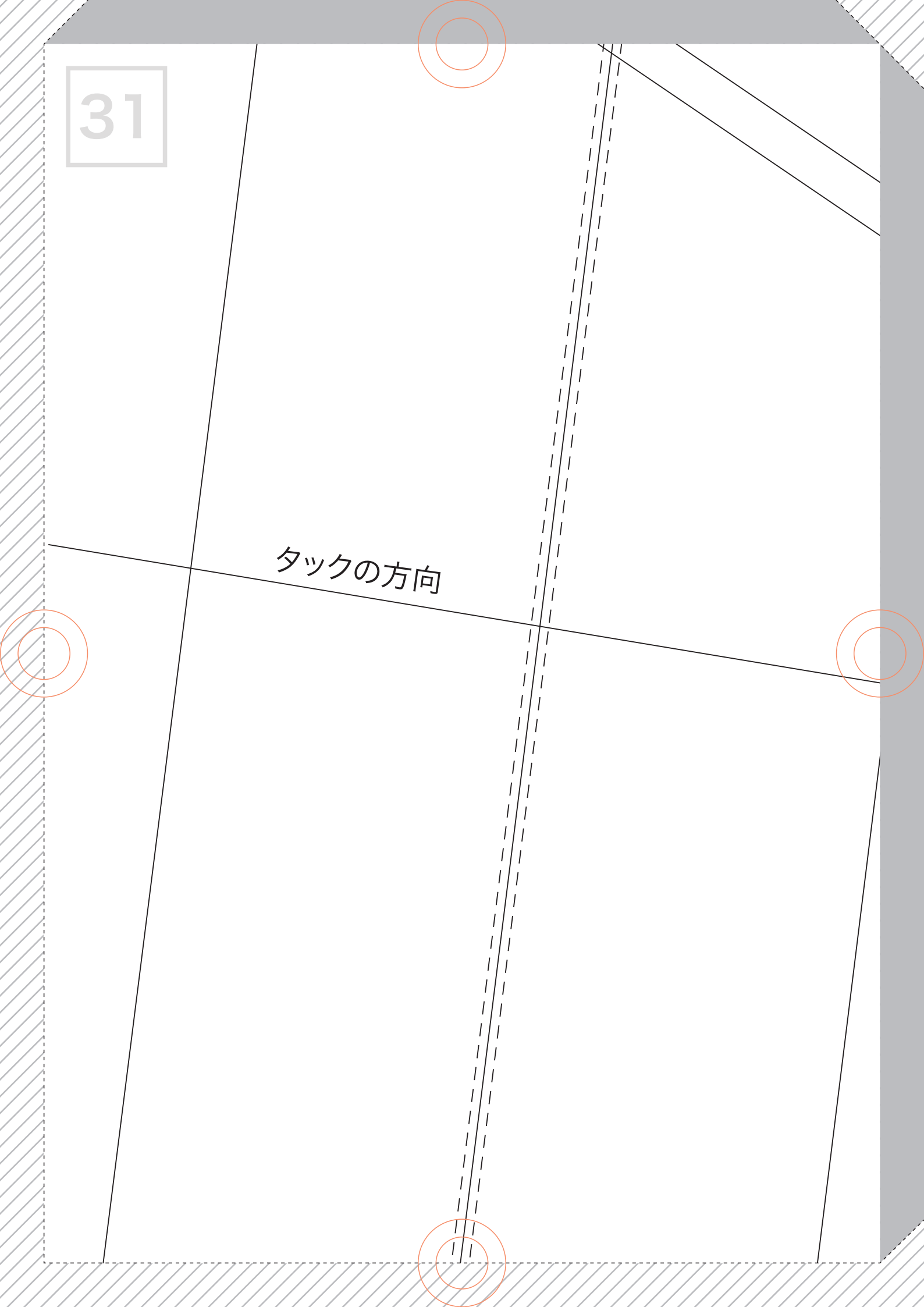

32

f a b f a b - 7

後スカート

size : 7

表 × 1 枚

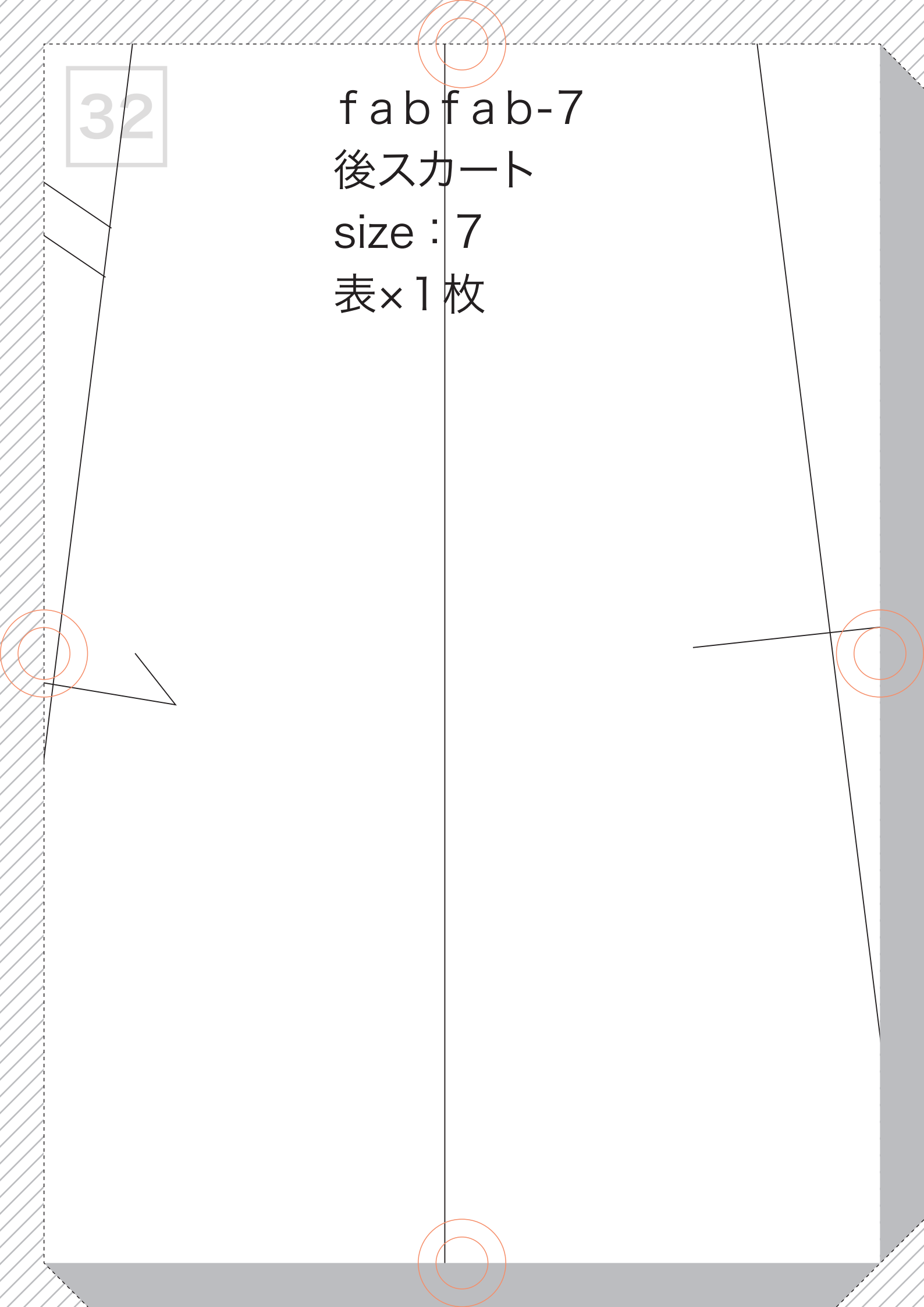

33

タックの方向

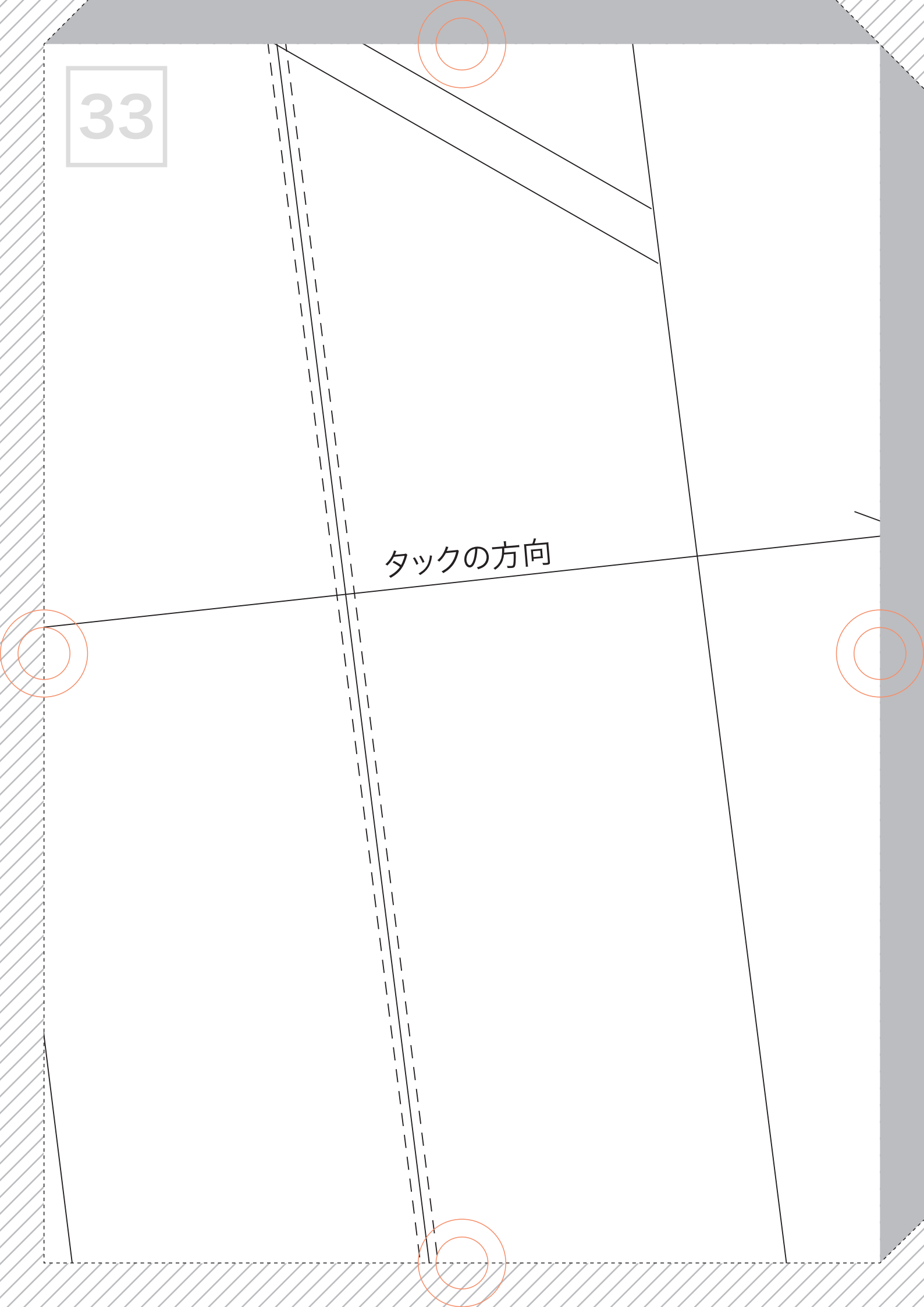

34

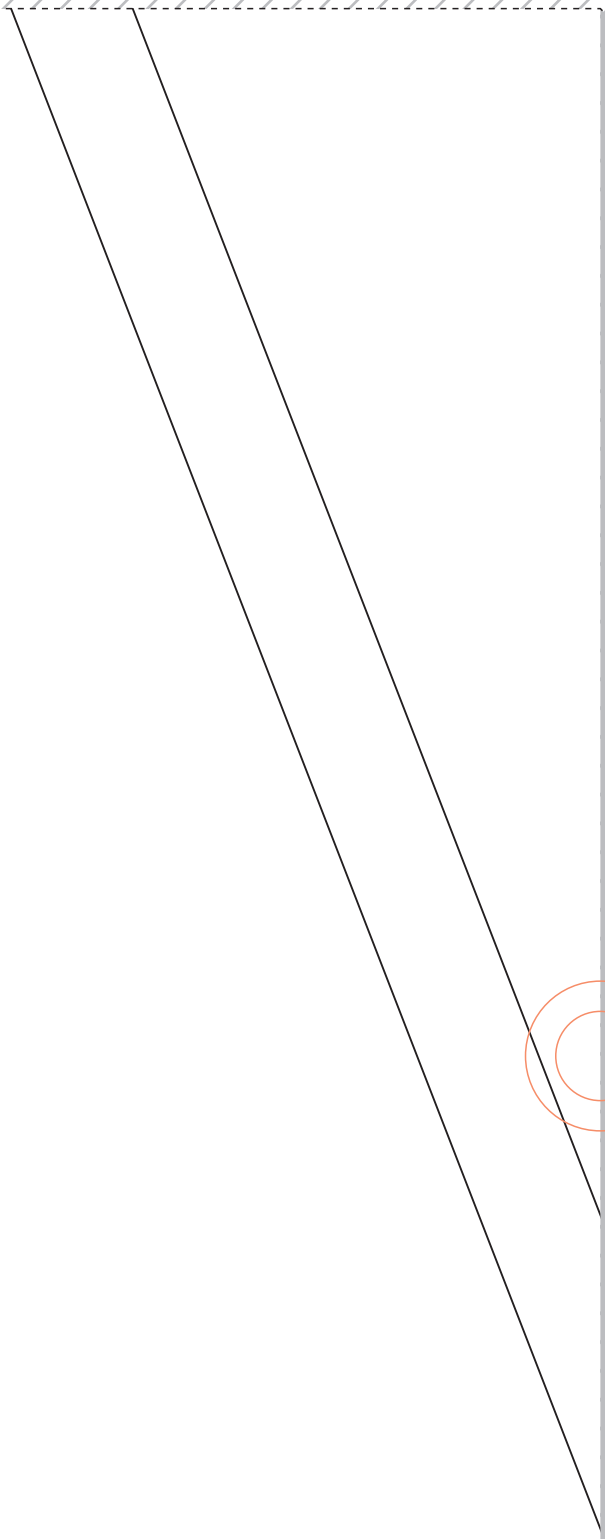
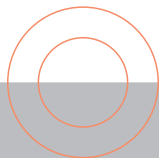
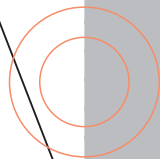
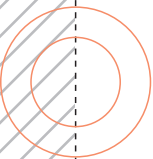
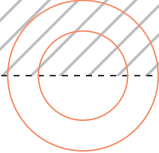

35

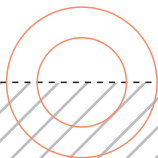
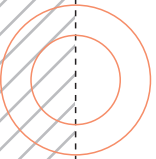
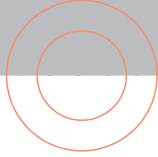

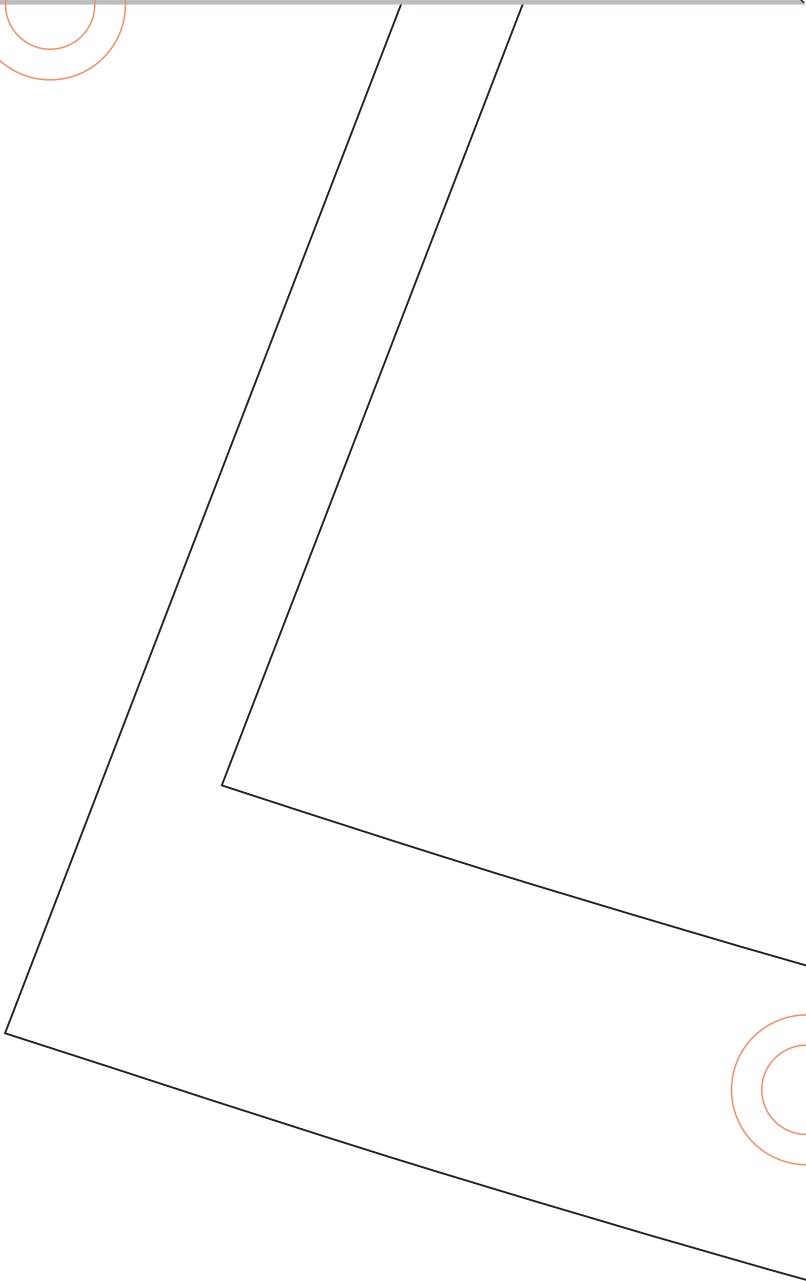
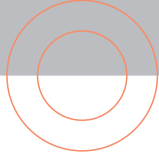

37

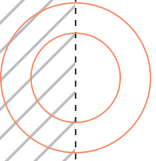
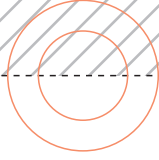

38

ひだ奥ステッチ0.2cm幅

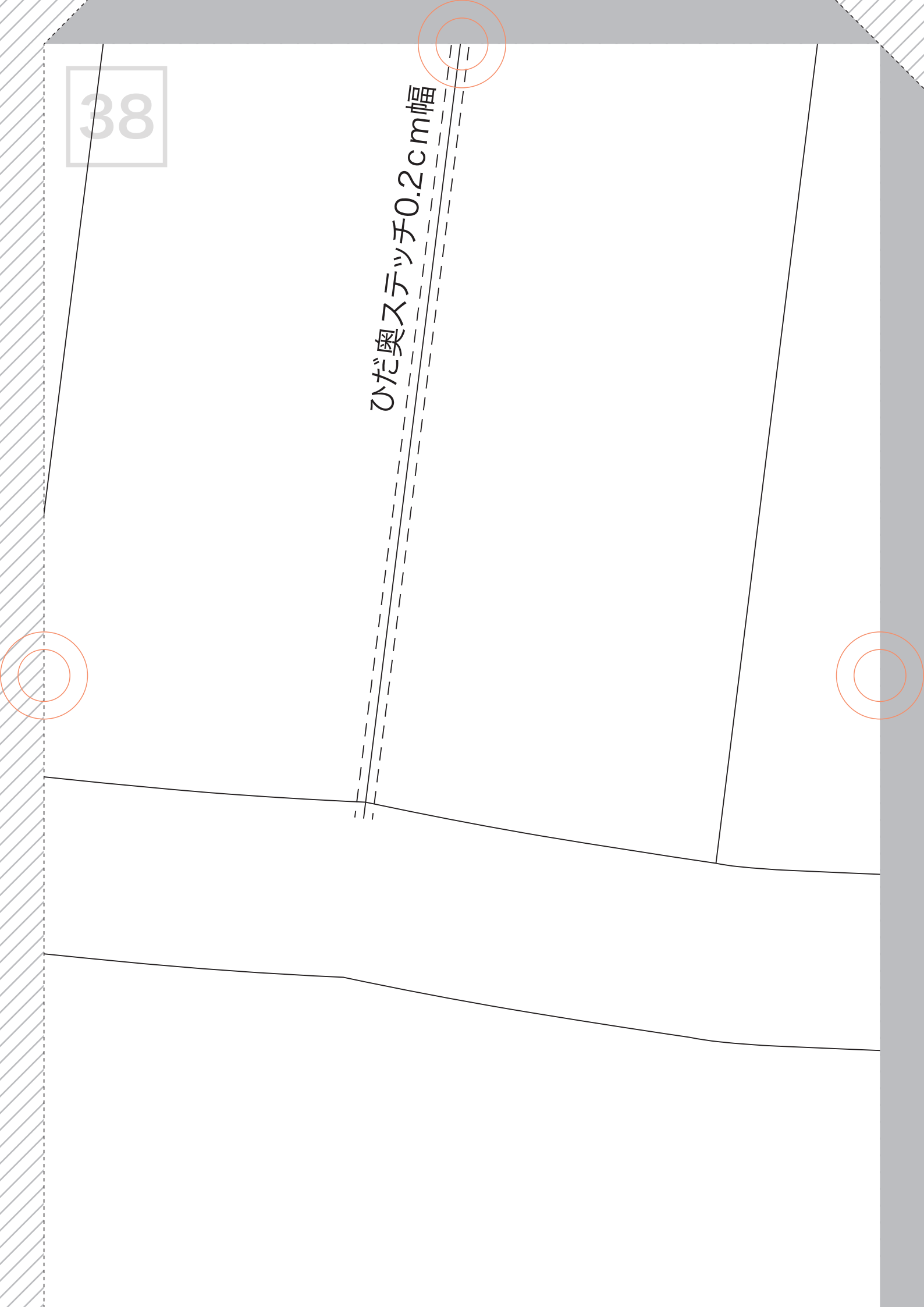

39

ロックしてまつる

40

ひだ奥ステッチ0.2cm幅

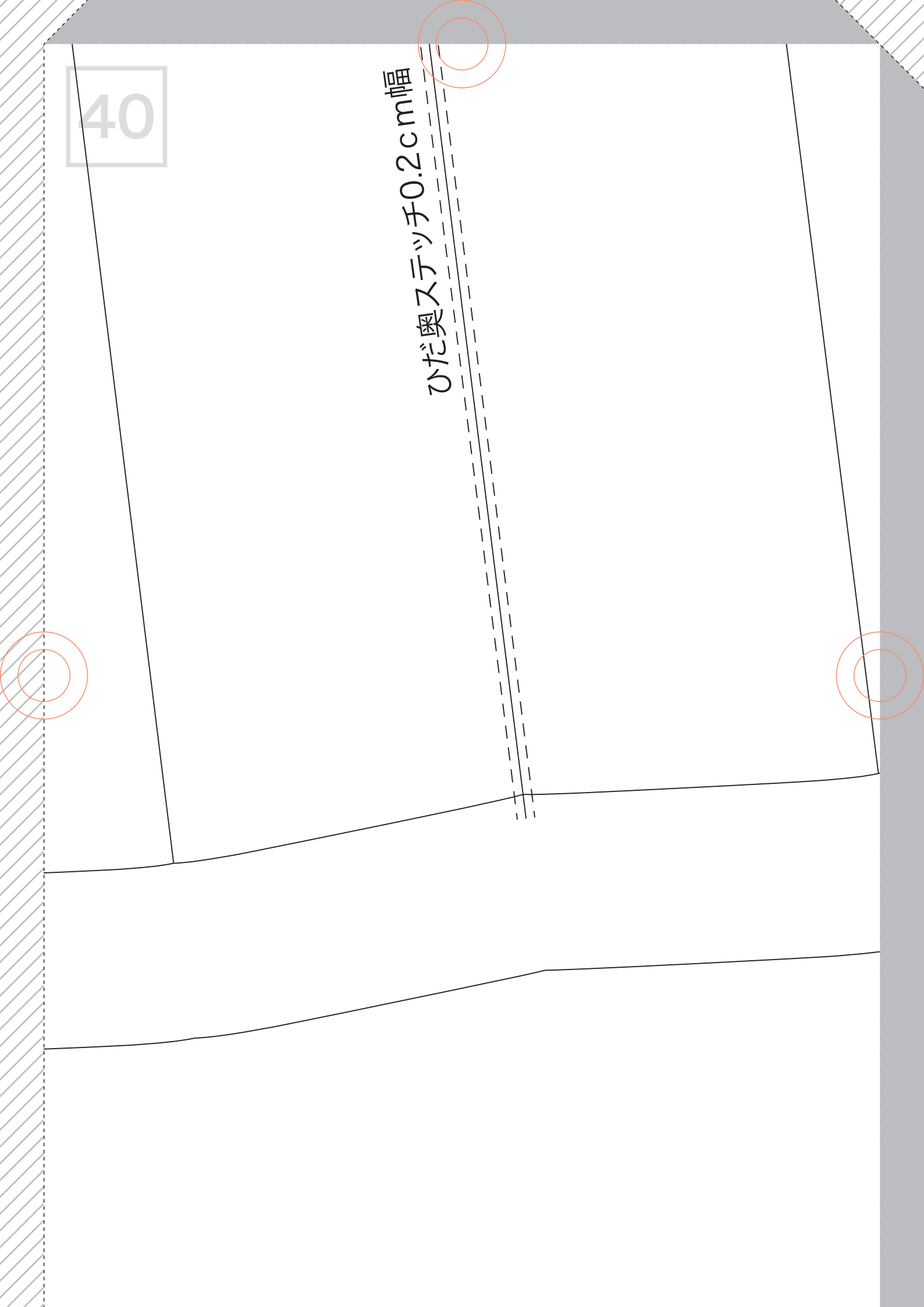

41

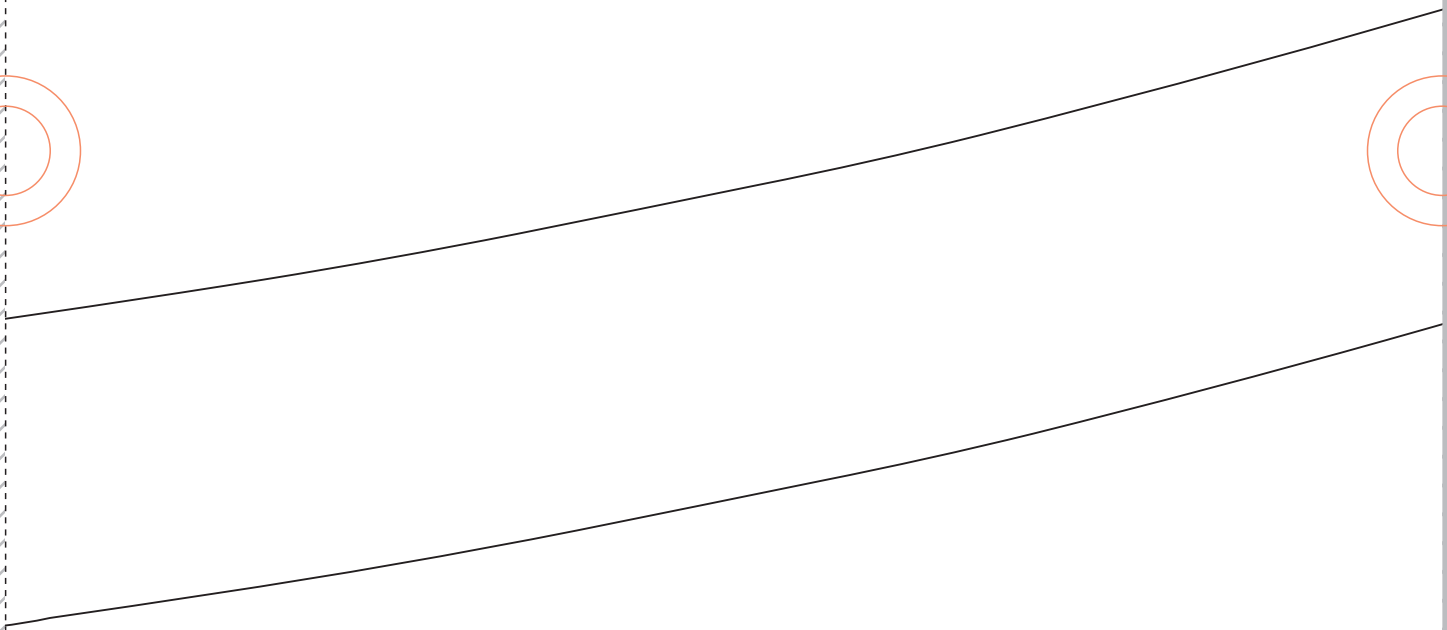
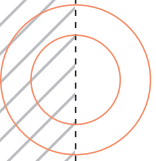
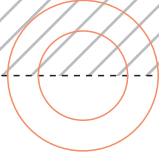

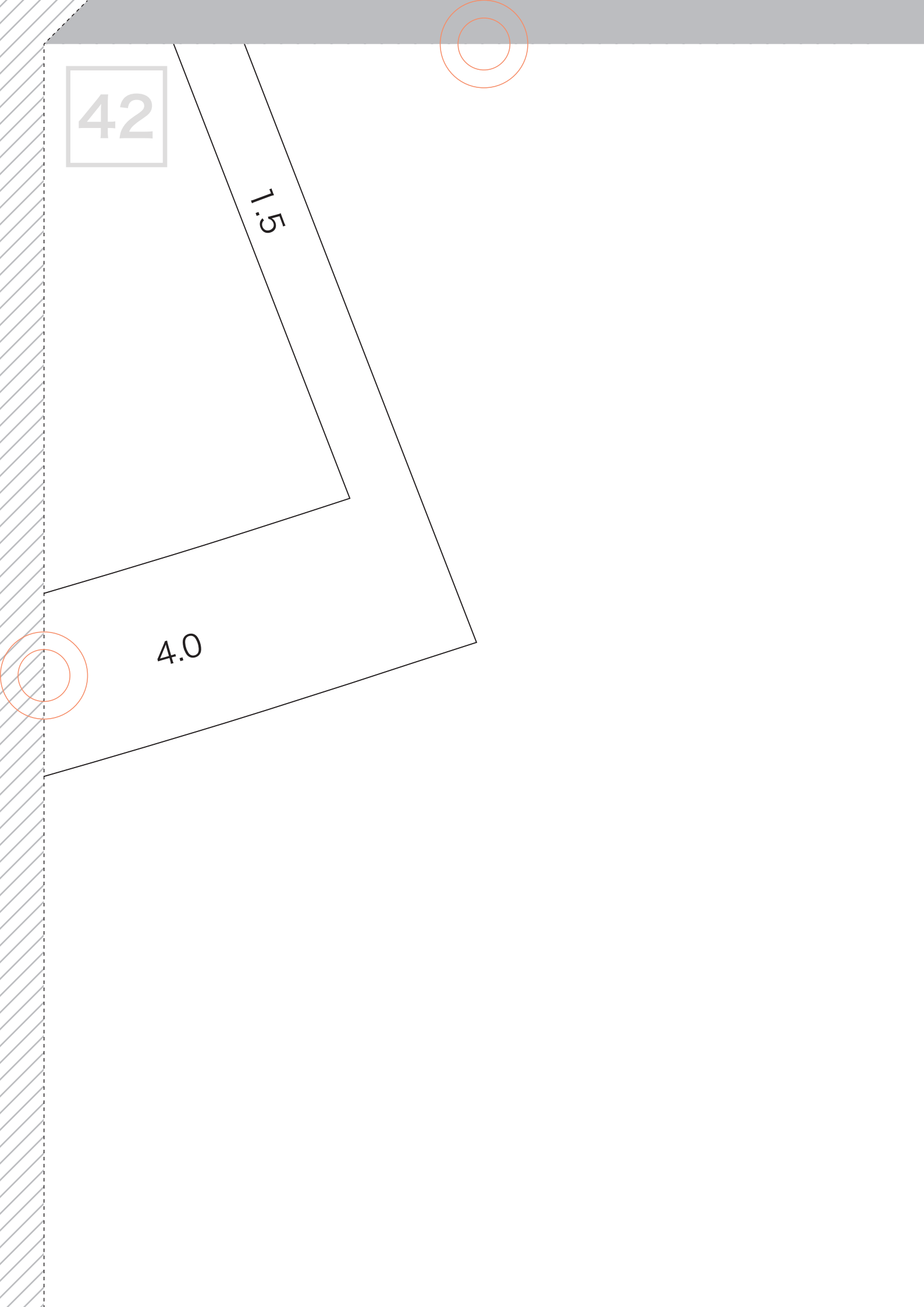

42

1.5

4.0

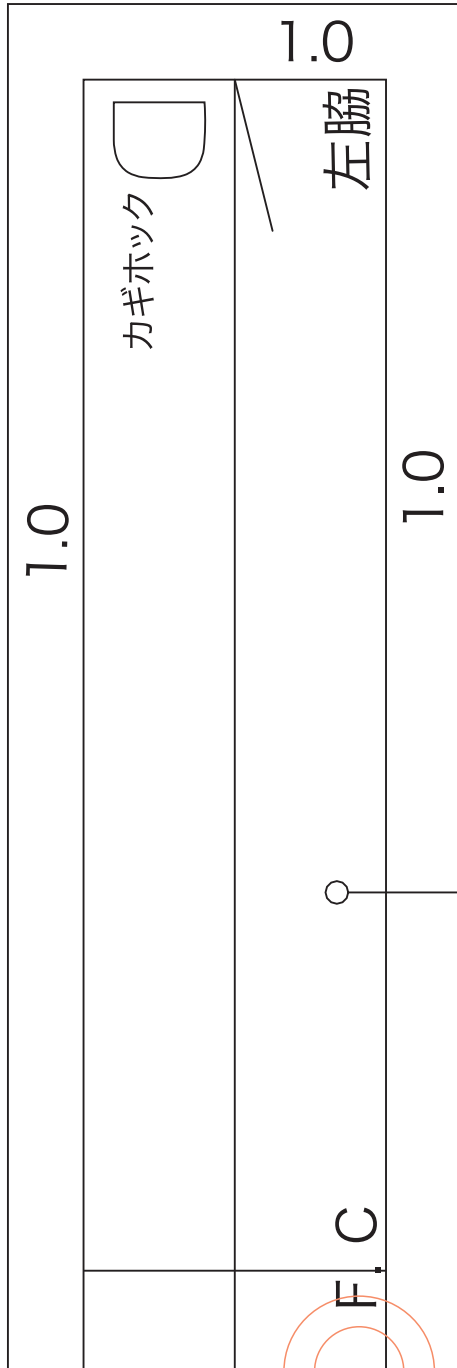

切り取る (斜線部はカット)

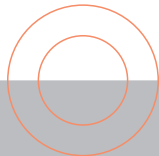
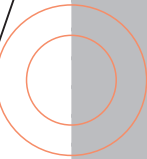
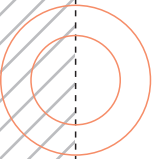

裏地

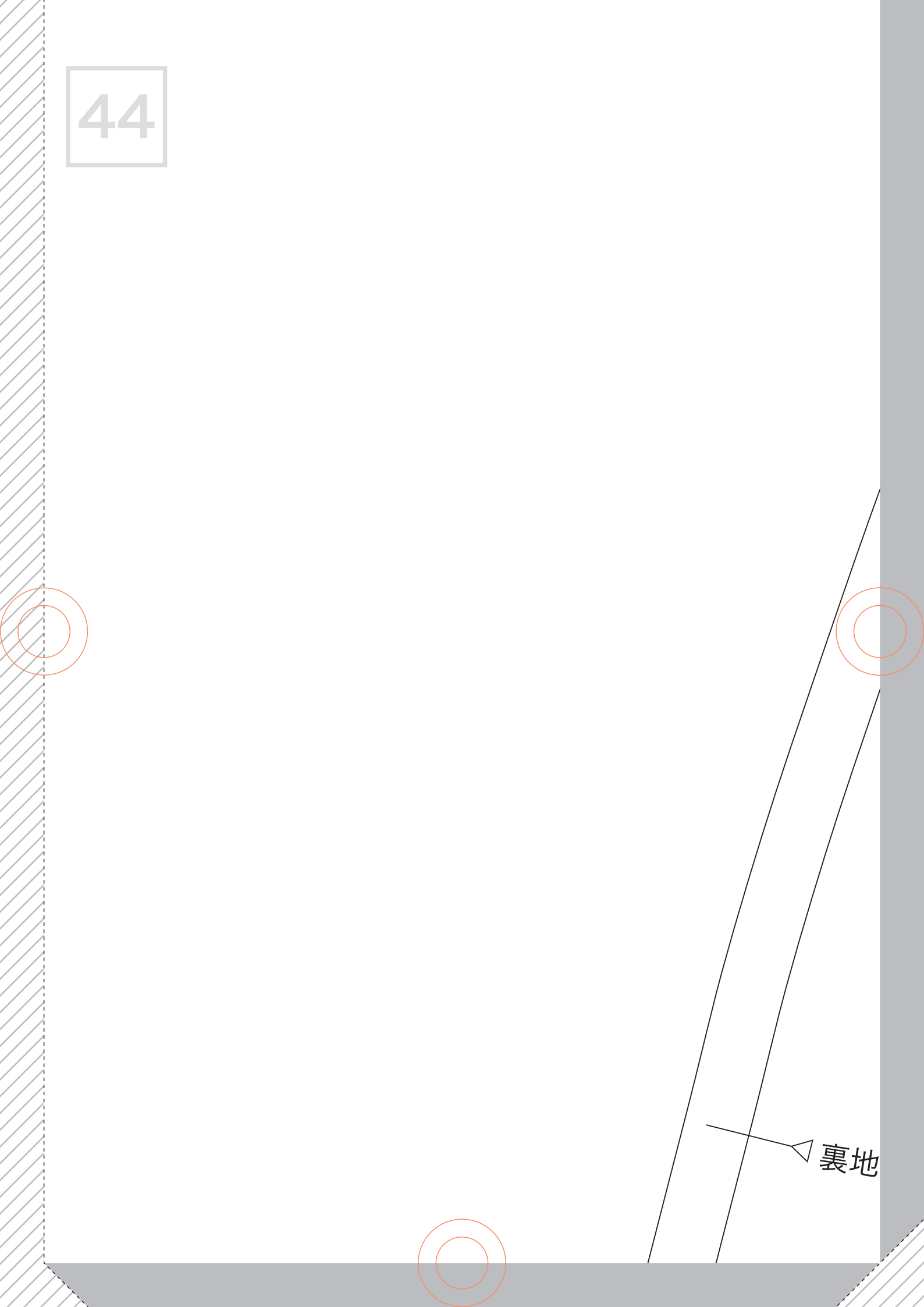

45

脇

1.0

タック

タックの方向

ファスナー止まり

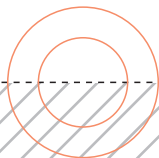
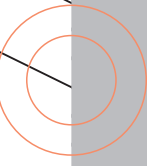
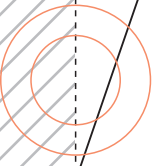

46

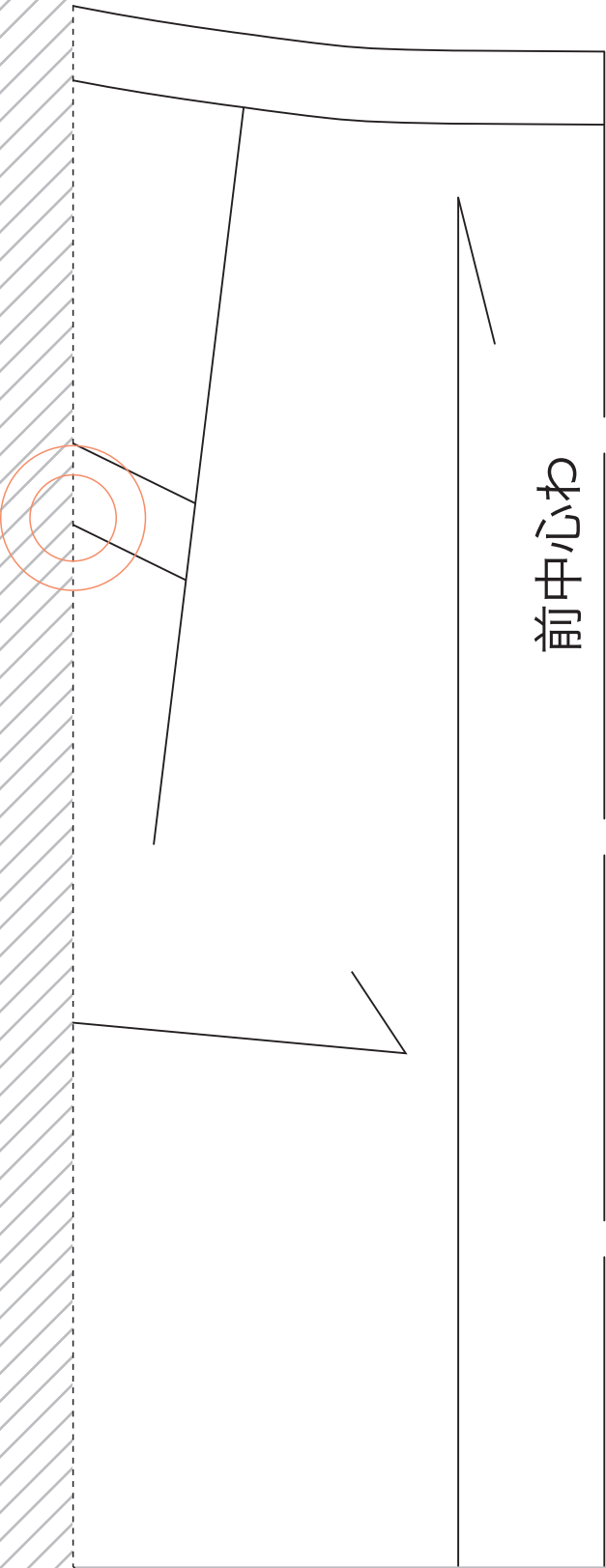

前中心わ

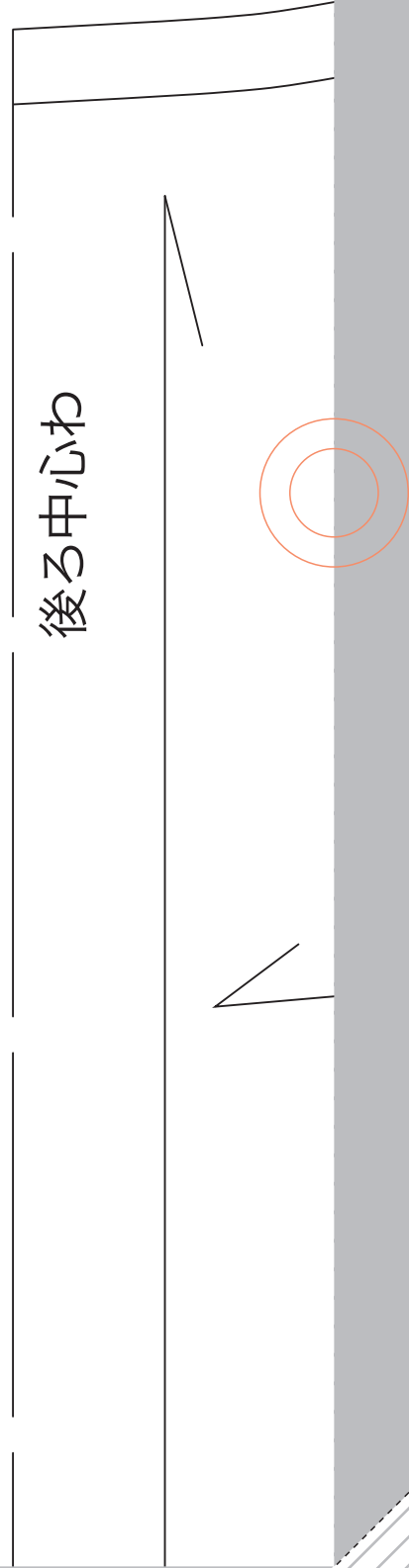

後ろ中心わ

47

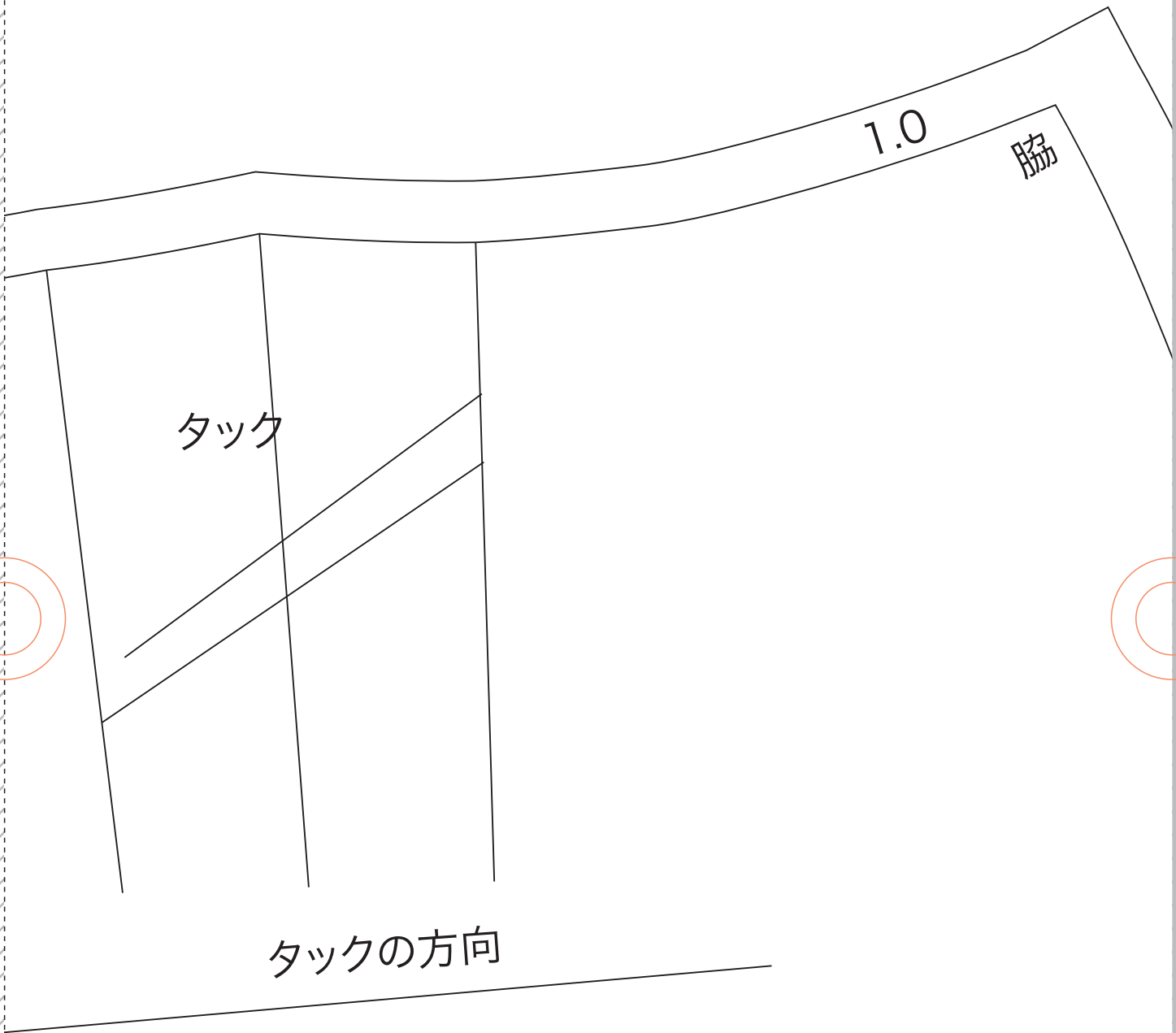

タック

1.0

脇

タックの方向

裏地ファス

48

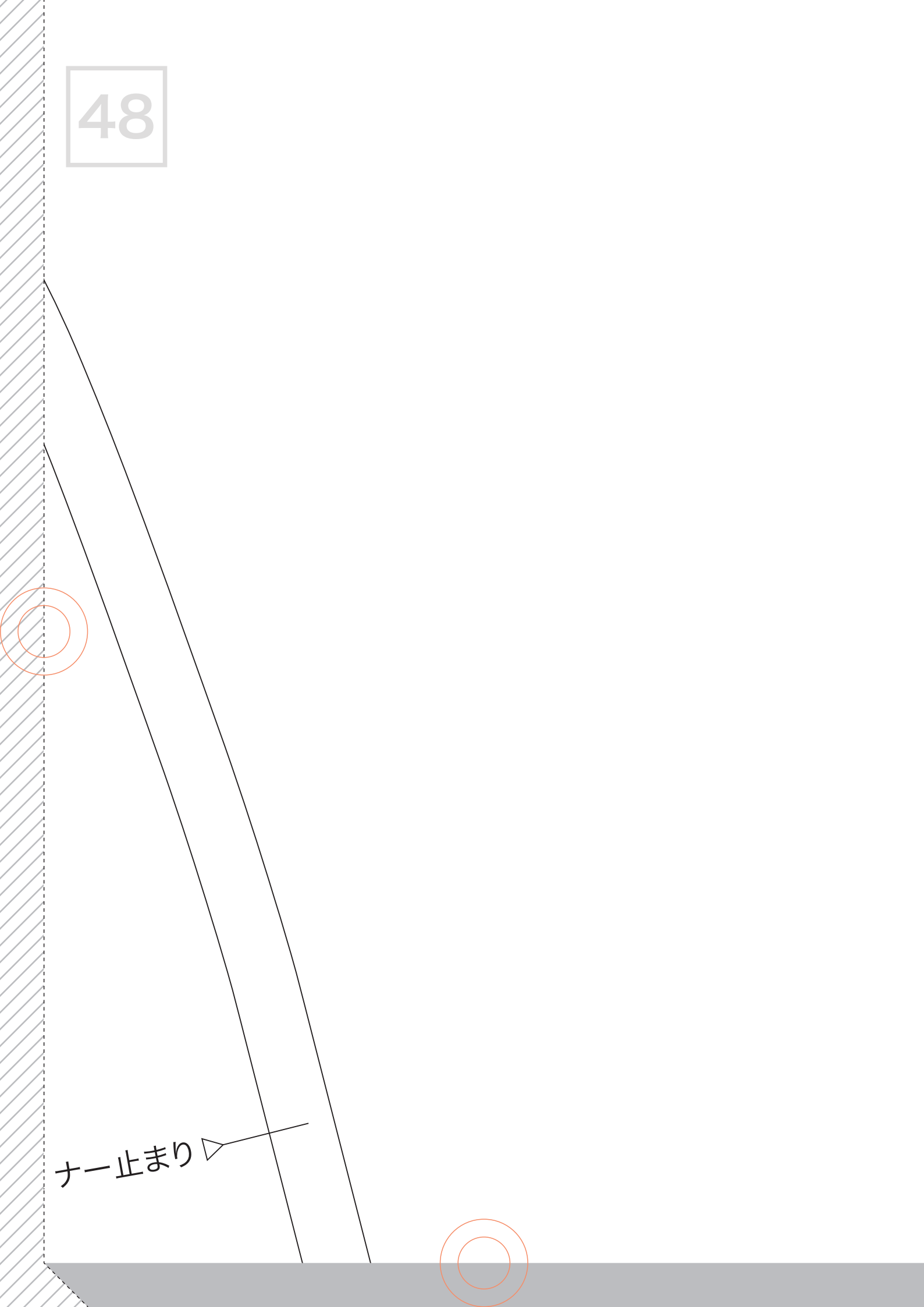

ナー止まり

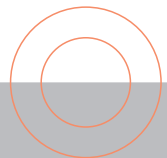

fabfab-7
ベルト

size: 7
表×1枚

2cm巾インベル
右脇

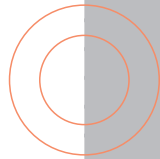
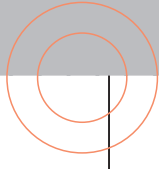
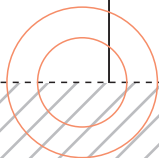

50

1.5

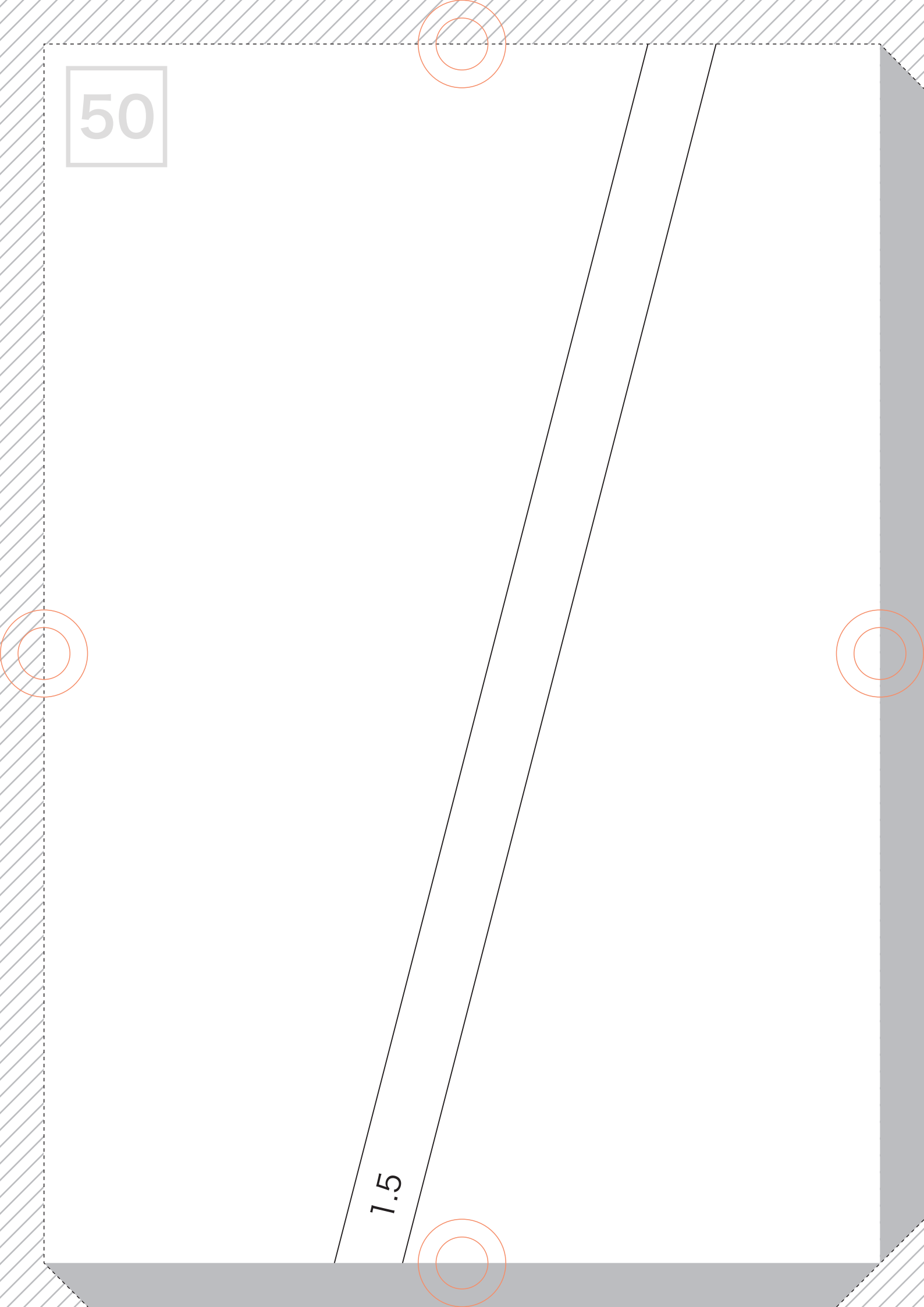

51

f a b f a b-7

裏前スカート

size : 7

裏×1枚

52

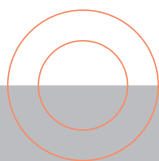
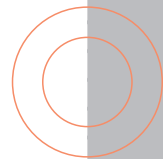
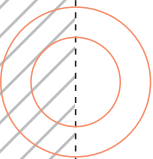
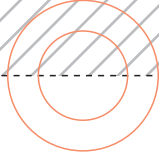

53

f a b f a b-7

裏後スカート

size : 7

裏×1枚

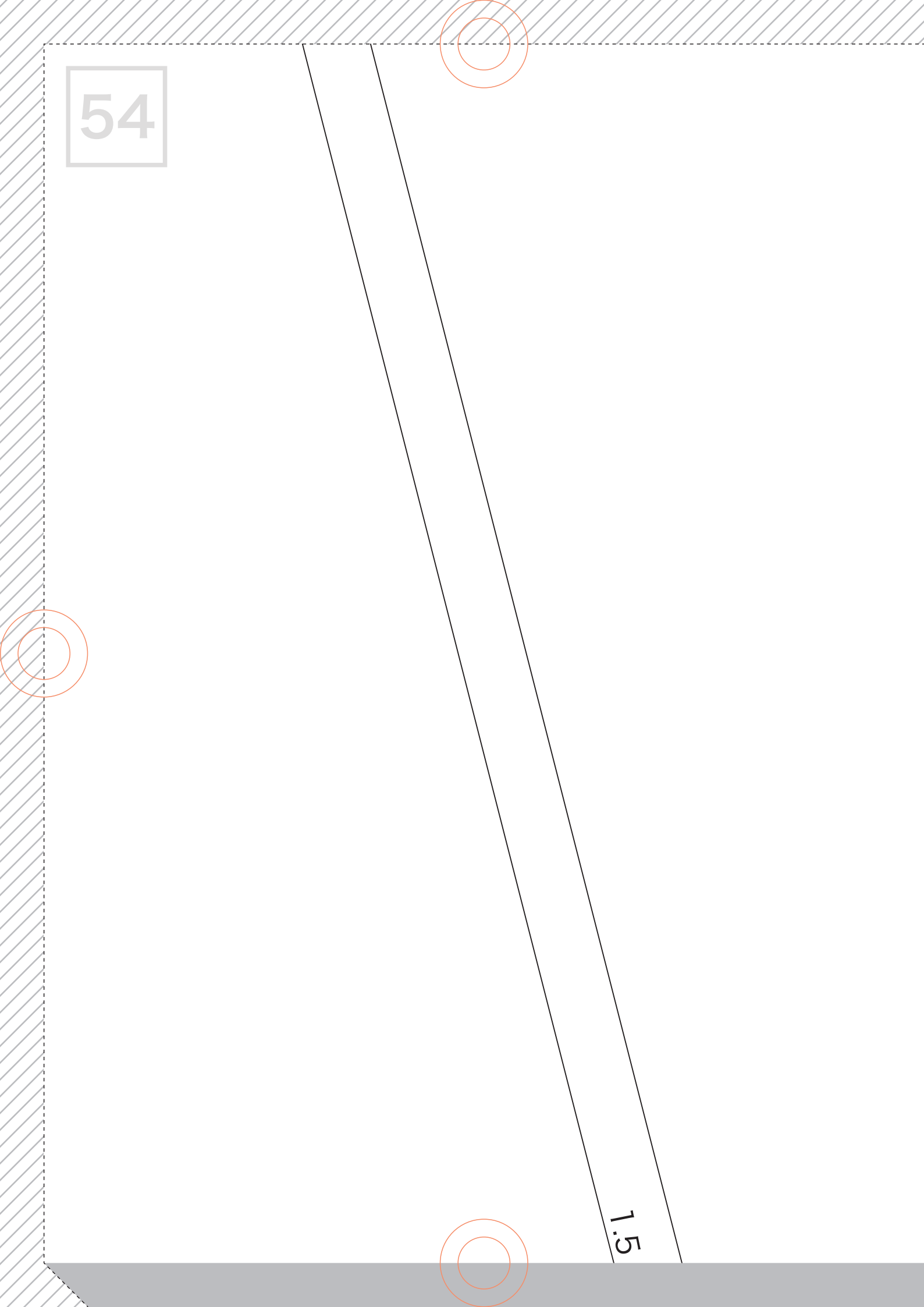

54

1.5

持ち出し		
カギホック <input type="checkbox"/>	左脇	B.C
1.0	○	



56

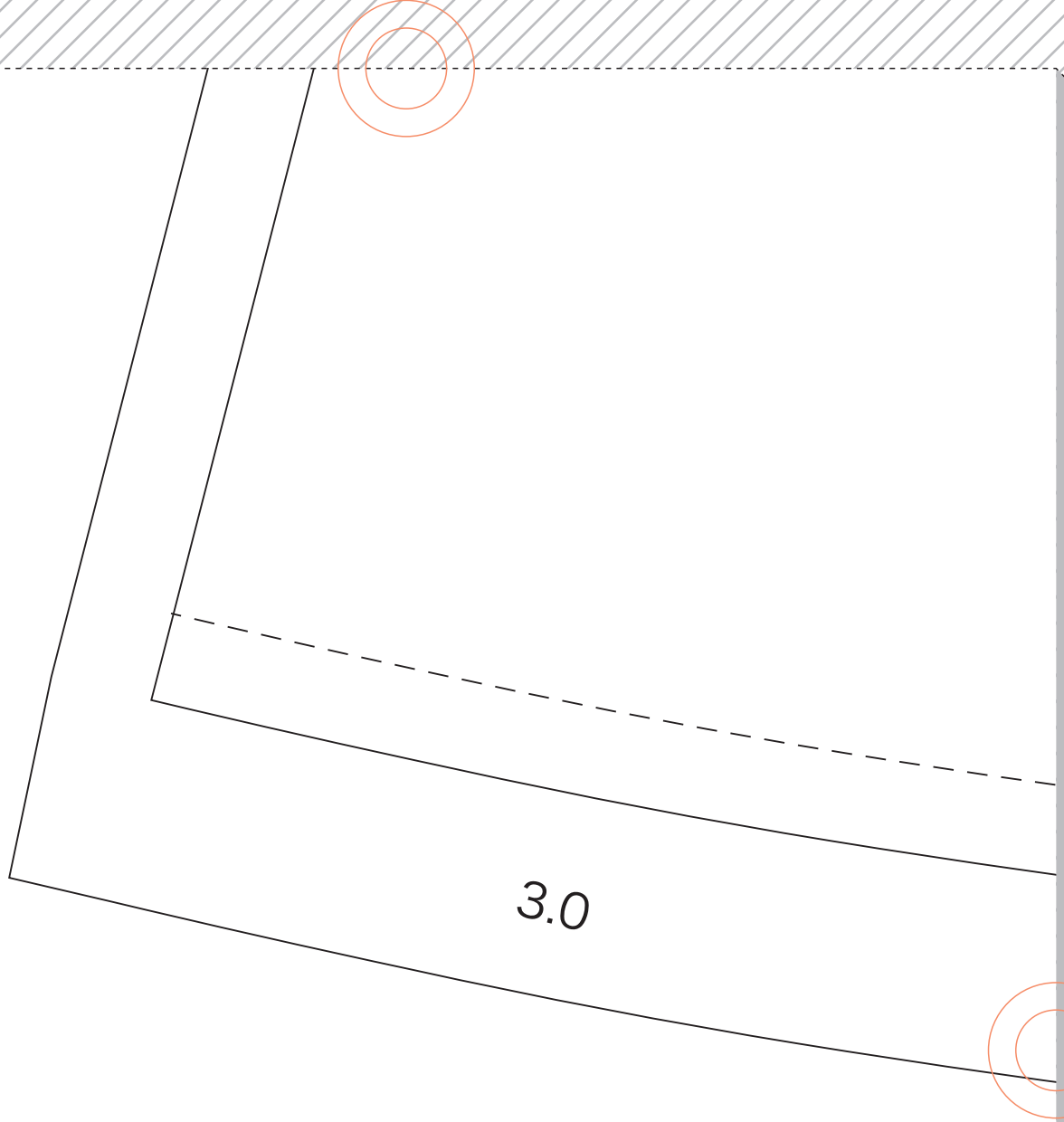

3.0

57

1.5cm幅三つ折りステッチ

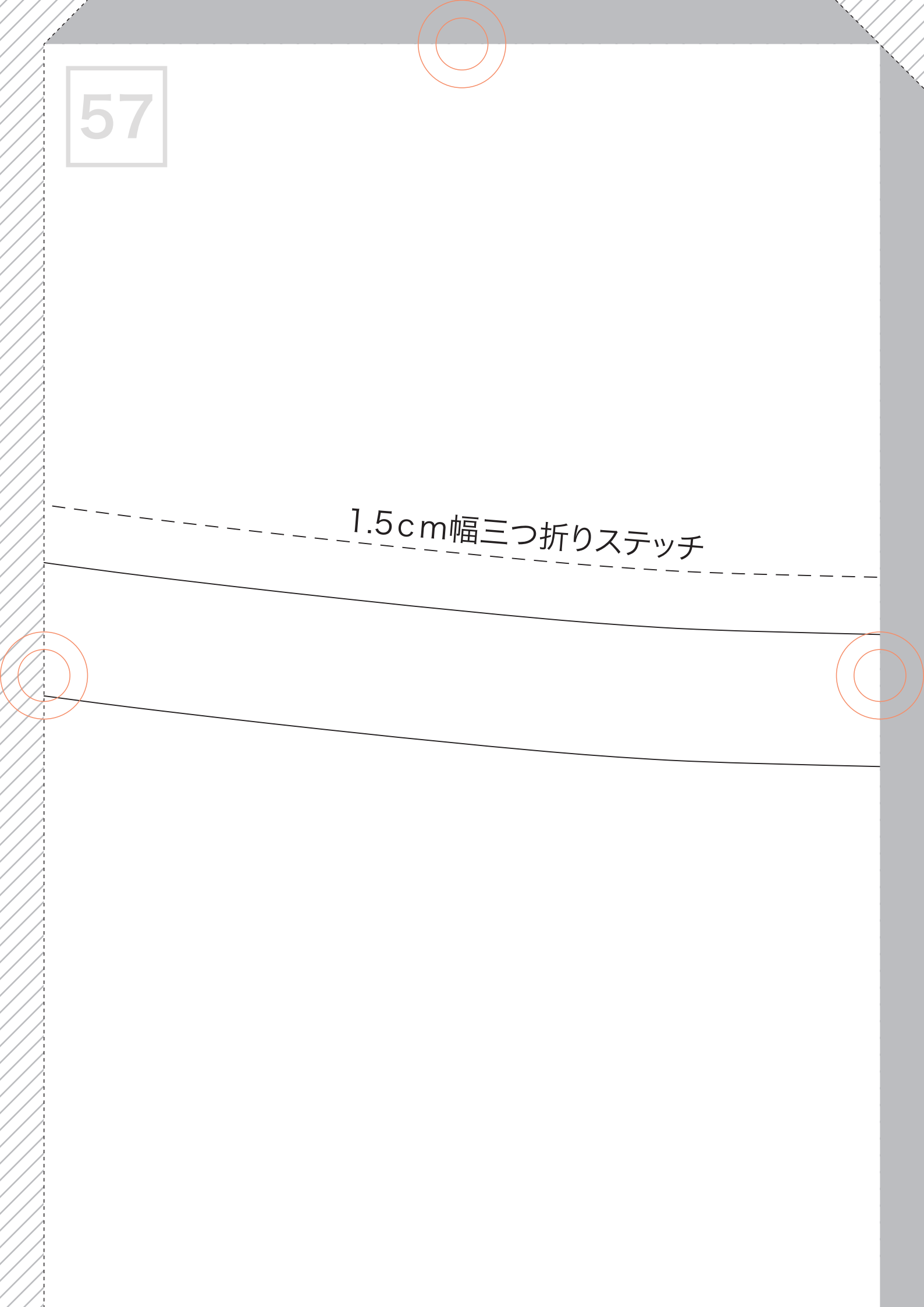

58

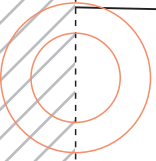
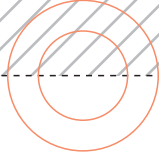

59

1.5cm幅三つ折りステッチ



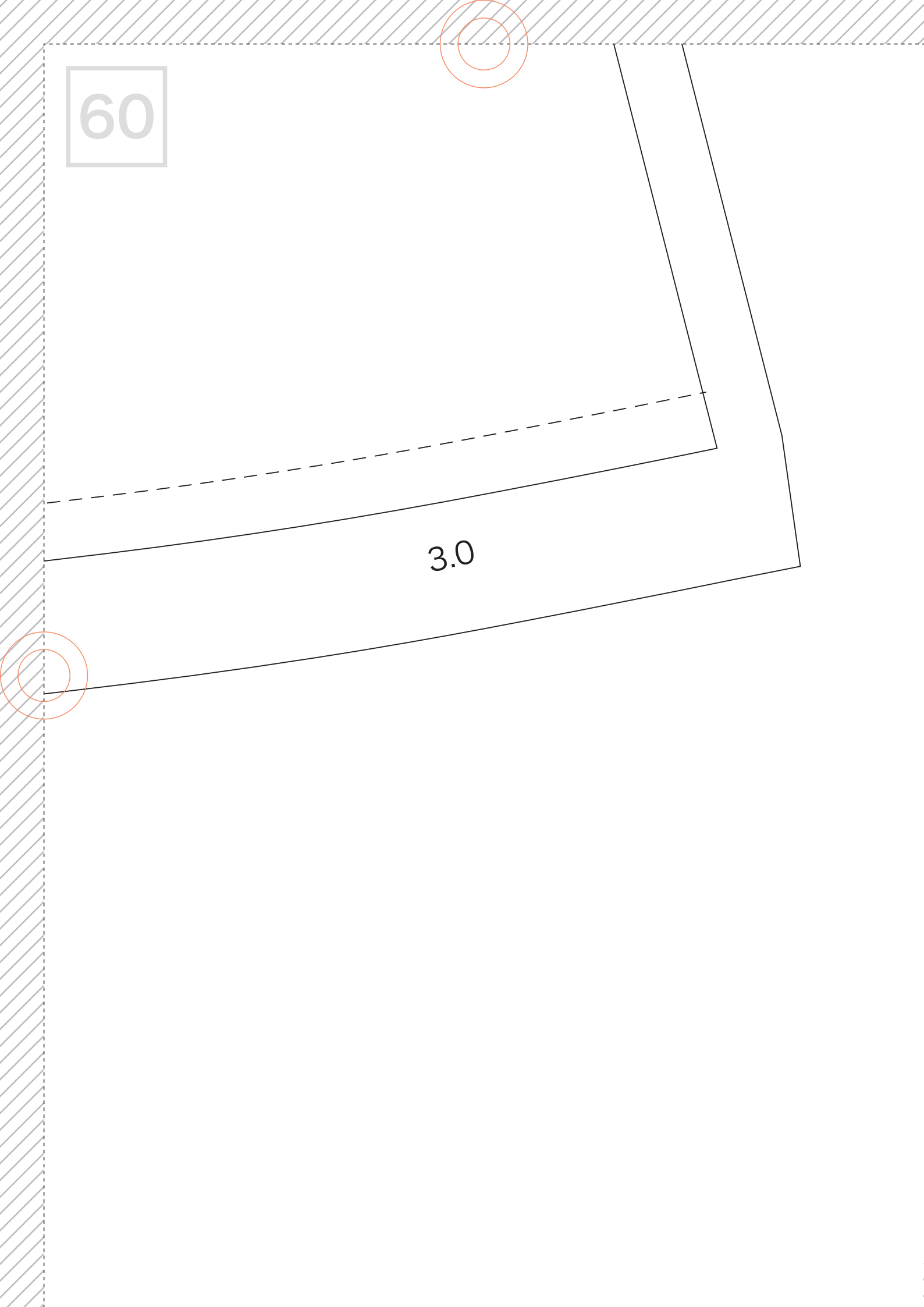

60

3.0