



introduction はじめに

パターンは A4 サイズ 60 枚に分割されています。
印刷後、右図のようにつなぎ合わせてください。

! 印刷時の注意

印刷設定では、「ページの拡大や縮小」を選択せず
必ず、「実際のサイズ」(原寸) で印刷してください。

how to make パターンのつくりかた

STEP1 斜線部分  は切り取り、灰色部分  は残してのりしろにします。
(斜線と灰色を間違えないように注意)

STEP2 各用紙の番号を確認し、 の位置を合わせて、
のりづけします。
(水のりは用紙が波打ちます。スティック糊などをお使いください)

STEP3 それぞれのパーツをハサミで切り出します。

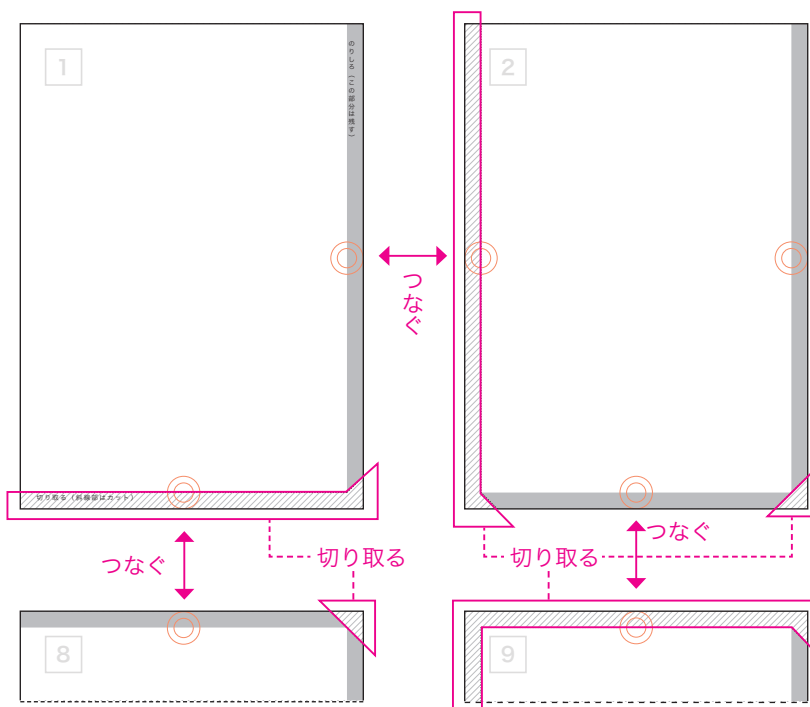
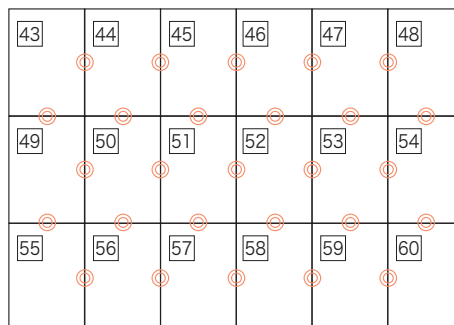
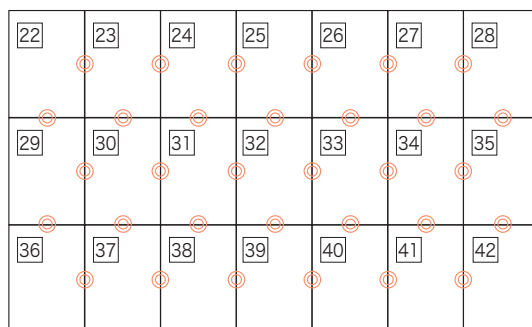
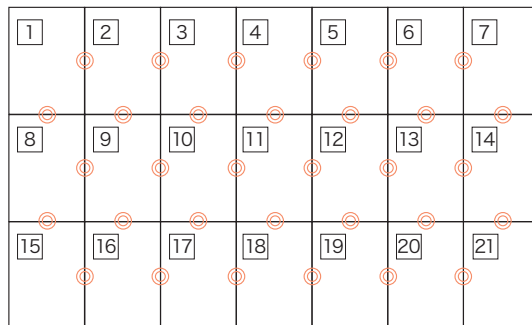

1

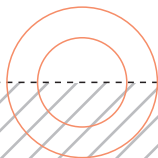

2

右脇

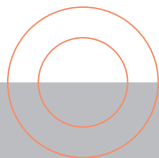
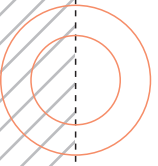

3

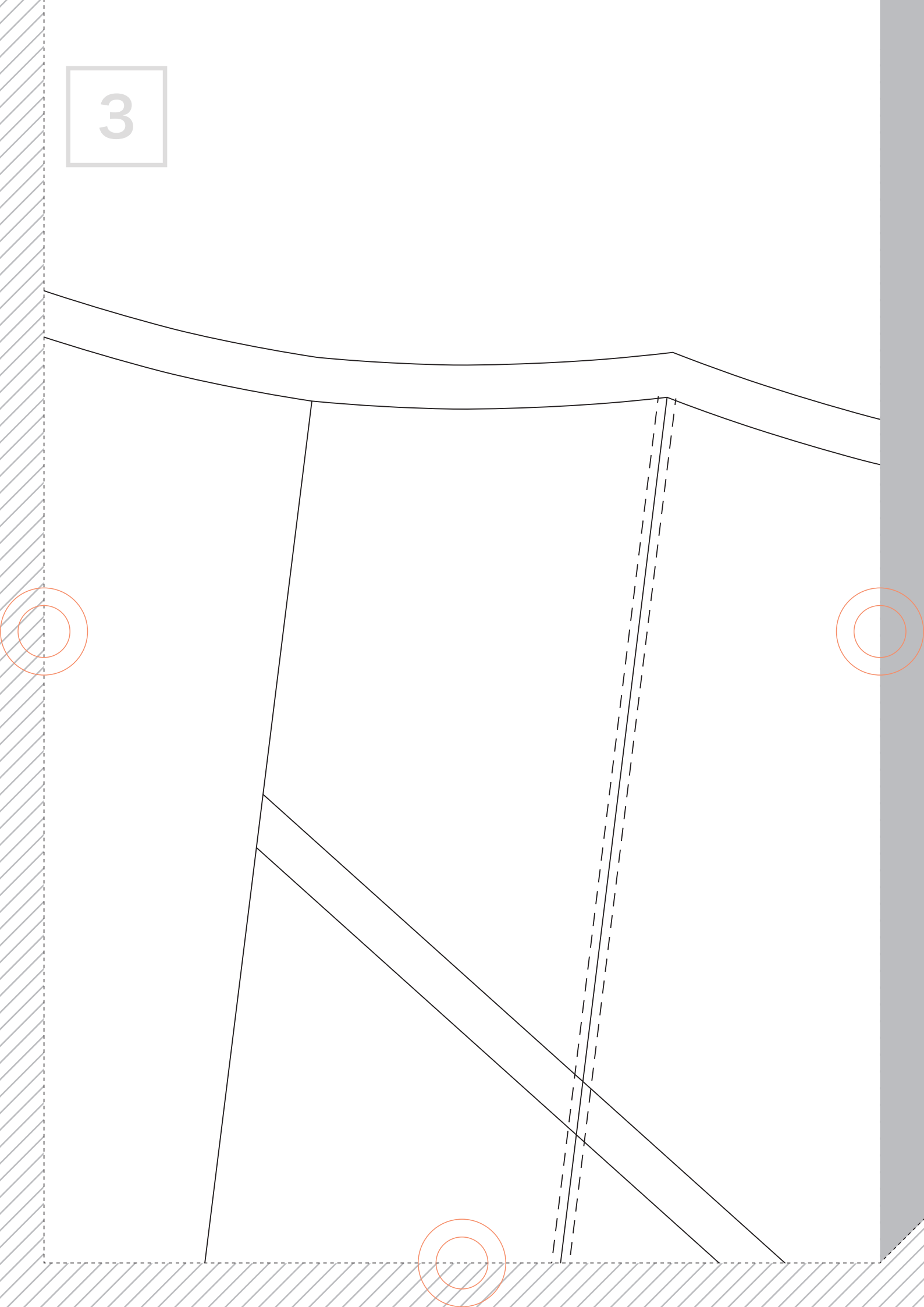

4

F. C

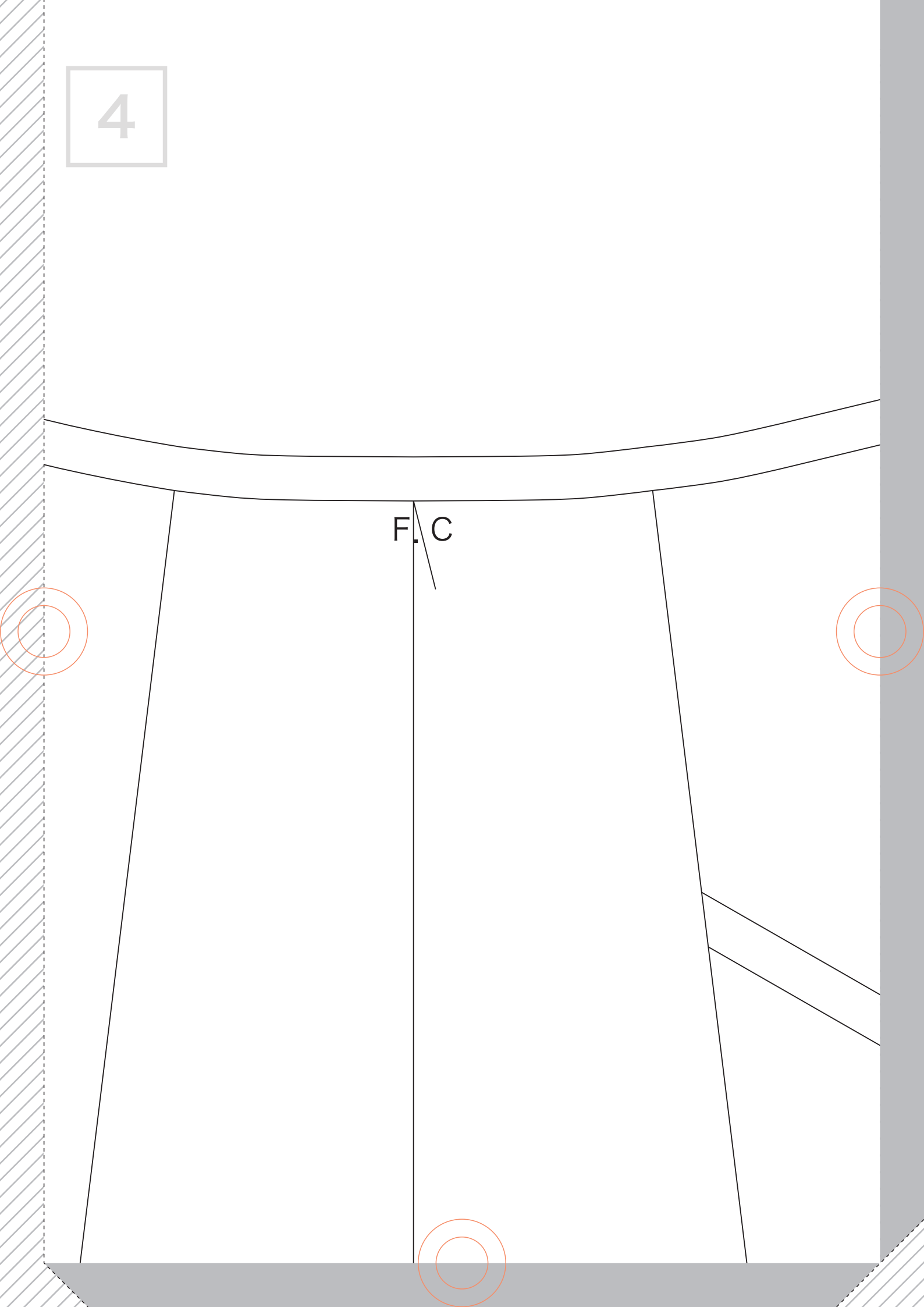

5

1.0

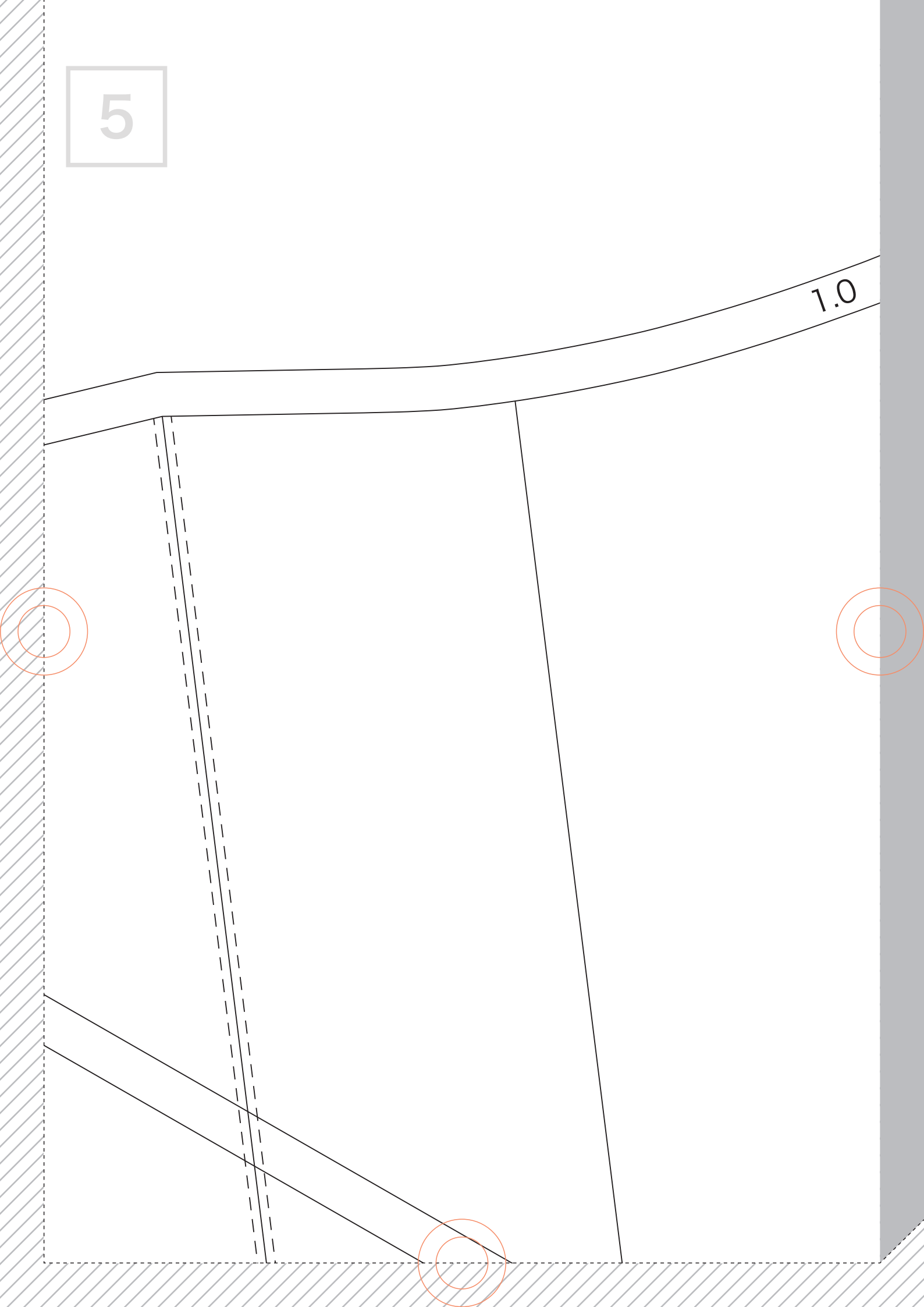

6

左脇

15mm伸び止めテープ

ファスナー開き止まり

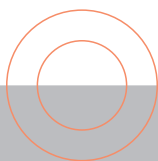
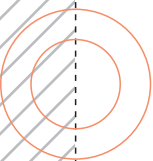

7

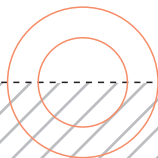
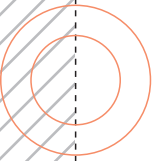

8

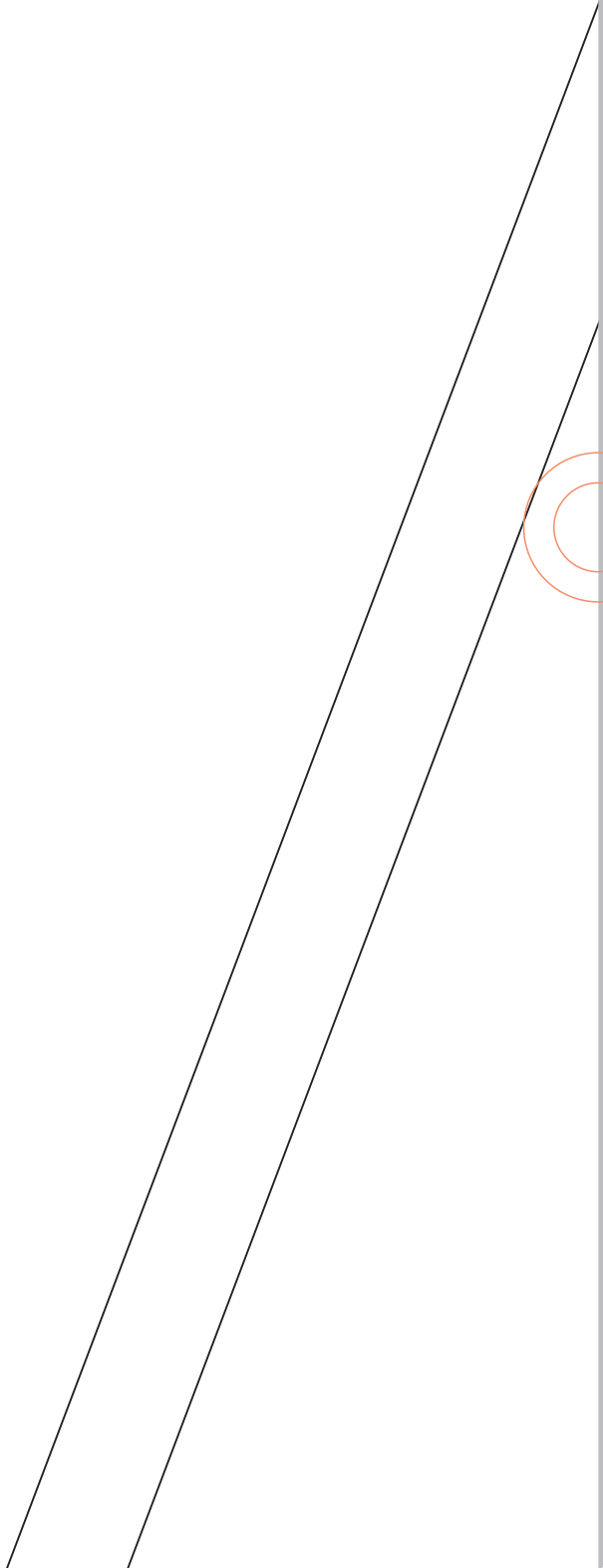
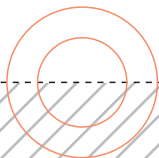
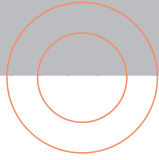

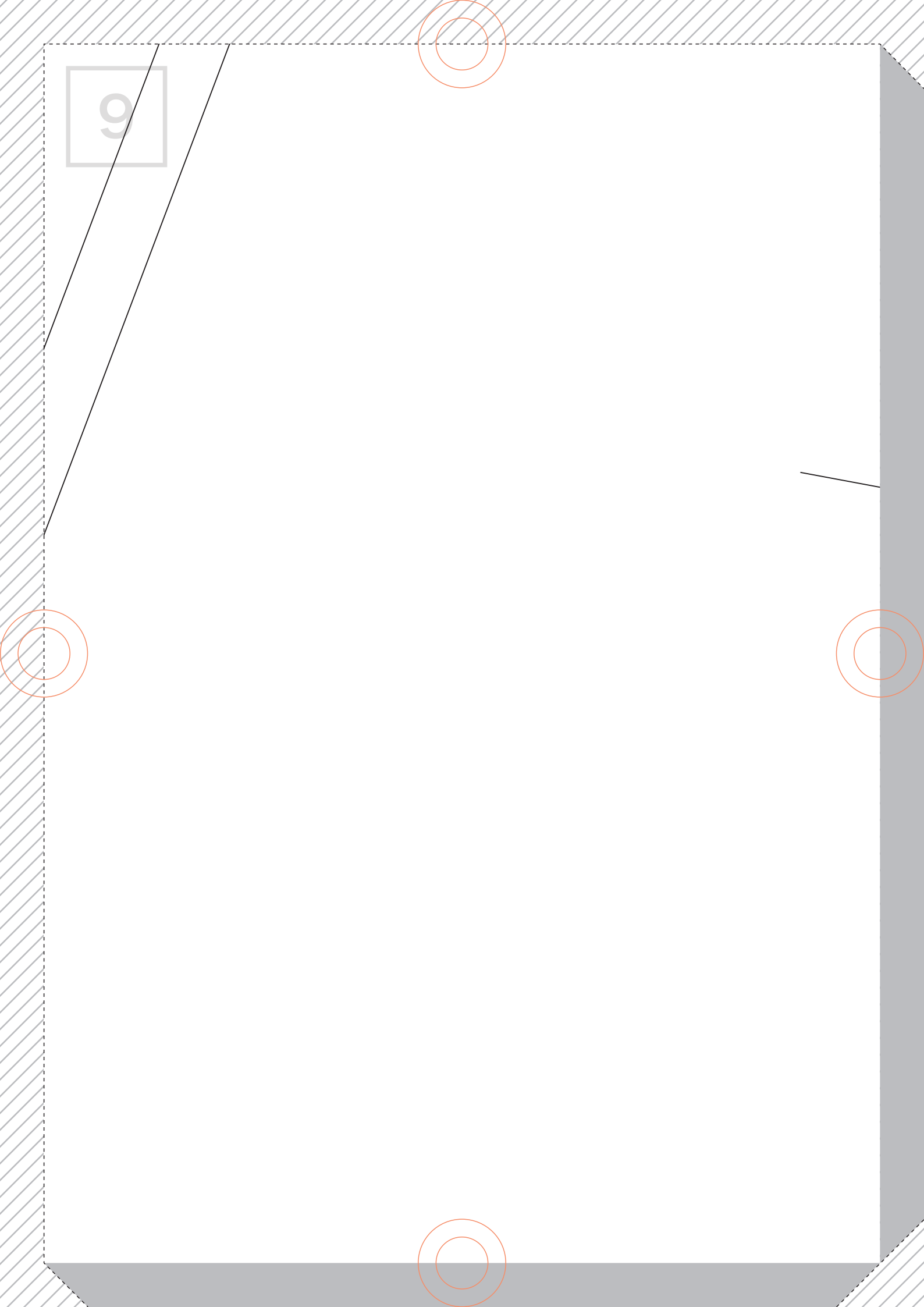

9

10

タックの方向

ひだ奥ステッチ0.2cm幅

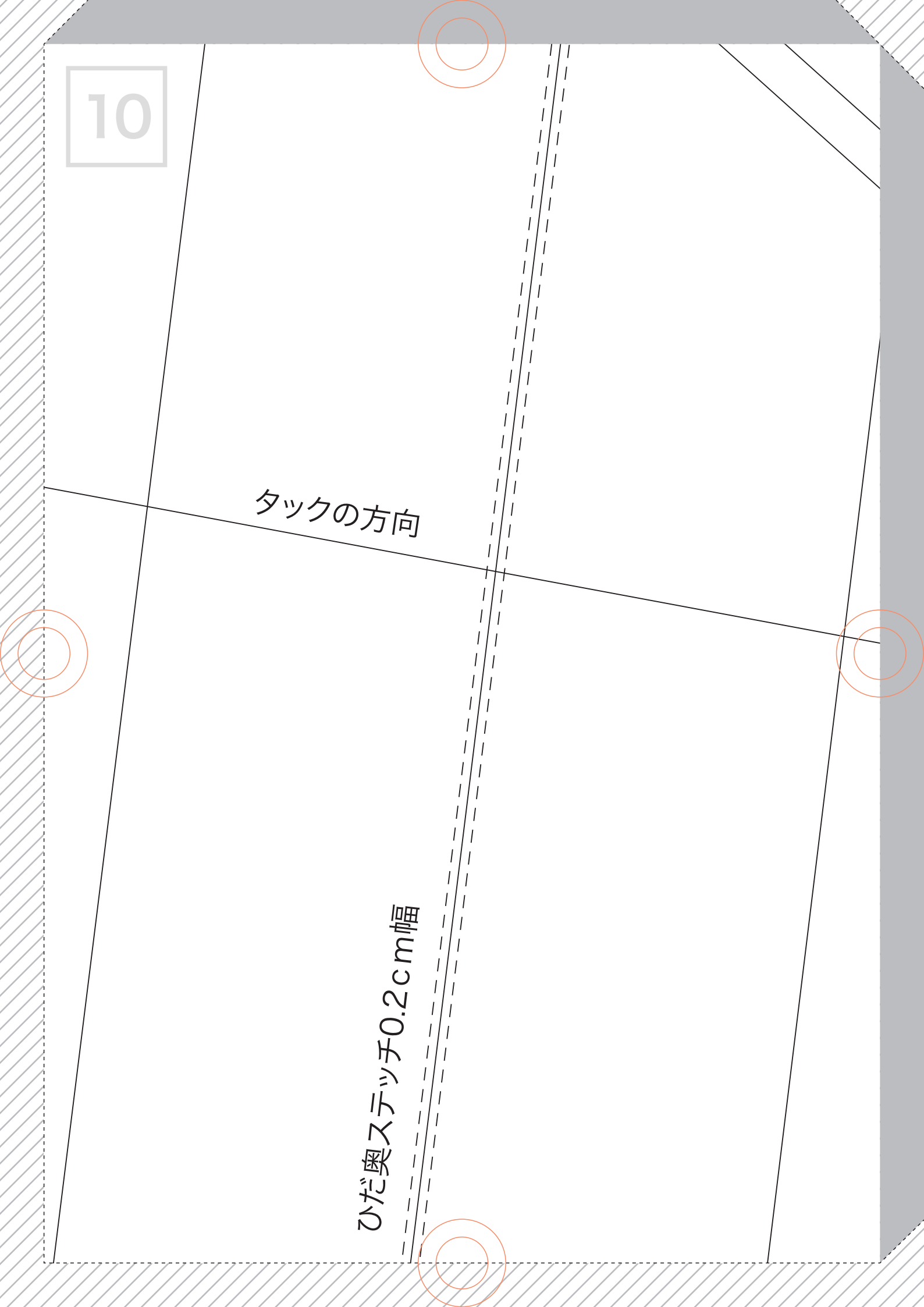

11

f a b f a b - 7

前スカート

size : 9

表 × 1 枚

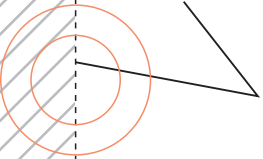

12

タックの方向

ひだ奥ステッチ0.2cm幅

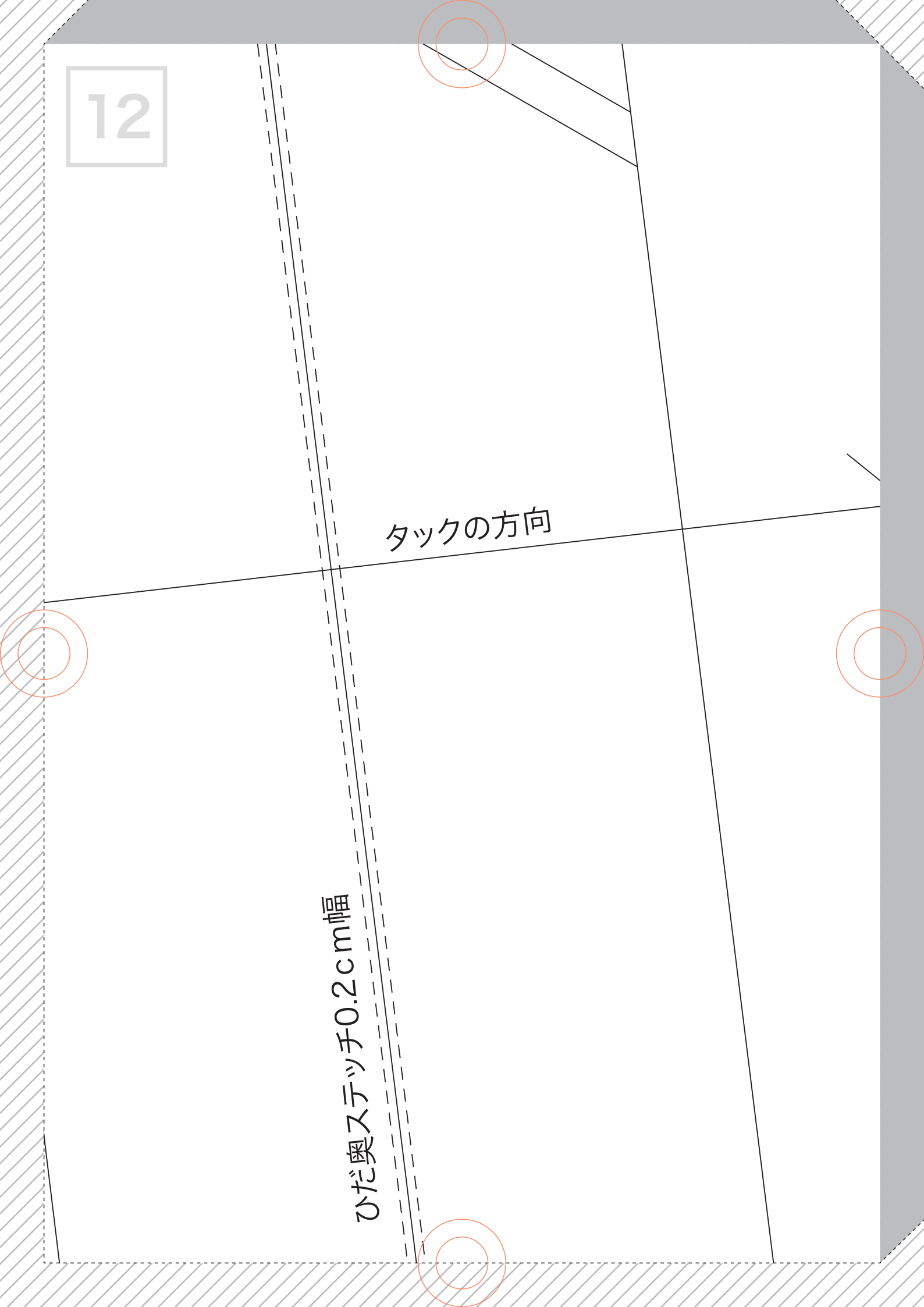

13

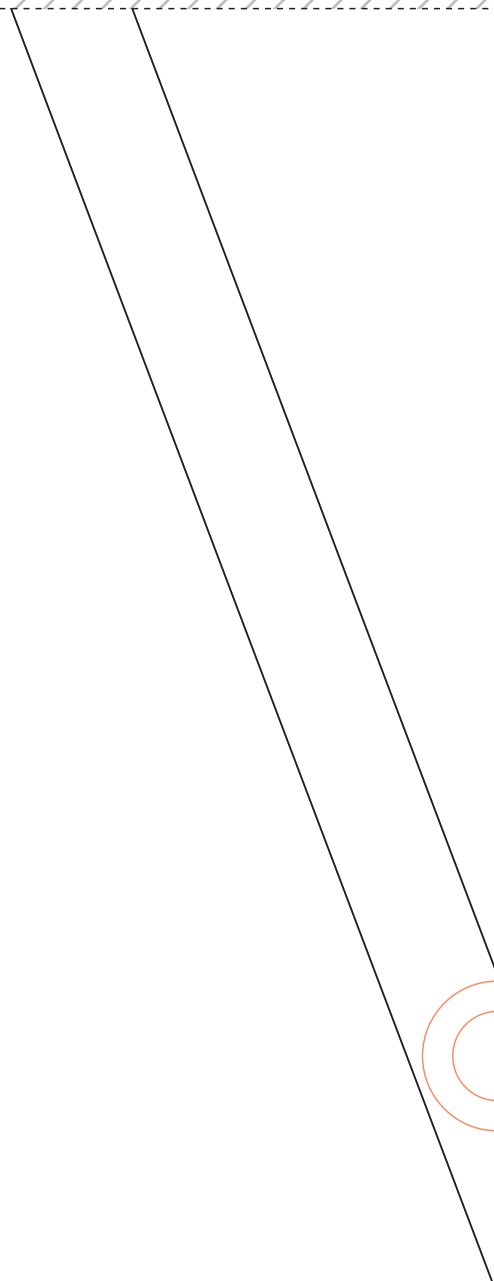
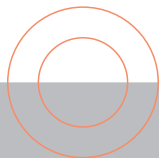
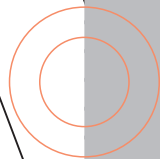
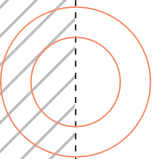
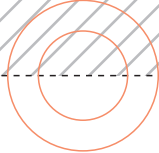

14

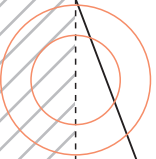
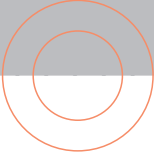

1.5

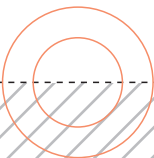

15

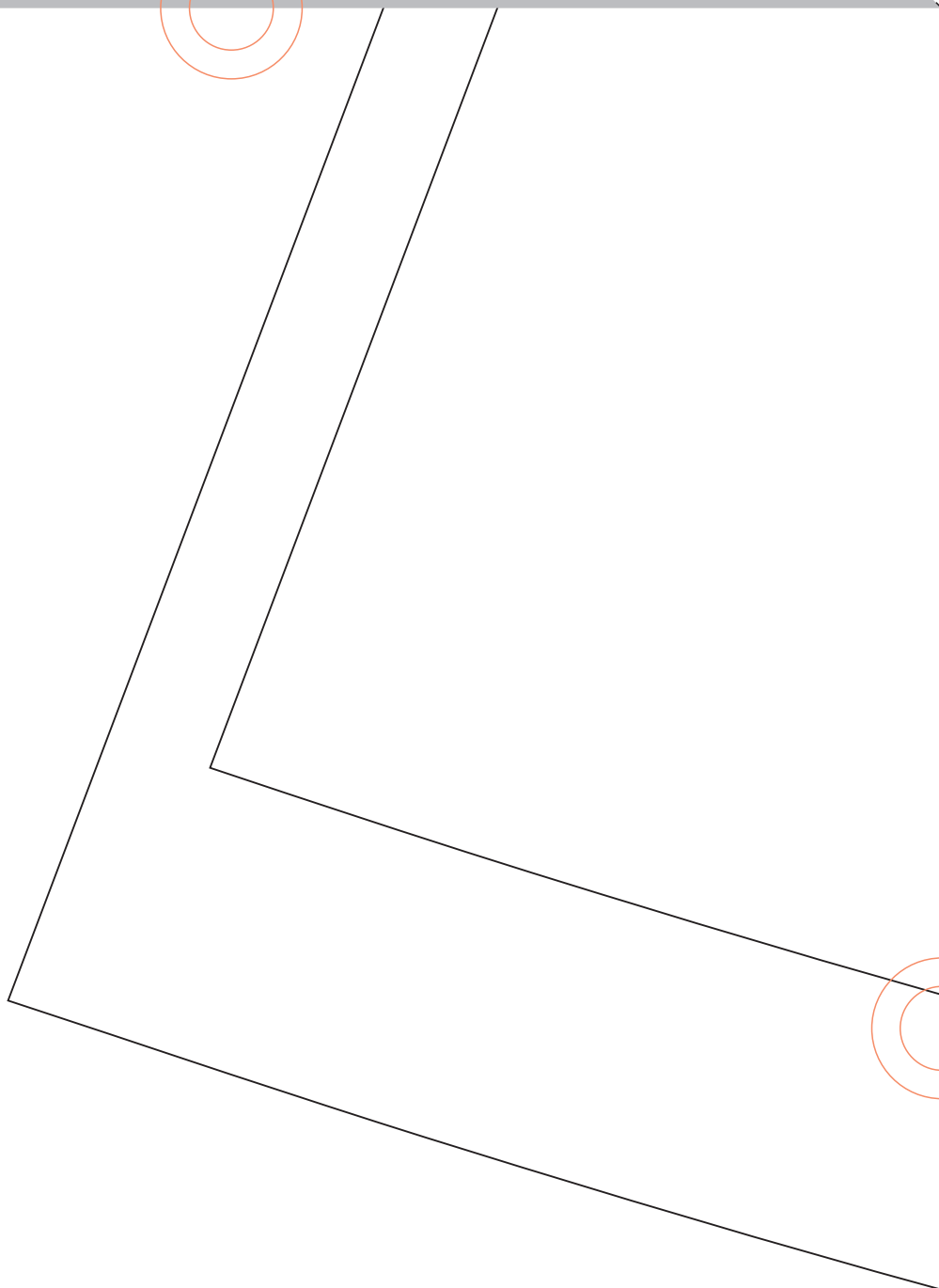

16

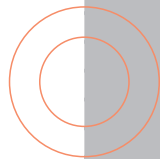
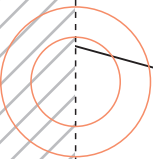
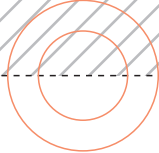

17

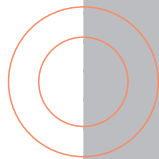
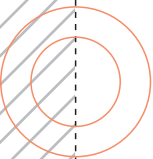

18

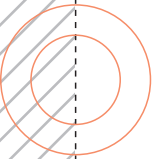
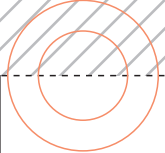

ロックしてまつる

19

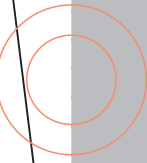
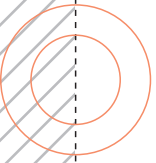
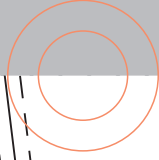

20

4.0

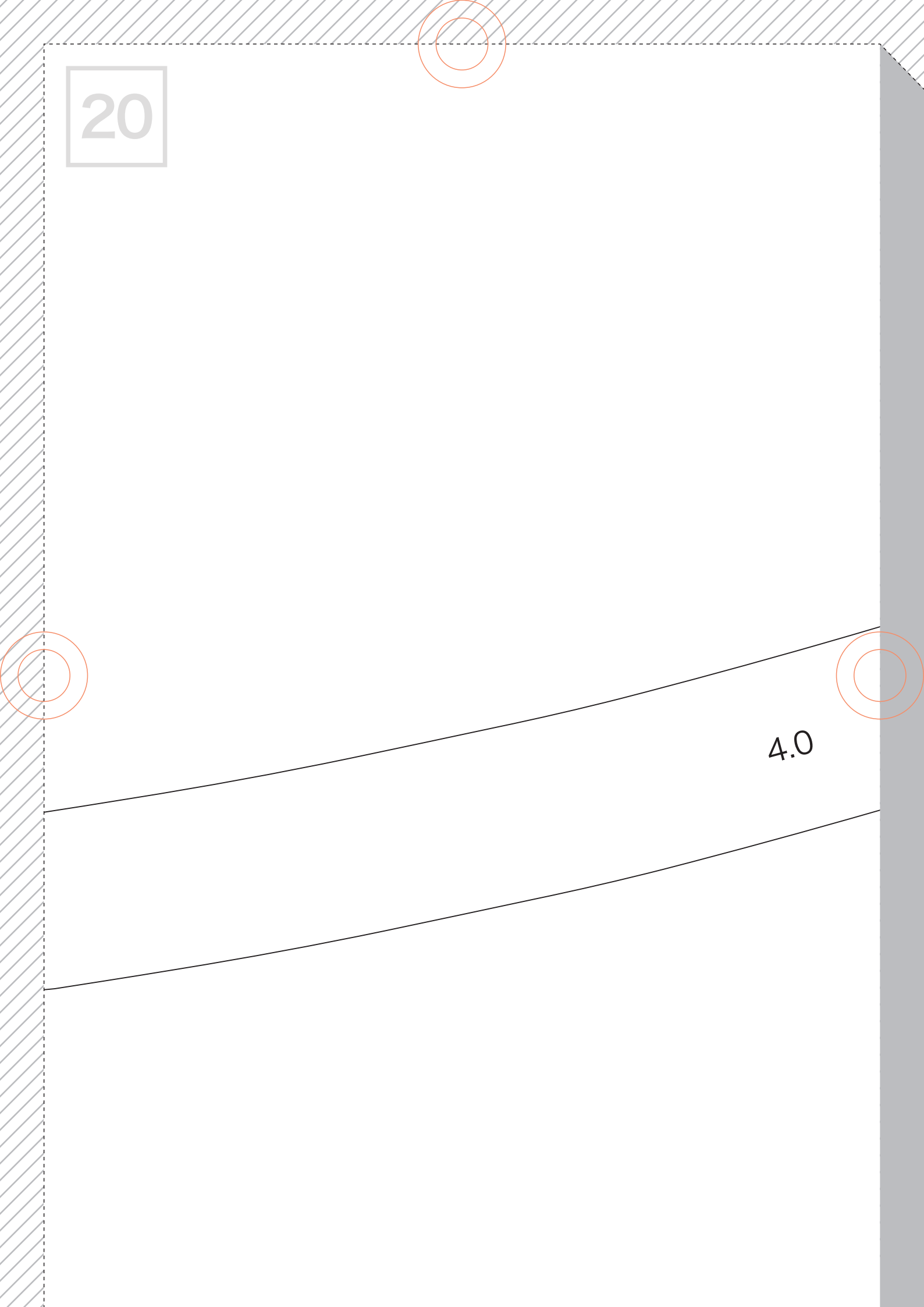

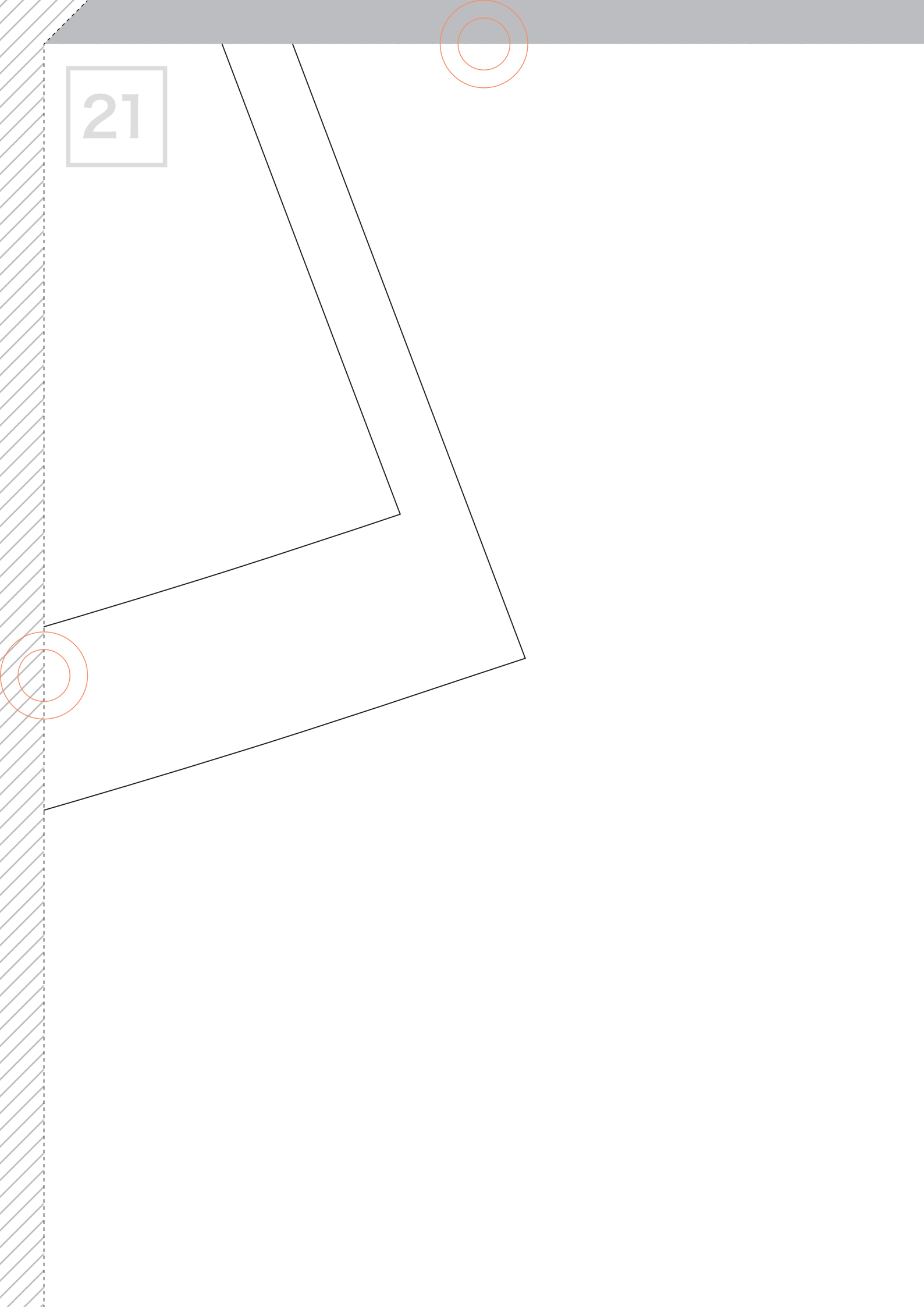

21

22

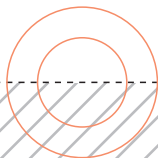

23

左脇

15mm伸び止めテープ

△ファスナー開き止まり

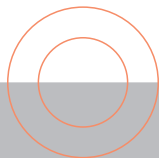
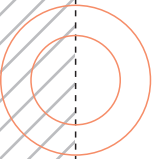

24

タック

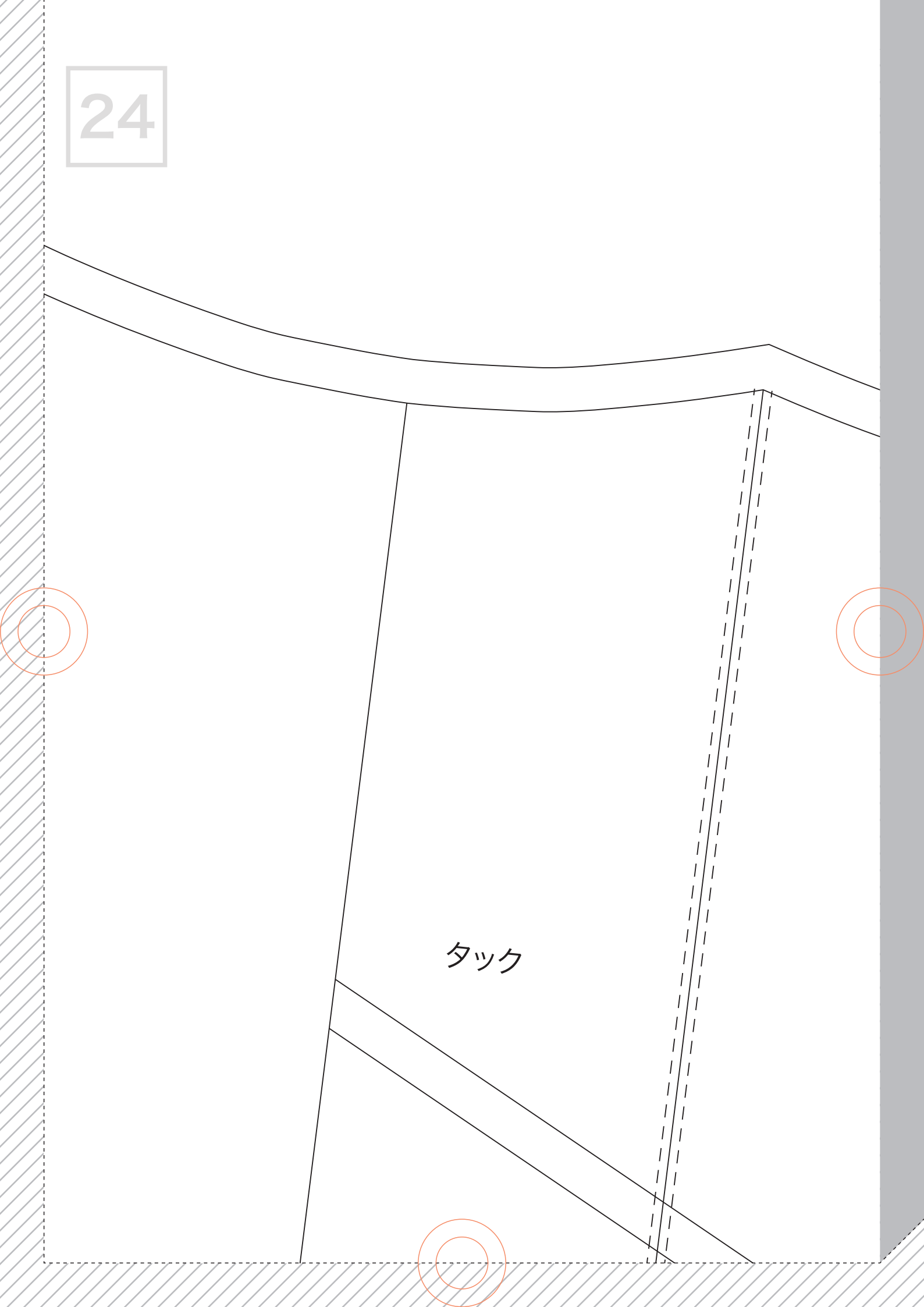
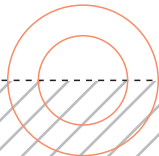
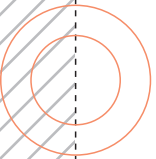

25

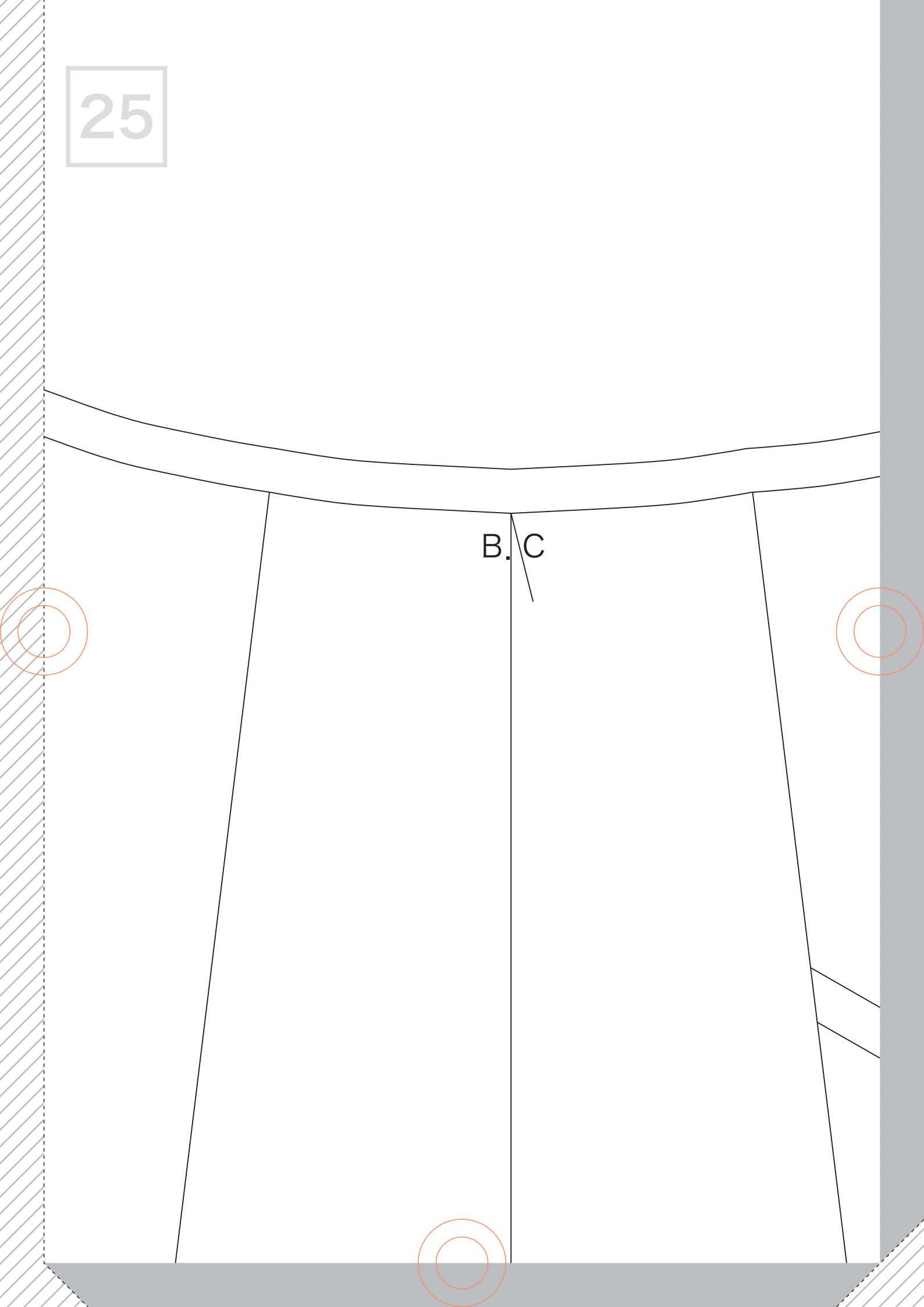

26

1.0

タック

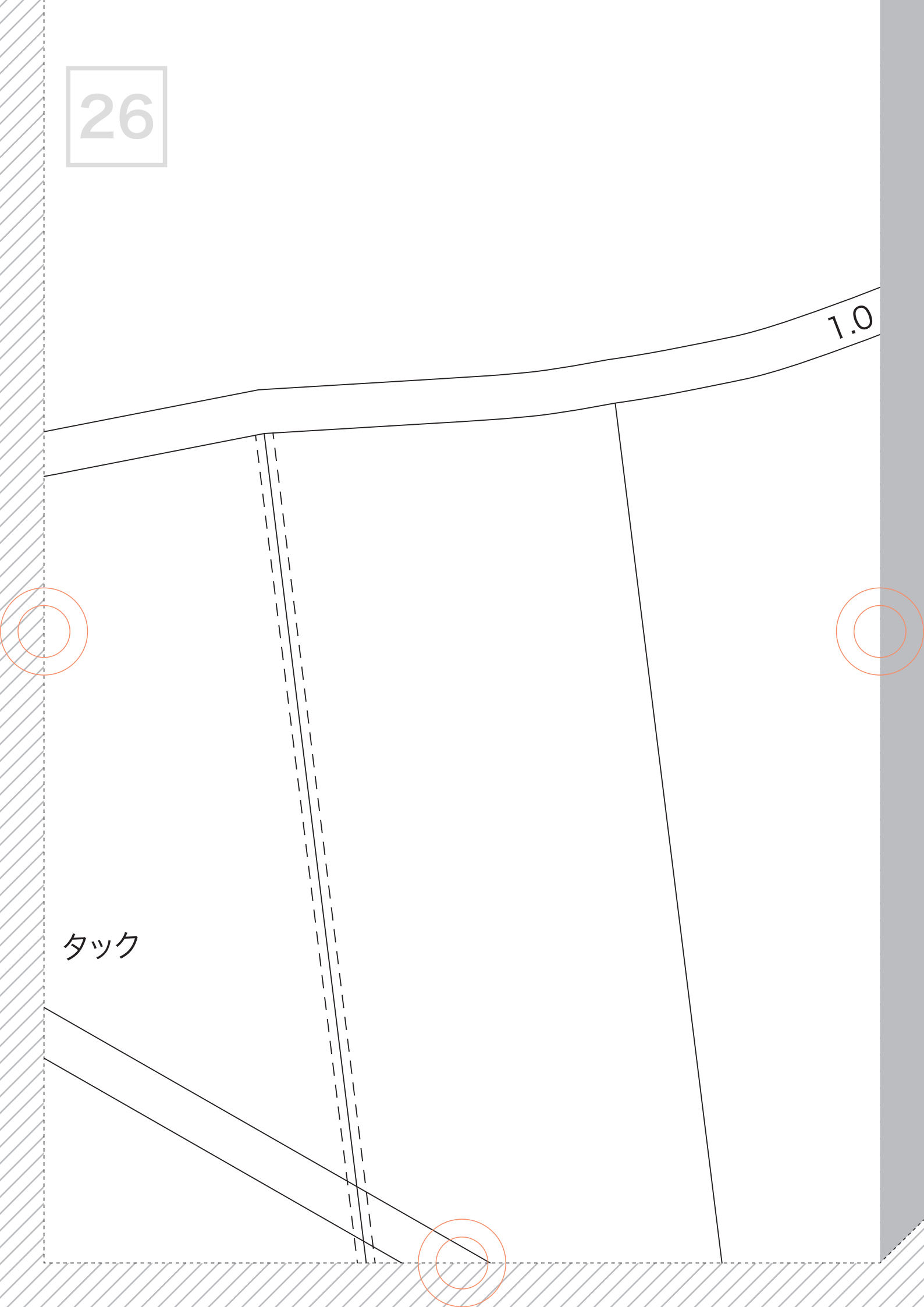

27

右脇

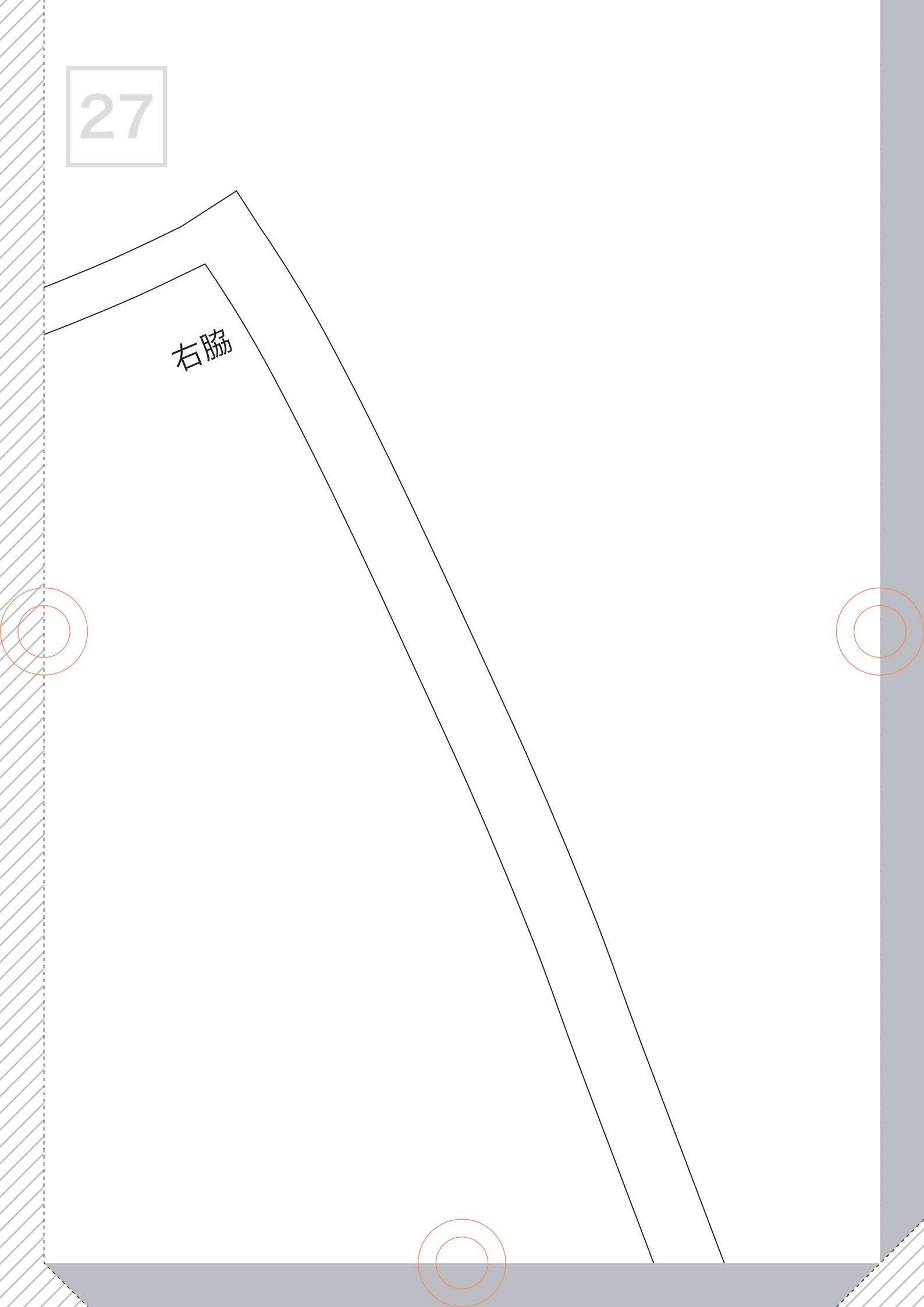
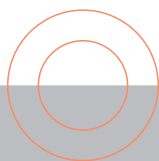
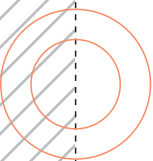

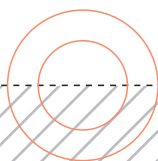
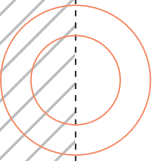

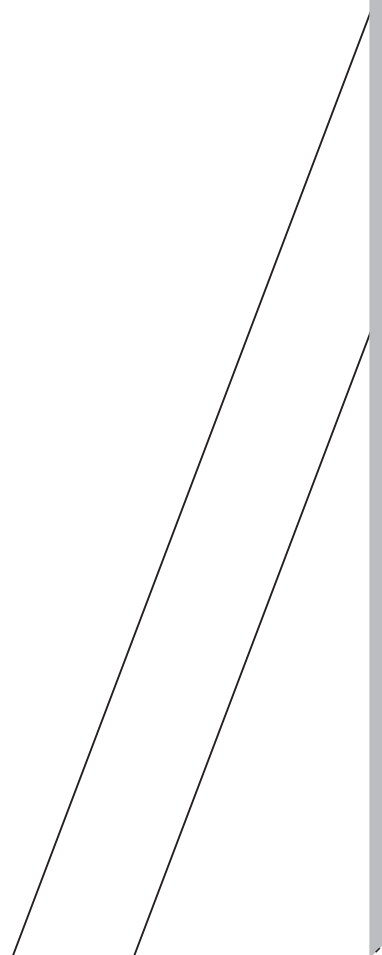
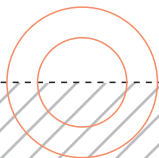
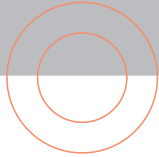

30

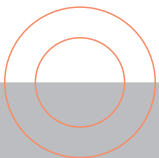
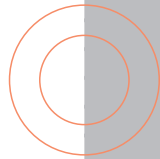
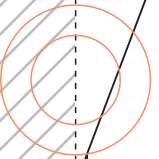
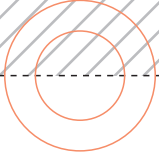

31

タックの方向

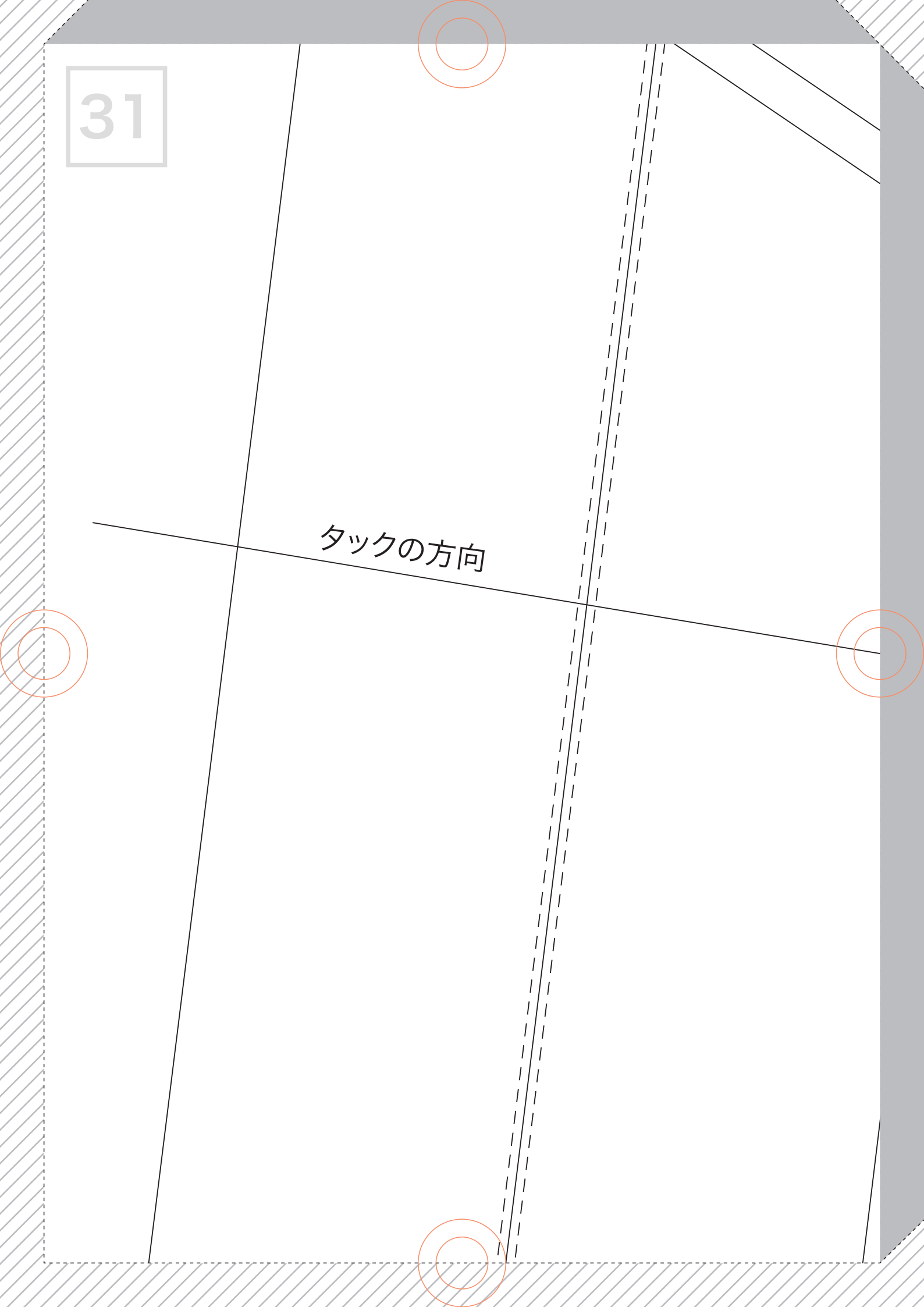

32

f a b f a b - 7

後スカート

size : 9

表 × 1 枚

33

タックの方向

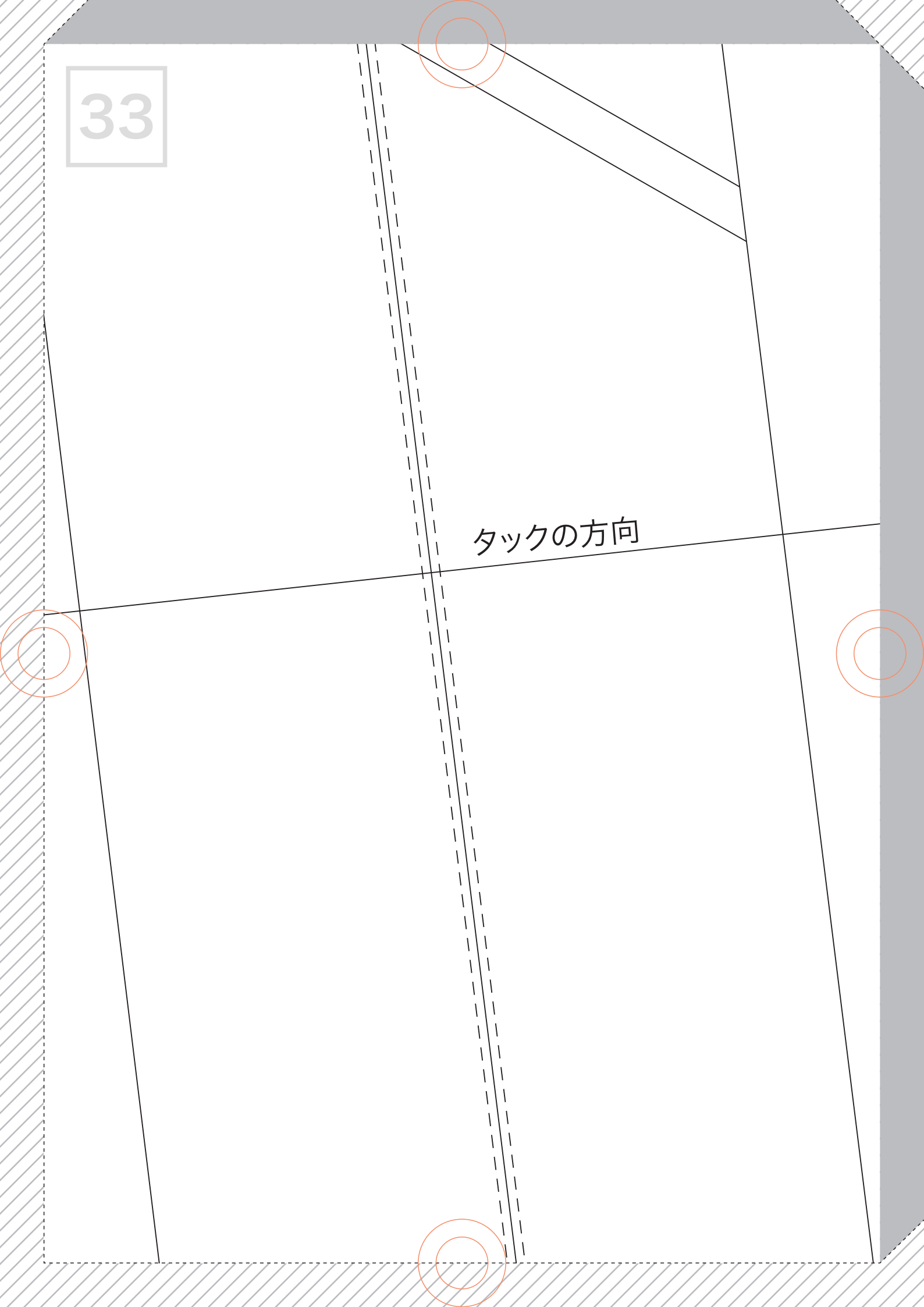

34

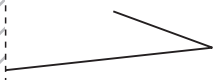
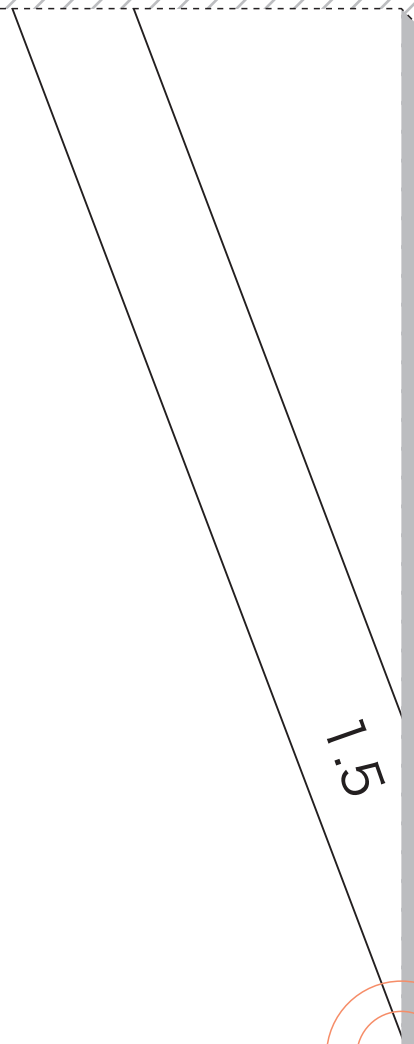
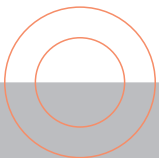
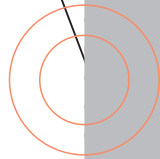
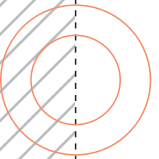
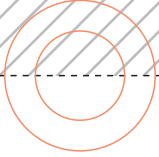

35

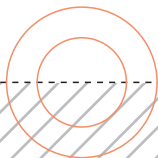
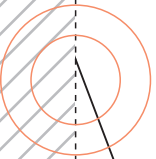
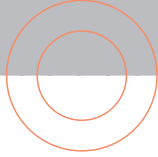

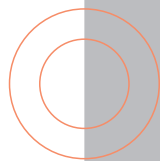
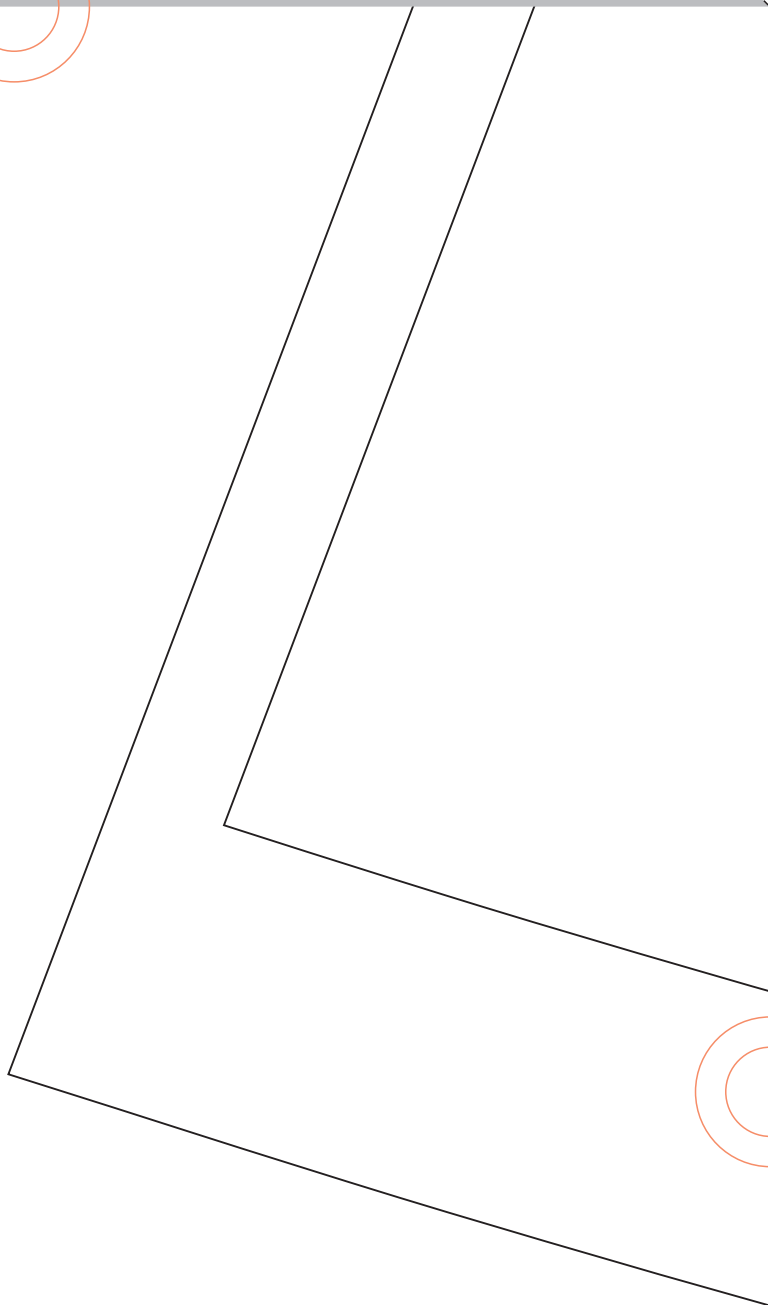

37

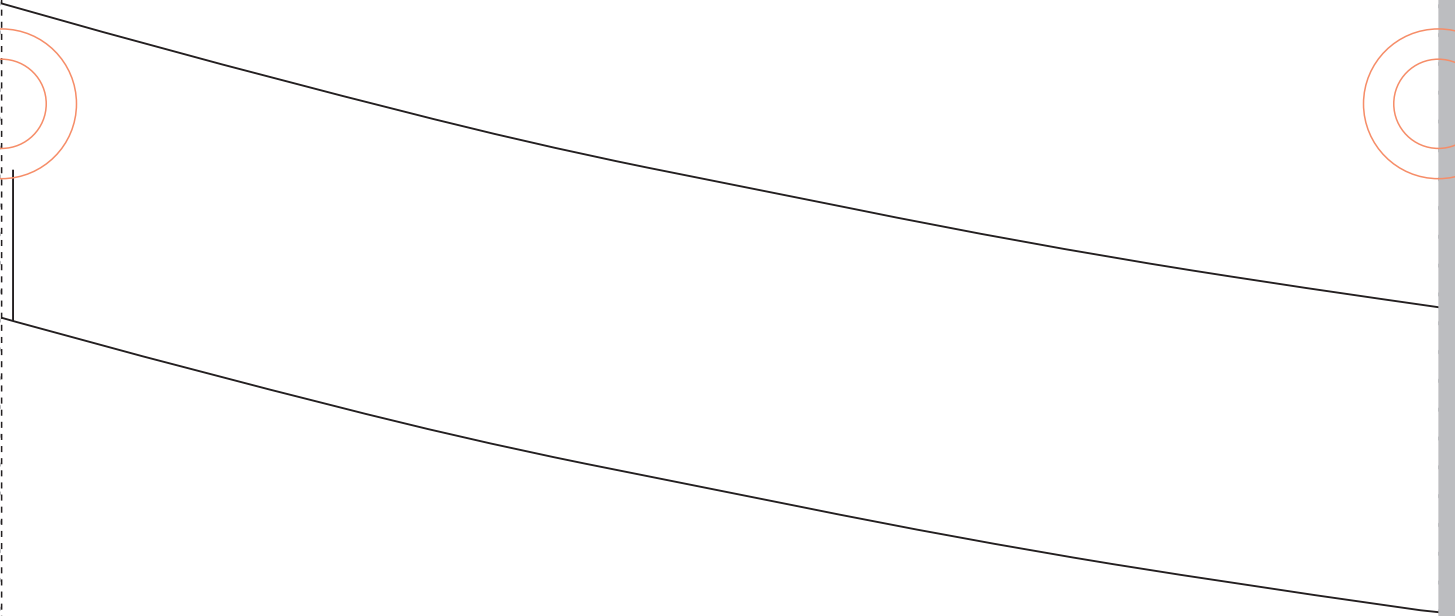
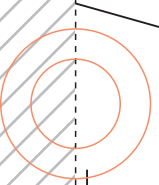
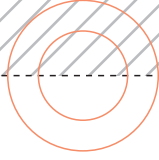

38

ひだ奥ステッチ0.2cm幅

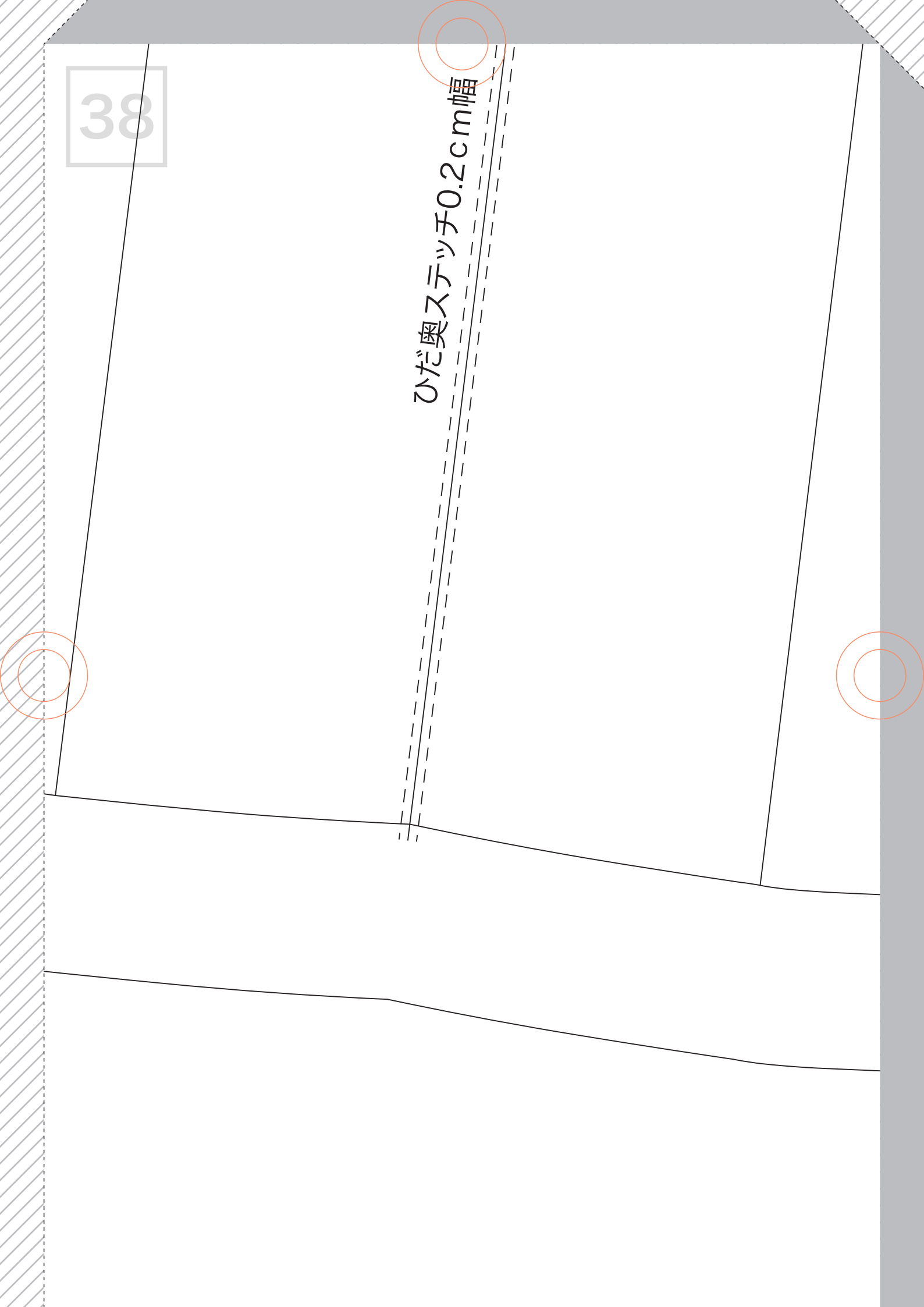

39

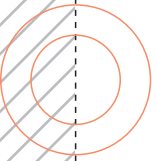
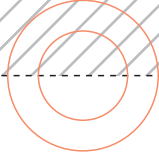

ロックしてまつる

40

ひだ奥ステッチ0.2cm幅

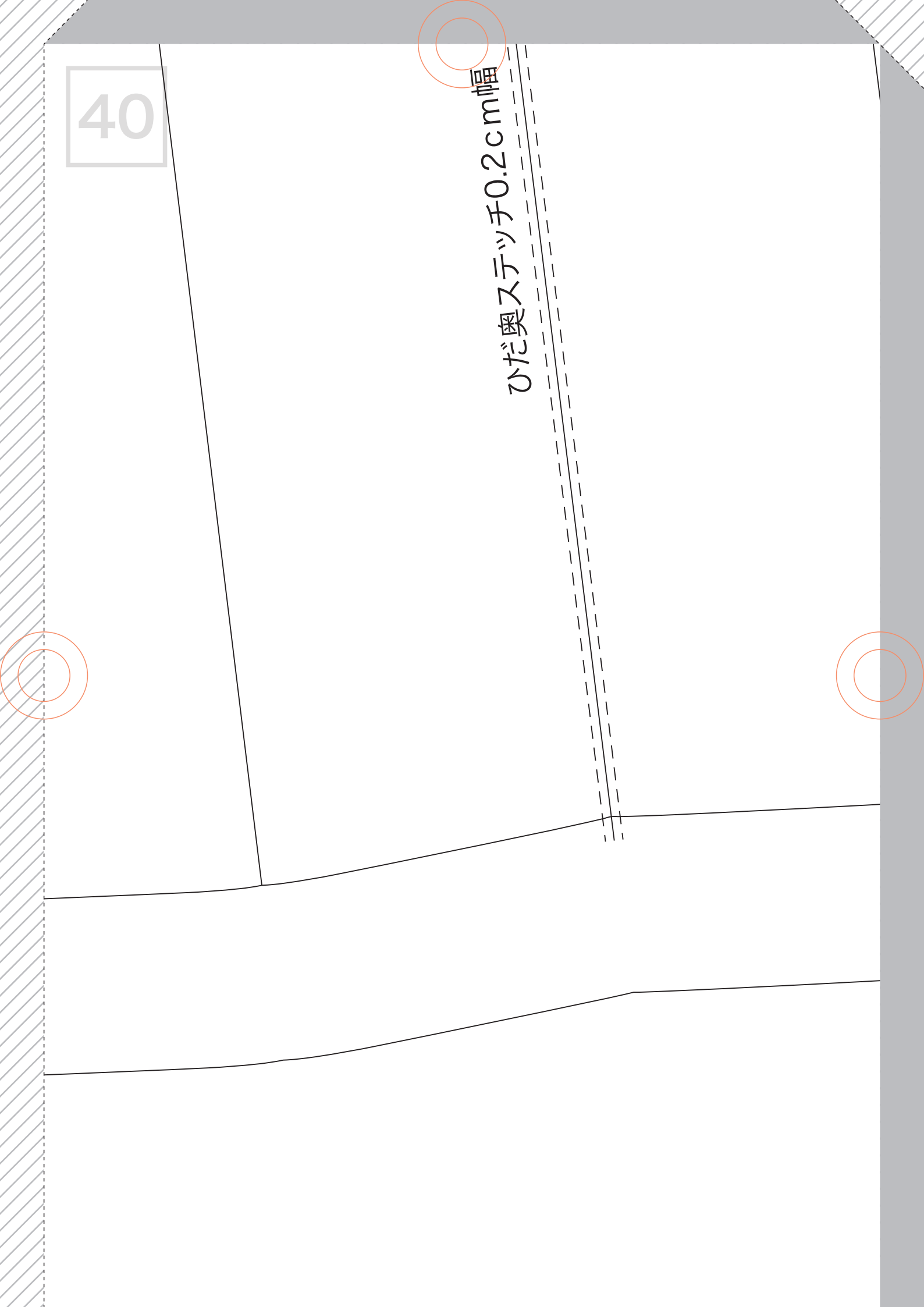

41

4.0

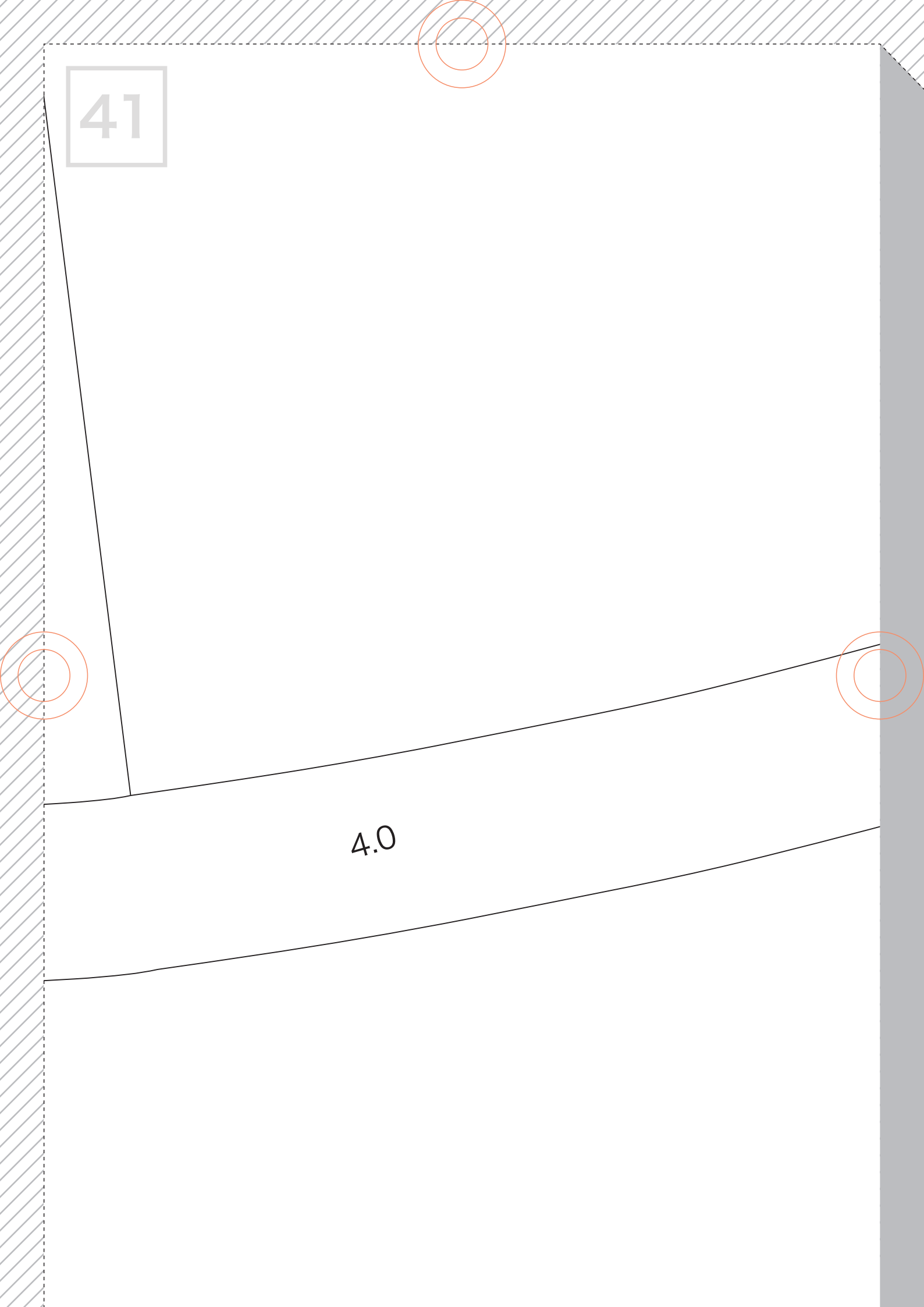

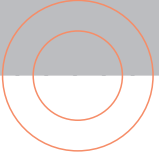

42

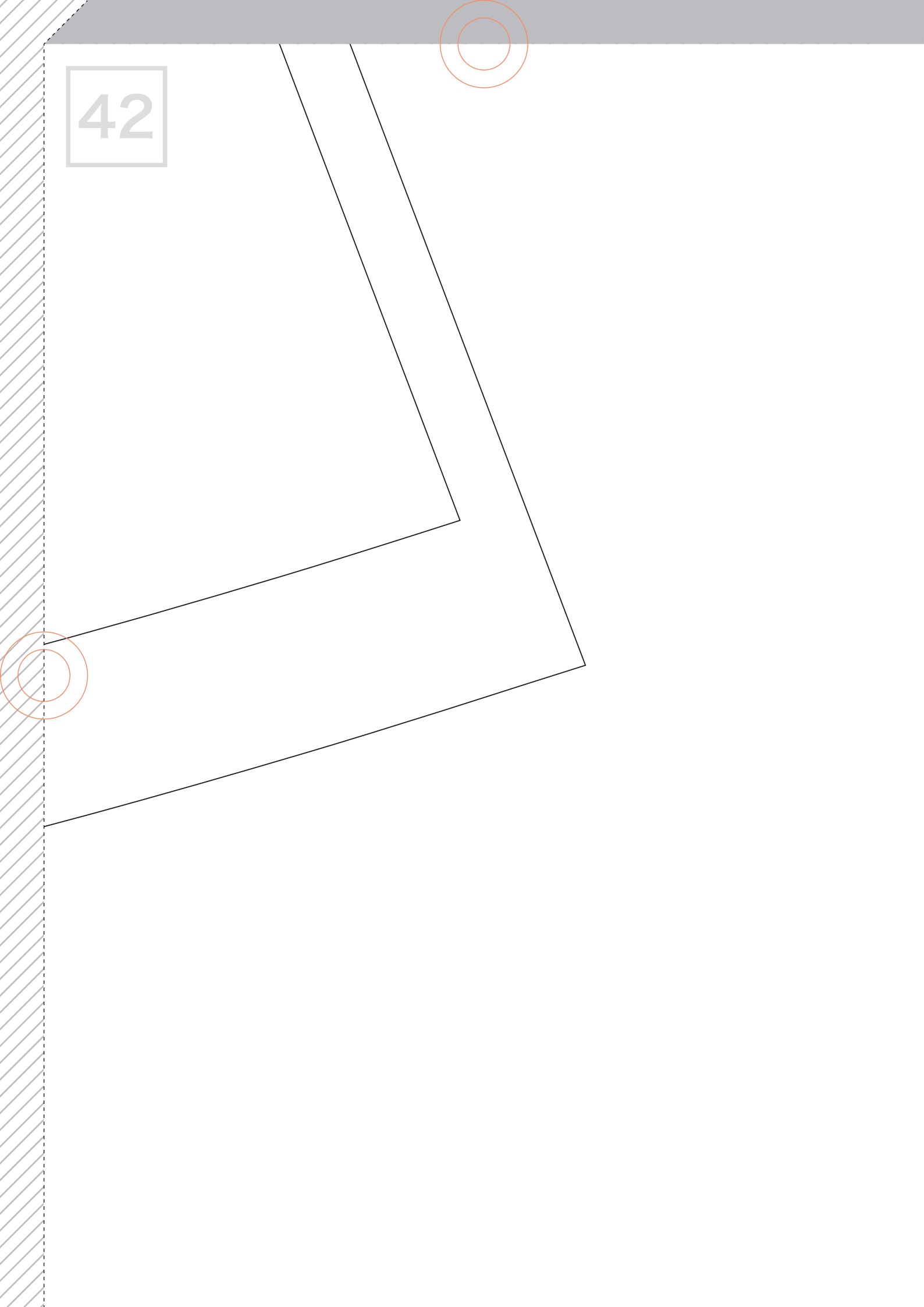
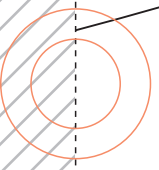

43

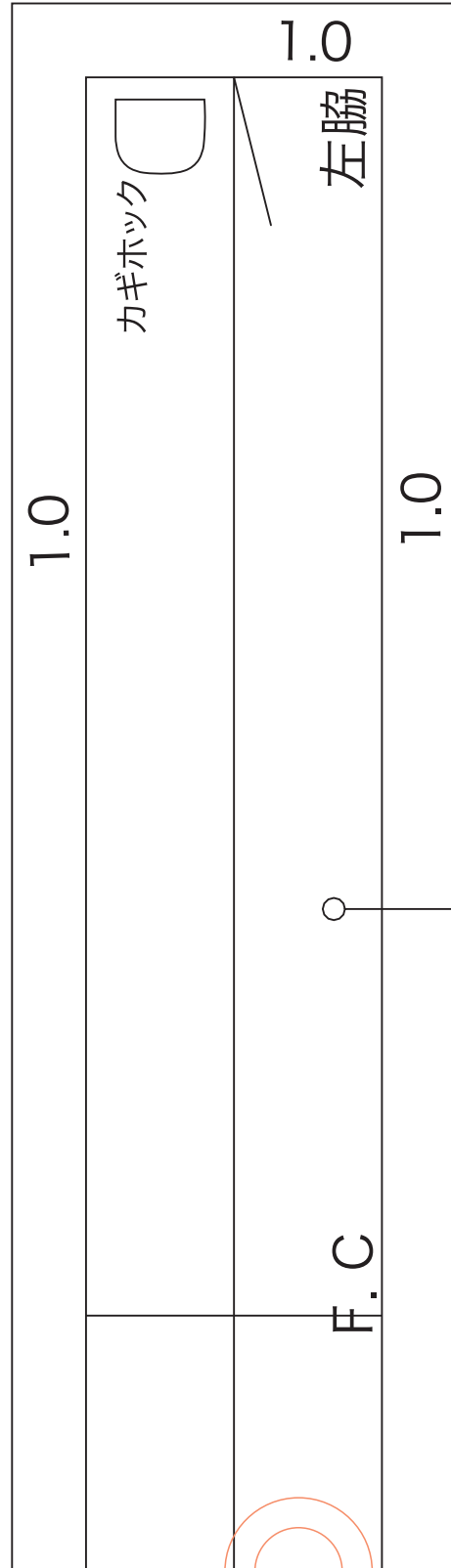

切り取る (斜線部はカット)



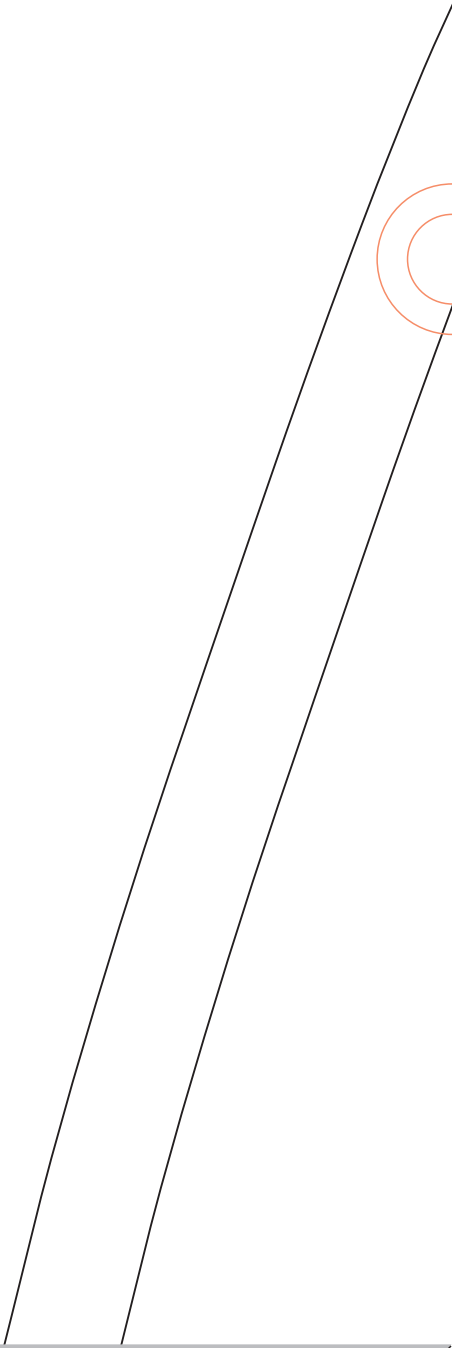
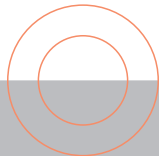
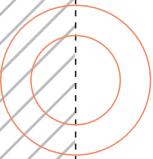

45

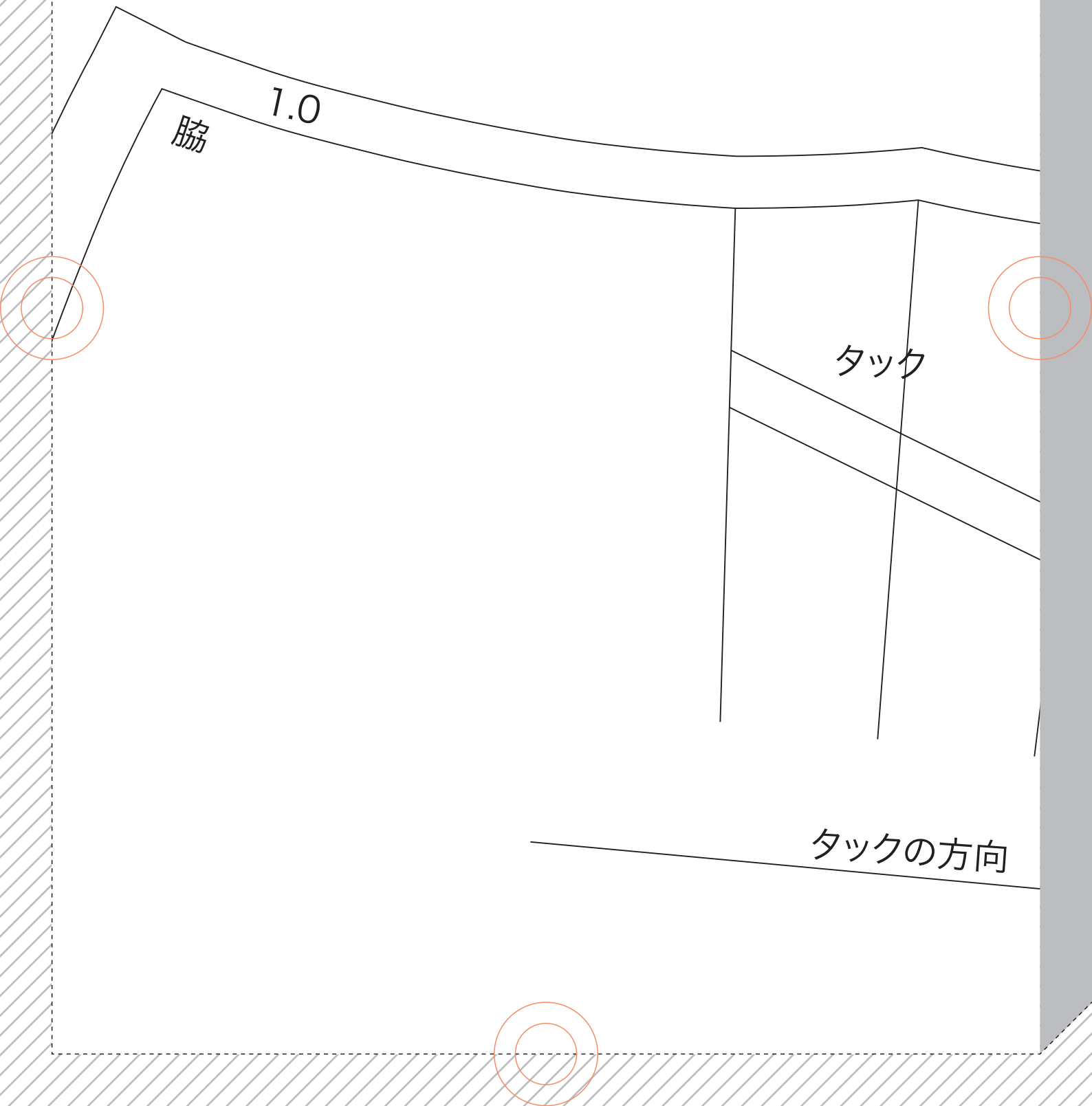

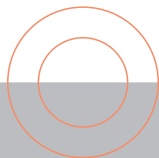
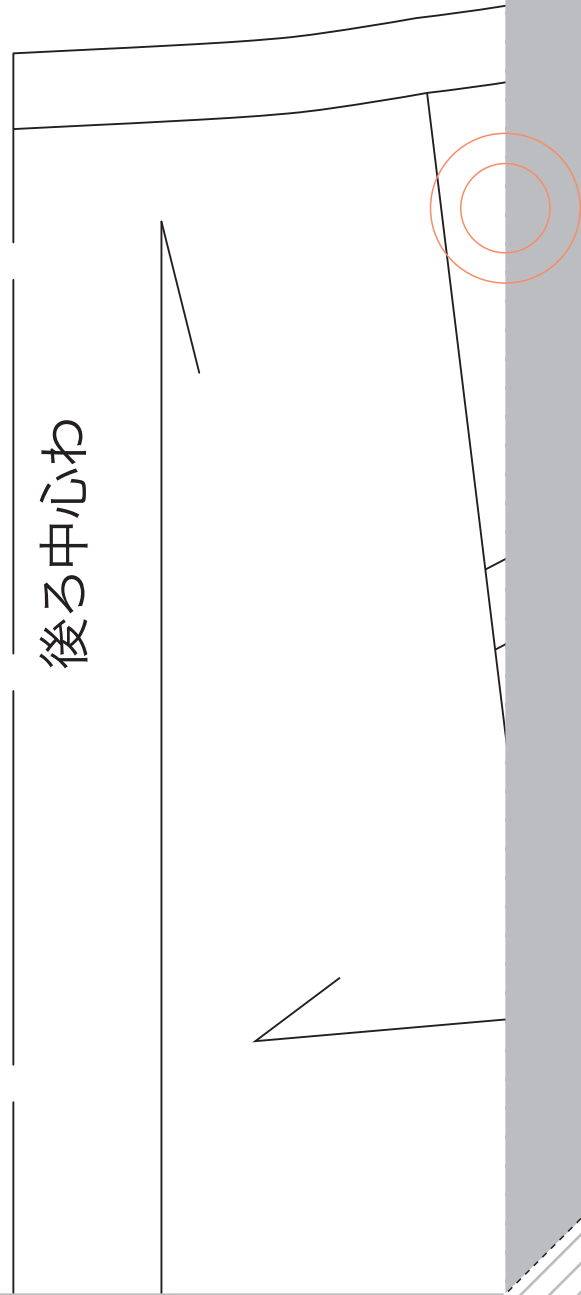
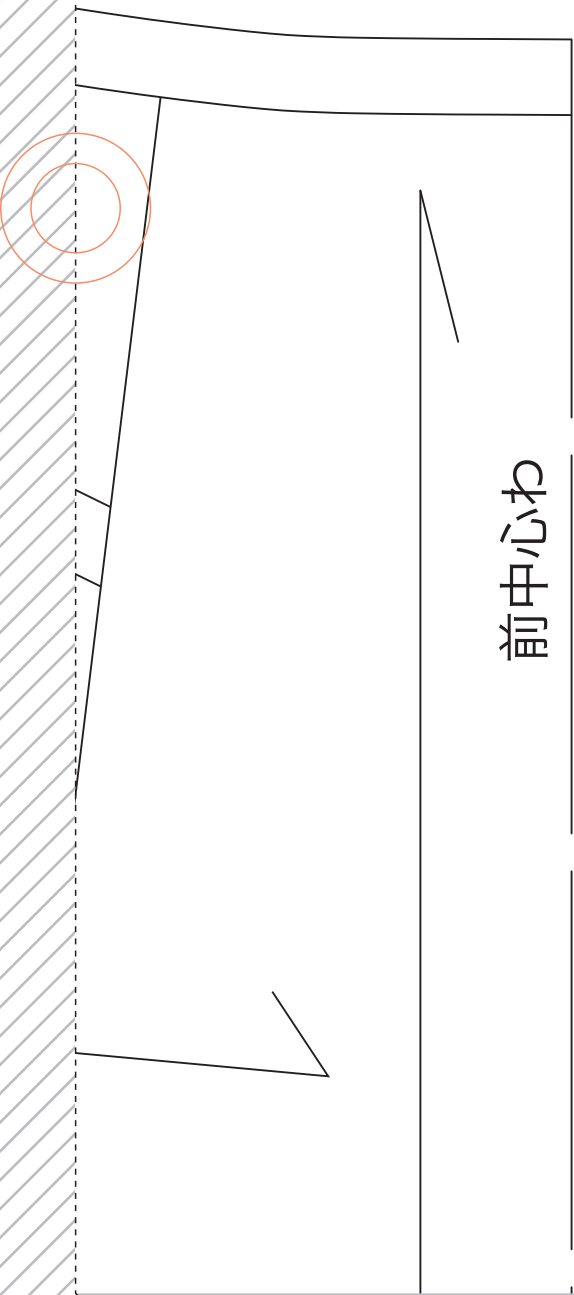

47

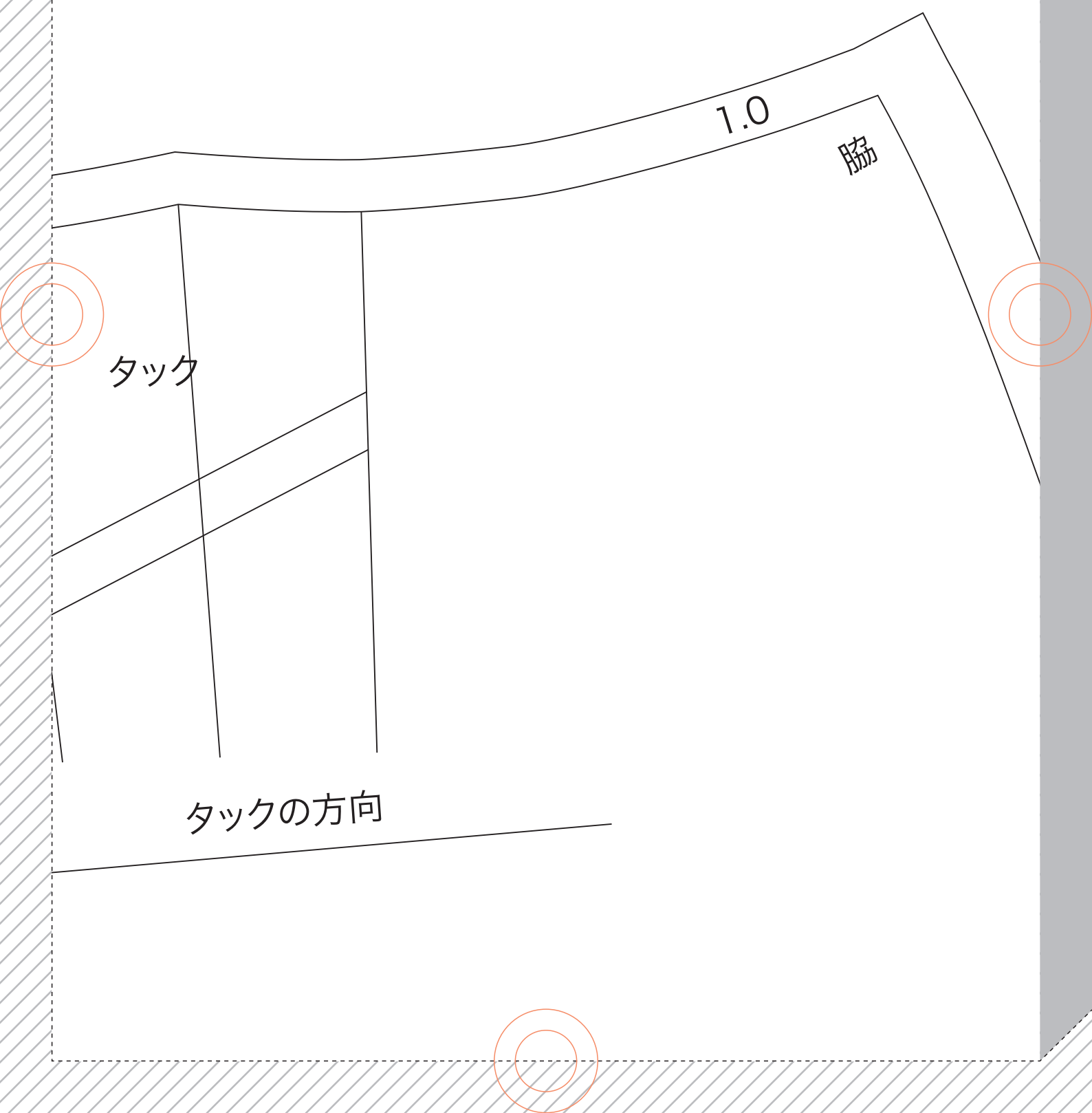

タック

1.0

脇

タックの方向

48

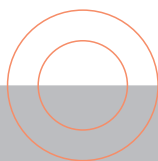
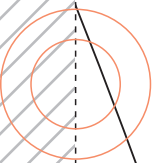

fabfab-7
ベルト

size: 9
表×1枚

2cm巾インベル
右脇

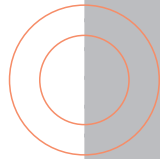
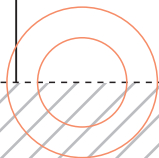
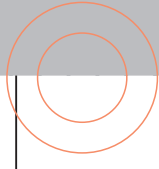

50

裏地ファ

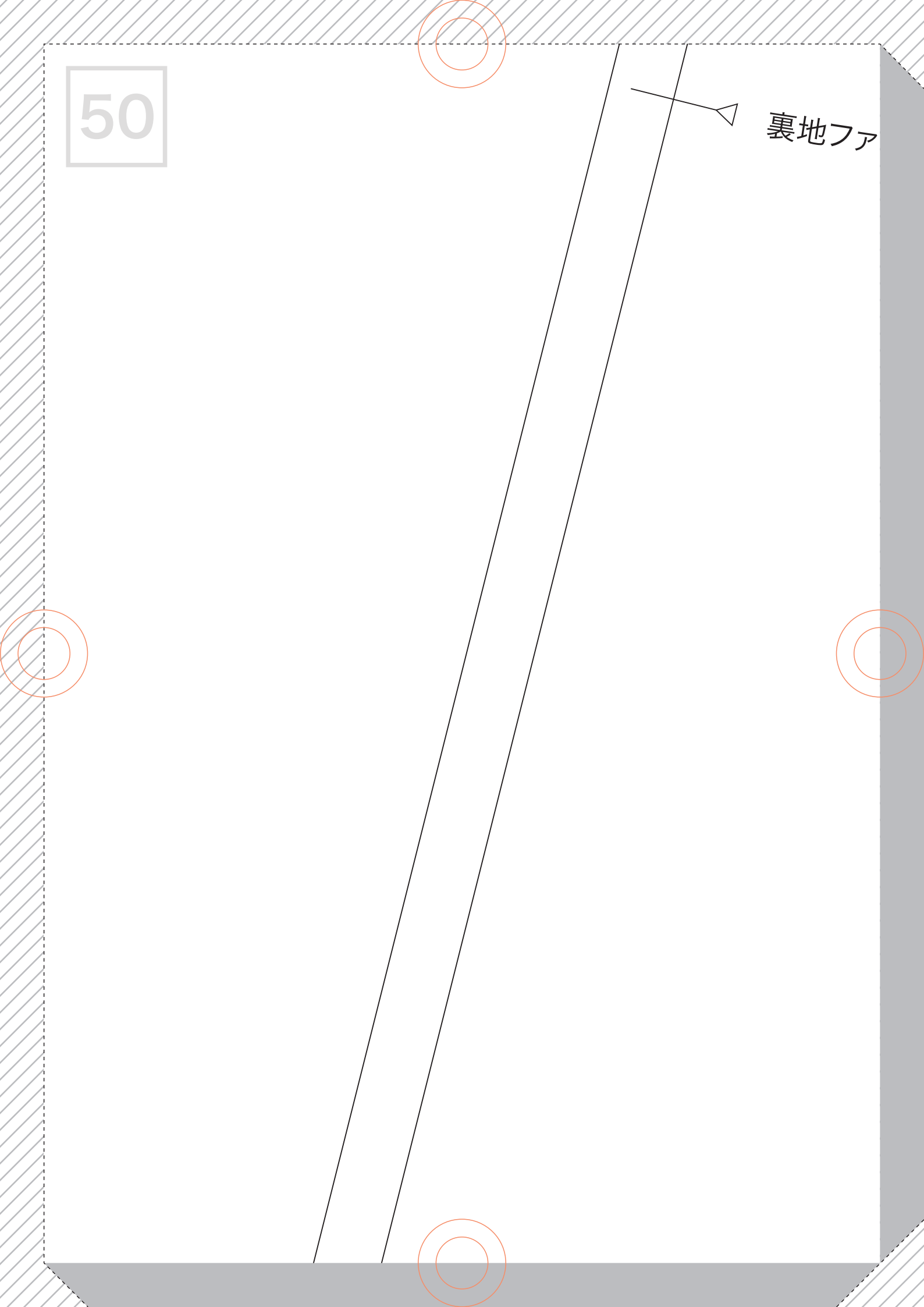

51

スナー止まり

f a b f a b - 7

裏前スカート

size : 9

裏 × 1 枚

52

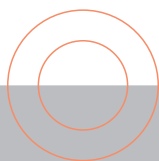
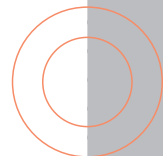
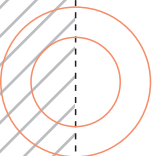
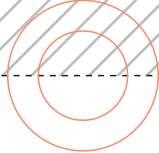

53

裏地ファスナー

f a b f a b-7

裏後スカート

size : 9

裏×1枚

止まり

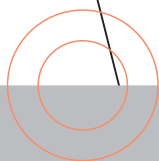
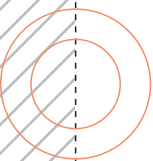
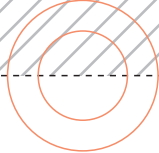

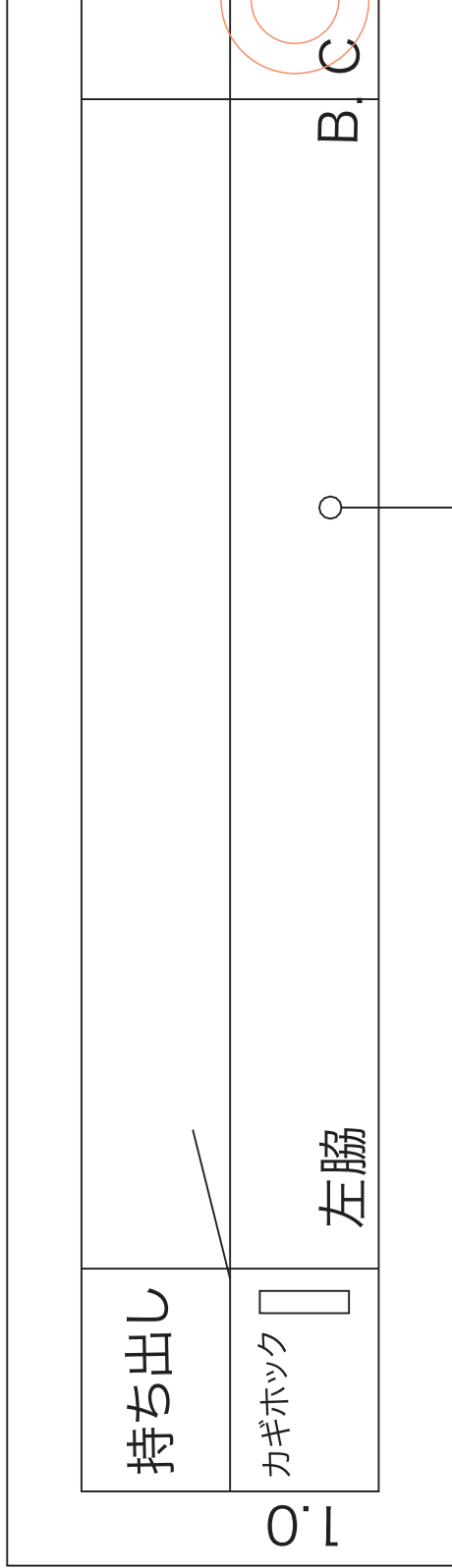

56

1.5

3.0

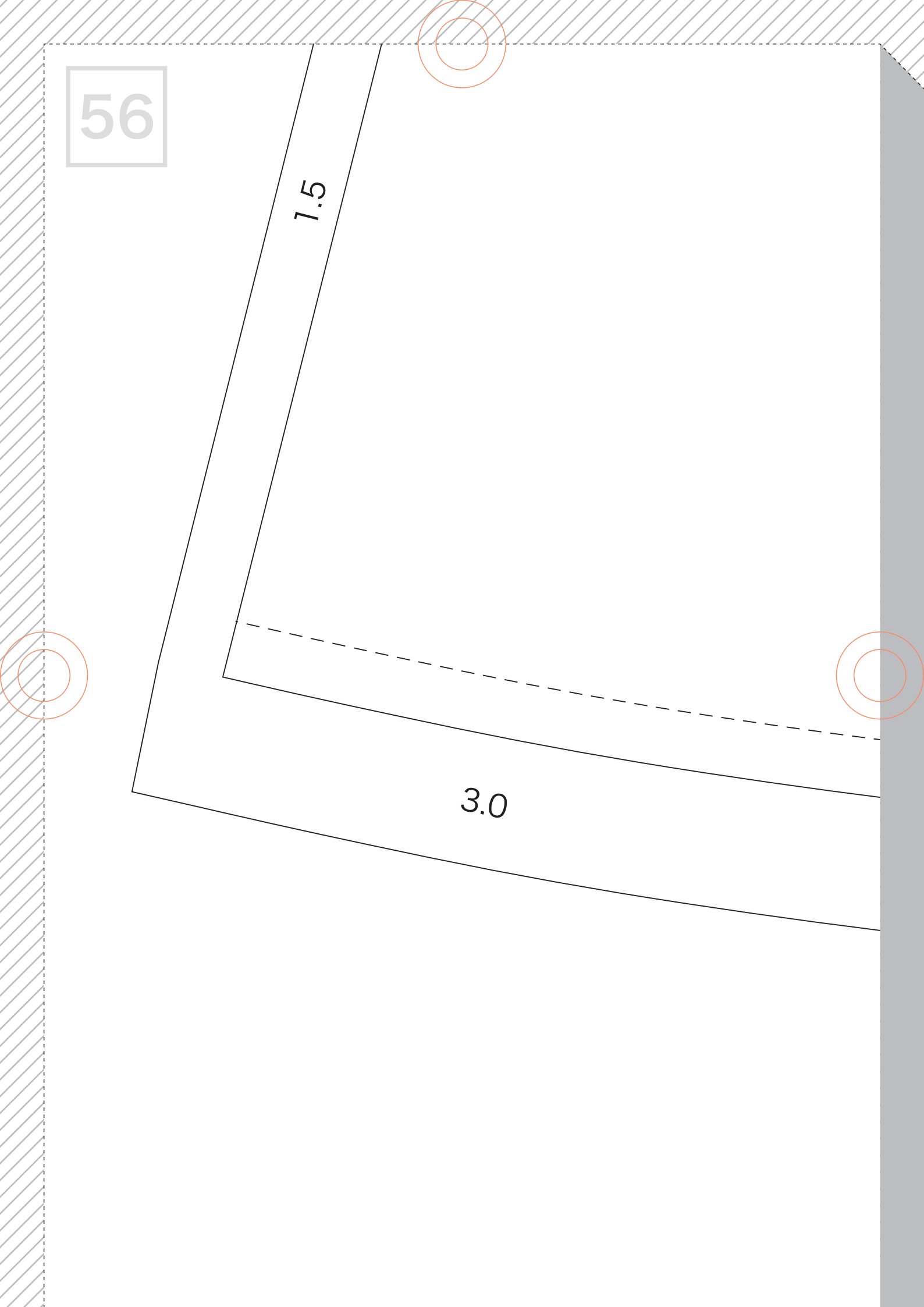

57

1.5cm幅三つ折りステッチ

58

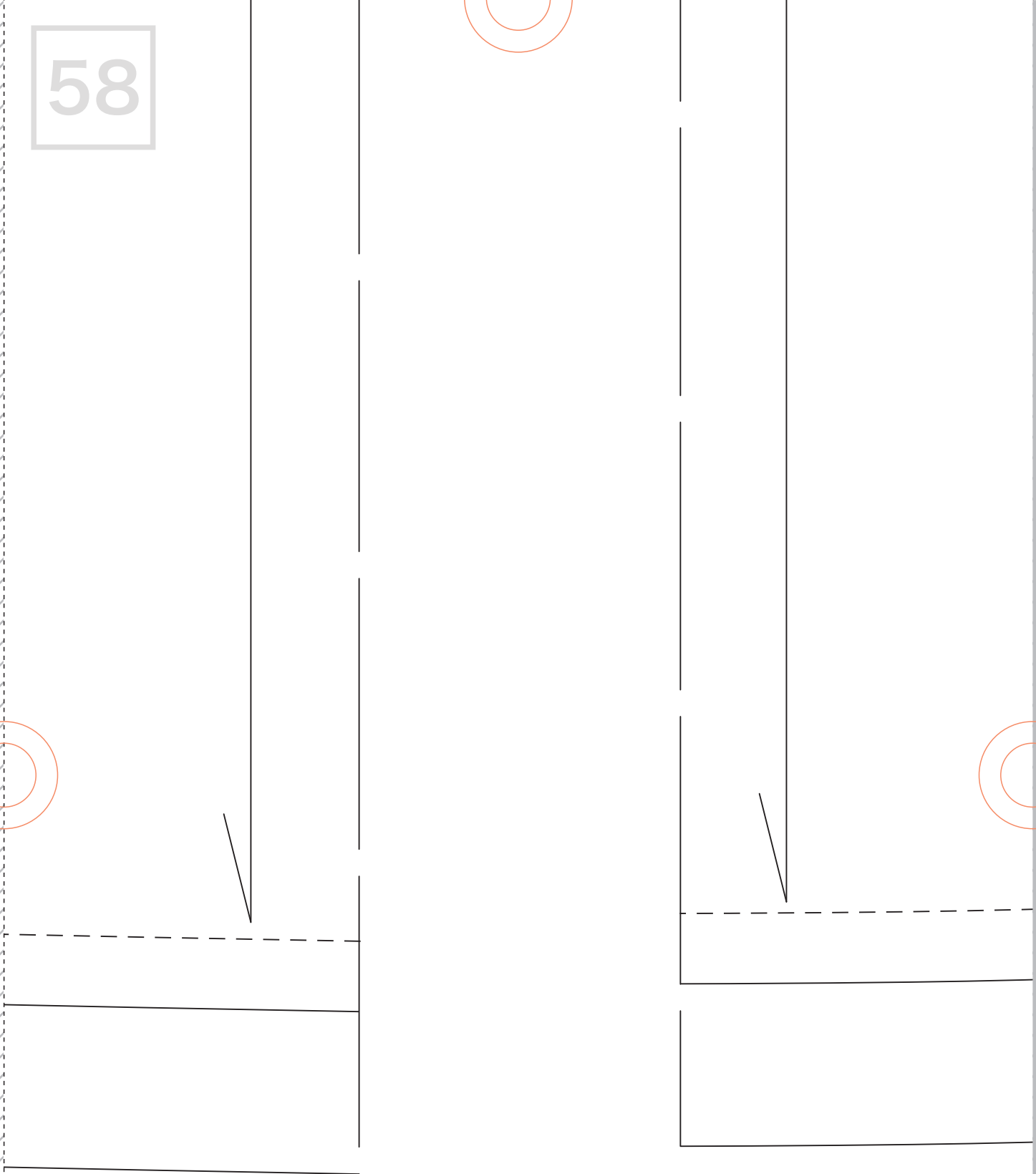
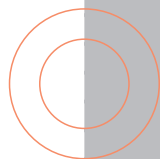
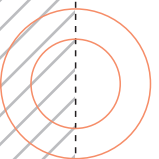
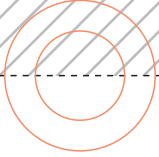

59

1.5cm幅三つ折りステッチ

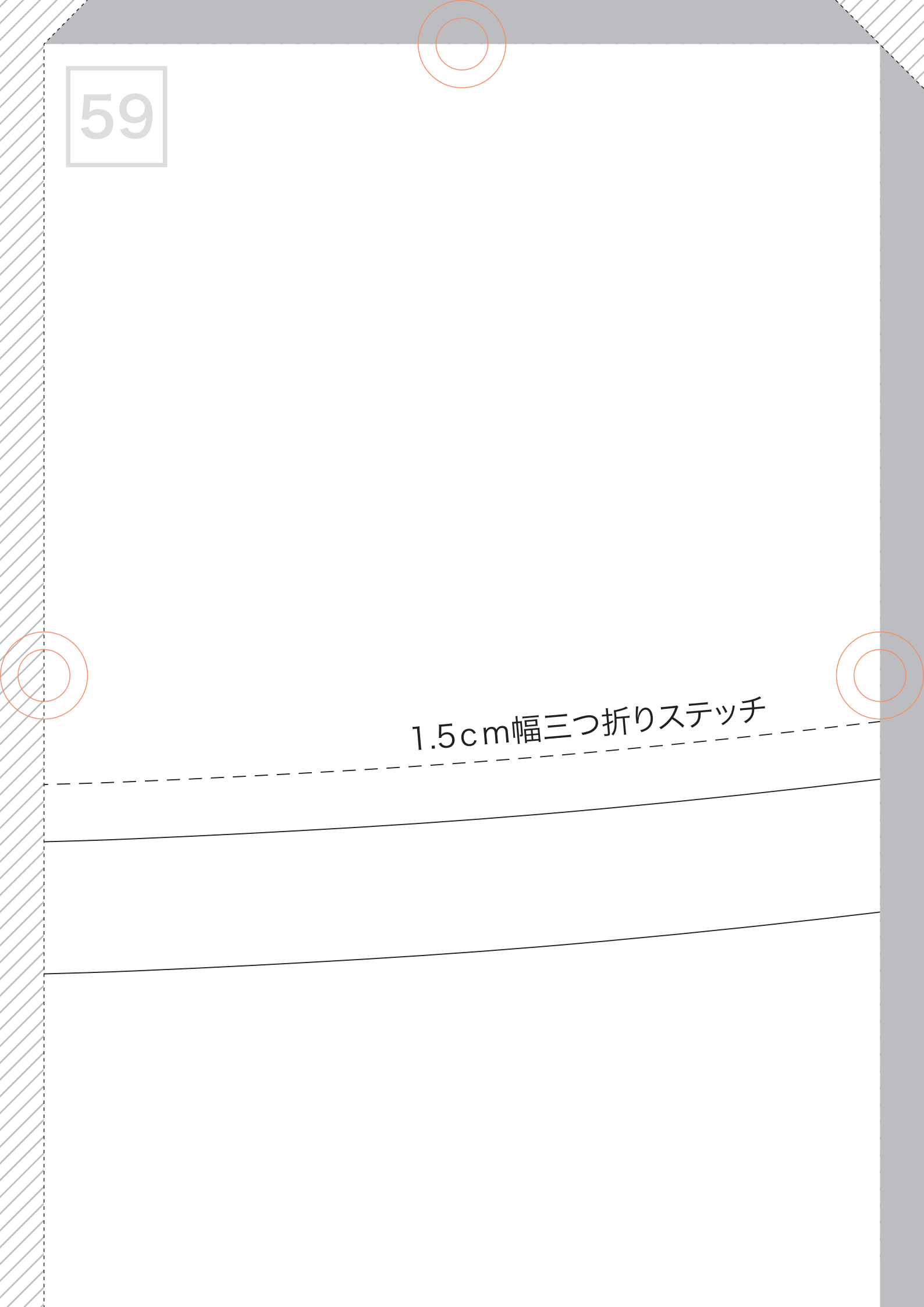

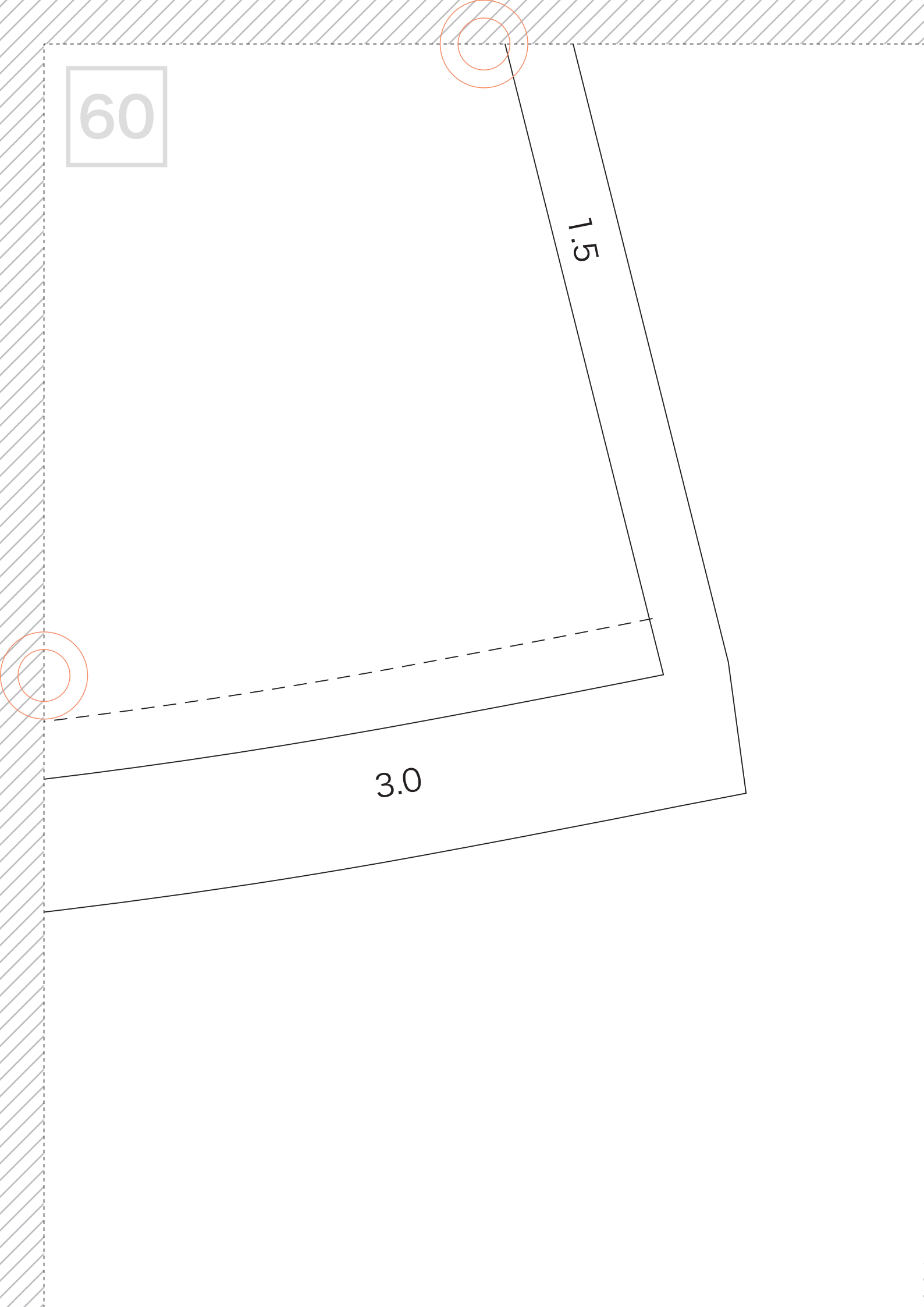

60

1.5

3.0