



introduction はじめに

パターンは A4 サイズ 33 枚に分割されています。
印刷後、右図のようにつなぎ合わせてください。

! 印刷時の注意

印刷設定では、「ページの拡大や縮小」を選択せず
必ず、「実際のサイズ」(原寸)で印刷してください。

how to make パターンのつくりかた

STEP1 斜線部分  は切り取り、灰色部分  は残してのりしろにします。
(斜線と灰色を間違えないように注意)

STEP2 各用紙の番号を確認し、 の位置を合わせて、
のりつけします。
(水のりは用紙が波打ちます。スティック糊などをお使いください)

STEP3 それぞれのパーツをハサミで切り出します。

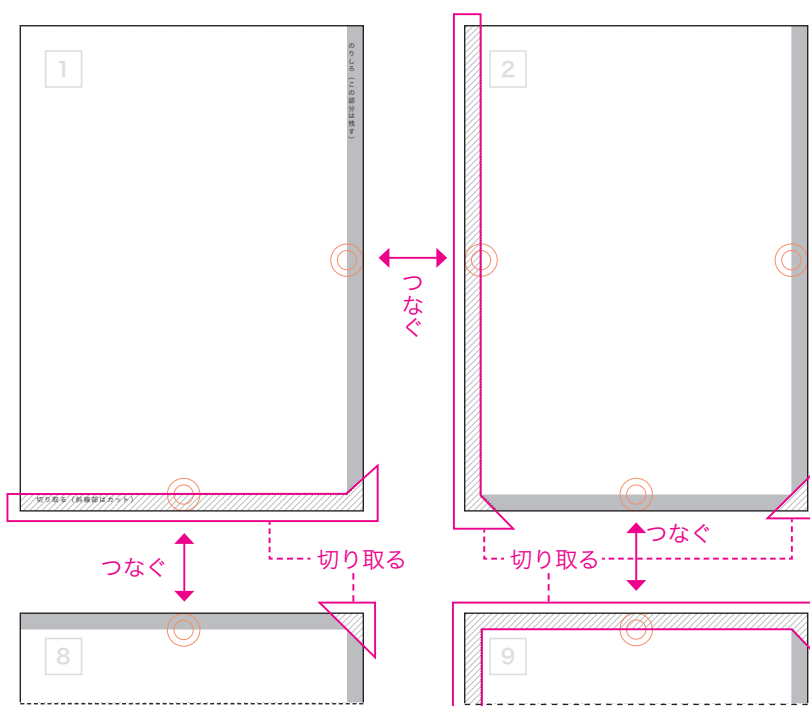
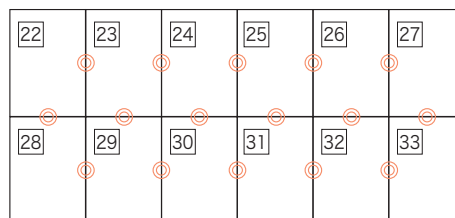
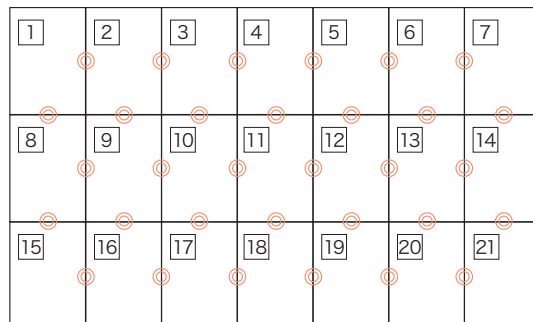

1

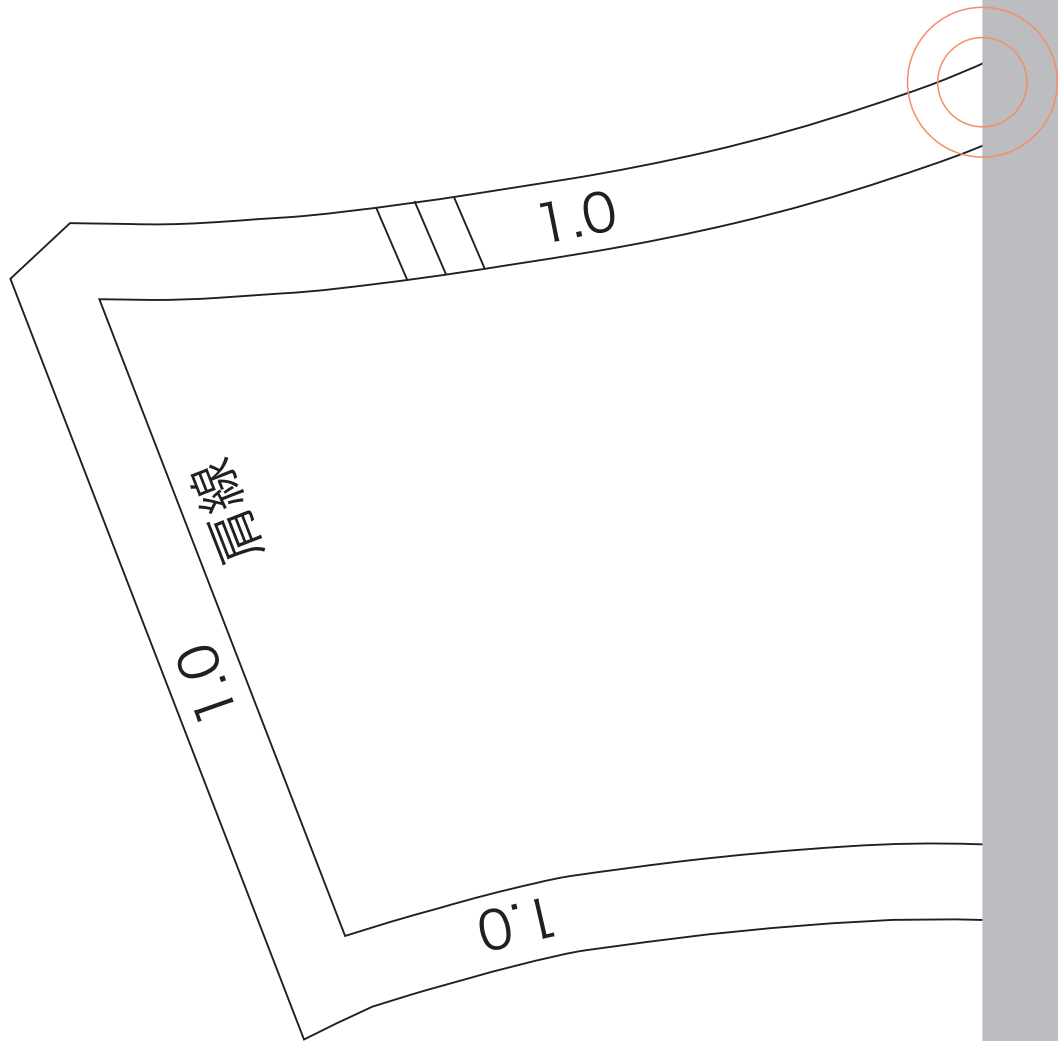

切り取る (斜線部はカット)

2

杉と接ぐ

前中心わ

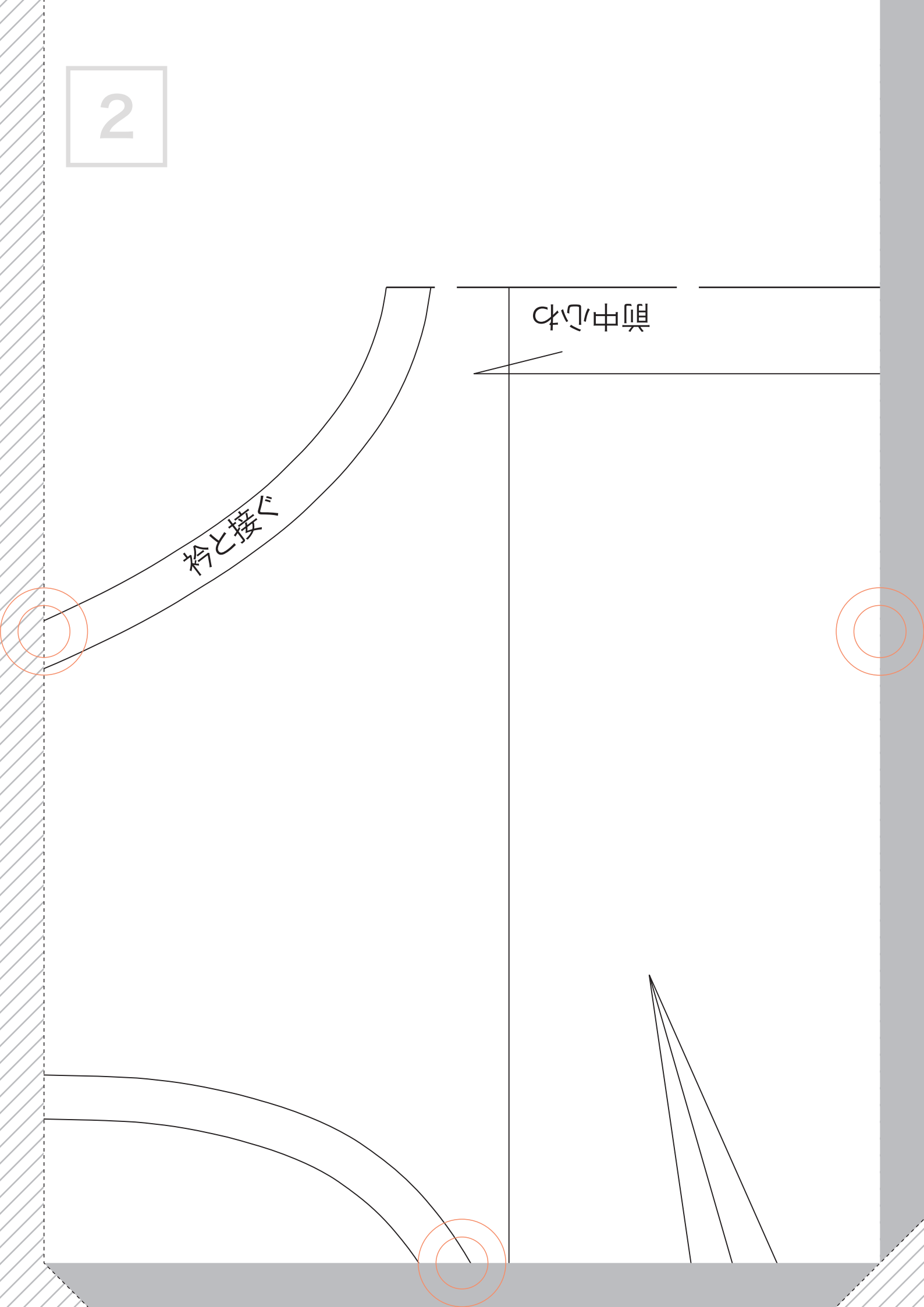

3

f a b f a b - 9

前身頃

size : 13

表×1枚

4

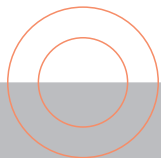
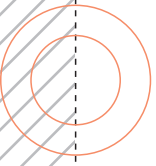

5

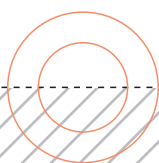
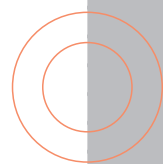
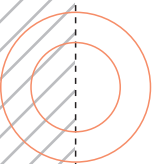

6

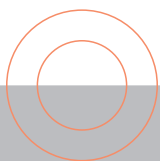
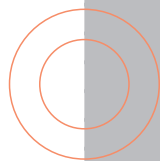
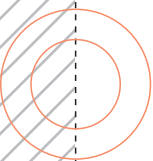

7

2.5cm三つ折りステッチ

裾線

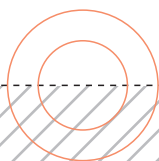
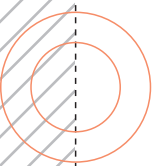

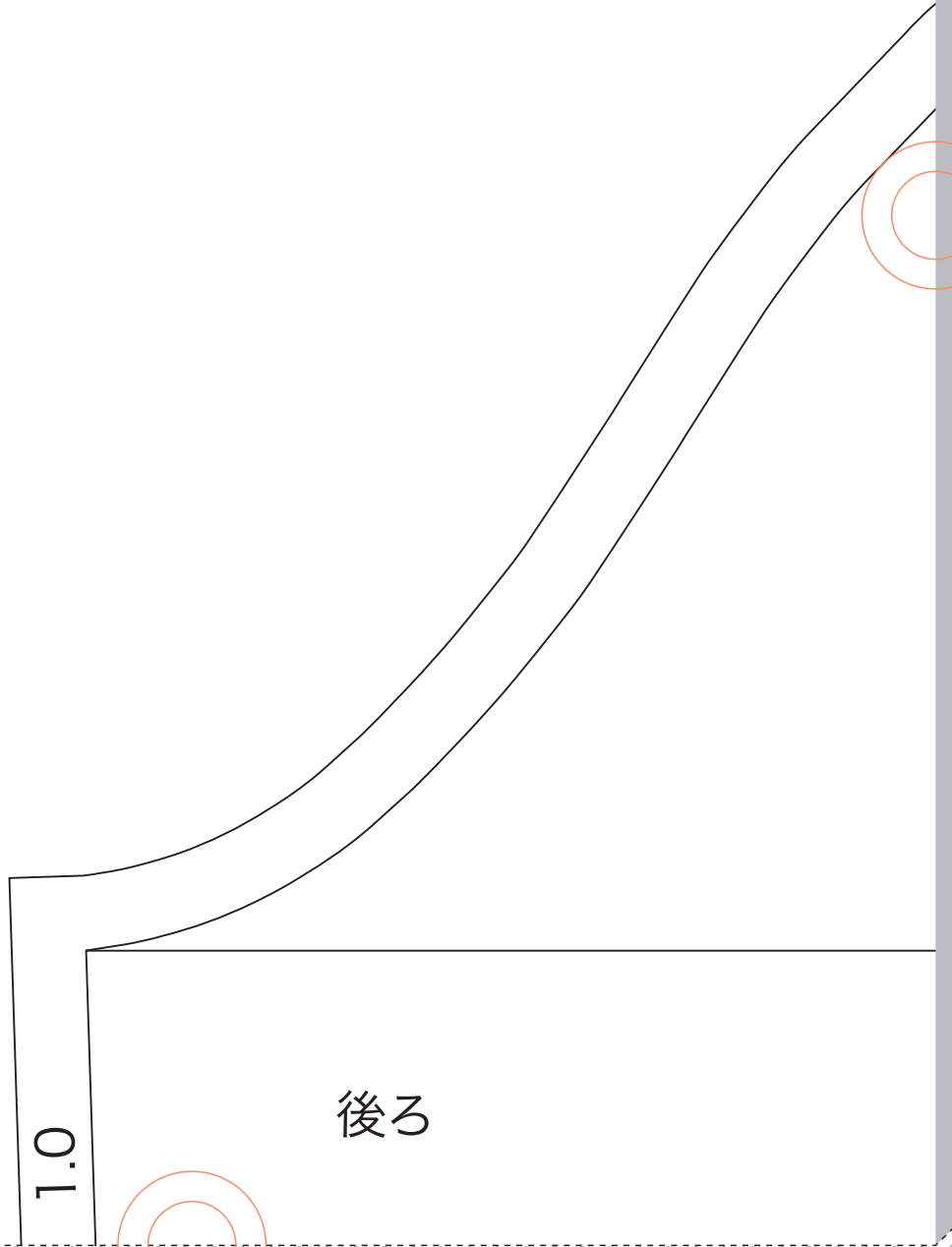
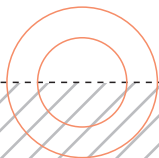
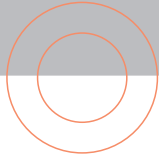

9

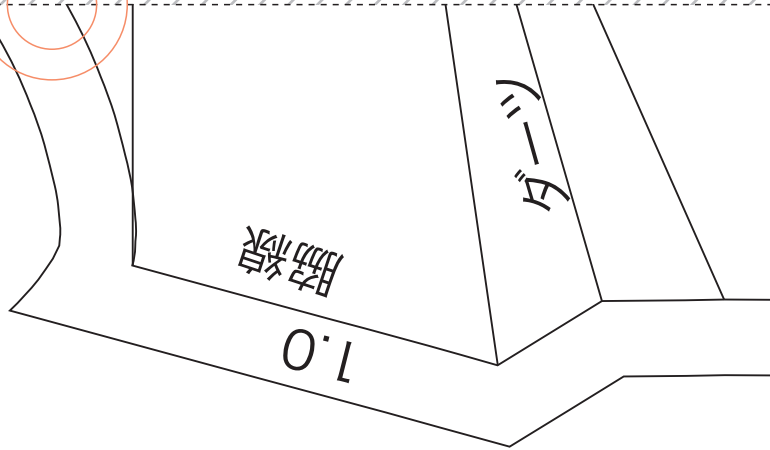
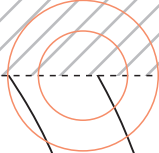

袖山

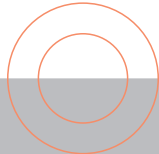
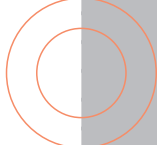
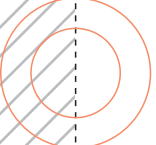

10
脇線

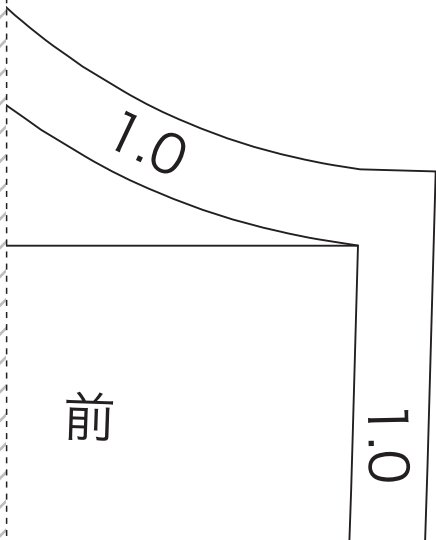
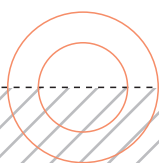
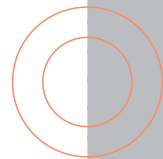
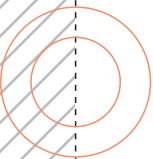
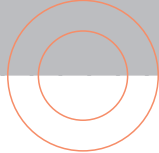

11

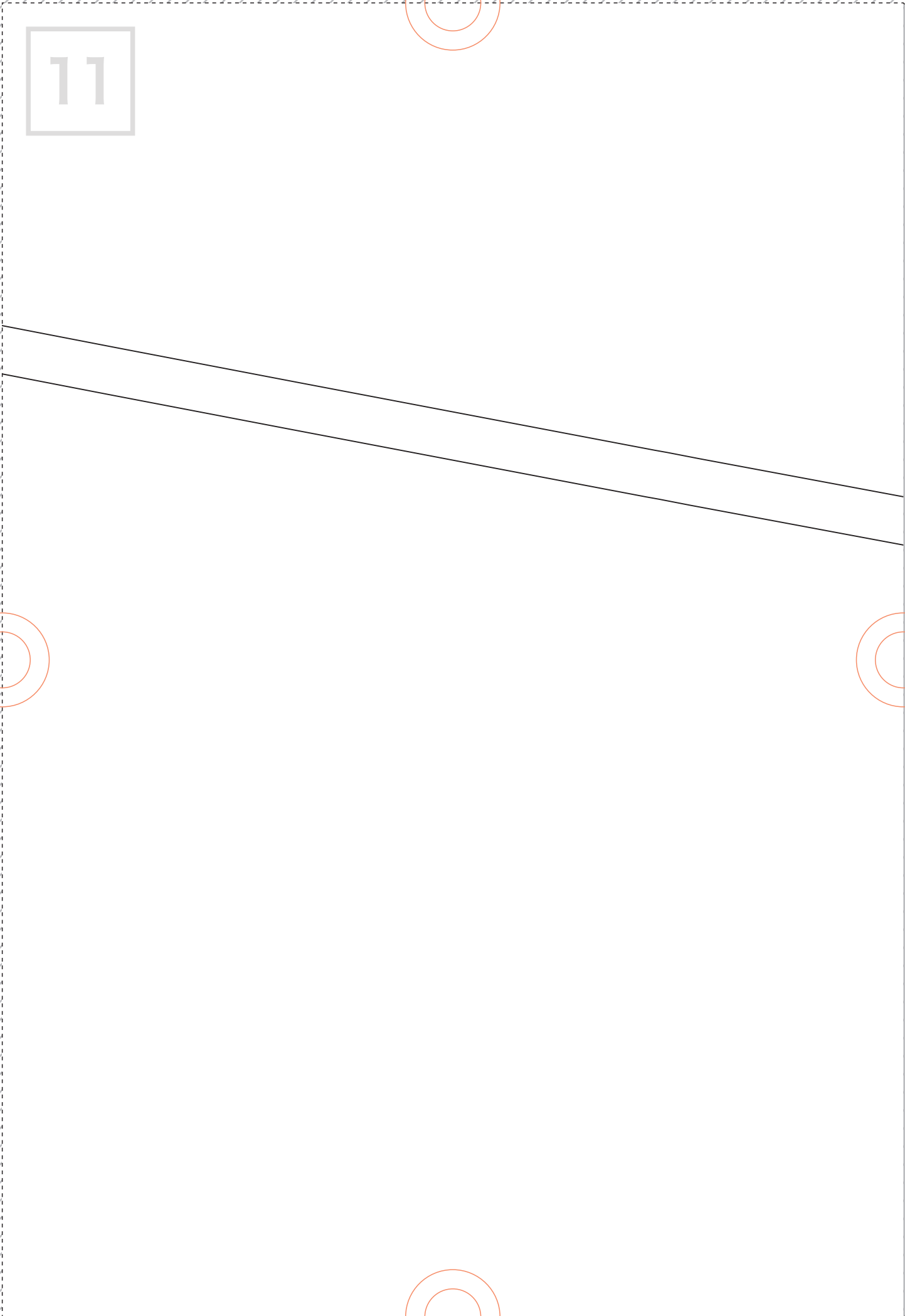
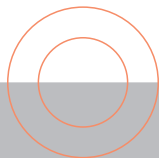
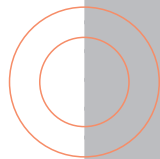
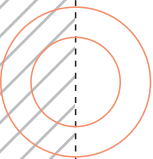
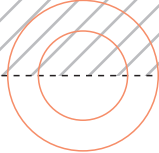

12

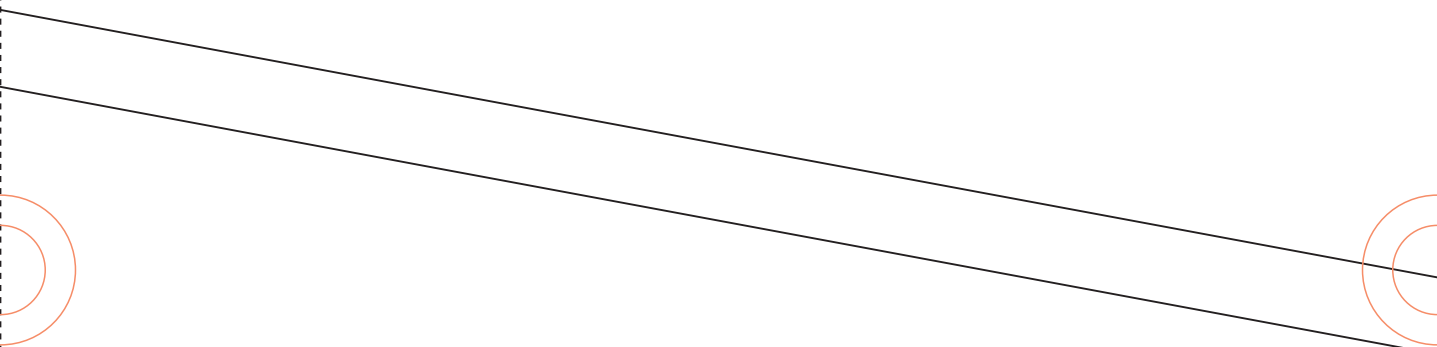
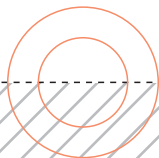
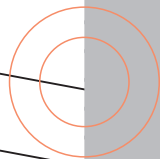
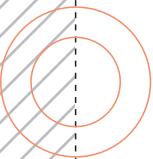
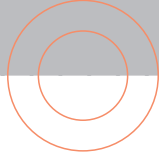

13

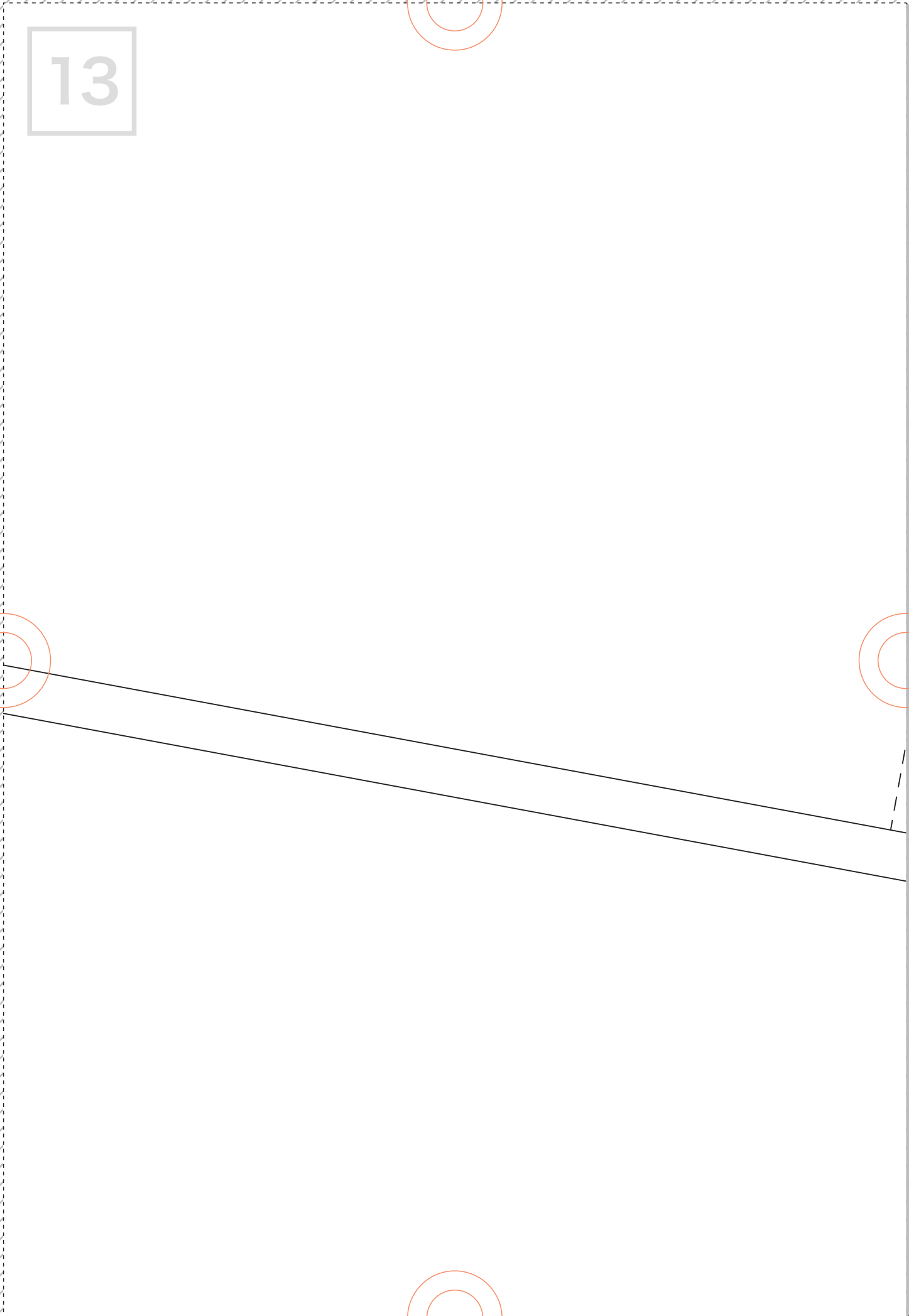
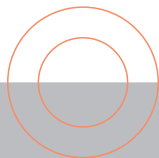
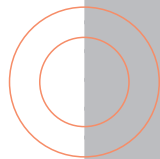
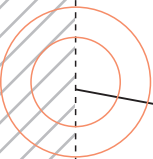
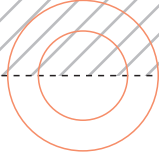

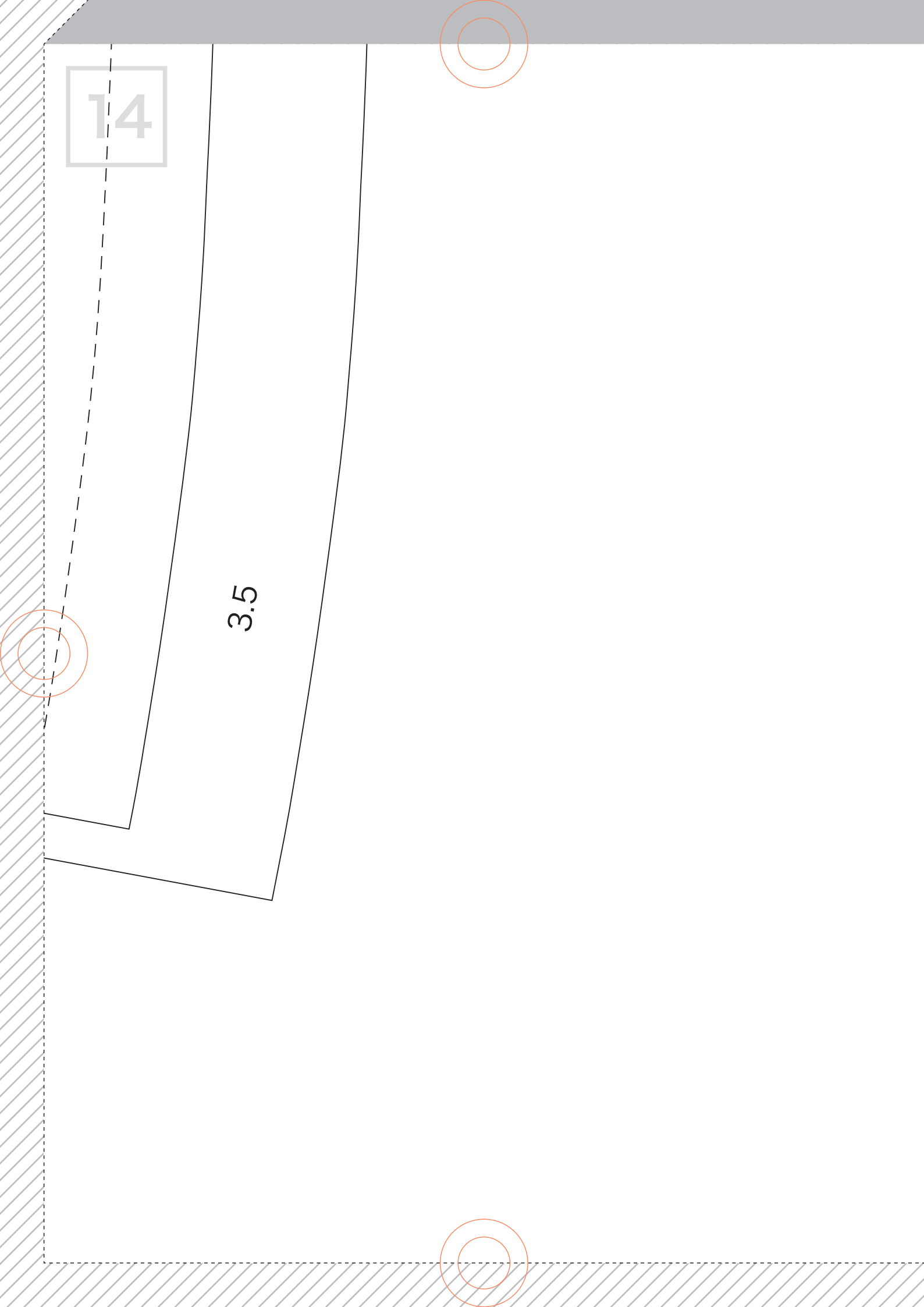

14

3.5

15

袖下

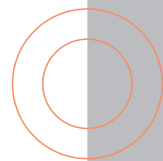
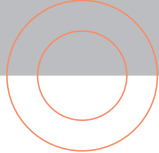

16

f a b f a b - 9

袖

size : 13

表×2枚

1.5cm三つ折りステッチ

袖口線

2.5

17

袖下

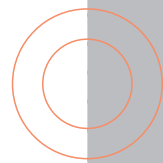
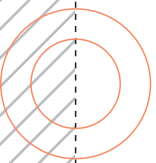
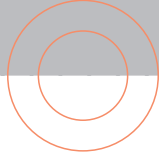

18

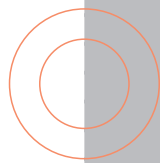
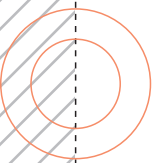
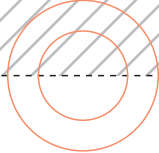

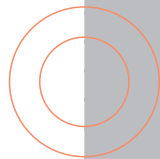
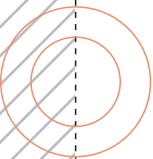
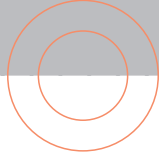

20

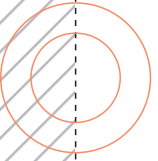
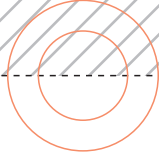

21

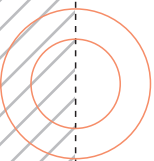
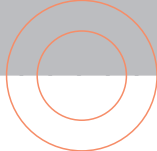

22

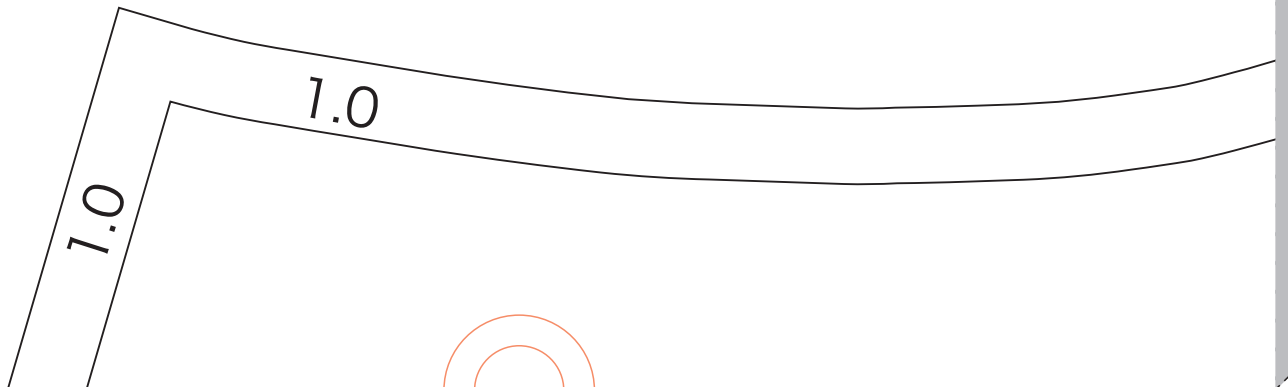

切り取る (斜線部はカット)

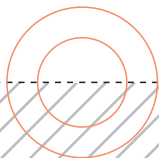

23

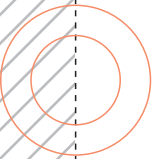

1.0

脇線

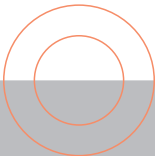

24

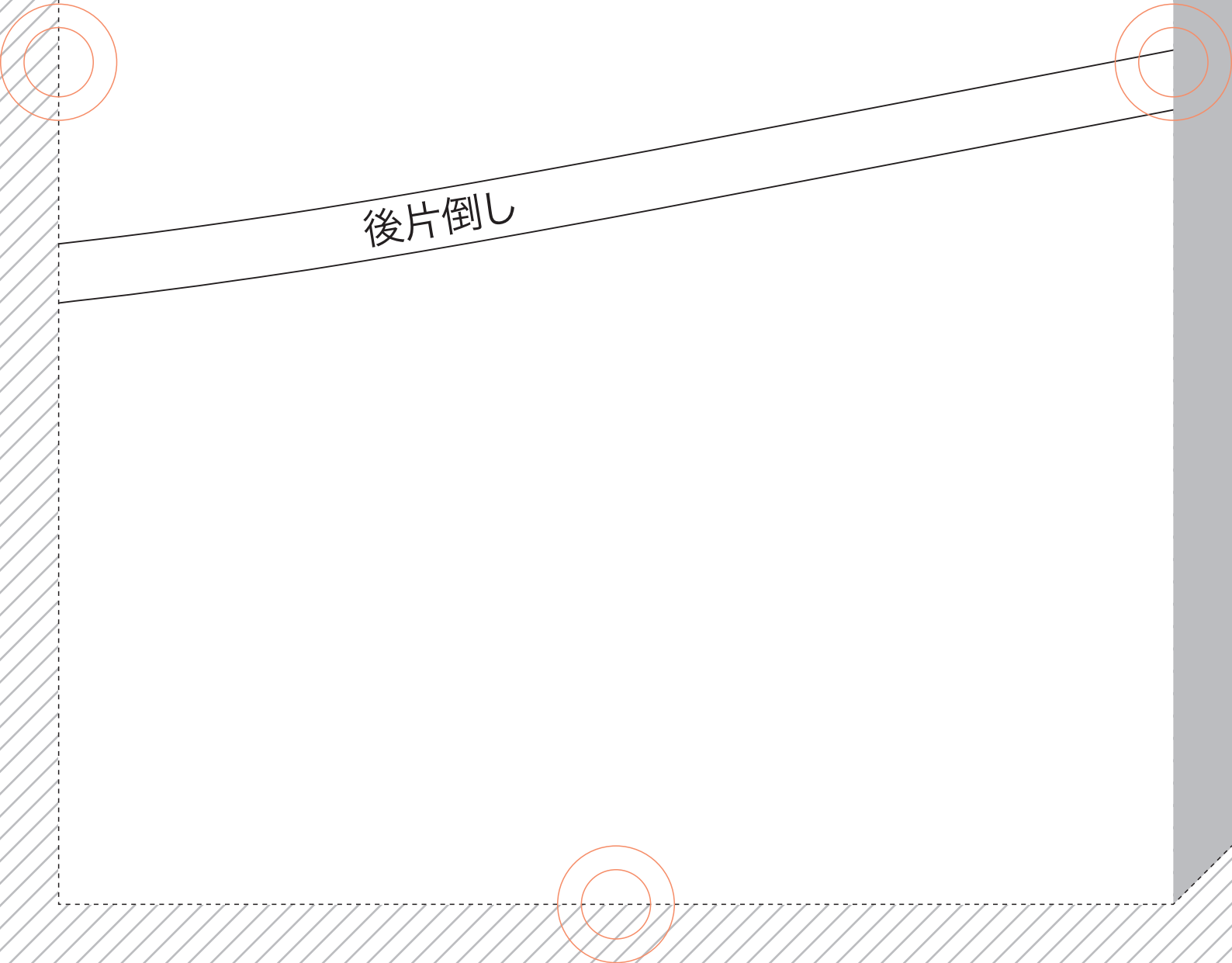

25

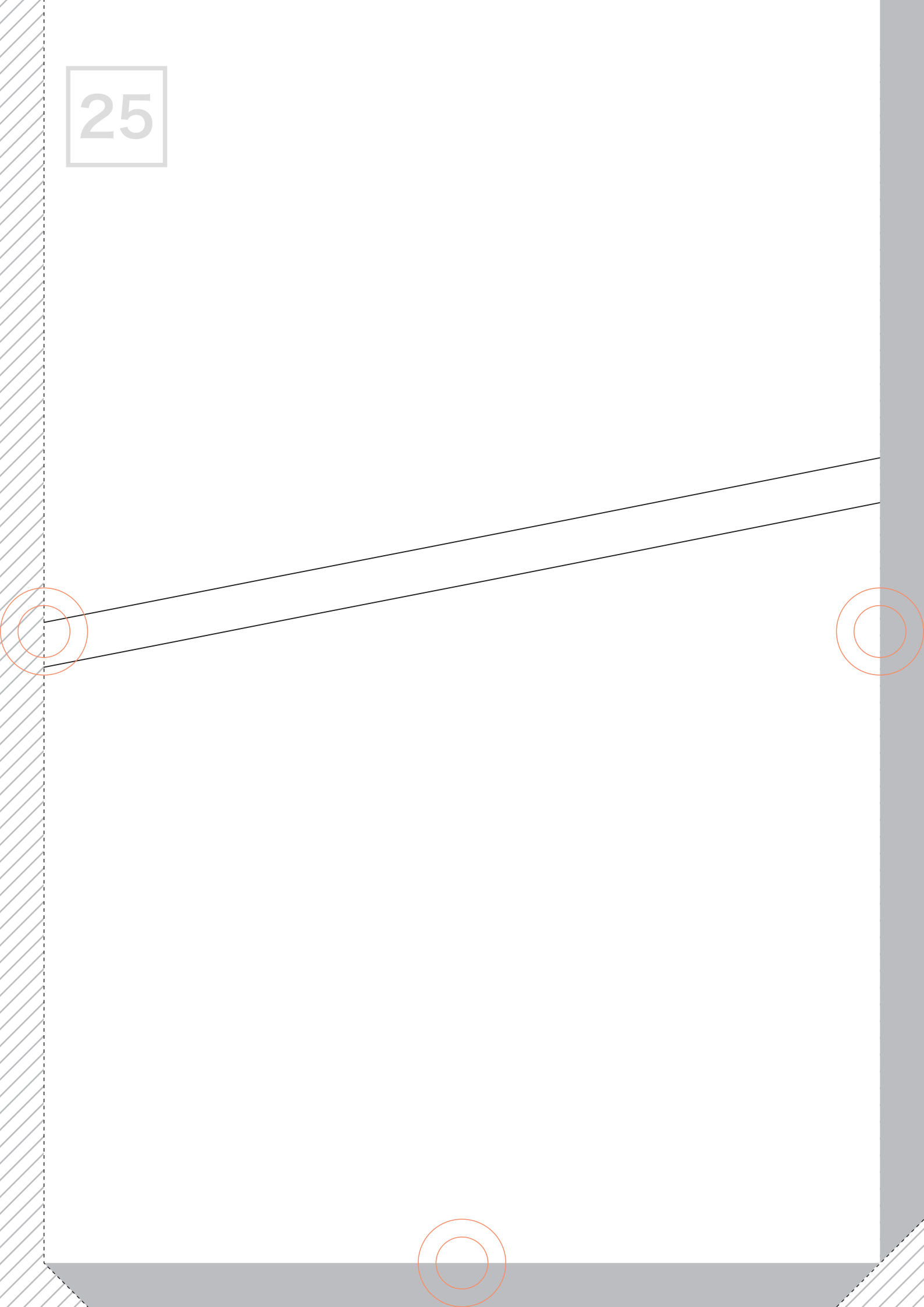

26

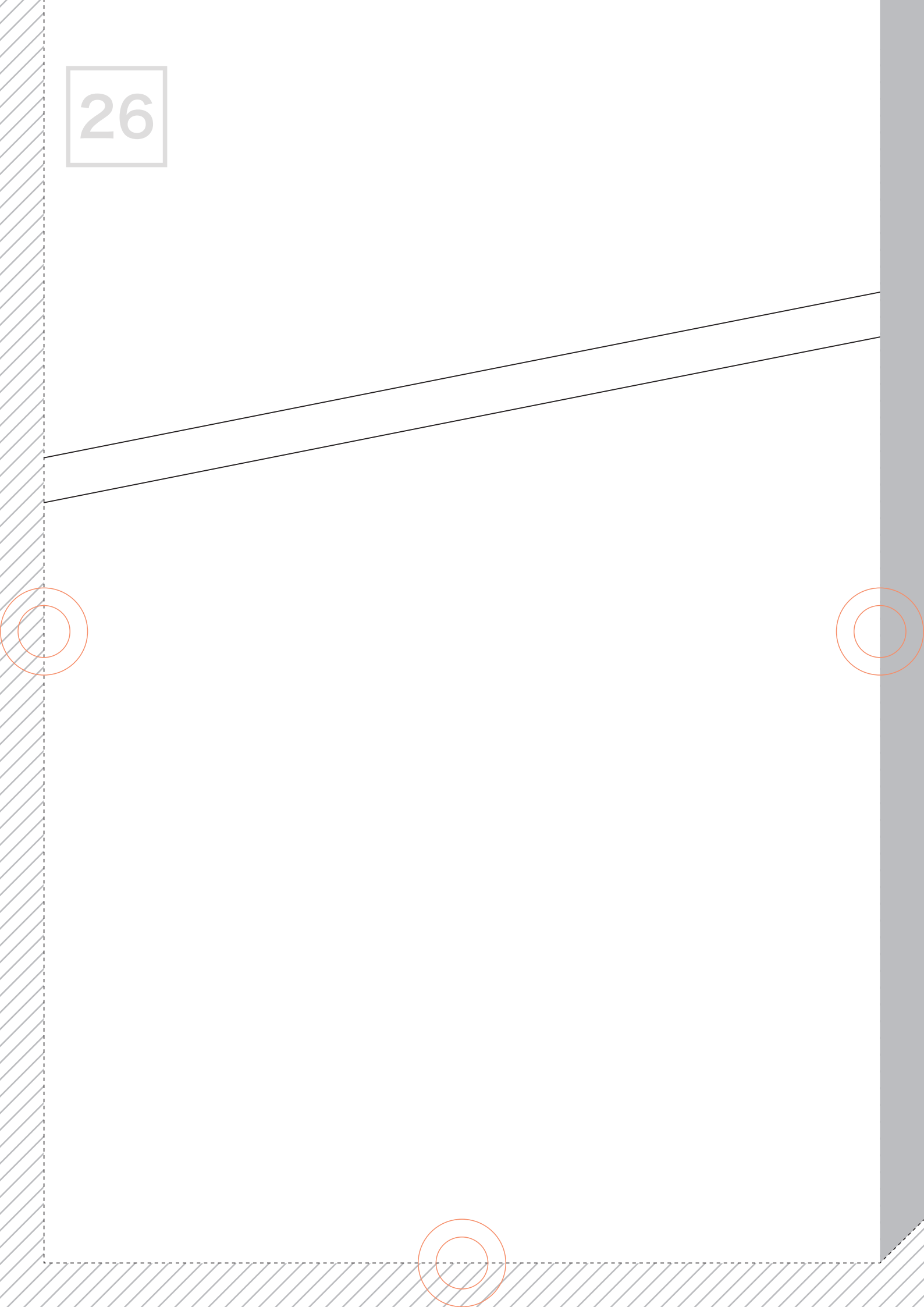

27

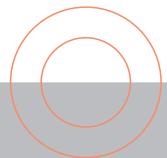
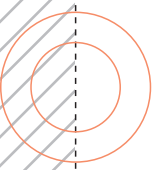

2.5cm三つ折りステッチ

3.5

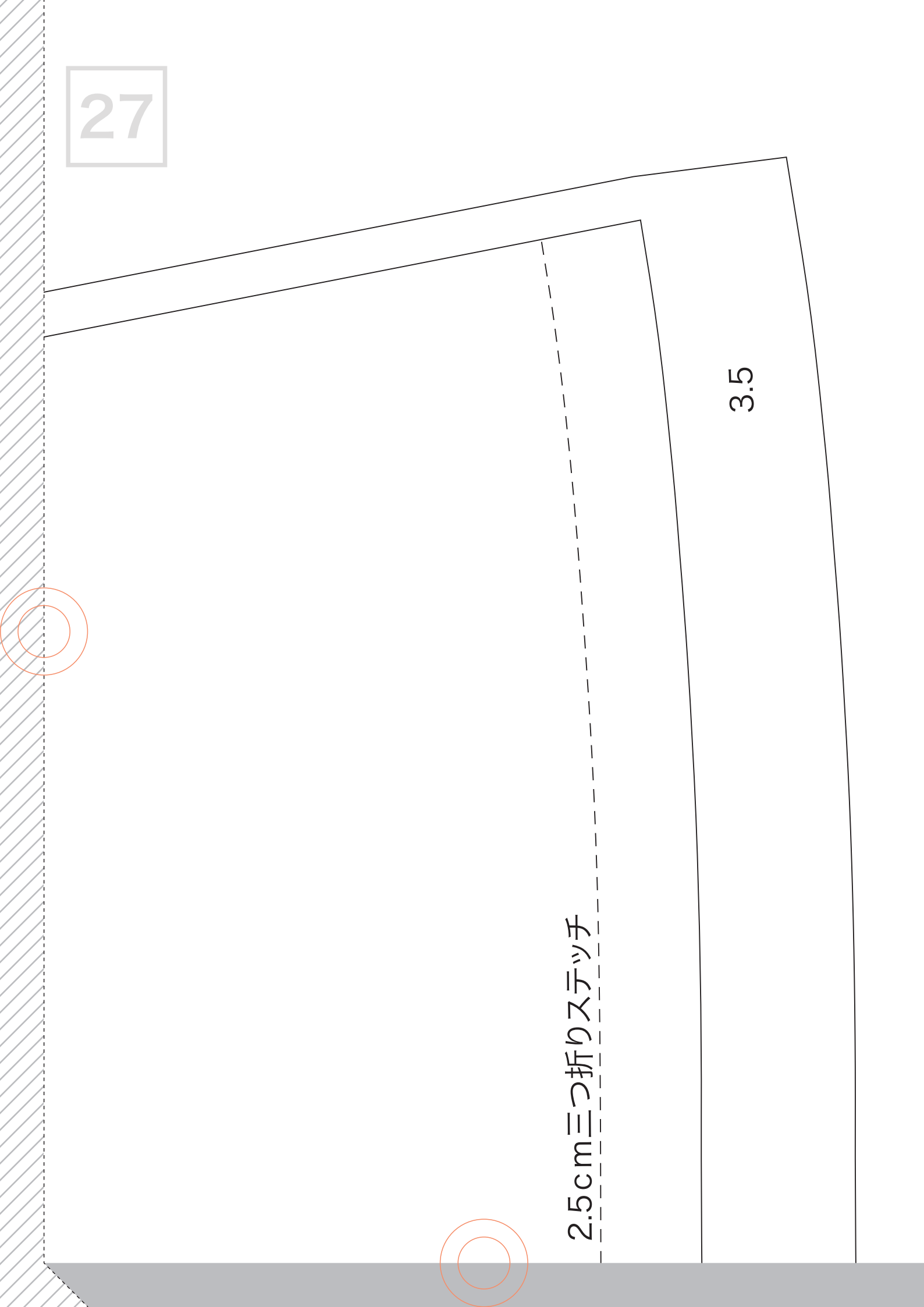

28

肩線

1.0

衿と接ぐ

後ろ中心わ

1.0

左肩

29

f a b f a b - 9

後身頃

size : 13

表×1枚

π . C

30

f a b f a b - 9

衿

折山線

size : 13

表 × 1 枚

○ 右肩

31

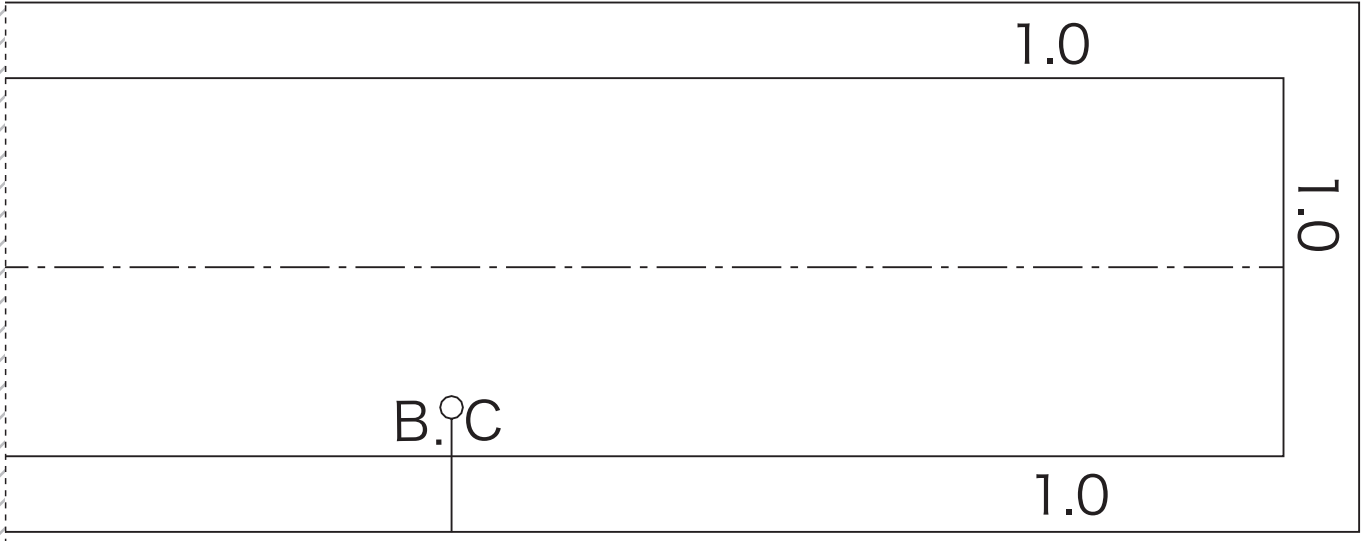
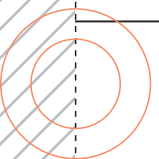
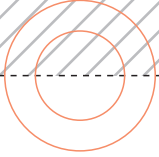

B.C

1.0

1.0

1.0

32

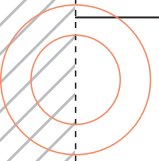
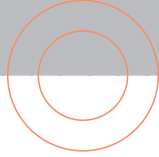

33

裾線

