



introduction はじめに

パターンは A4 サイズ 33 枚に分割されています。
印刷後、右図のようにつなぎ合わせてください。

! 印刷時の注意

印刷設定では、「ページの拡大や縮小」を選択せず
必ず、「実際のサイズ」(原寸)で印刷してください。

how to make パターンのつくりかた

STEP1 斜線部分  は切り取り、灰色部分  は残してのりしろにします。
(斜線と灰色を間違えないように注意)

STEP2 各用紙の番号を確認し、 の位置を合わせて、
のりつけします。
(水のりは用紙が波打ちます。スティック糊などをお使いください)

STEP3 それぞれのパーツをハサミで切り出します。

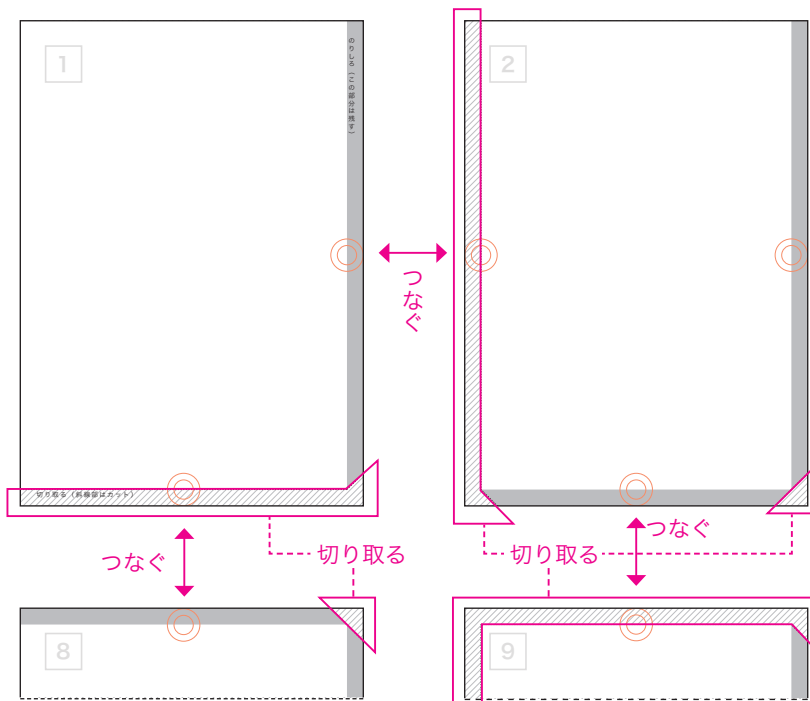
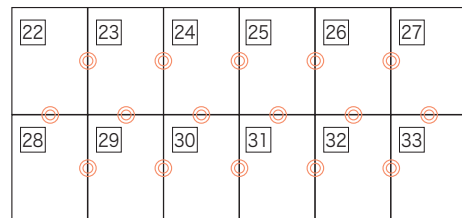
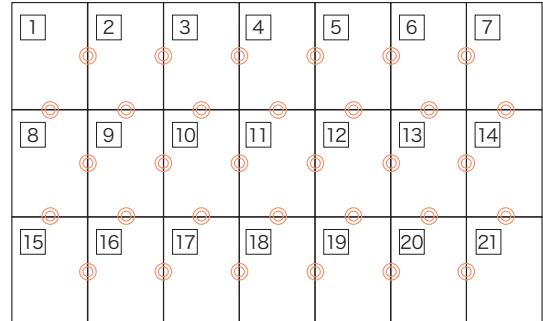

1

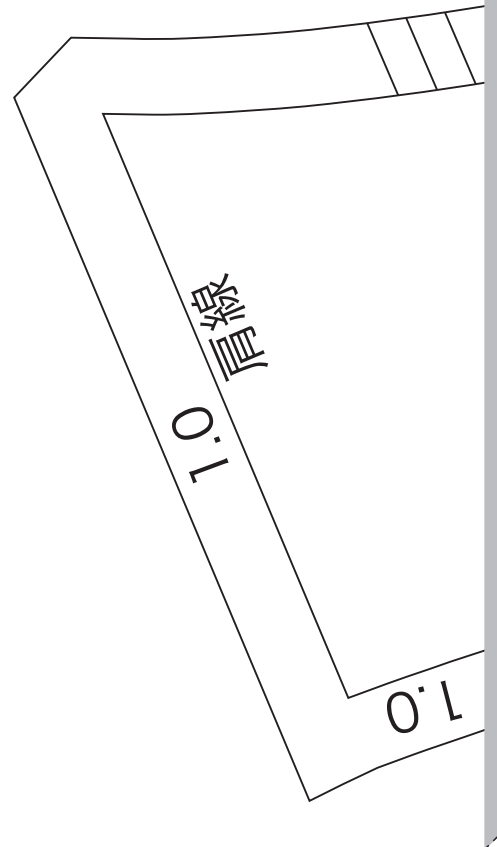

切り取る (斜線部はカット)

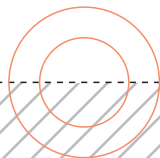

2

衿と接ぐ

1.0

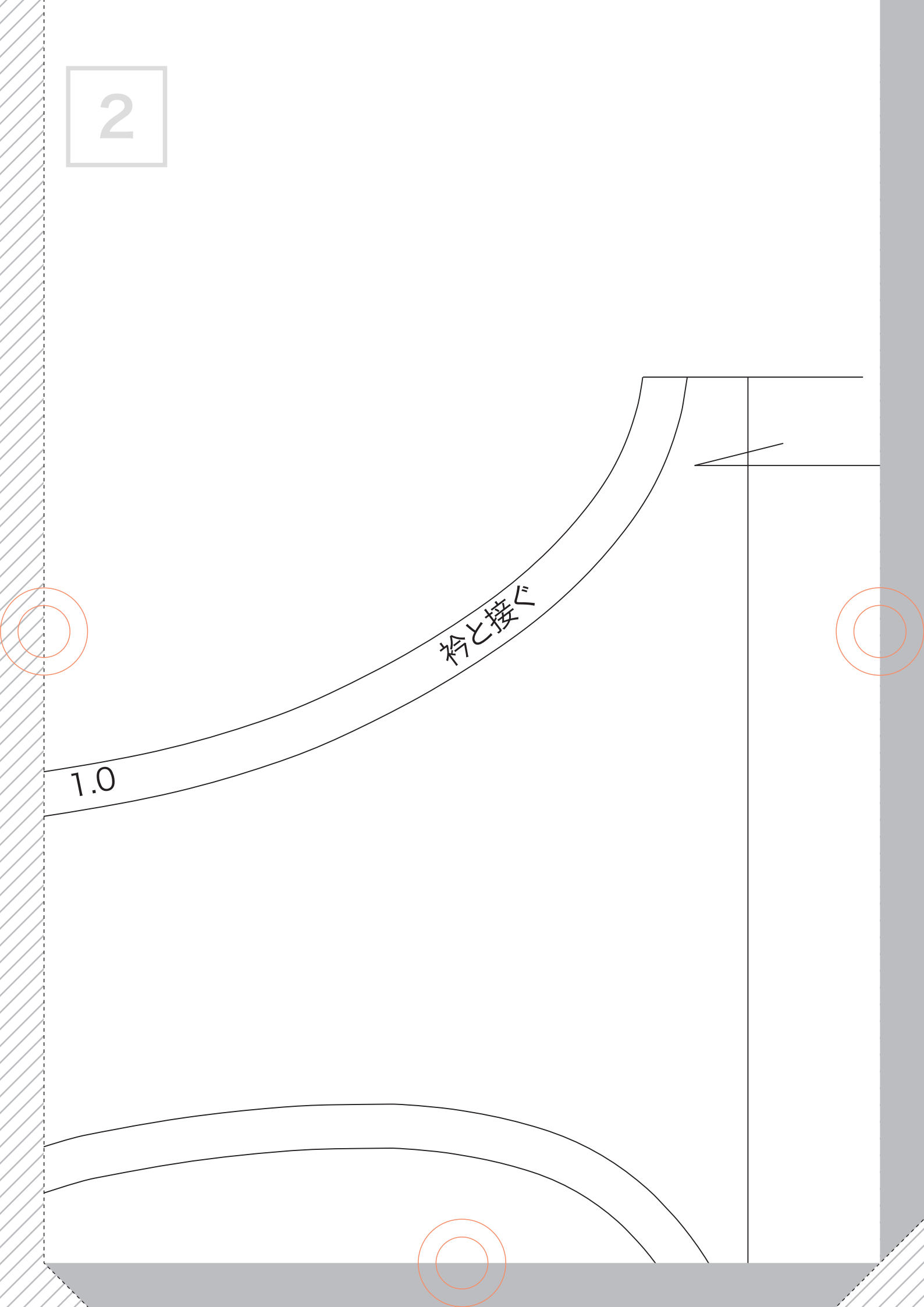

3

前中心折

f a b f a b - 9

前身頃

size : 9

表×1枚

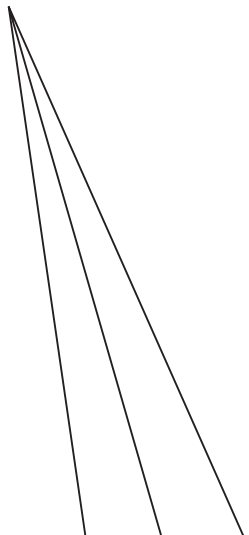
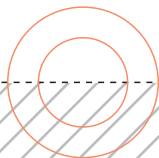
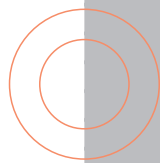
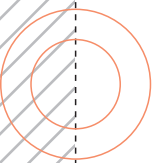

4

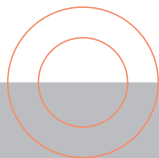
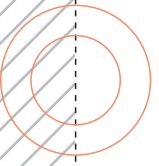

5

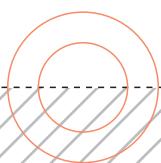
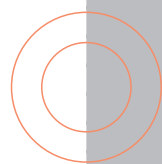
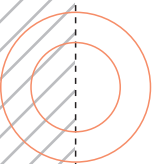

6

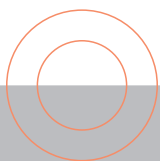
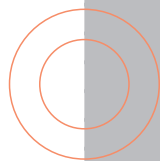
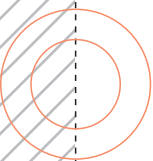

7

2.5cm三つ折りステッチ

裾線

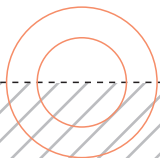
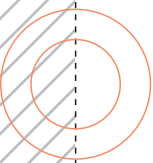

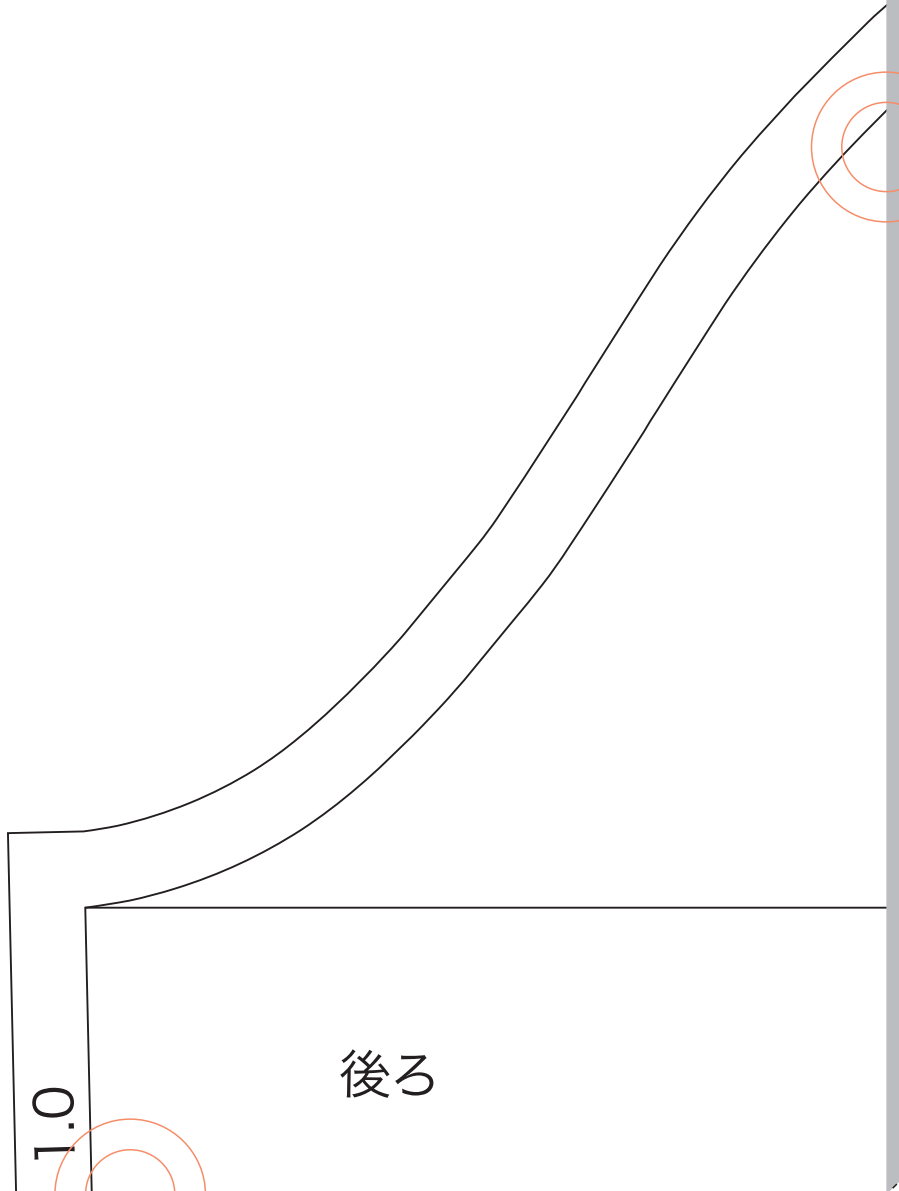
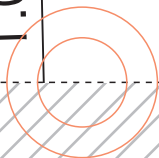
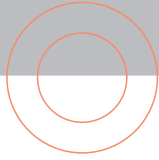

1.0

後ろ

9

脇線

1.0

袖山

前

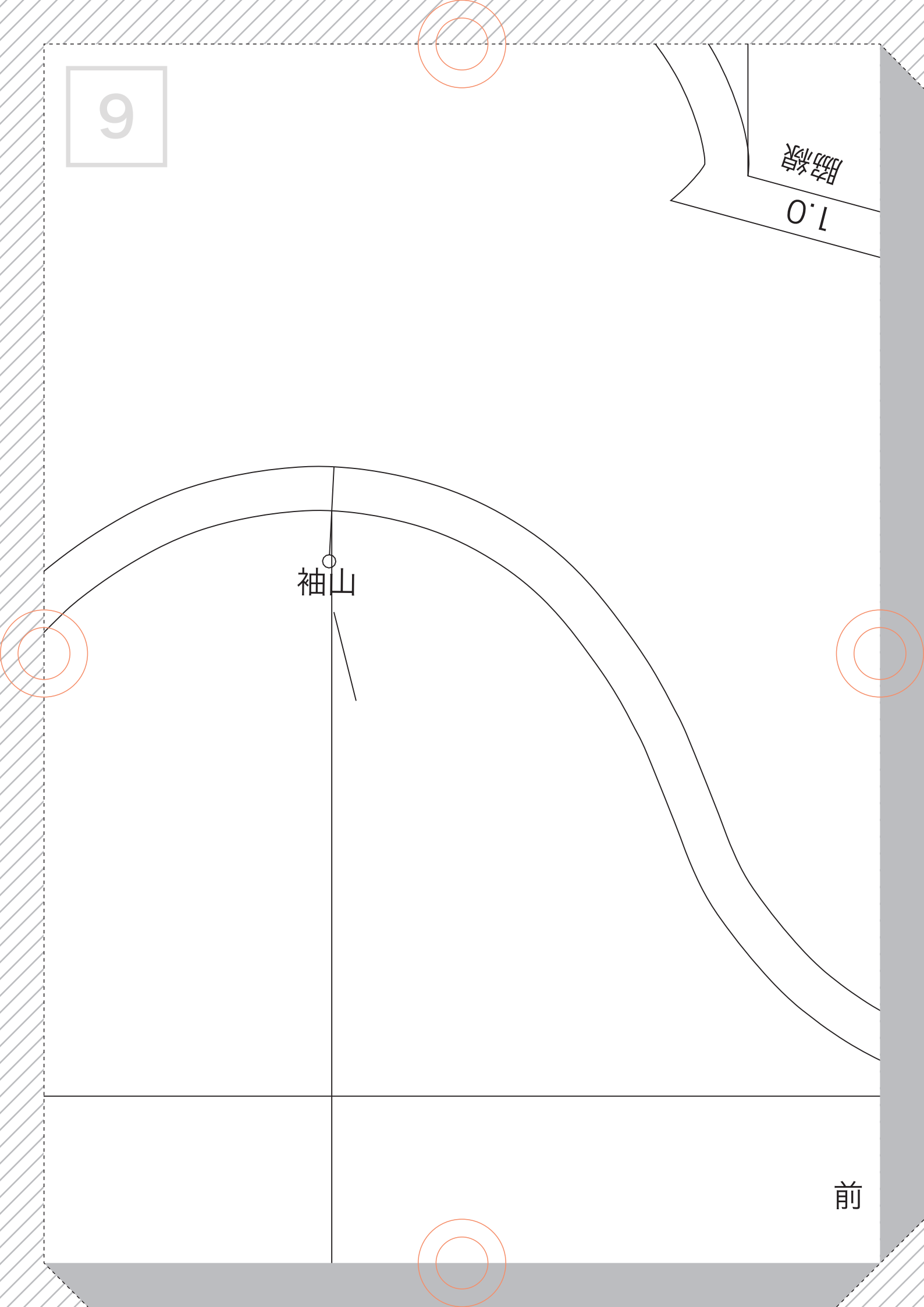



脇線

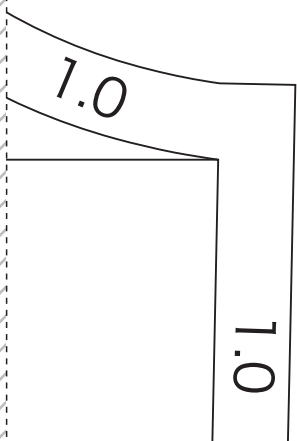
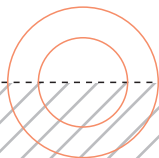
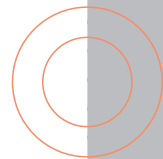
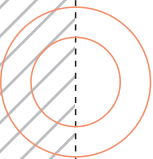
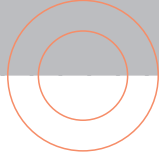

11

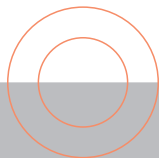
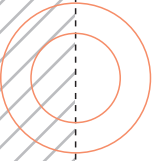
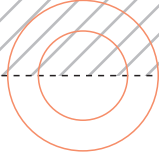

12

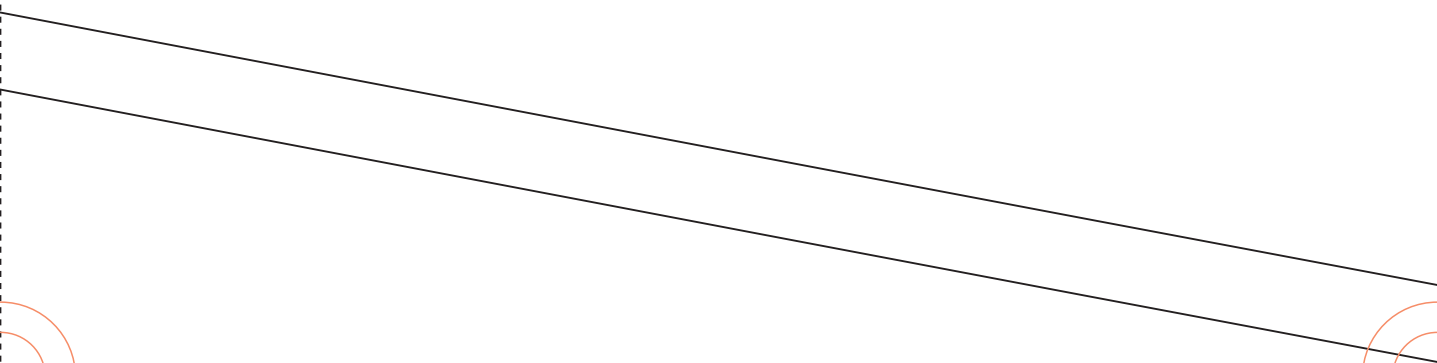
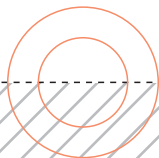
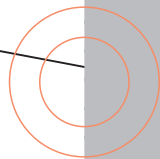
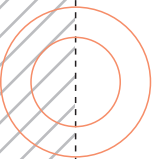
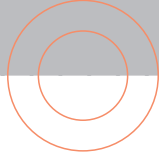

13

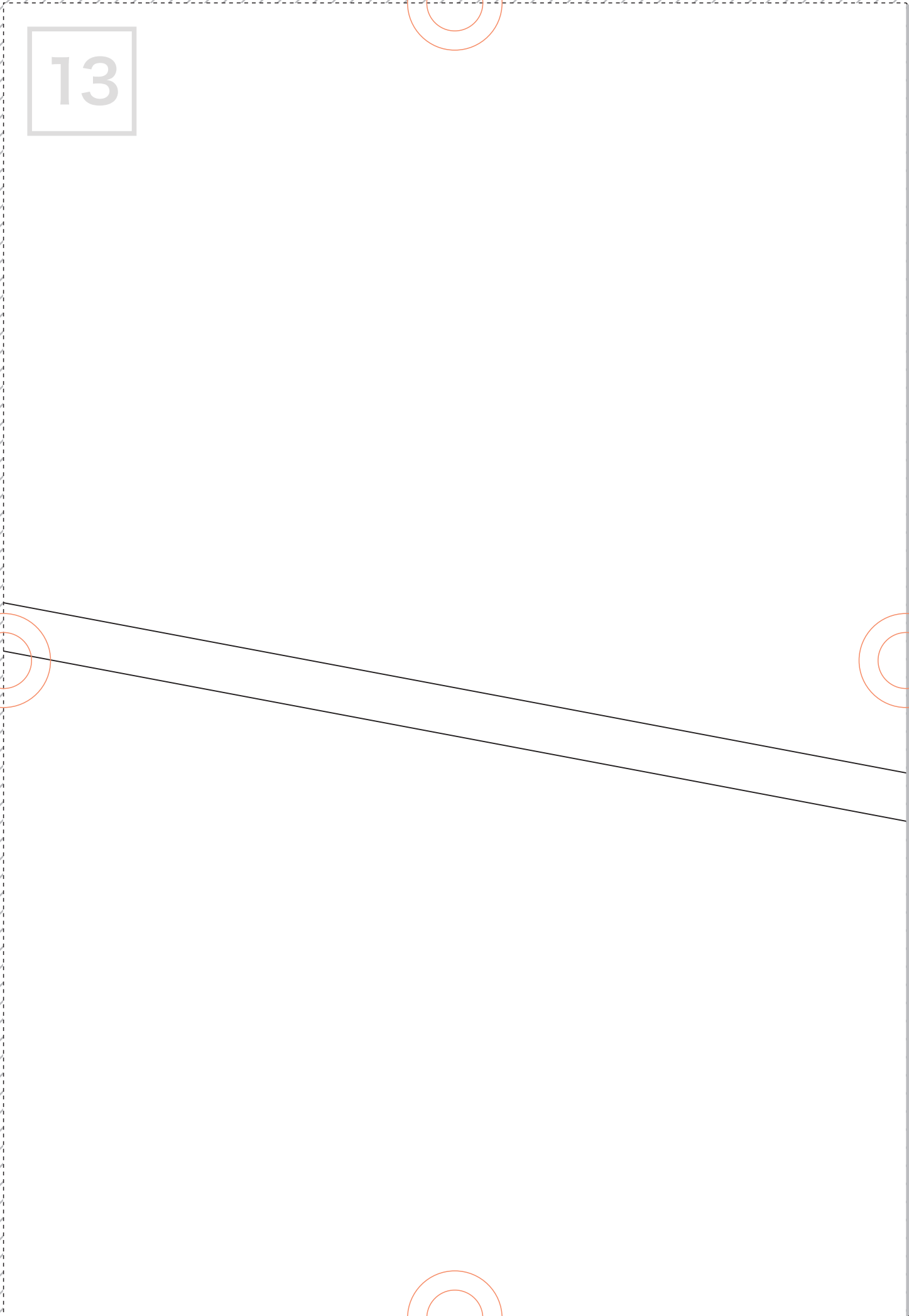
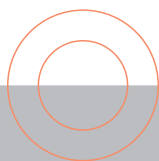
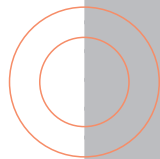
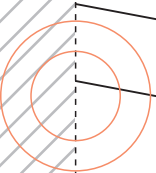
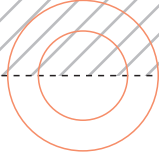

14

3.5

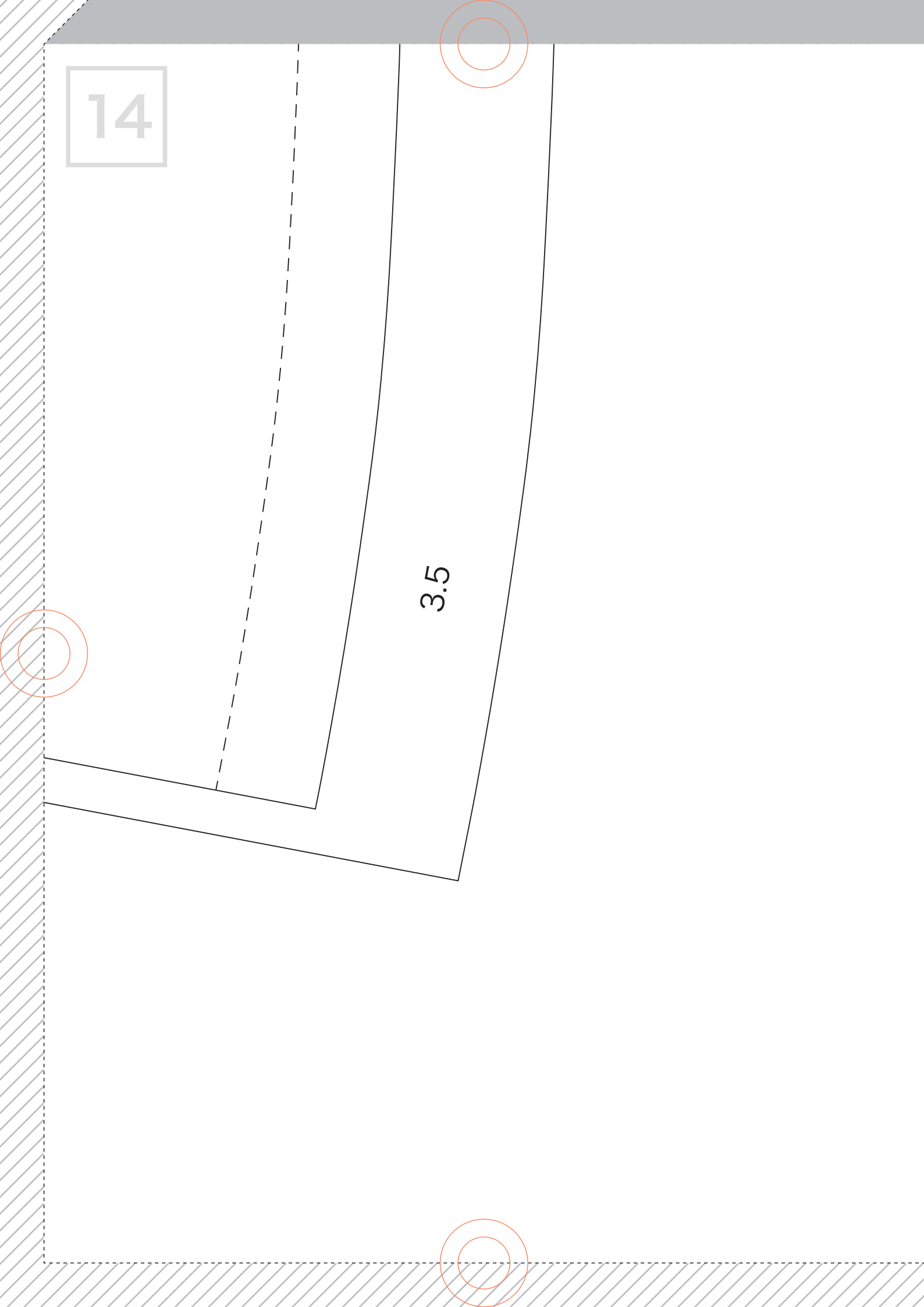

15

袖下

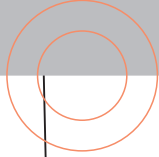

16

f a b f a b - 9

袖

size : 9

表×2枚

1.5cm三つ折りステッチ

袖口線

2.5

17

袖下

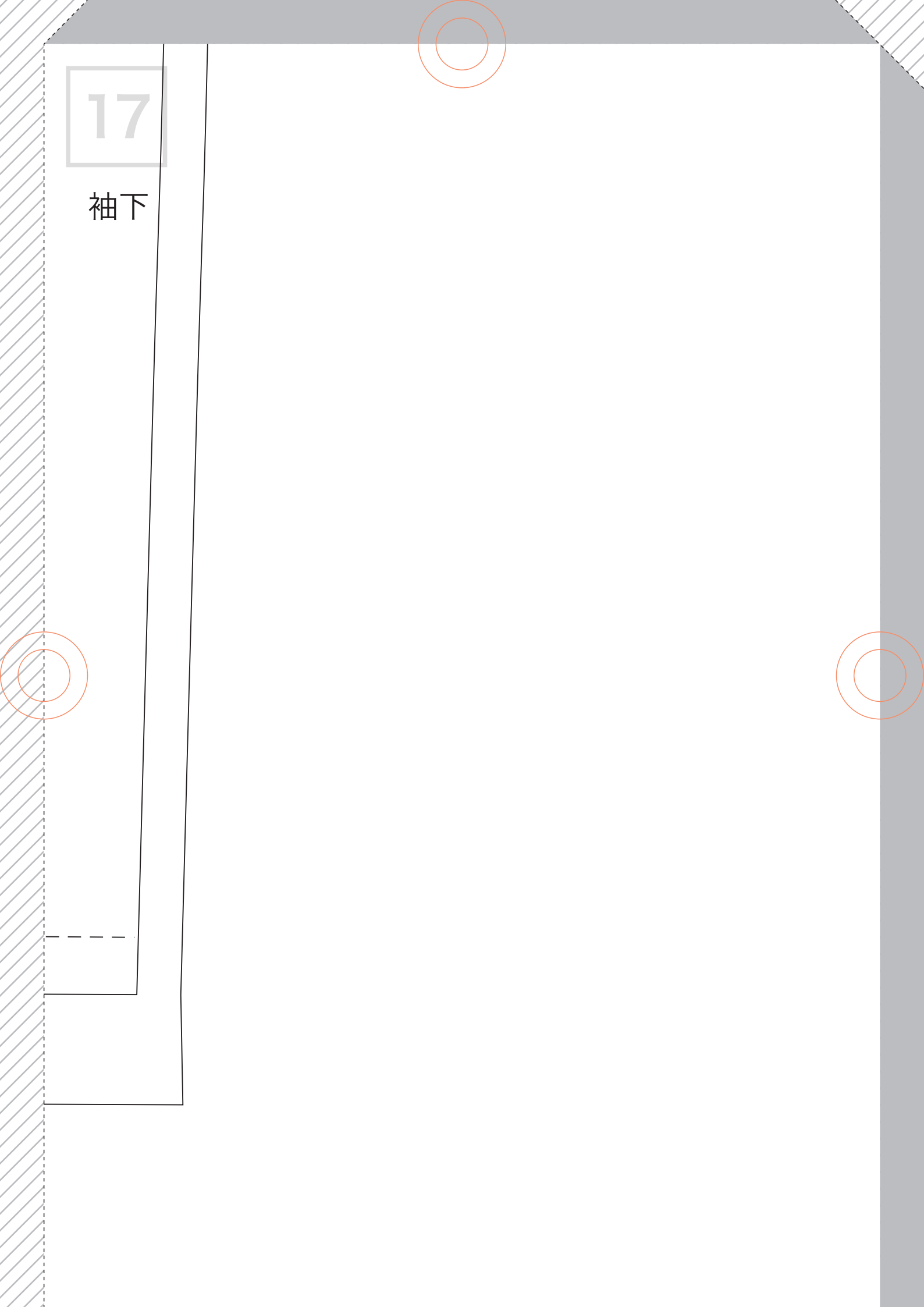

18

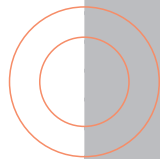
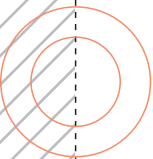
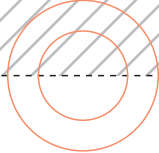

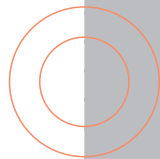
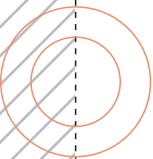
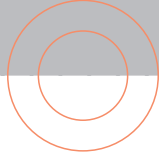

20

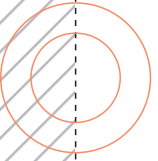
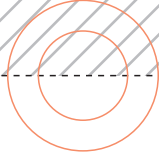

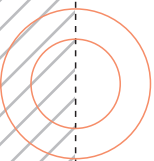
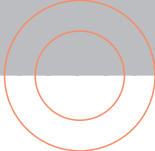

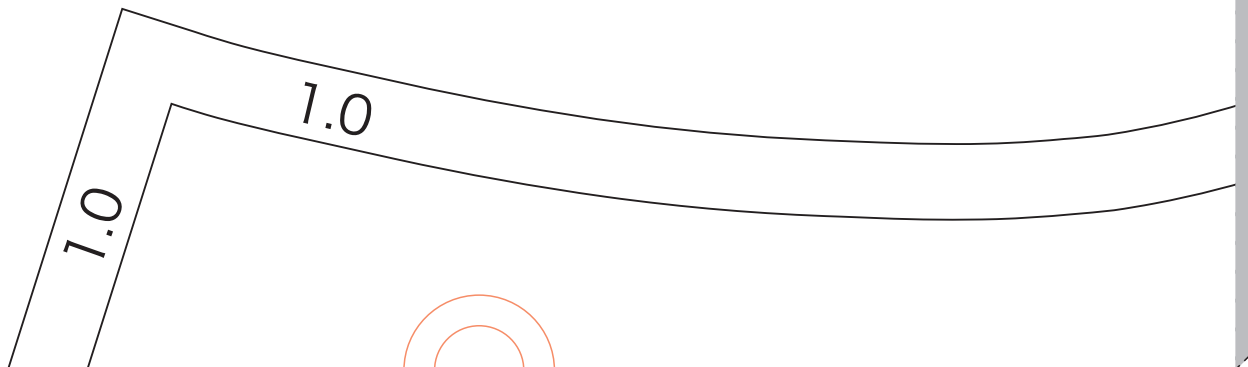

切り取る (斜線部はカット)

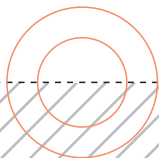

23

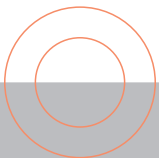
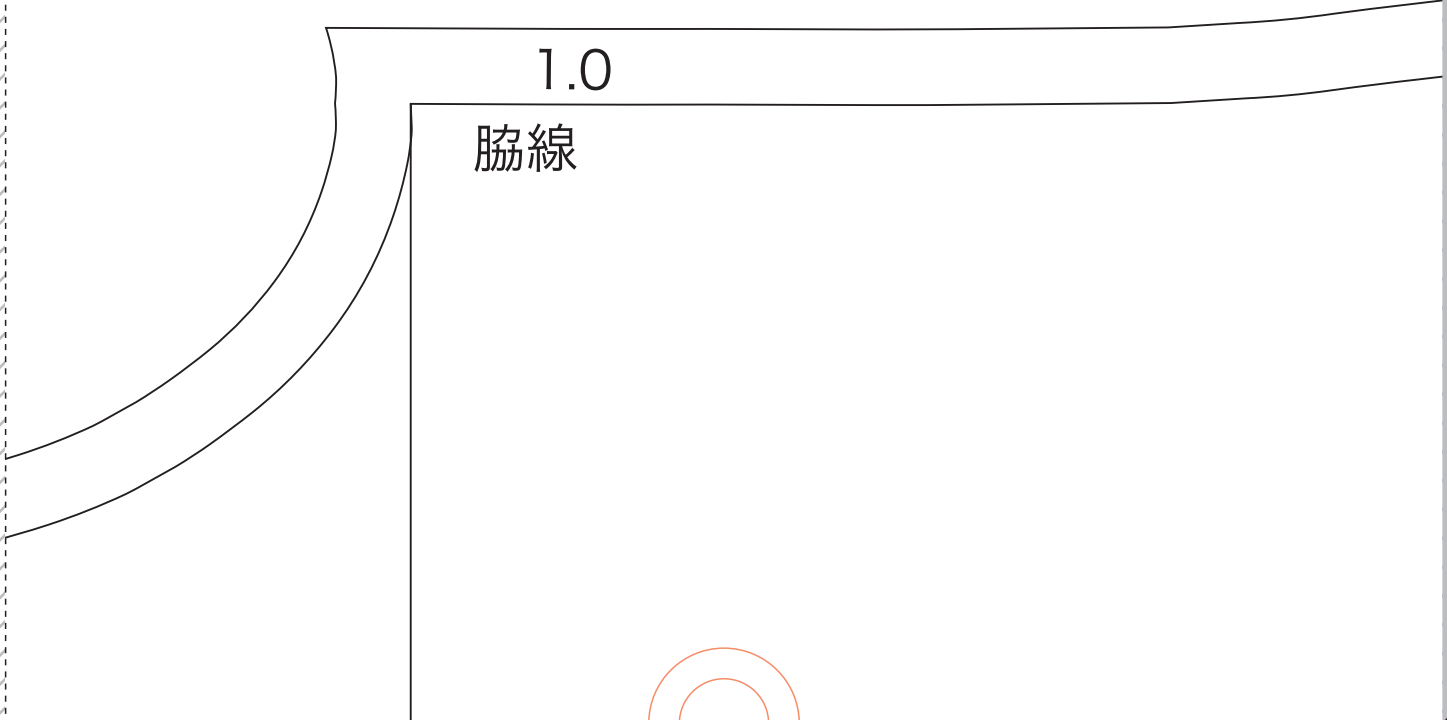
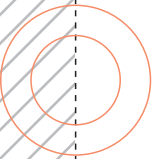

24

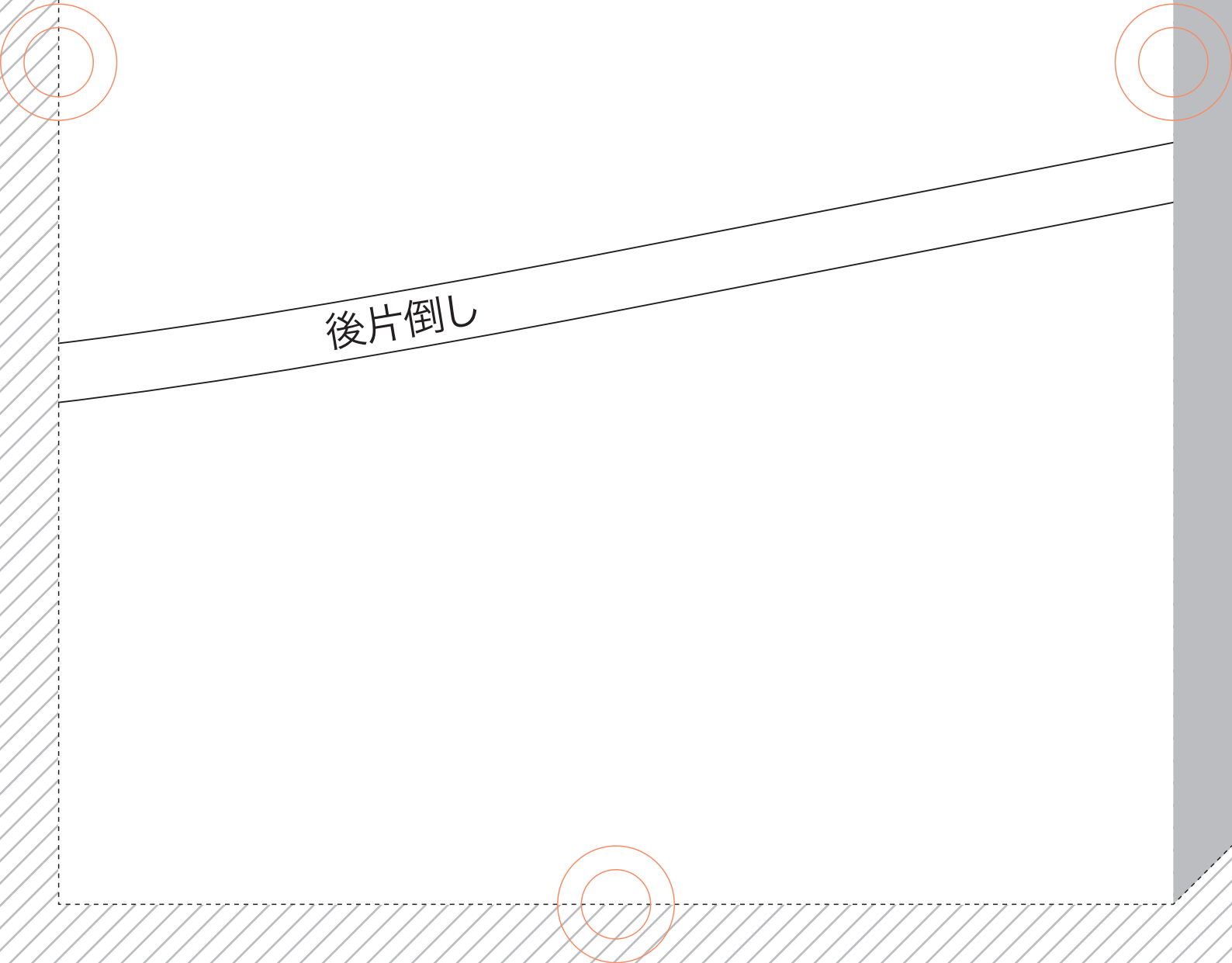

後片倒し

25

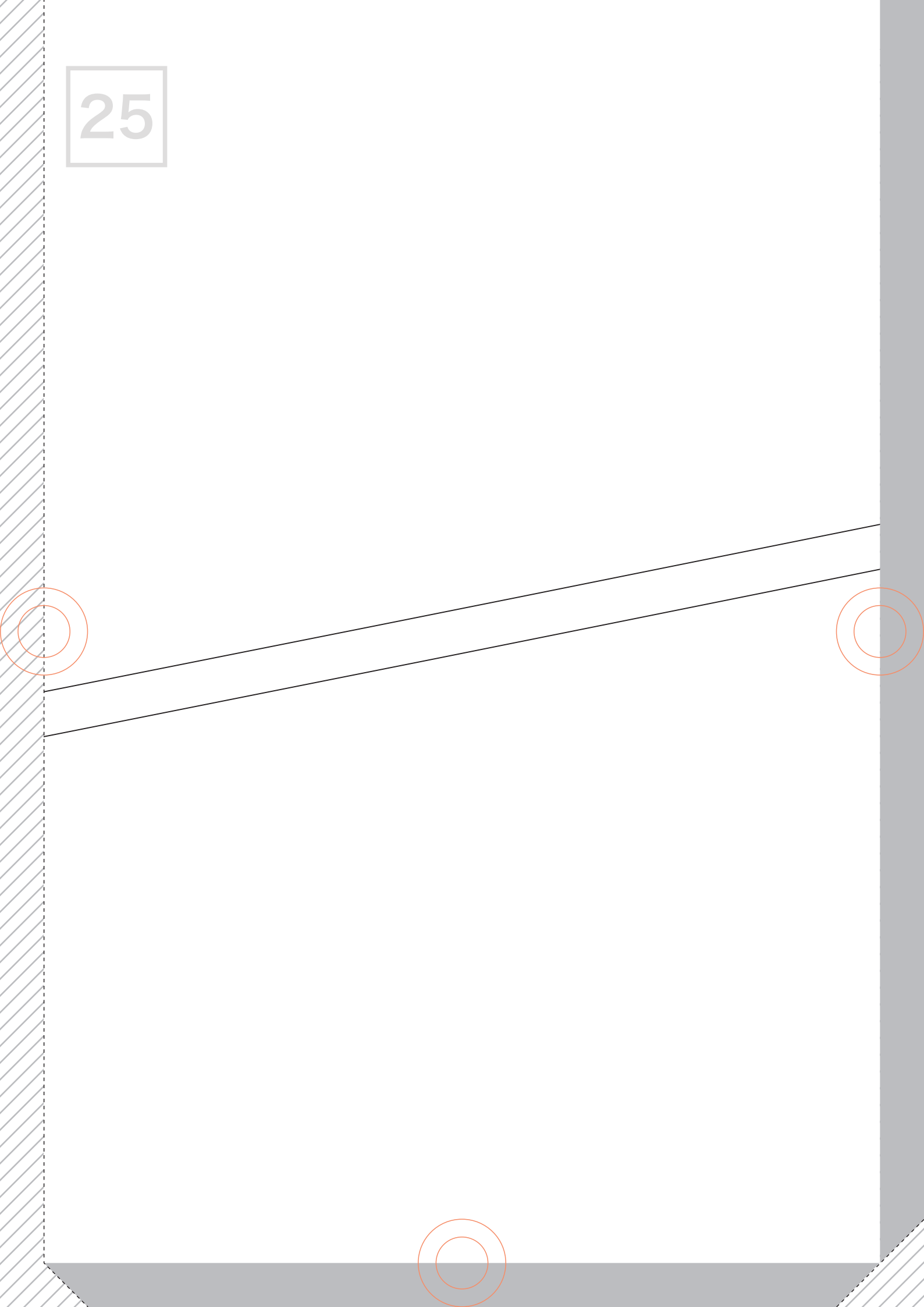
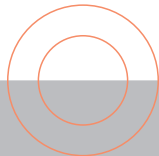
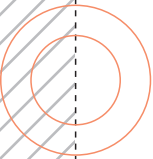

26

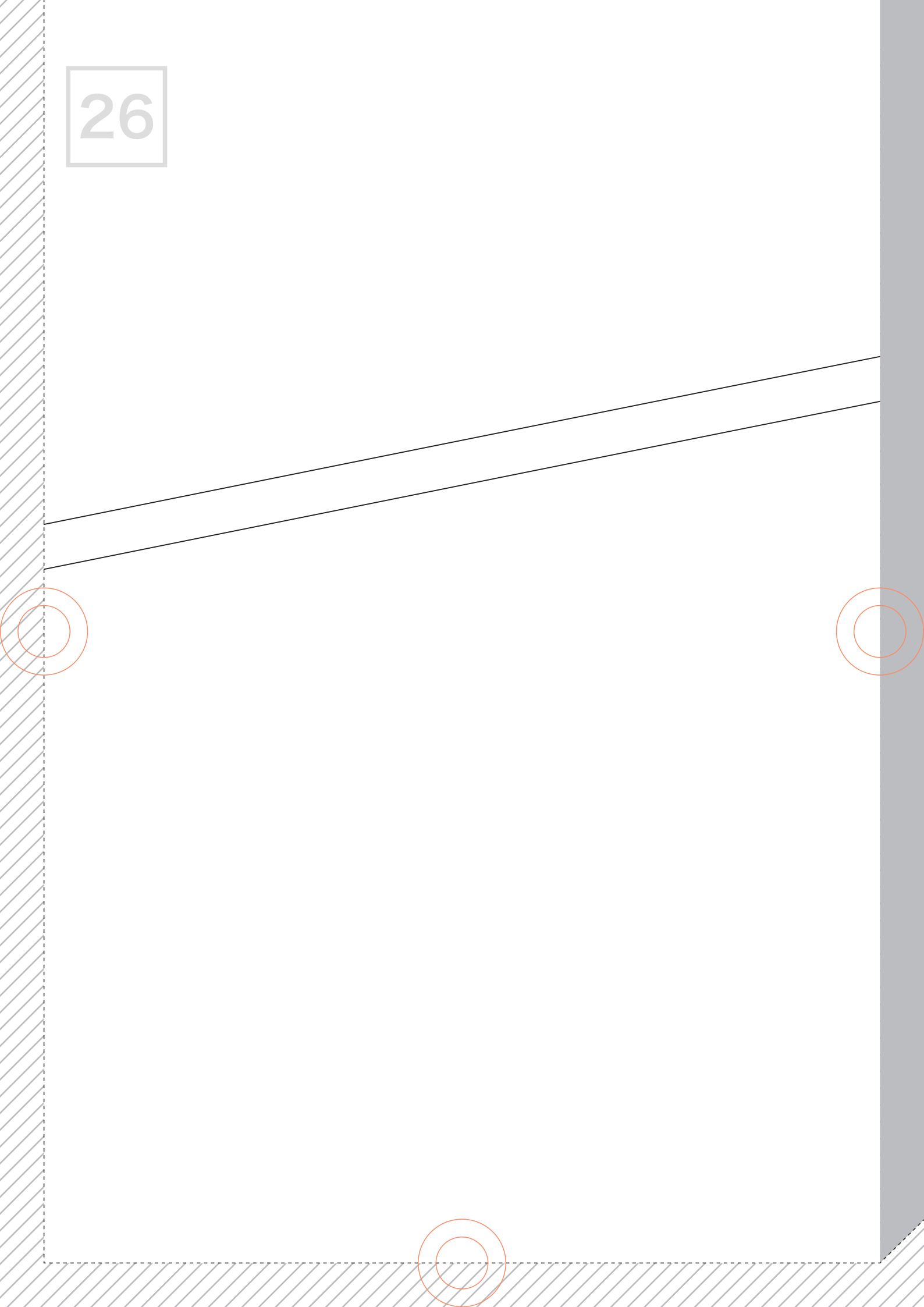

27

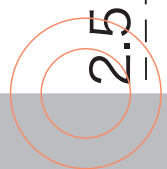
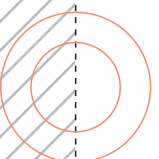

2.5cm三つ折りステッチ

3.5

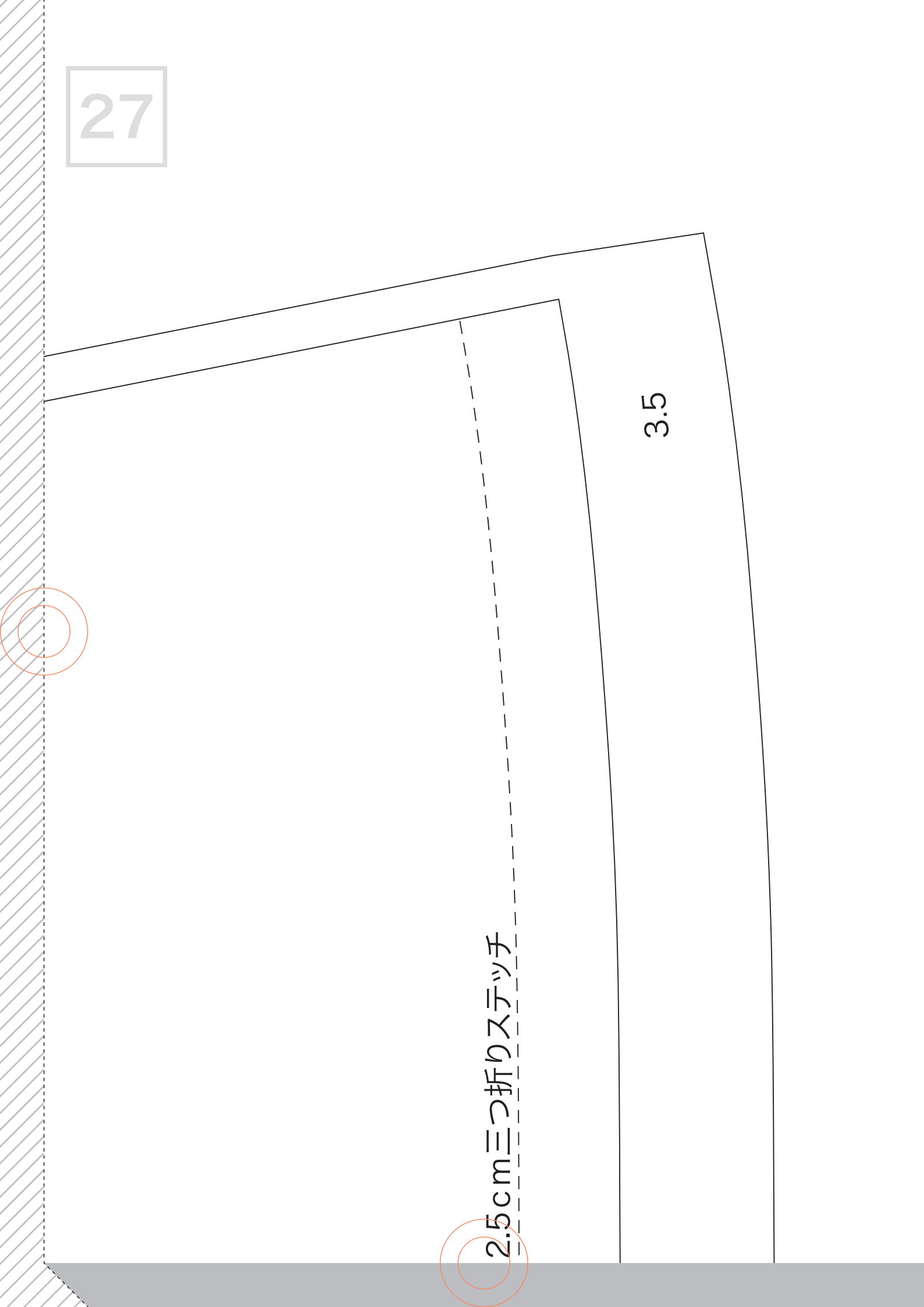

28

肩線

1.0

衿と接ぐ

後ろ中心わ

1.0

左肩

29

fabfab-9

後身頃

size: 9

表×1枚

π C

30

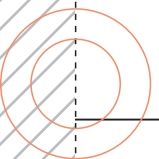
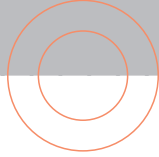

f a b f a b - 9

衿

折山線

size : 9

表 × 1 枚

○ 右肩



31

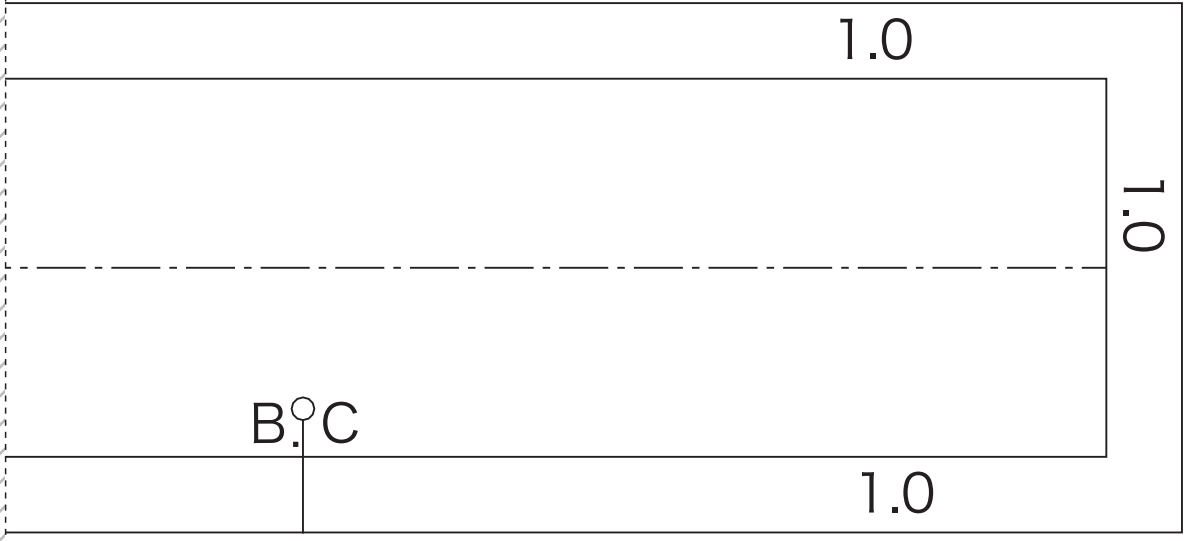
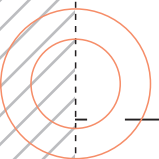
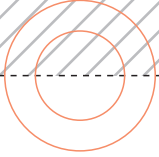

32

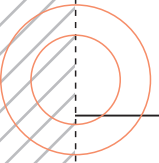
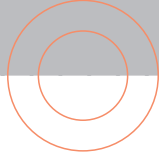

33

裾線

