



## introduction はじめに

パターンは A4 サイズ 54 枚に分割されています。  
印刷後、右図のようにつなぎ合わせてください。

### ! 印刷時の注意

印刷設定では、「ページの拡大や縮小」を選択せず  
必ず、「実際のサイズ」(原寸) で印刷してください。

## how to make パターンのつくりかた

**STEP1** 斜線部分  は切り取り、灰色部分  は残してのりしろにします。  
(斜線と灰色を間違えないように注意)

**STEP2** 各用紙の番号を確認し、 の位置を合わせて、のりづけします。  
(水のりは用紙が波打ちます。スティック糊などをお使いください)

**STEP3** それぞれのパーツをハサミで切り出します。

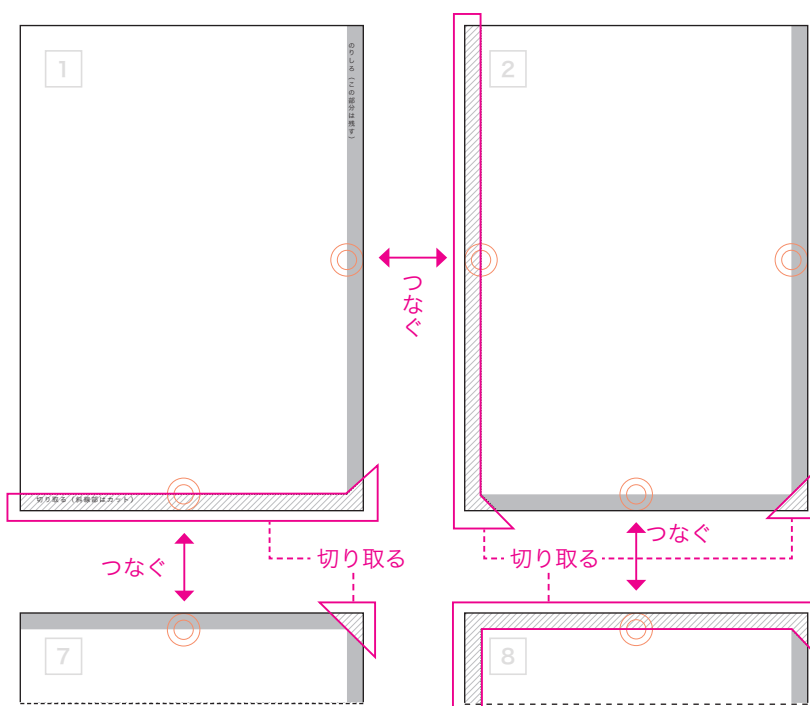
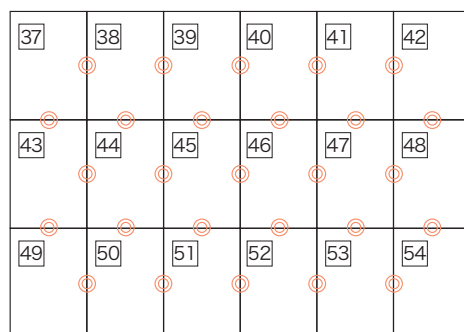
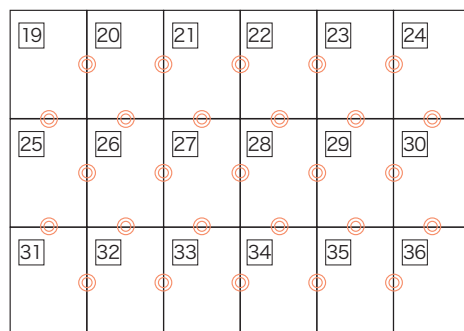
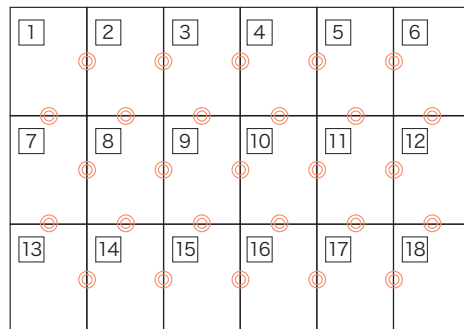

のりしろ (この部分は残す)

1

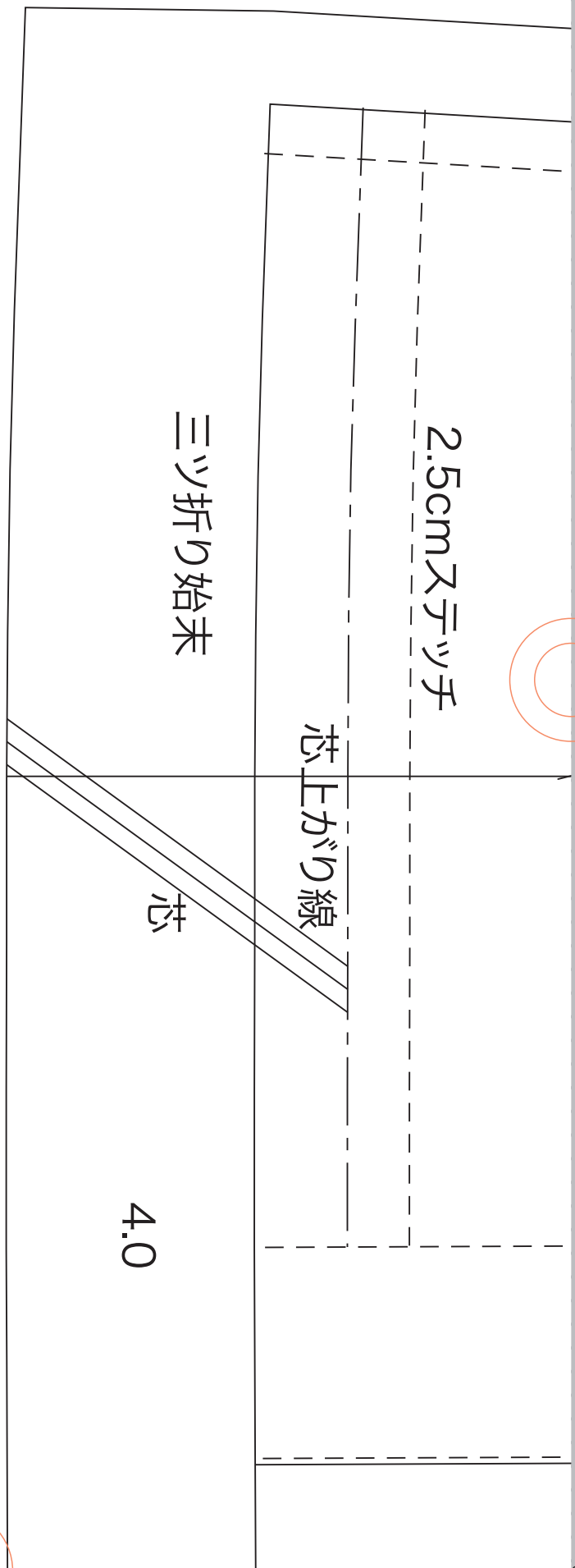

切り取る (斜線部はカット)

2

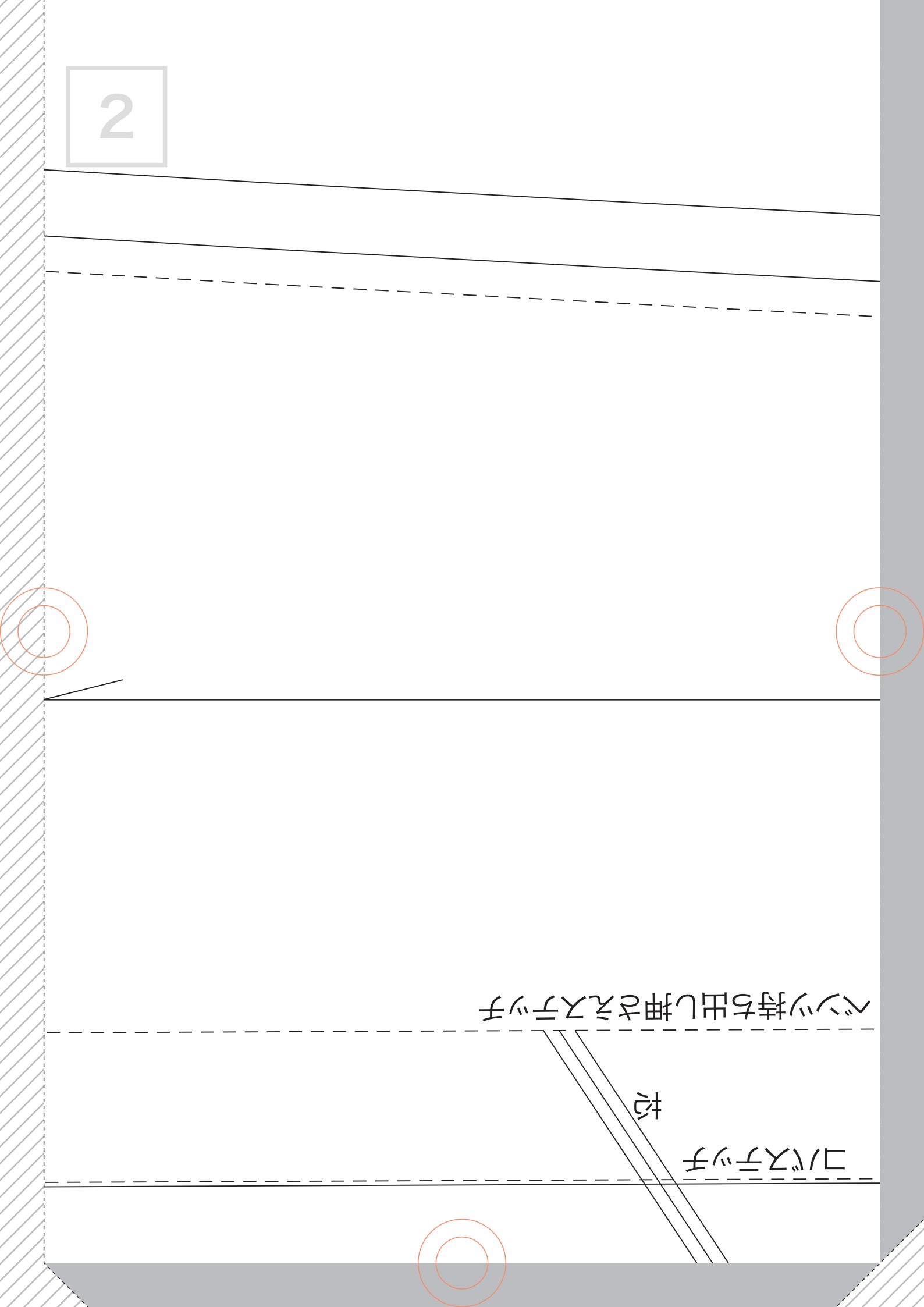

ハット持ち出し押さえステッチ

栓

コバステッチ

3

折り伏せ始末

0.8cmアツチ

折る

1.0

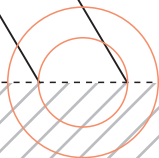
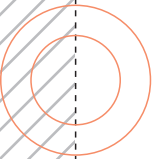

4

1.5

裏地上がり線

折り伏せ始末

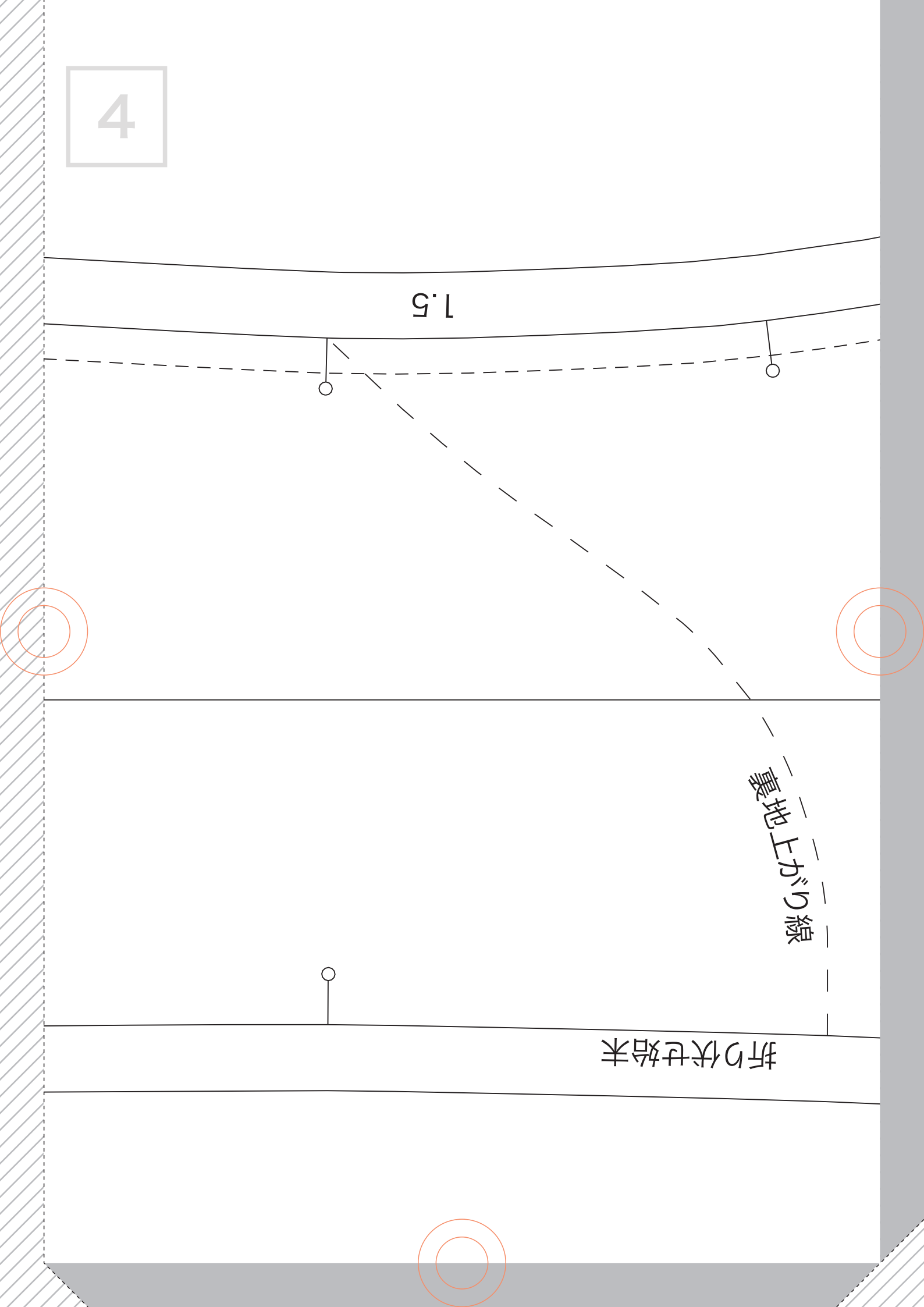

5

1.0

fabfab-13  
左後身頃  
size : 9  
表×1枚

B・C

1.5

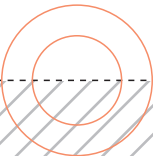
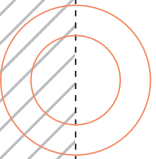

6

折り伏せ始末

1.5

0.8cmスリッチ

0.5cmスリッチ

1.0

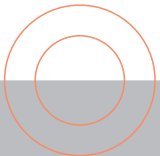
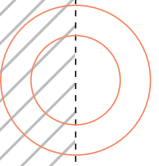

7

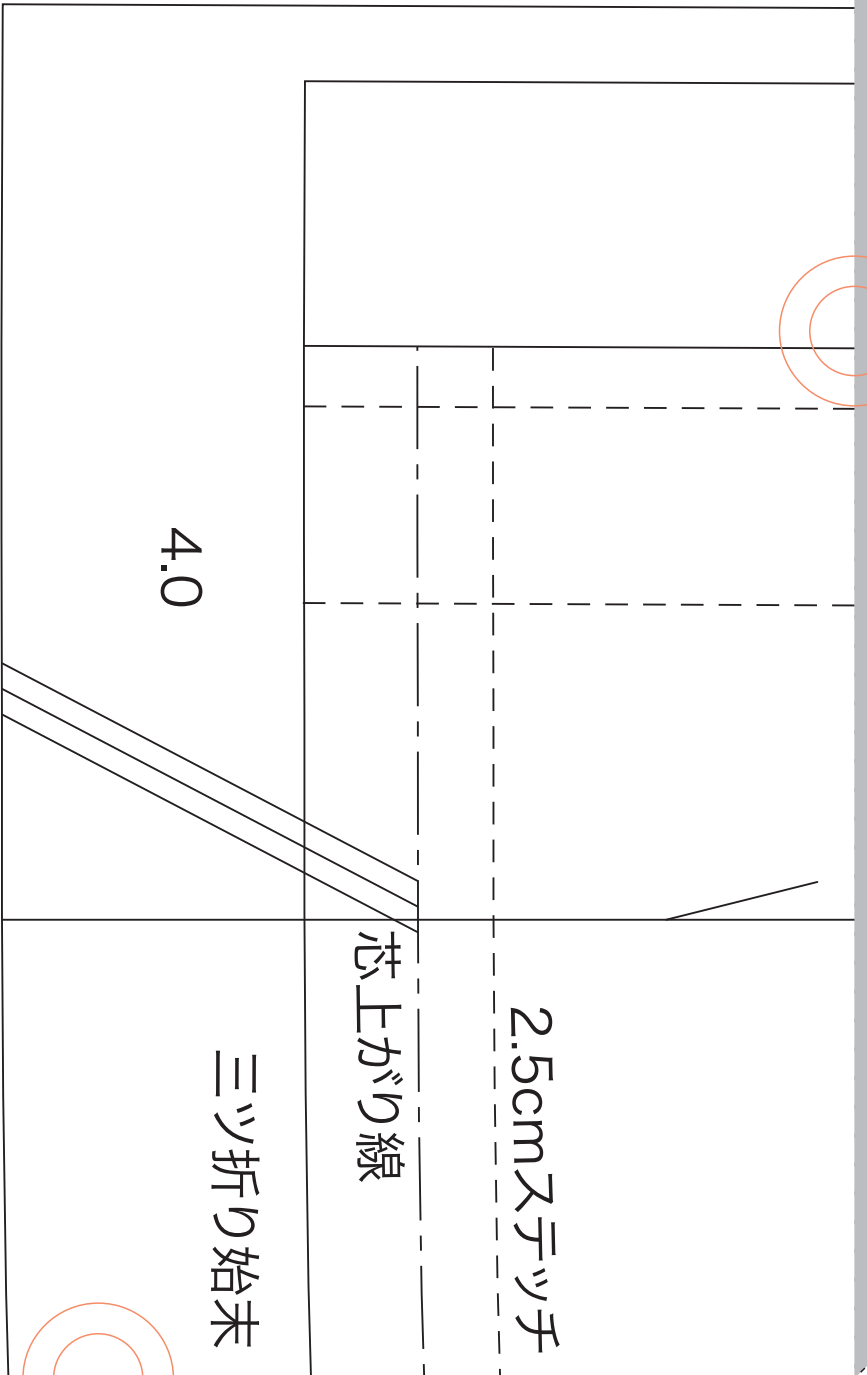



8

1.0

枠

ベッツ見返し押さえスッチ

9  
1.0

1.0

7  
ツ  
ツ  
ツ

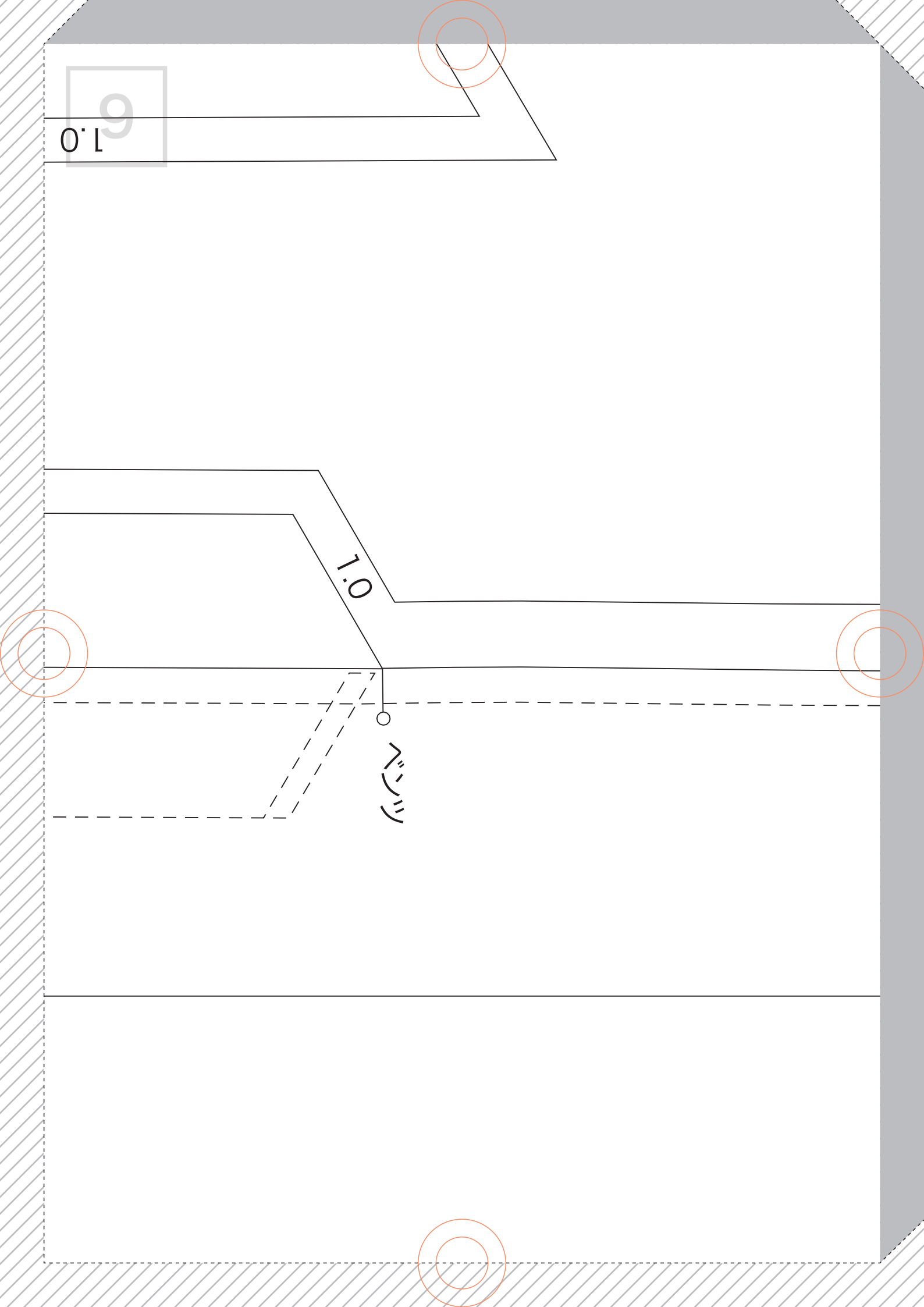

10

折り伏せ始末

裏地上カブリ線

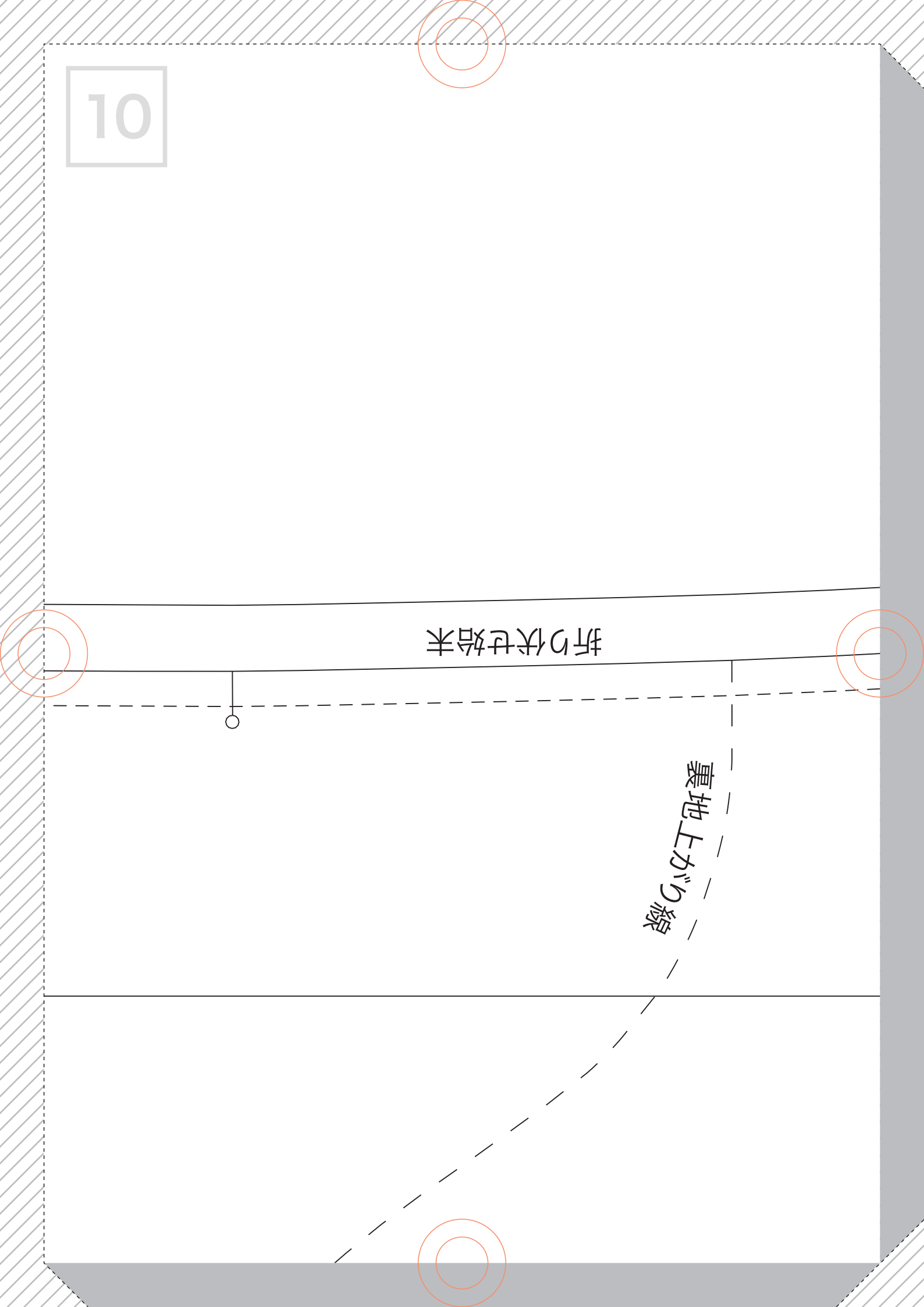

11

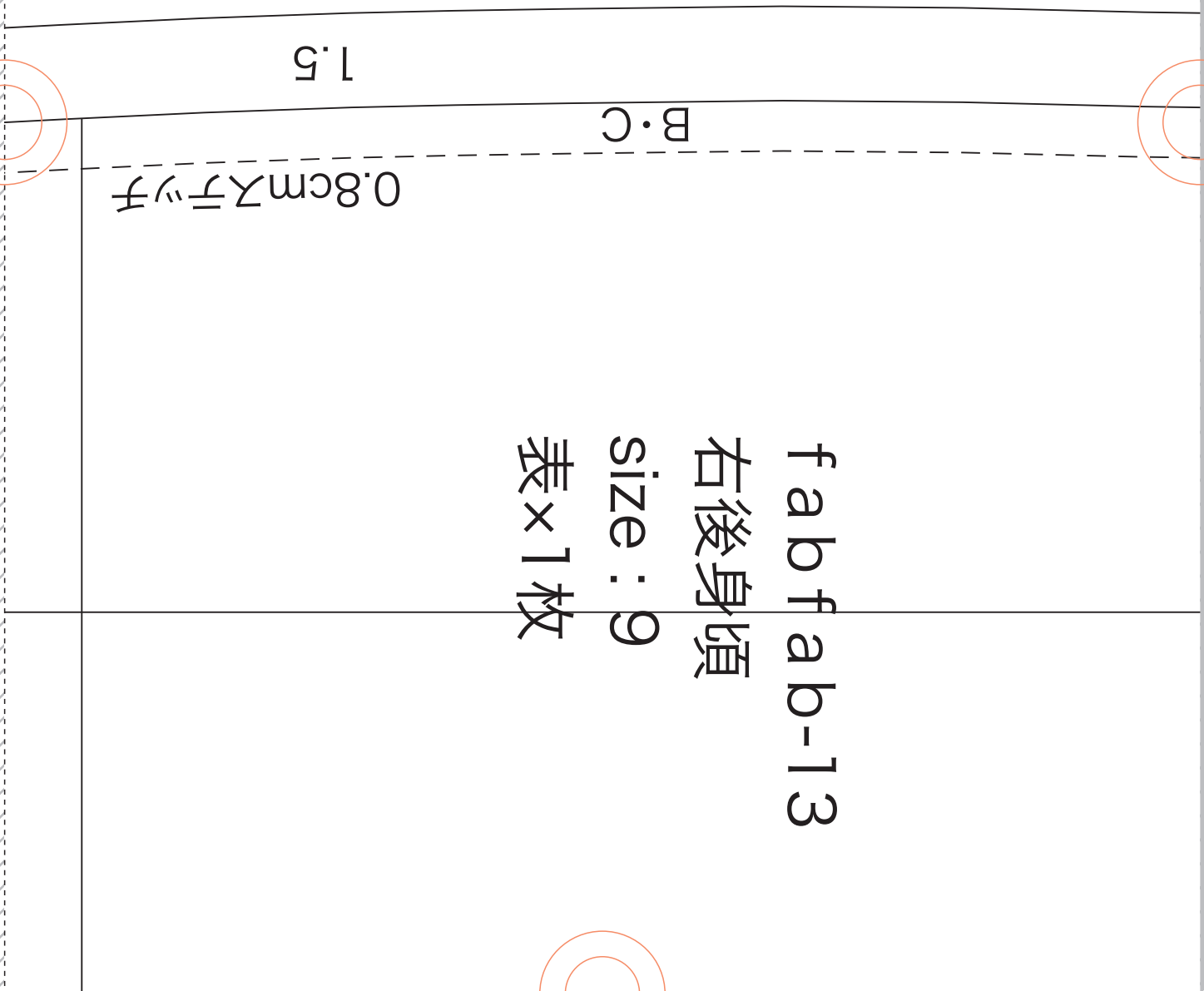

fabfab-13

右後身頃

size : 9

表×1枚

12

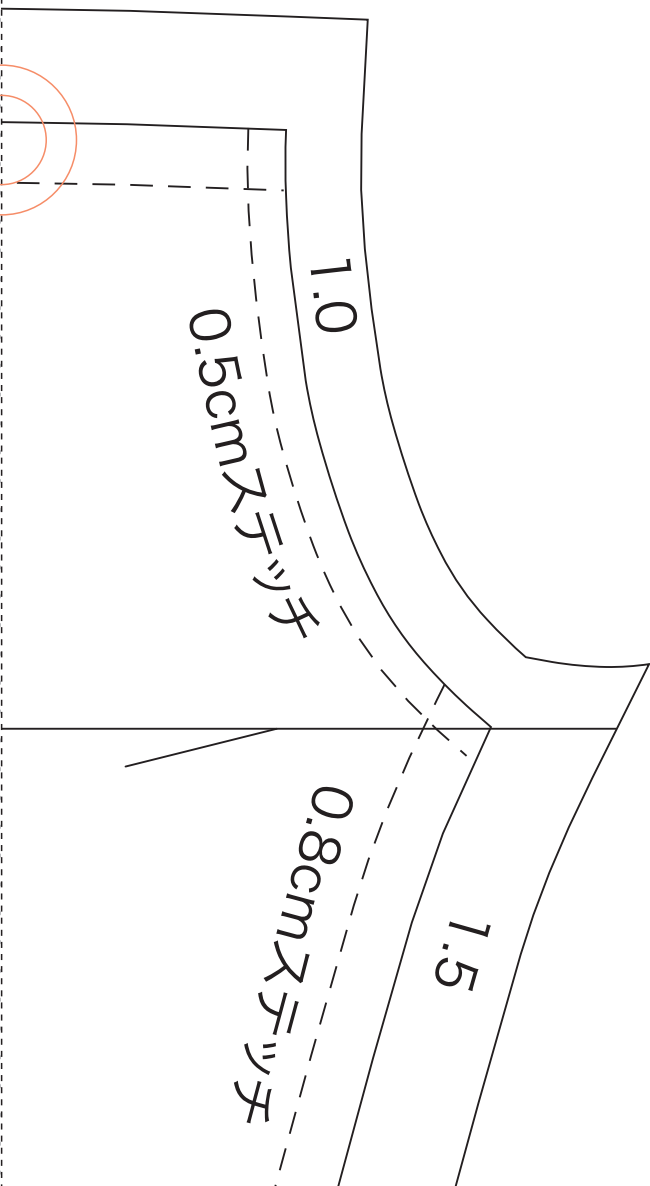

13

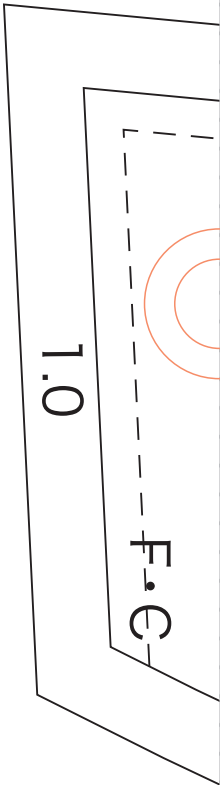
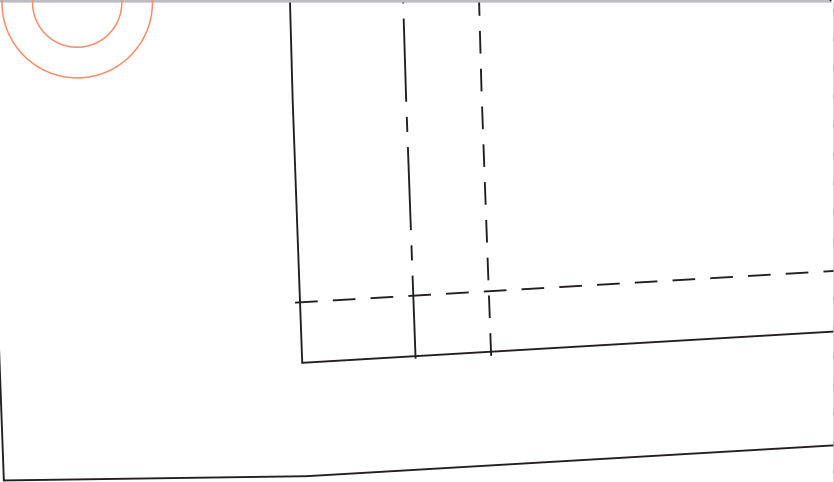
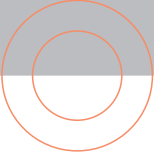

14

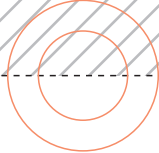

0.5cmステッチ

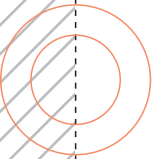

N<sup>o</sup>. P

15

0.8cmヌツチ

折り伏せ始末

1.0

fabfab-13

衿

size : 9

表×2枚

芯×2枚

B · C

N · P

1.0



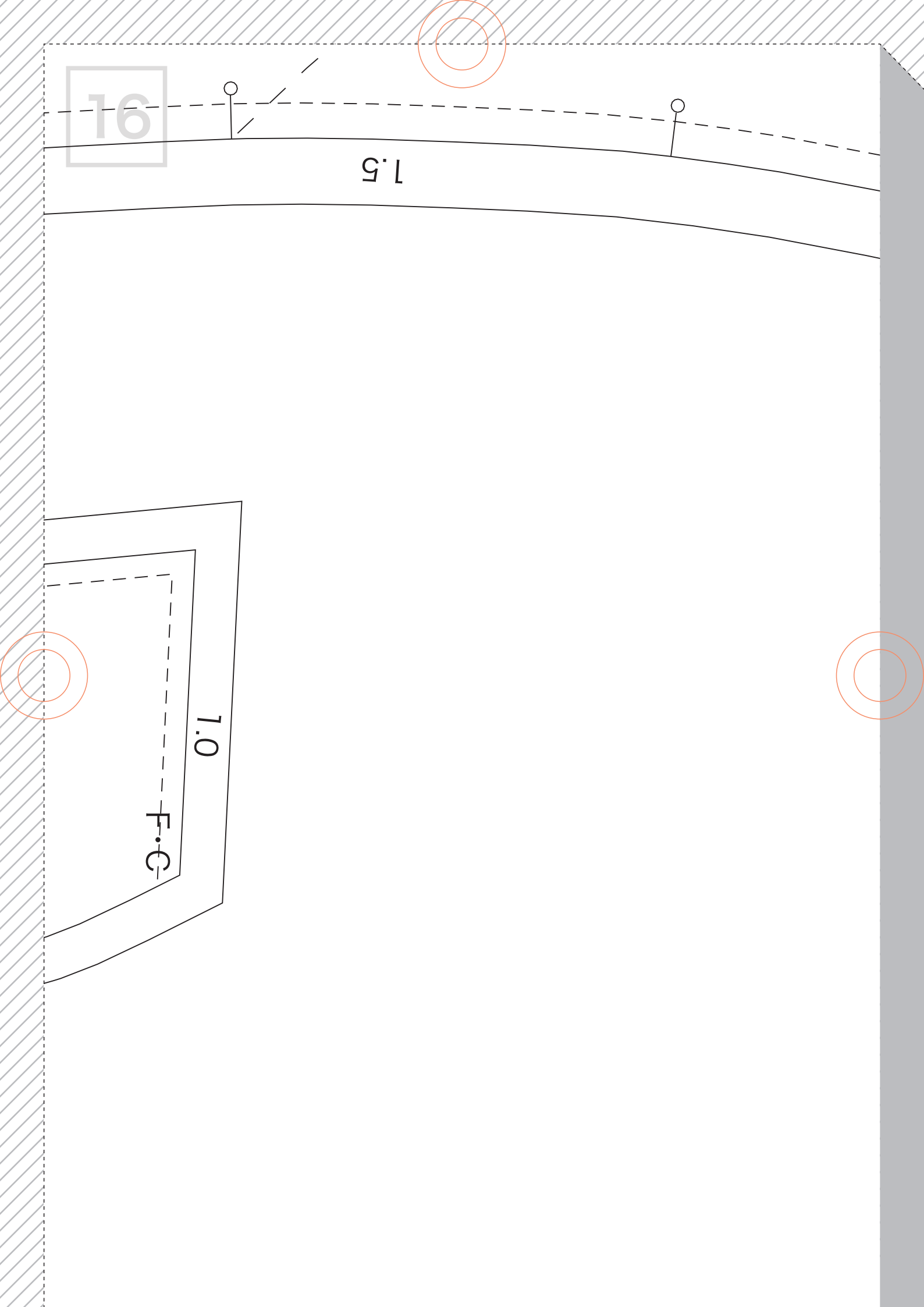

17

0.1

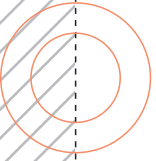
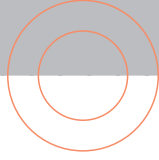

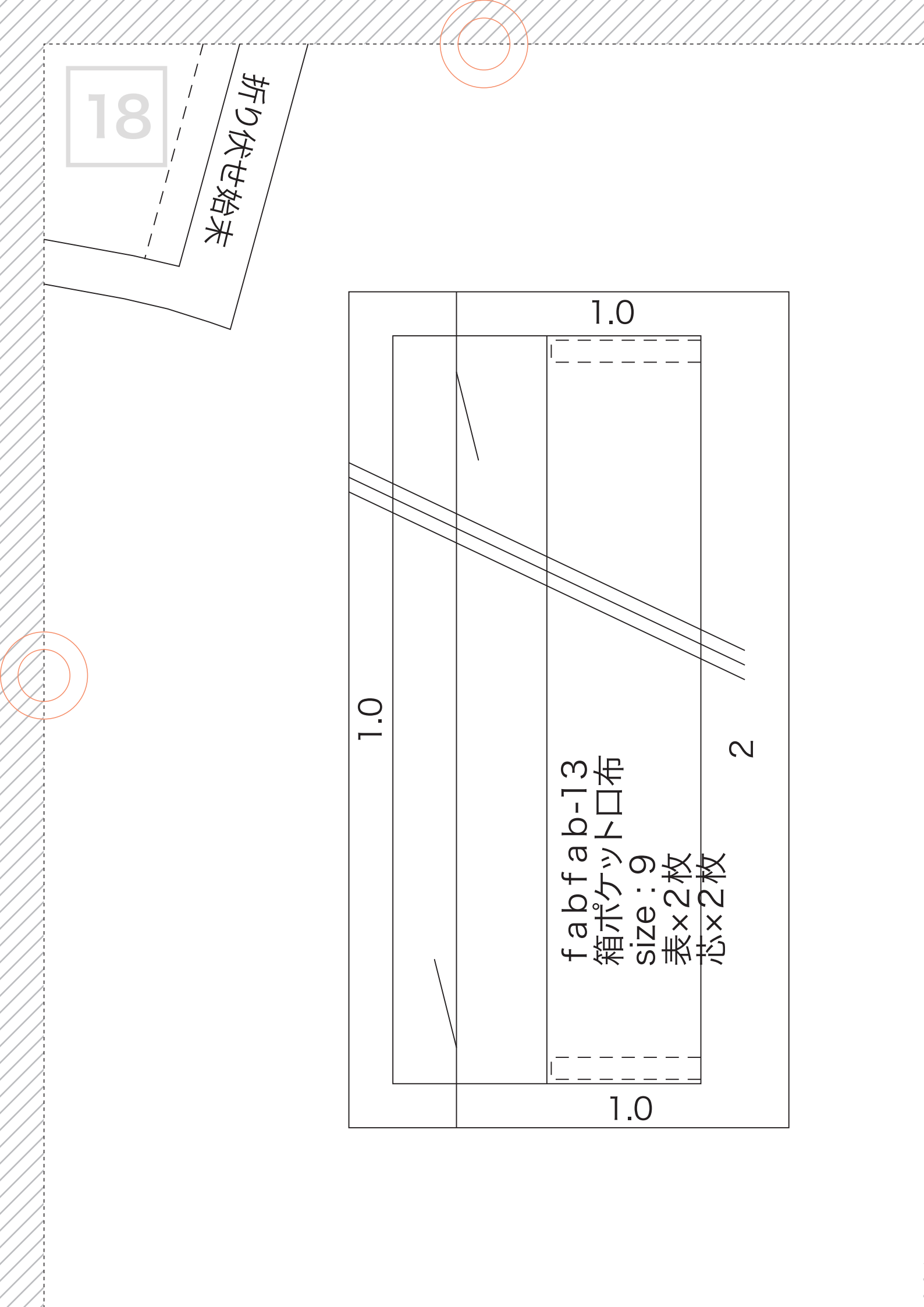

1.8

折り伏せ始末

1.0

1.0

fabfab-13  
箱ポケット口布  
size: 9  
表×2枚  
芯×2枚

2

1.0

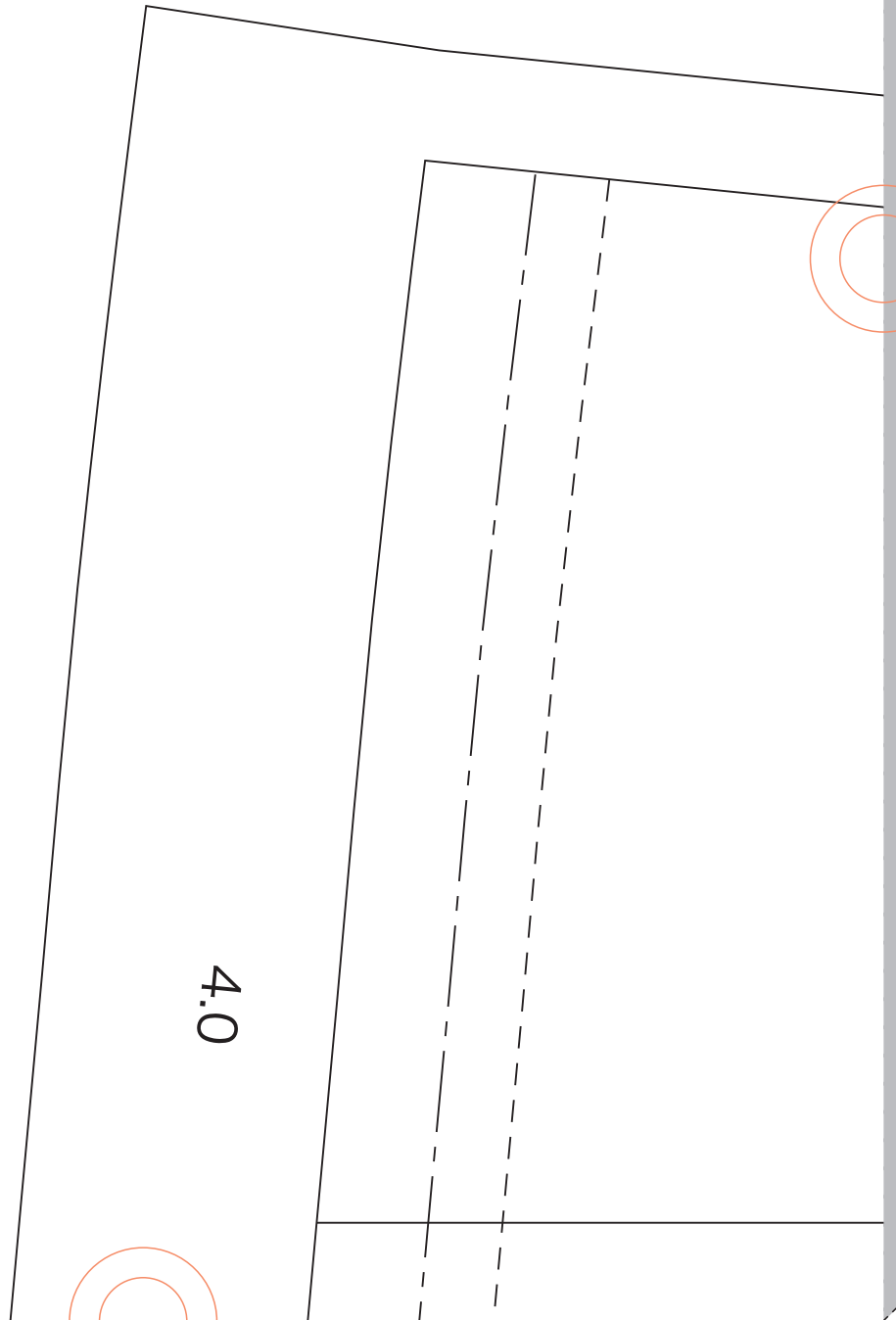

切り取る（斜線部はカット）

20

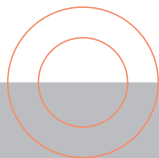
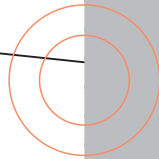
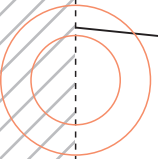

21

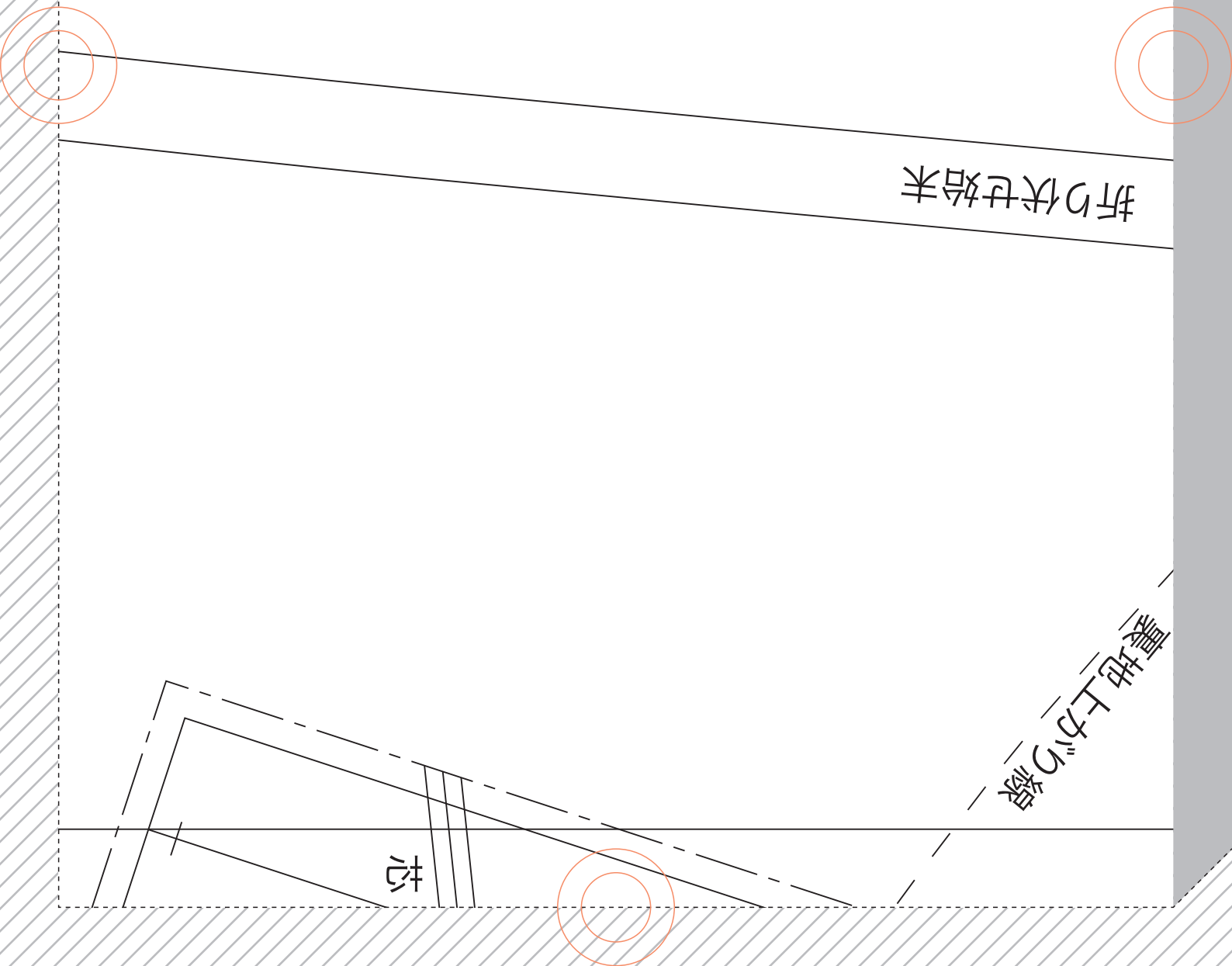

22

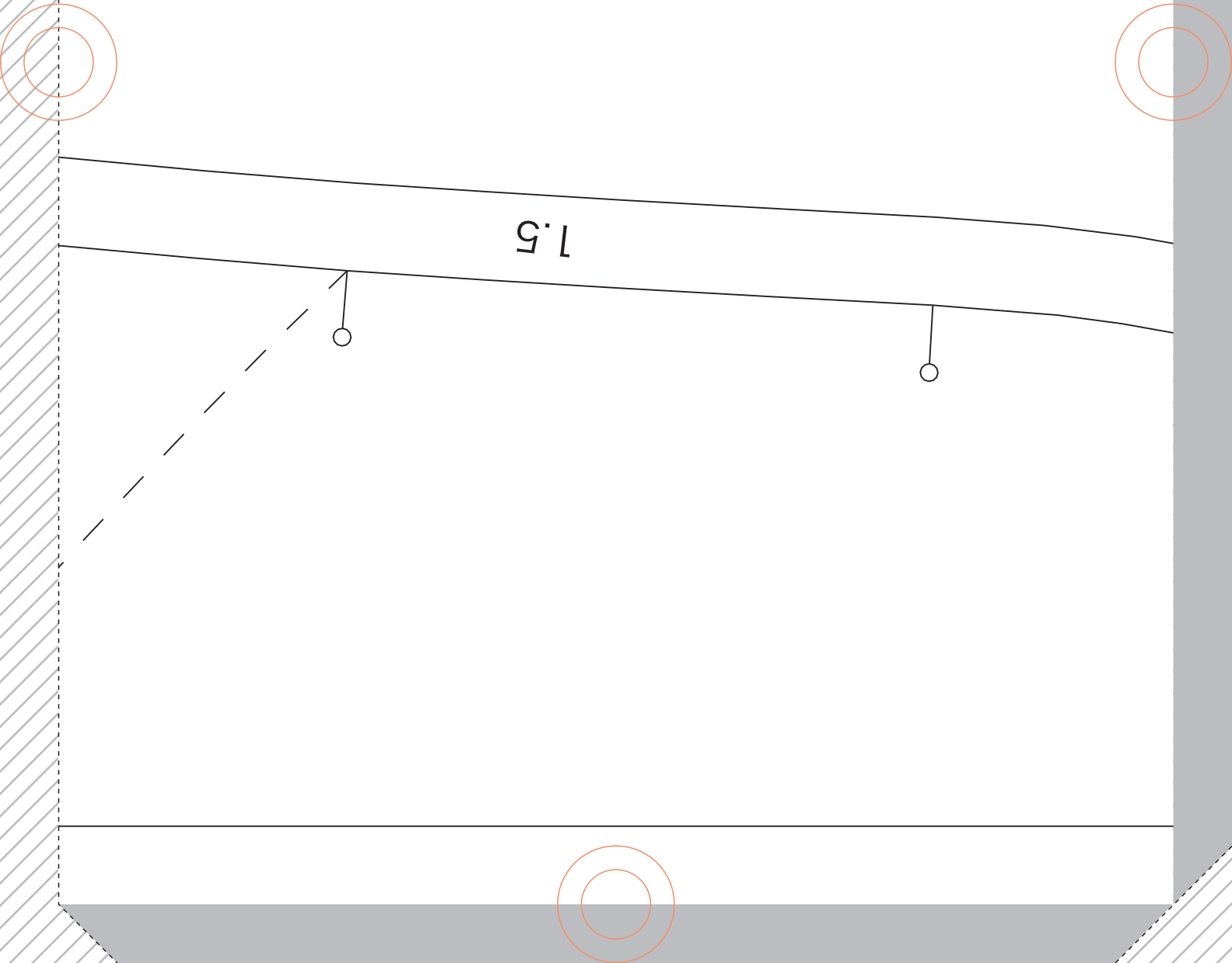

23

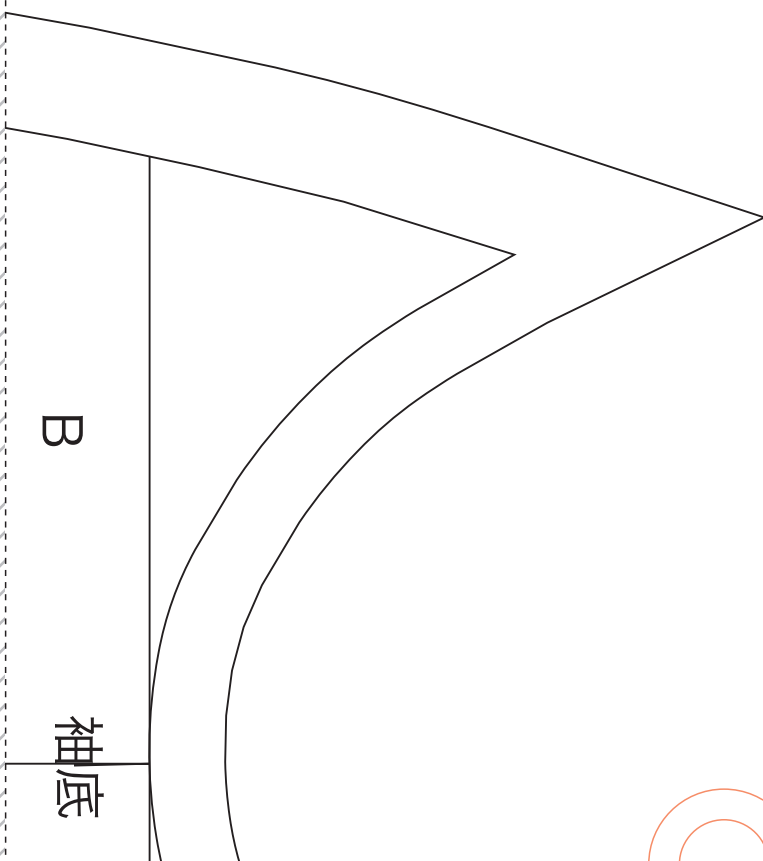



24

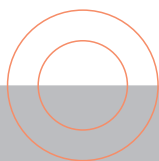
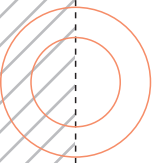

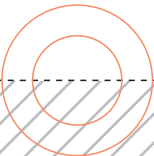
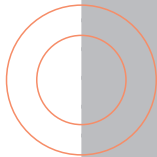
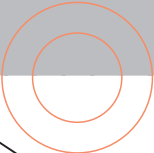
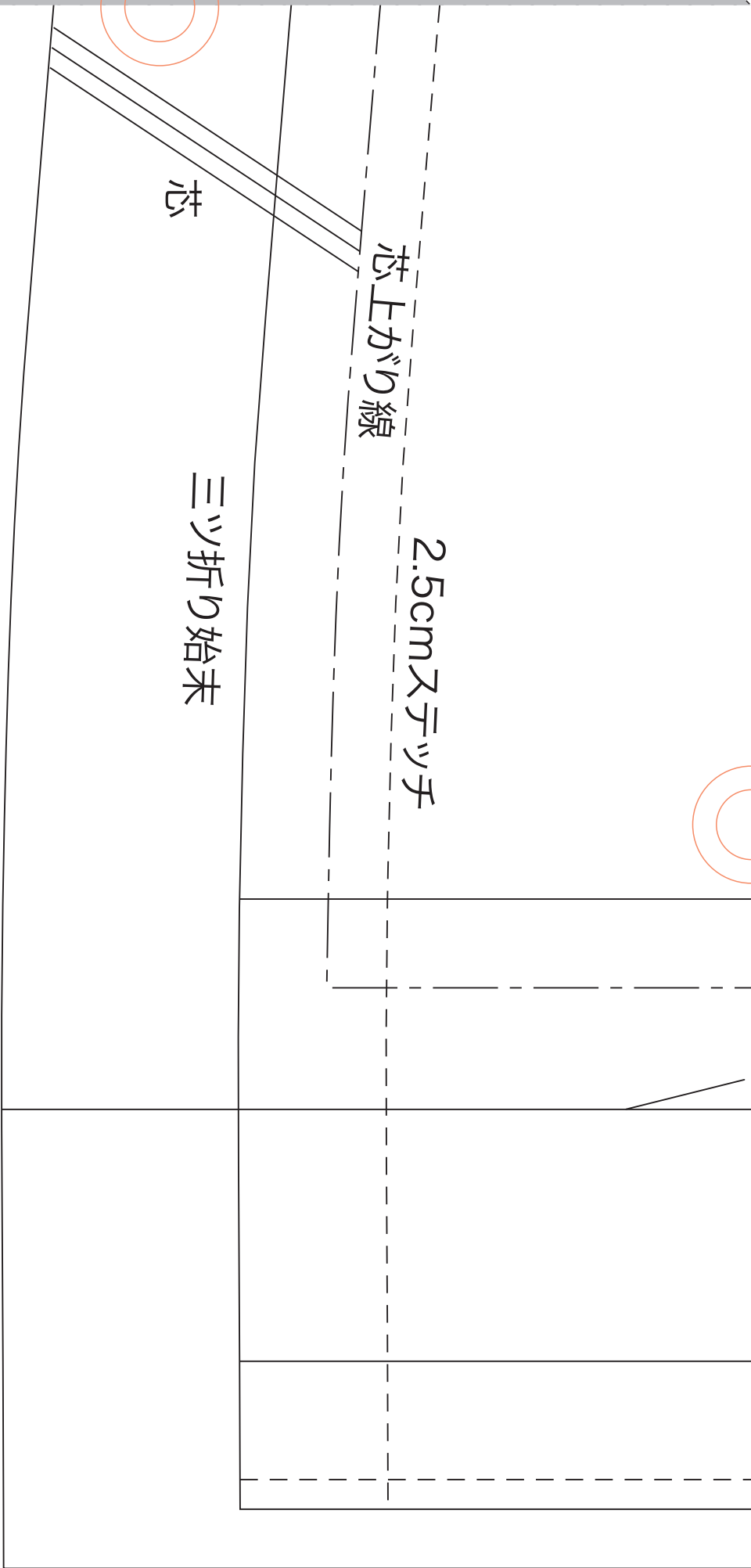

26

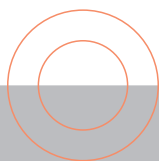
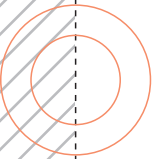
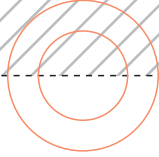

27

切り込み位置

箱ポケット

口布のまわり芯貼る

見返し線

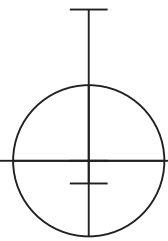
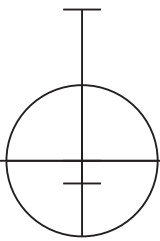

28

fabfab-13

前身頃

size : 9

表×2枚

芯上がり線

芯

1.0

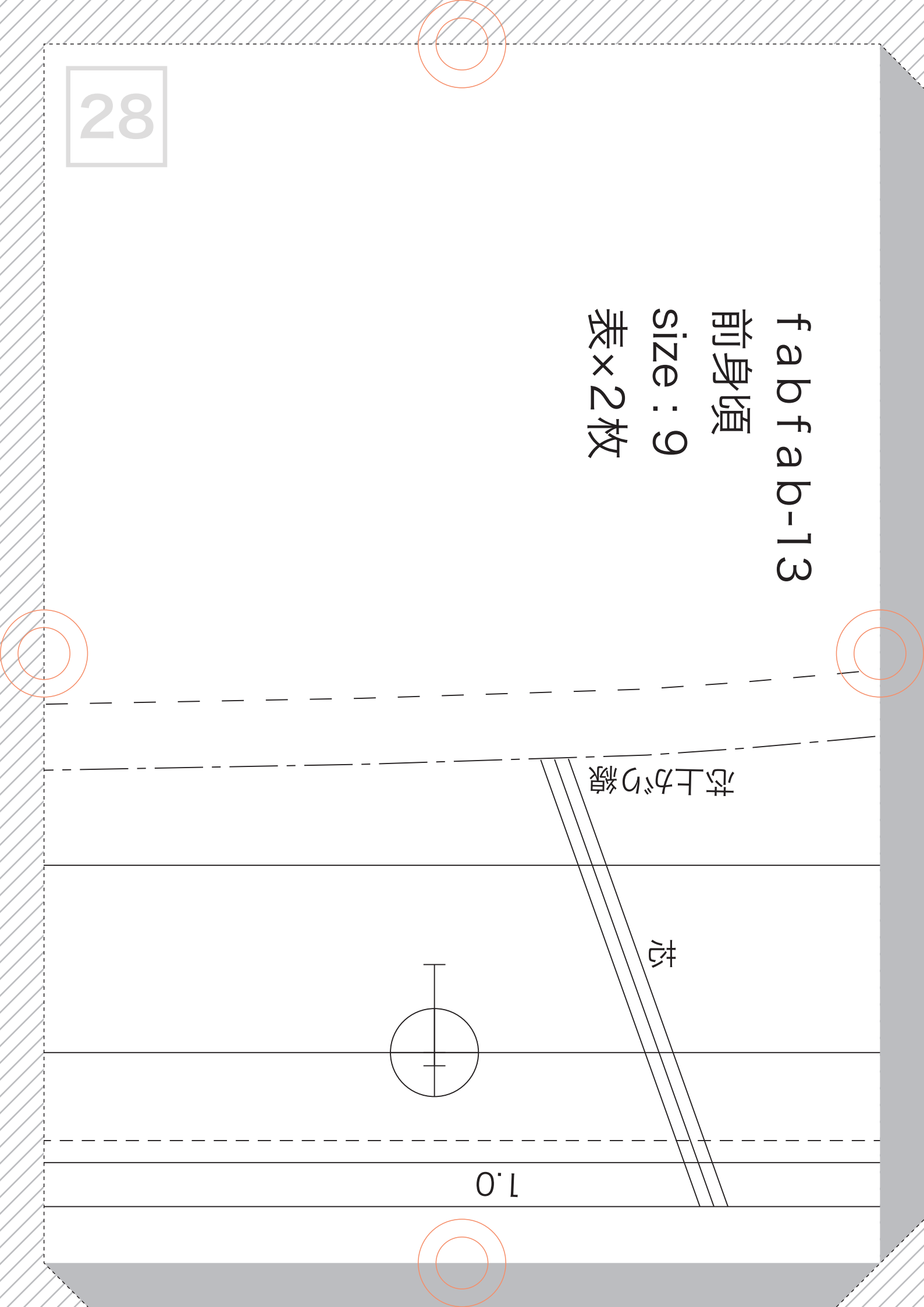
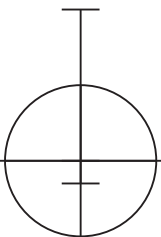

29

F

1.0

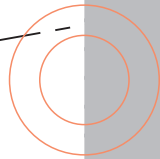
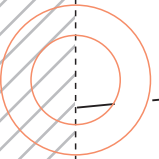

枠づく

1.0

F・C

20mm釘

0.5cmステッチ

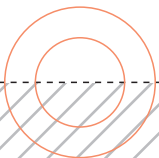

30

1.5

0.5cm  
フツフツ

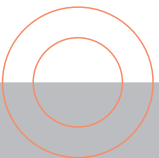
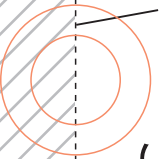
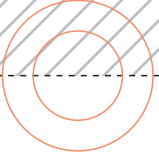

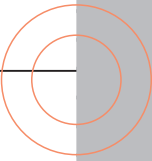
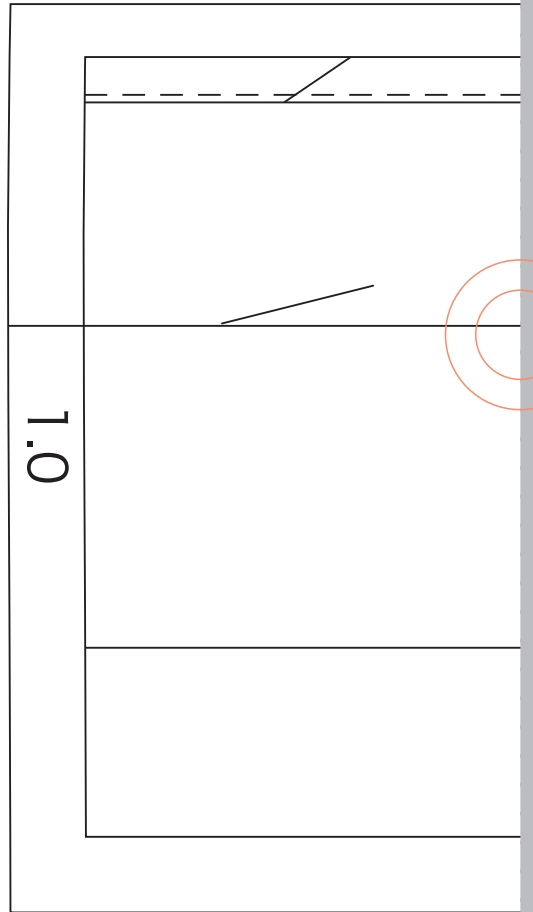
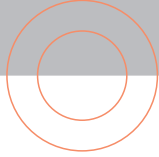



32

6mmパイプスタート始末

33

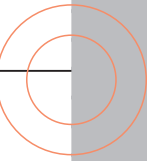
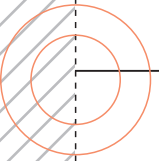
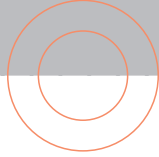

34

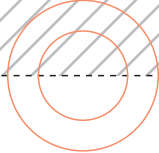

0.7

1.0



35

fabfab-13  
前見返し

size : 9  
表×2枚  
芯×2枚

F・C

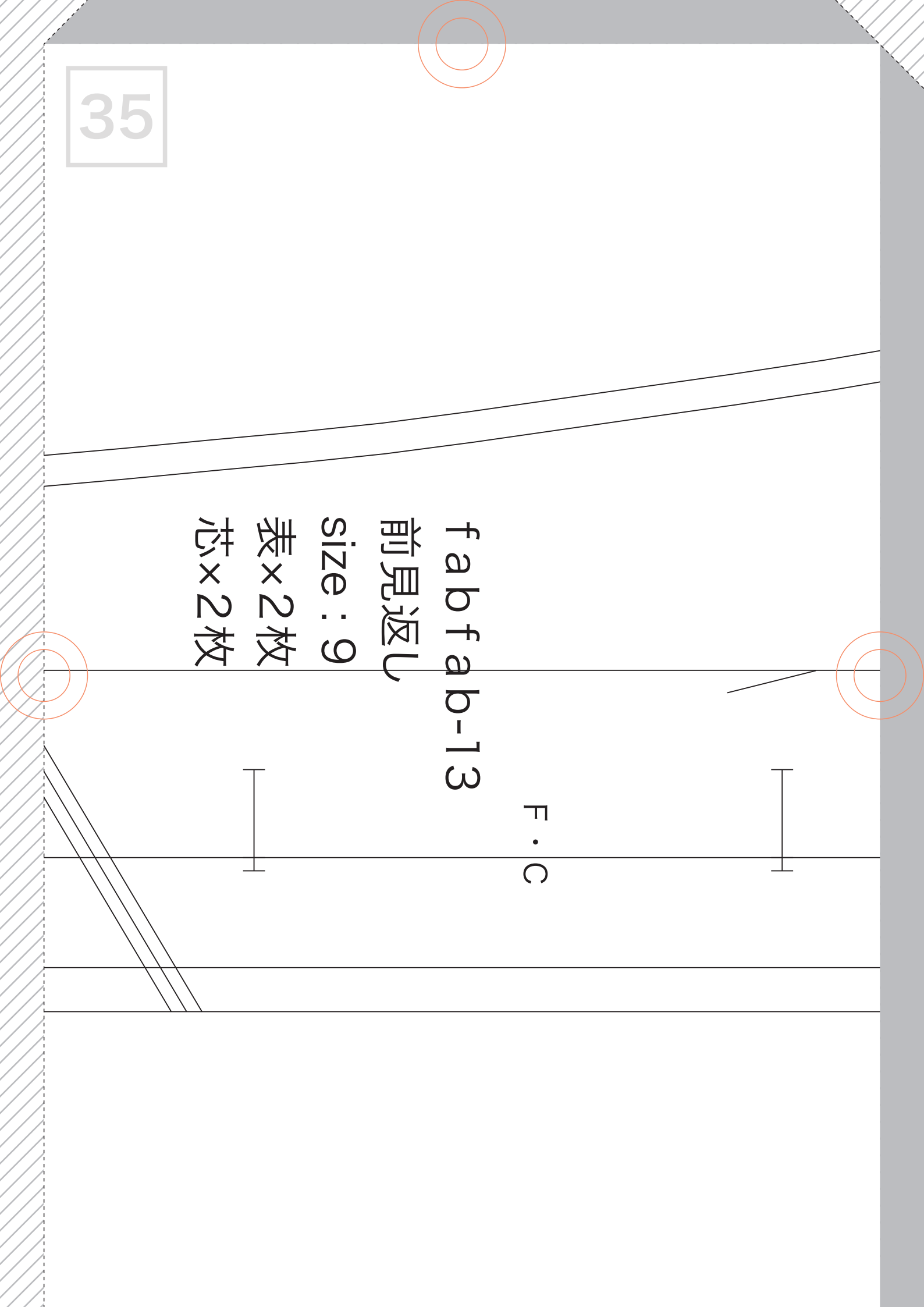

36

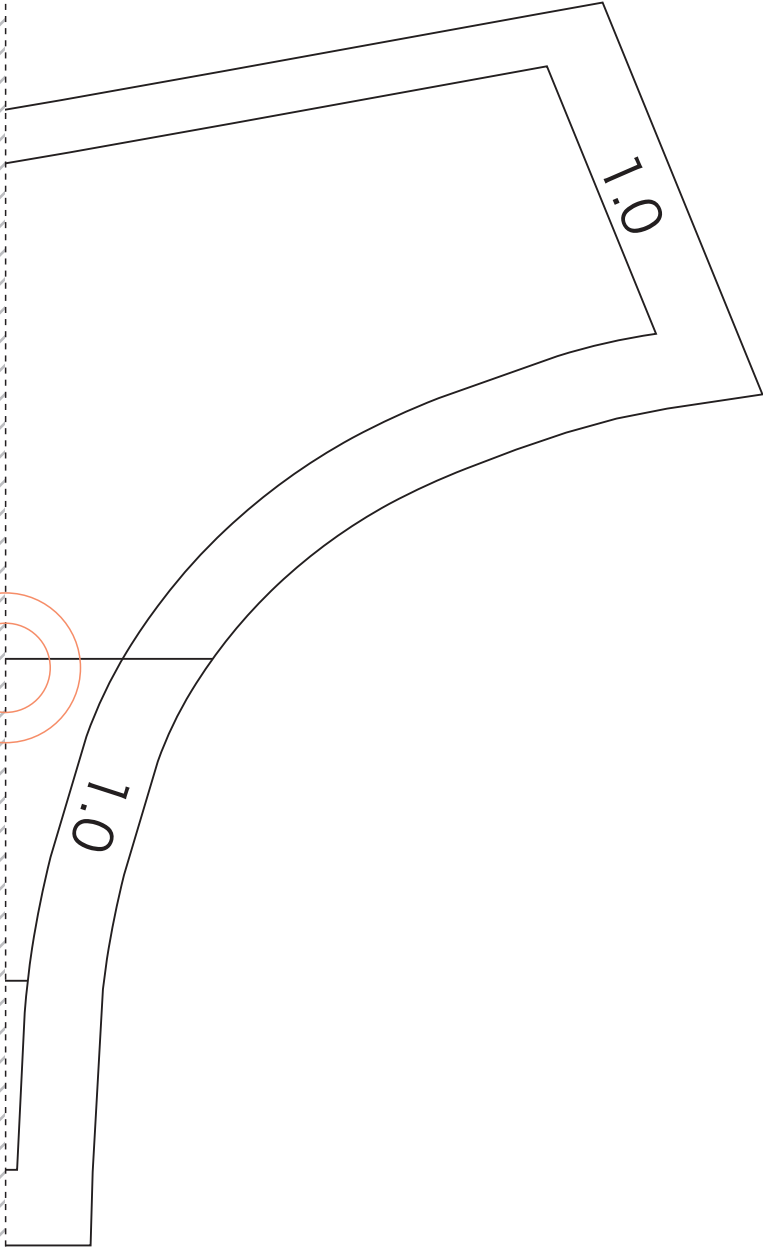
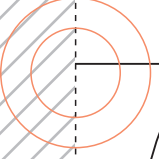
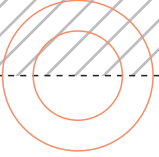

37

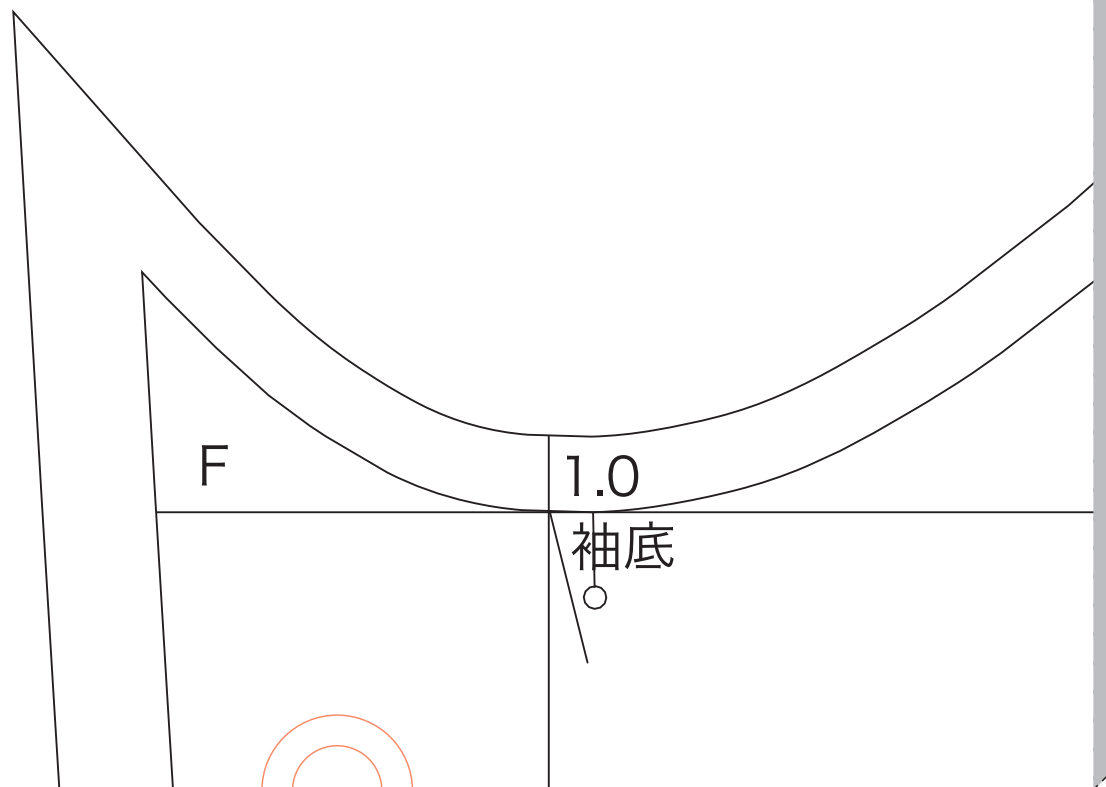

切り取る (斜線部はカット)

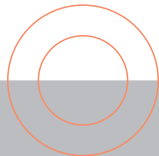
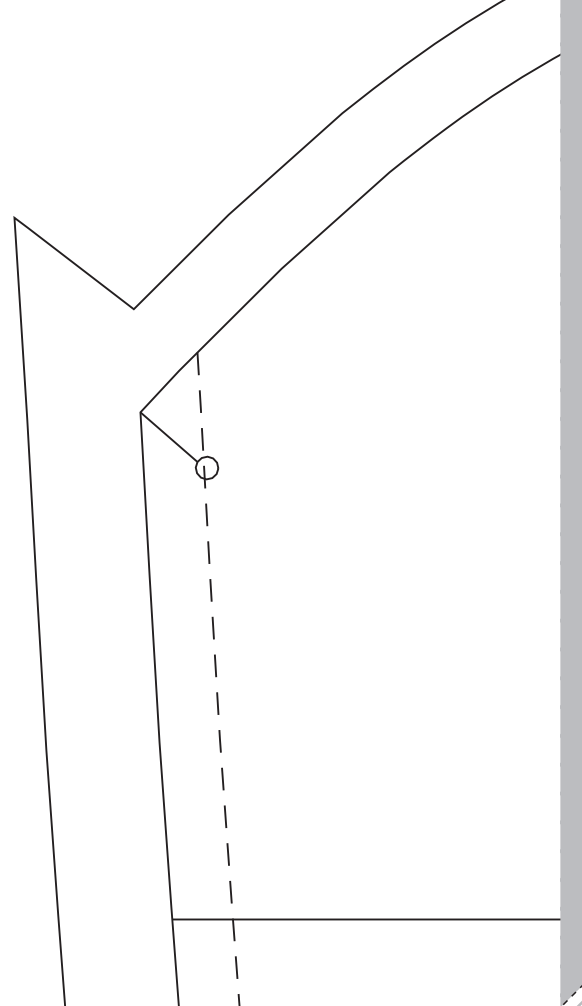
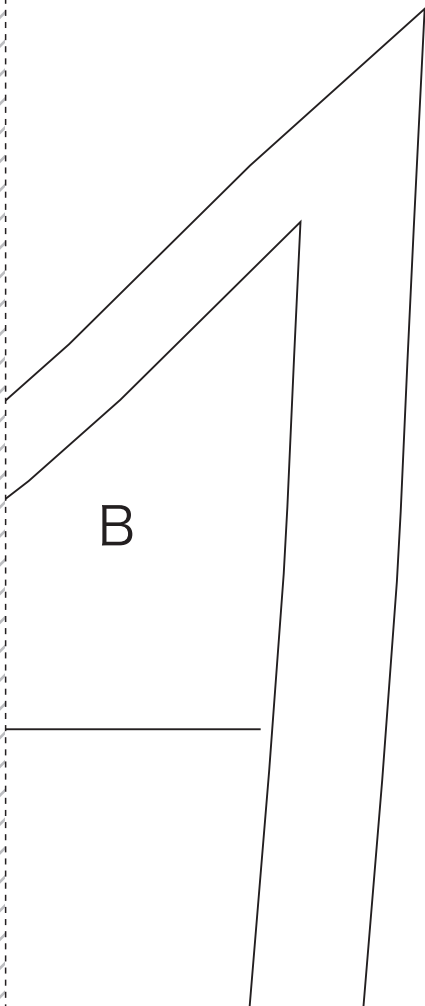
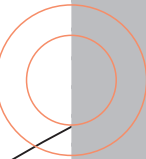
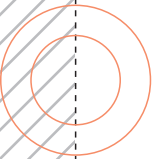

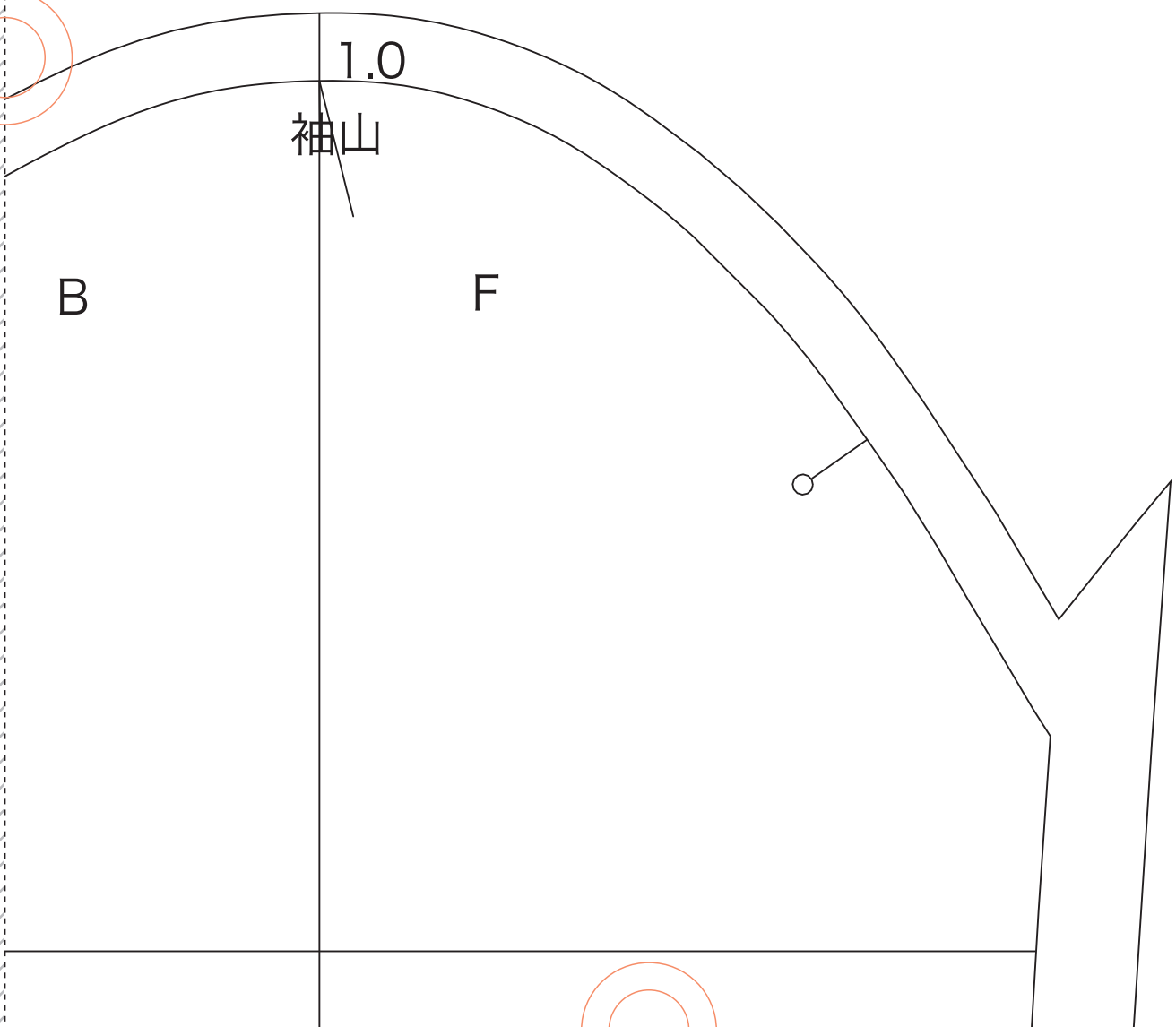



40



f a b f a b - 1 3

身頃裏

size : 9

裏 × 2 枚

41

1.0

1.0

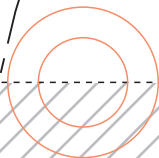
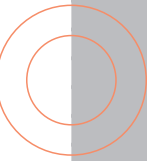
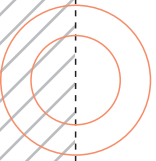

42

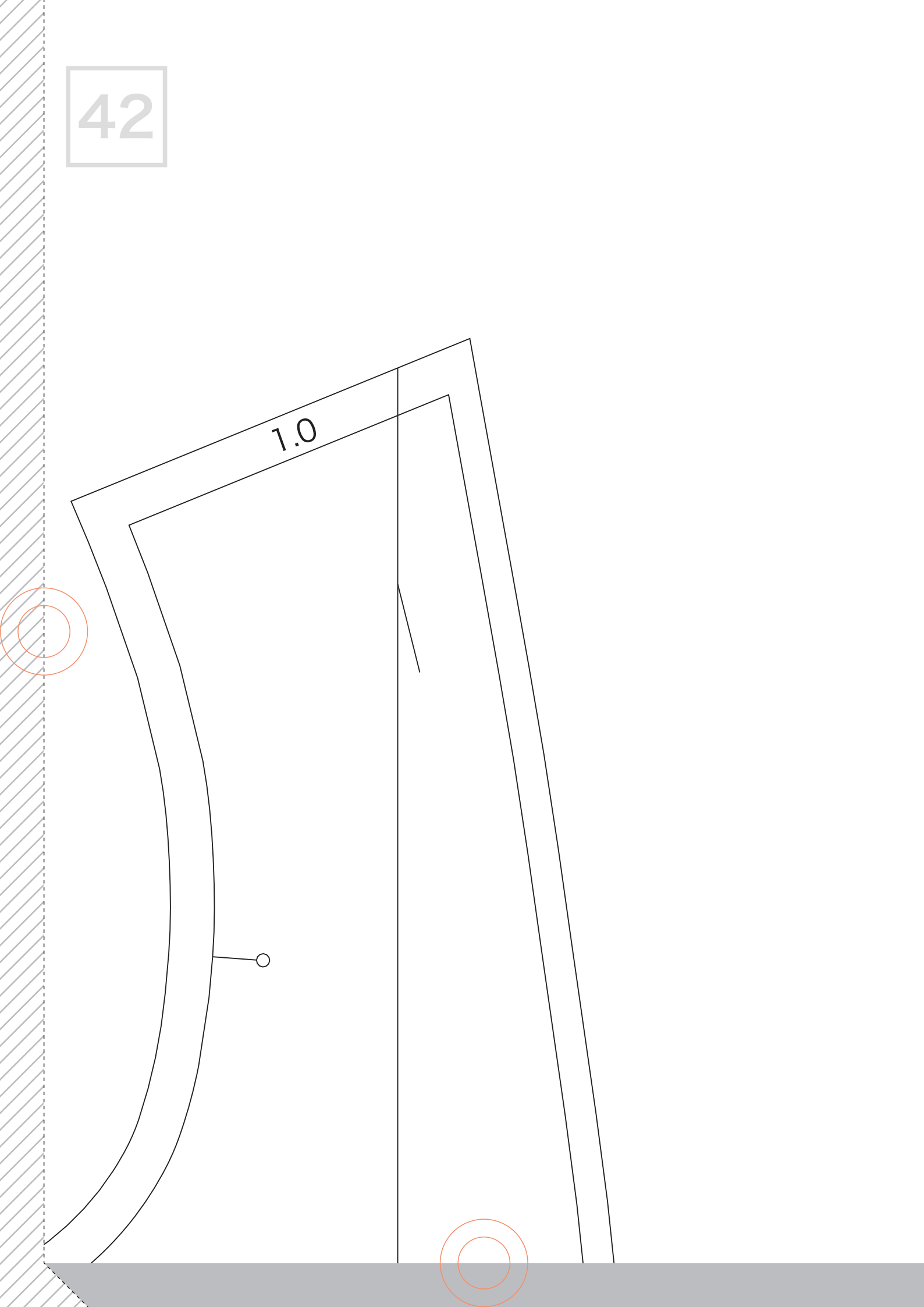

43

6mmバイヤステーブ始末 割り

1.5

f a b f a b - 1 3

内袖

size : 9

表×2枚

44

1.5

折り伏せ始末

1.5

折り伏せ始末

0.8cmステッチ

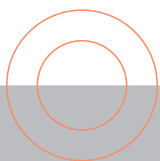
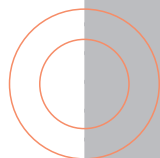
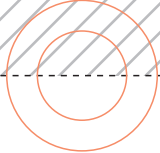
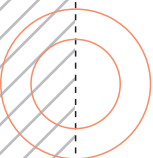

45

f a b f a b-13

外袖

size : 9

表×2枚

6mmバイヤステーナー始末 割り

1.5

46

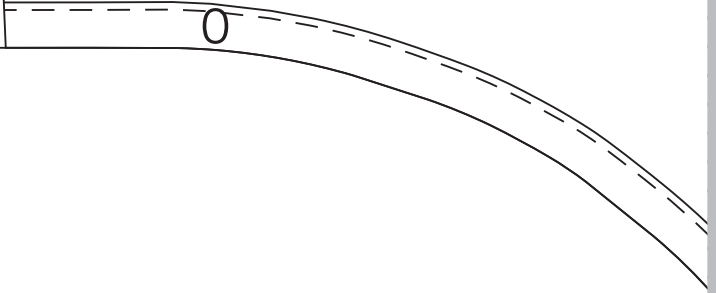
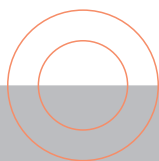
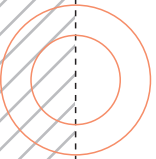
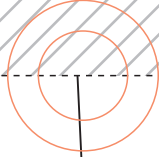

47

B

袖底

6mmバイヤステープ始末

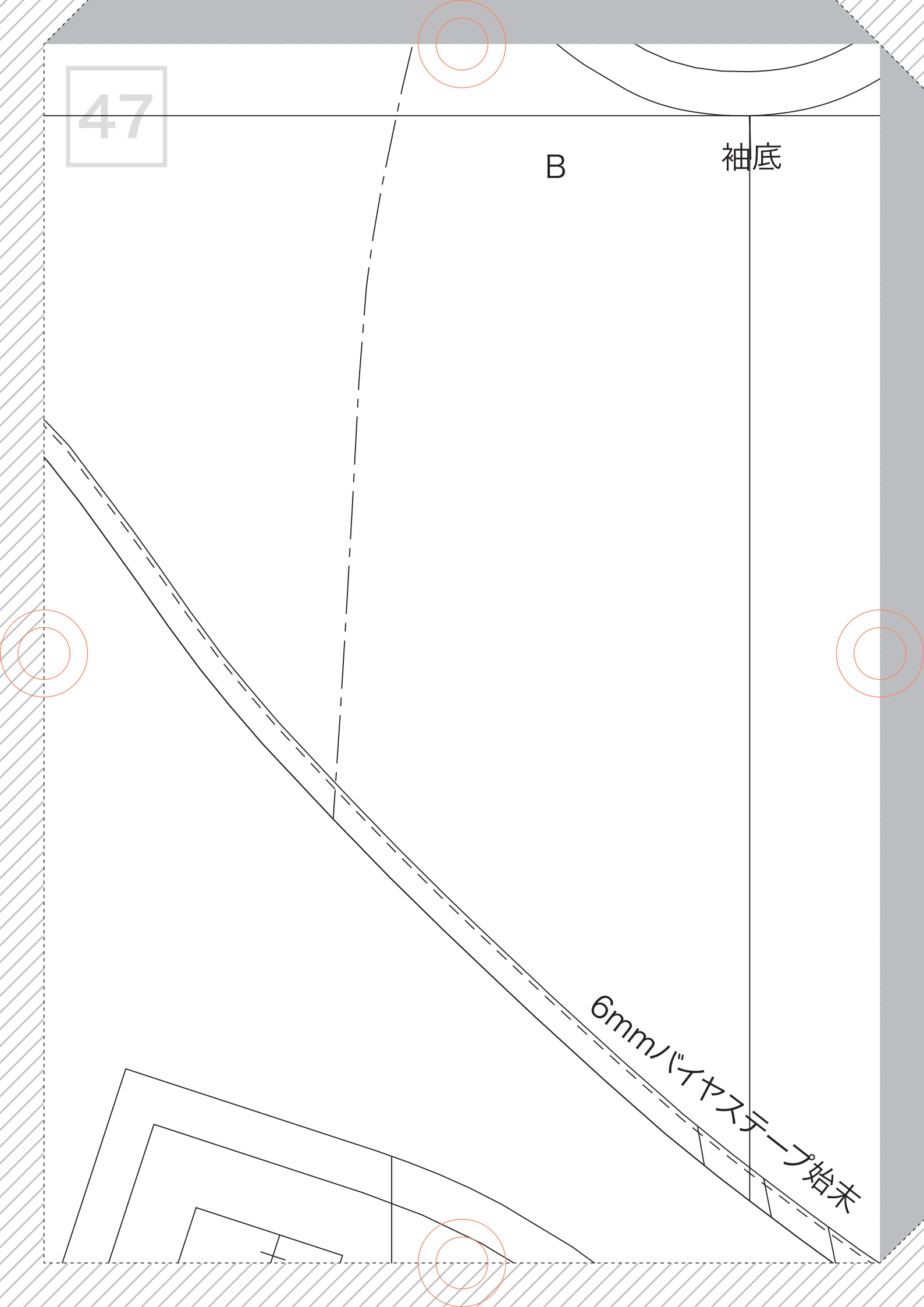



48

F

0.7

前見返しとはぐ

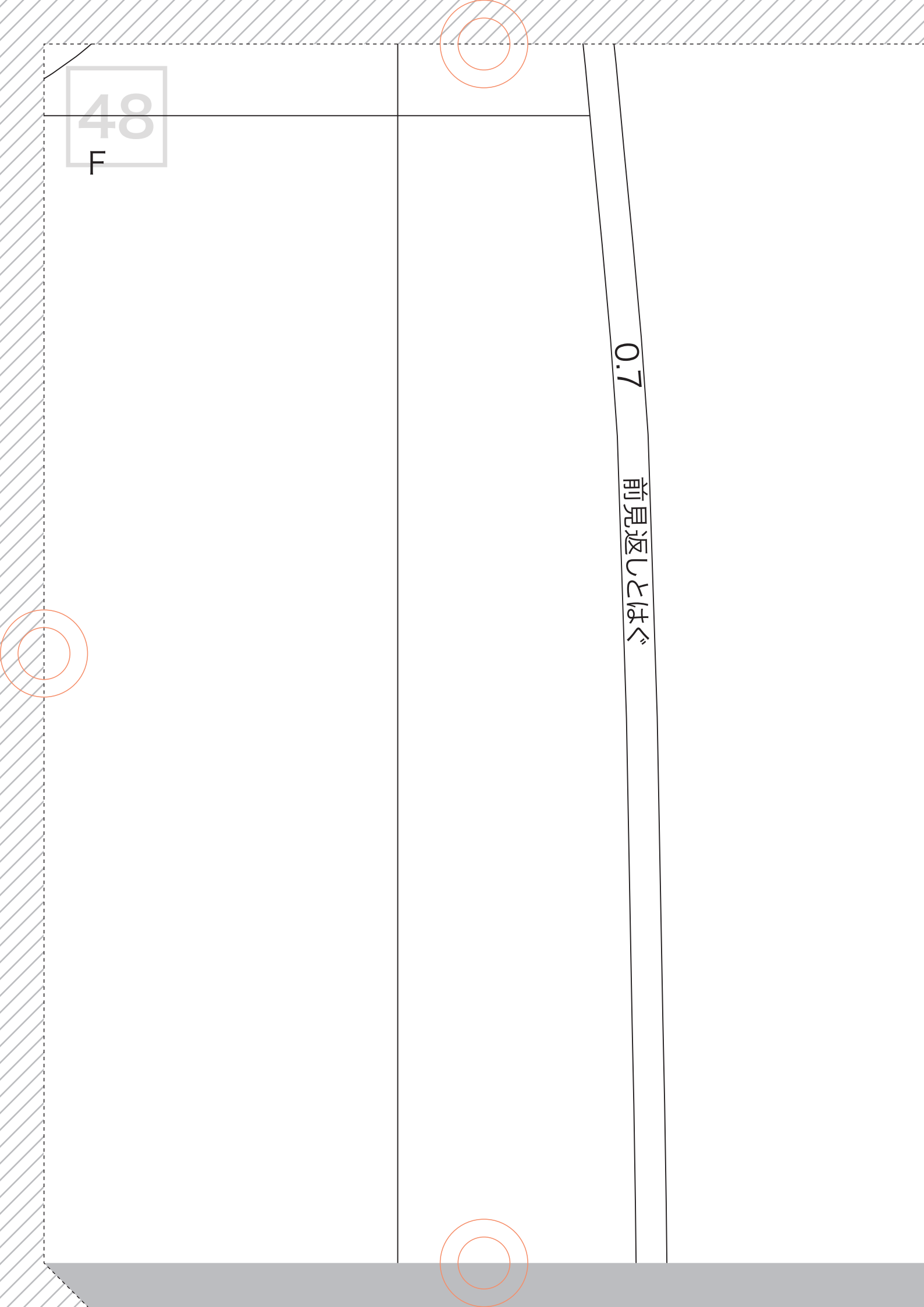

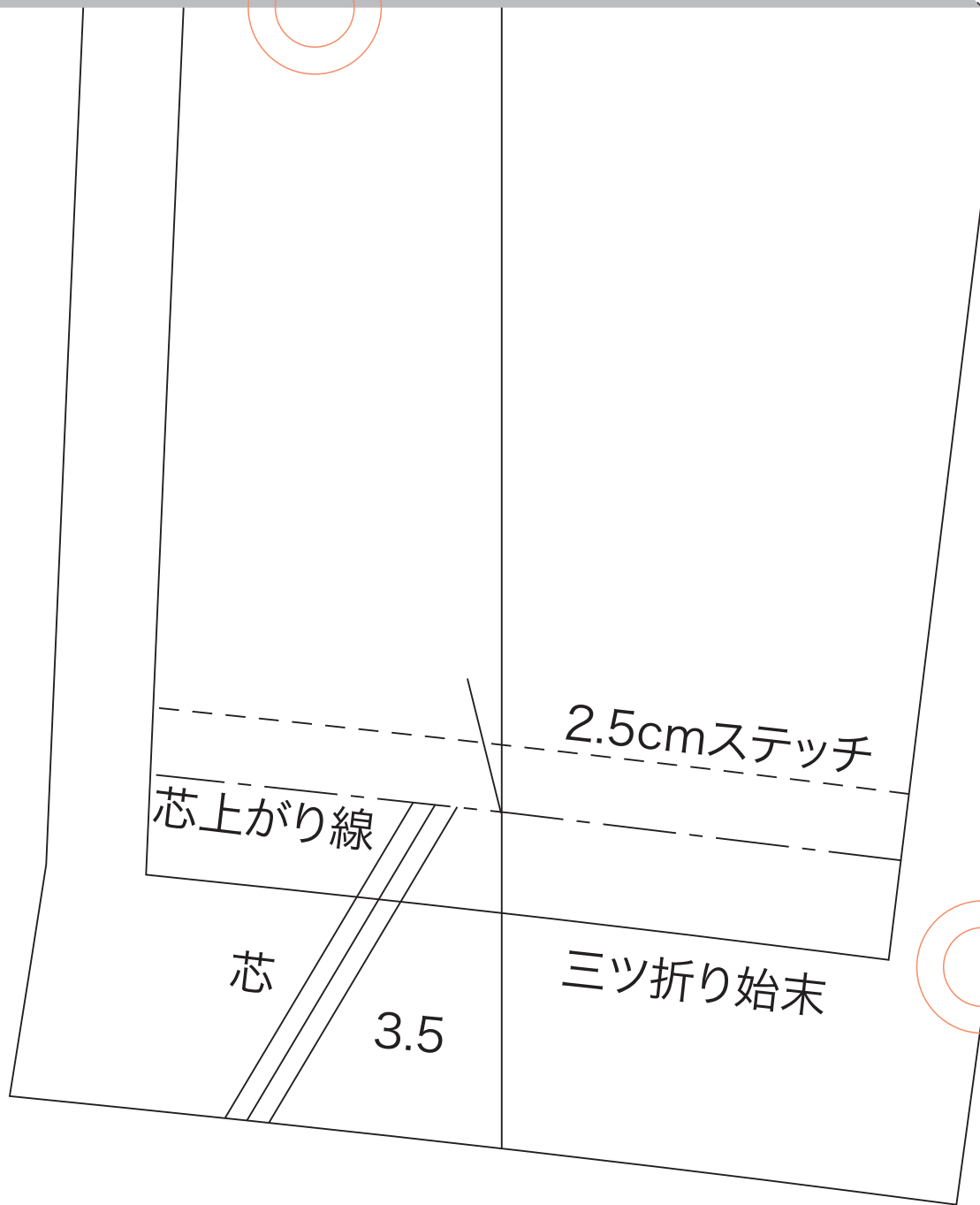

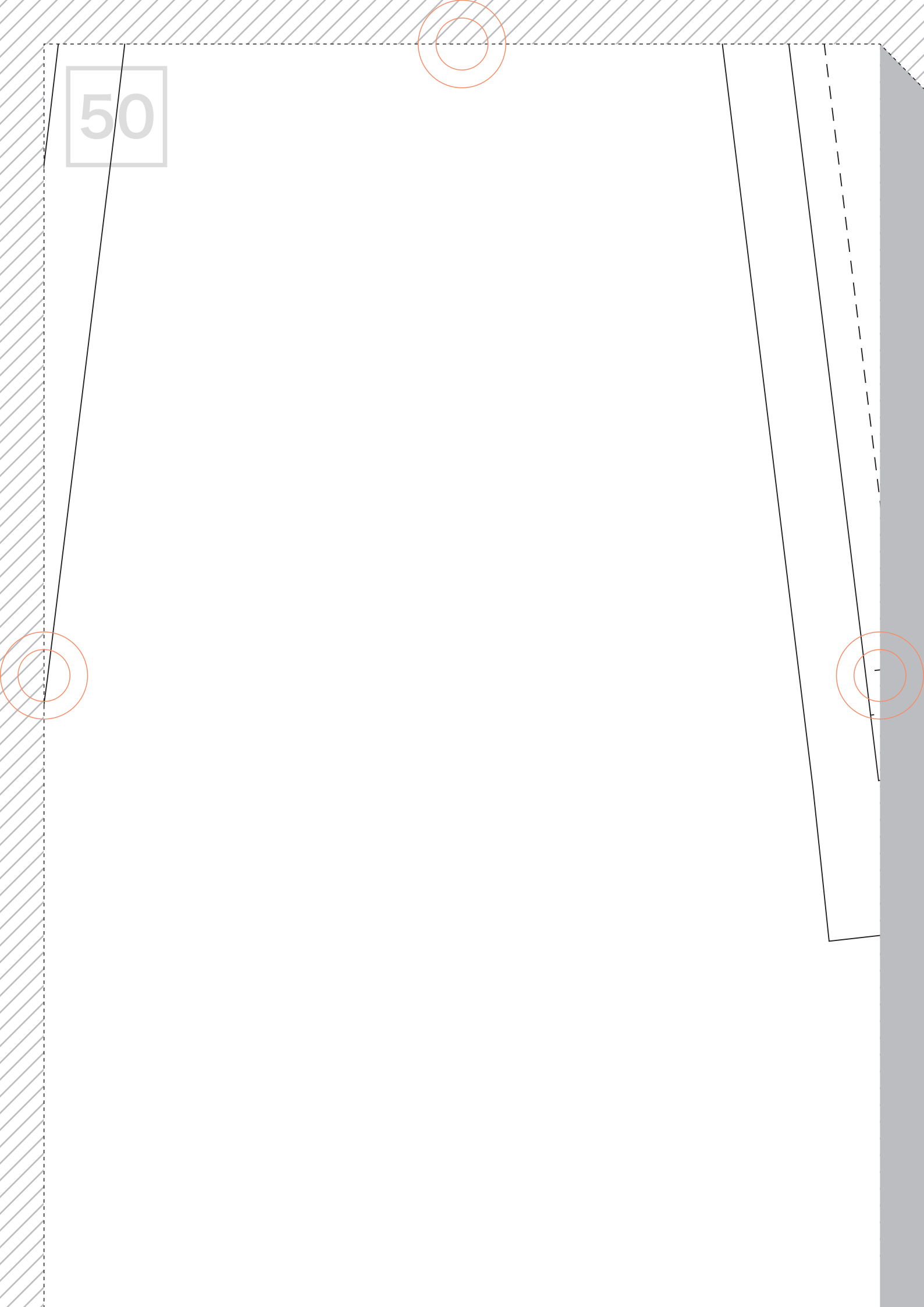

50

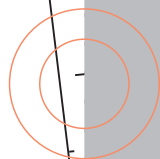
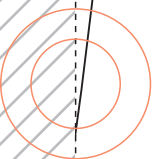
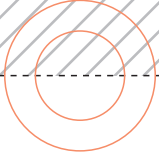

51

2.5cmステッチ

芯上がり線

三ツ折り始末

3.5

芯

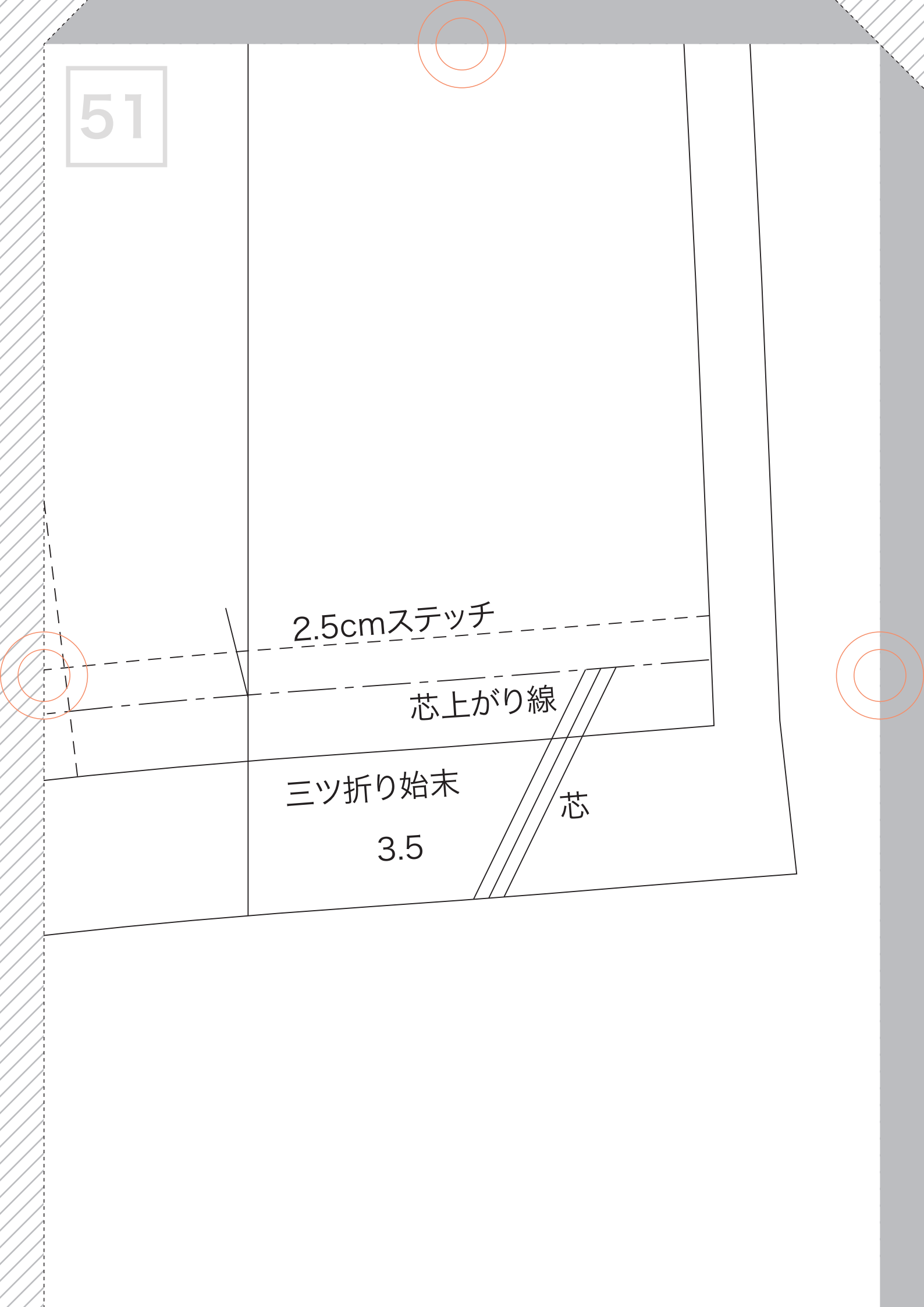

52

1.0

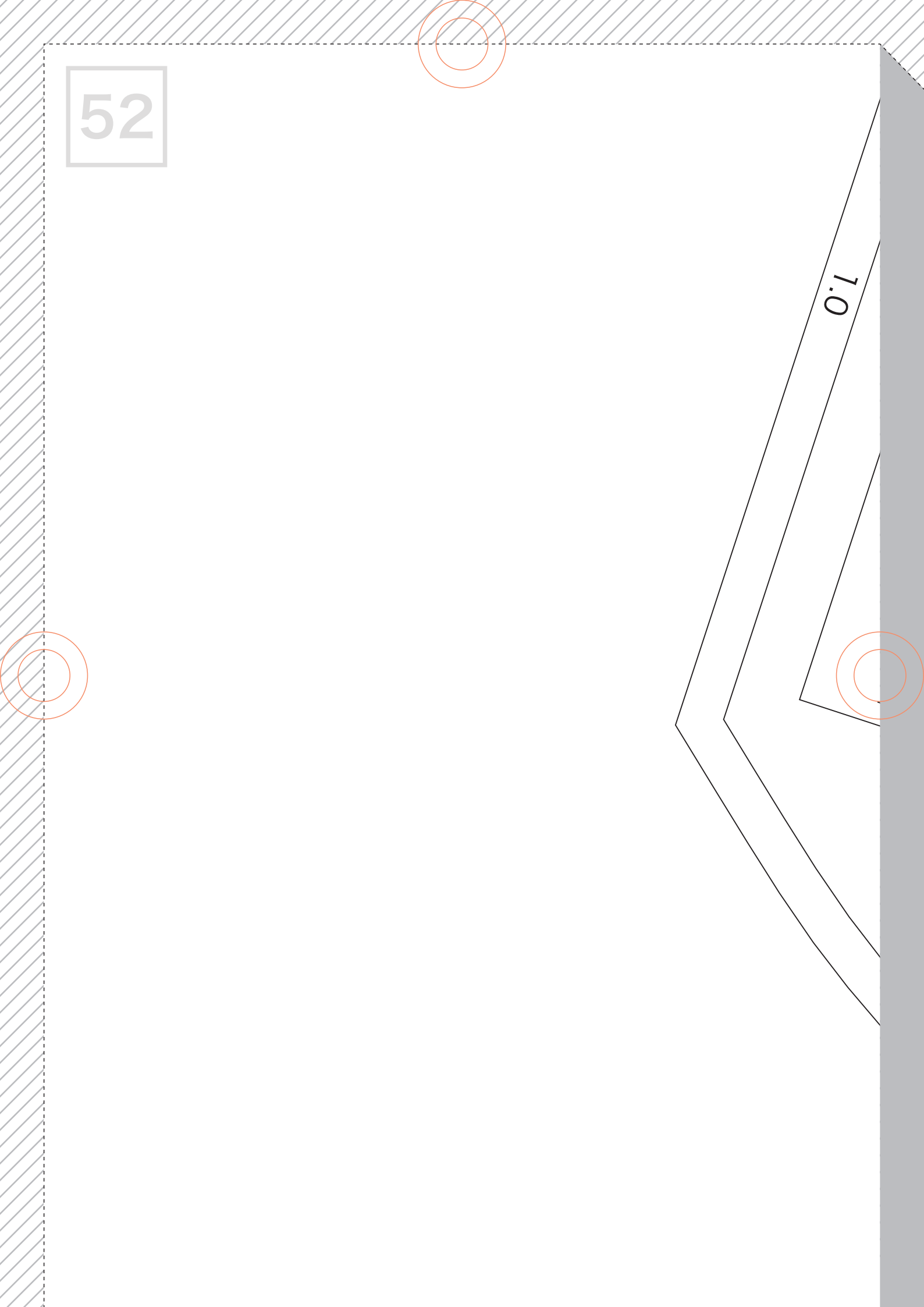

53

f a b f a b - 1 3  
箱ポケット袋布  
size : 9  
表×4枚

6mmバイヤステーブ始末

1.0

