

## introduction はじめに

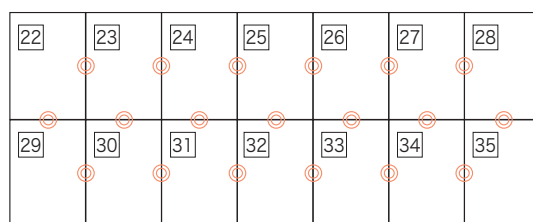
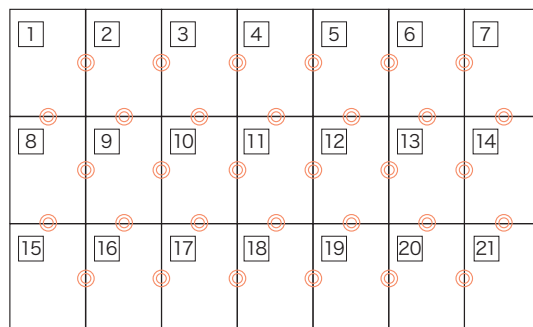

パターンは A4 サイズ 35 枚に分割されています。  
印刷後、右図のようにつなぎ合わせてください。

### ! 印刷時の注意

印刷設定では、「ページの拡大や縮小」を選択せず  
必ず、「実際のサイズ」(原寸) で印刷してください。



## how to make パターンのつくりかた

**STEP1** 斜線部分  は切り取り、灰色部分  は残してのりしろにします。  
(斜線と灰色を間違えないように注意)

**STEP2** 各用紙の番号を確認し、 の位置を合わせて、のりづけします。  
(水のりは用紙が波打ちます。スティック糊などをお使いください)

**STEP3** それぞれのパーツをハサミで切り出します。

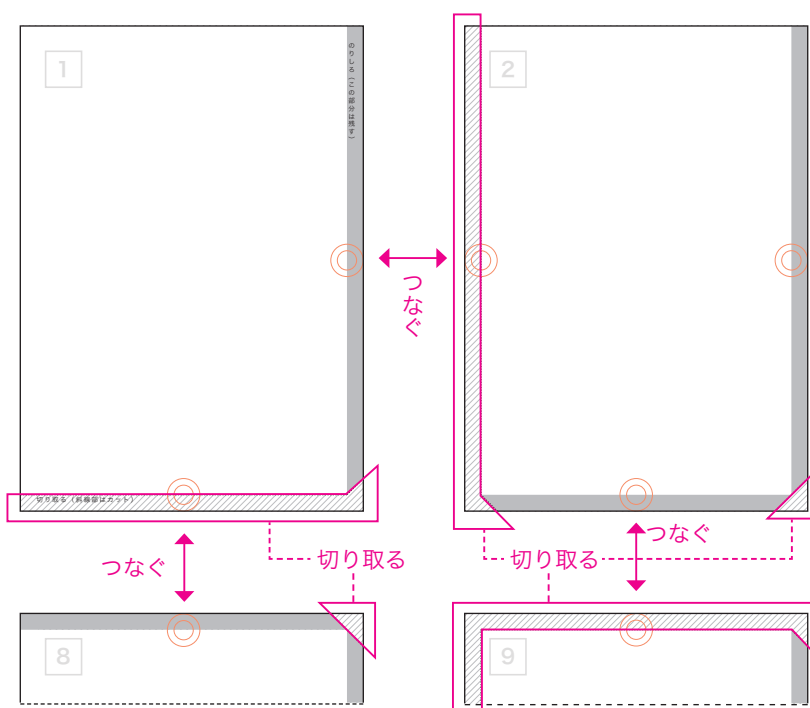

のりしろ (この部分は残す)

1

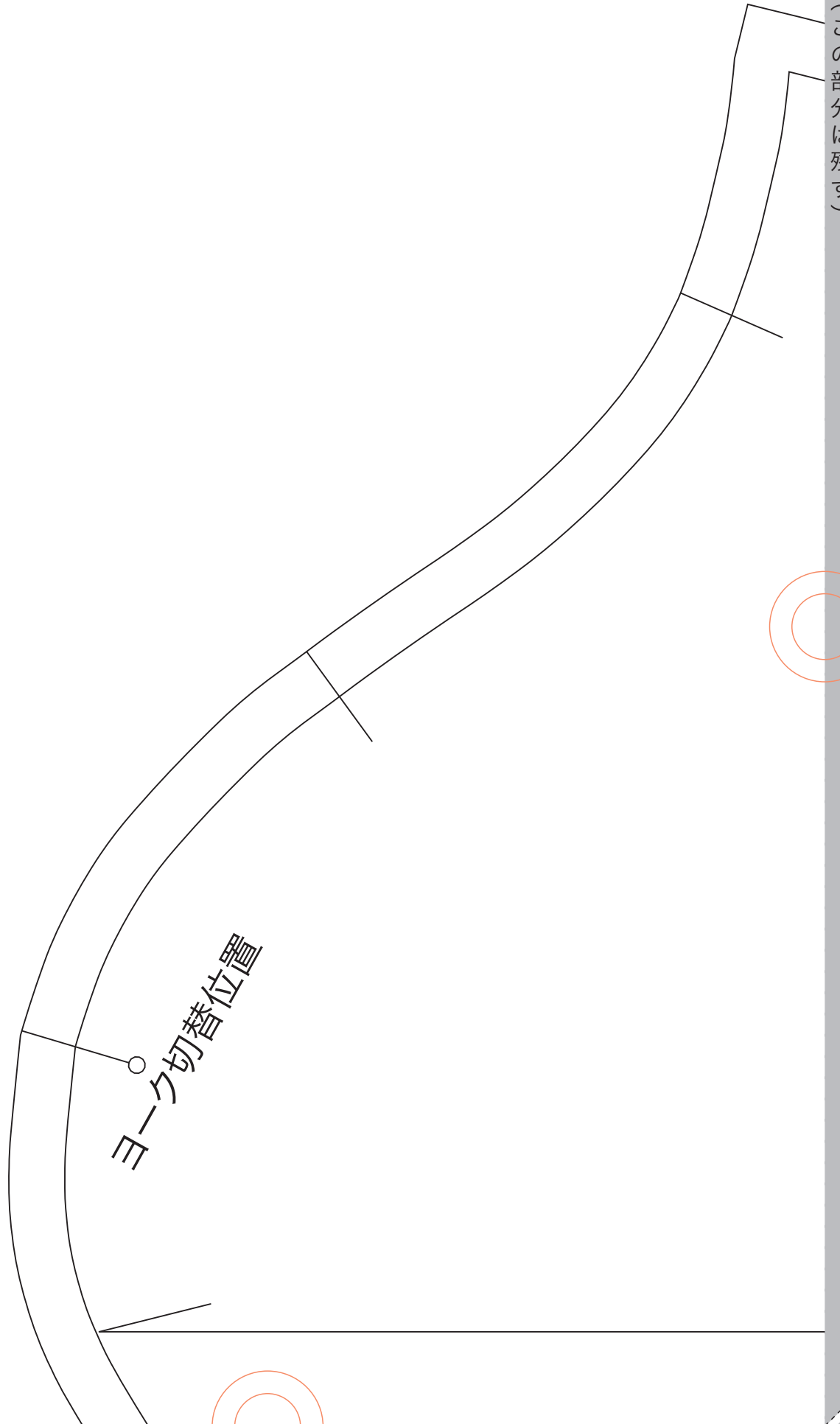

切り取る (斜線部はカット)

2

1.0

前

fabfab-15

袖

size: 11

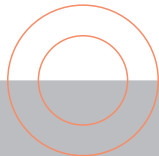
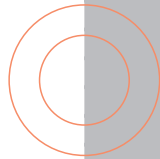
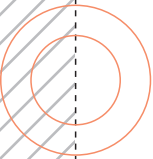

3

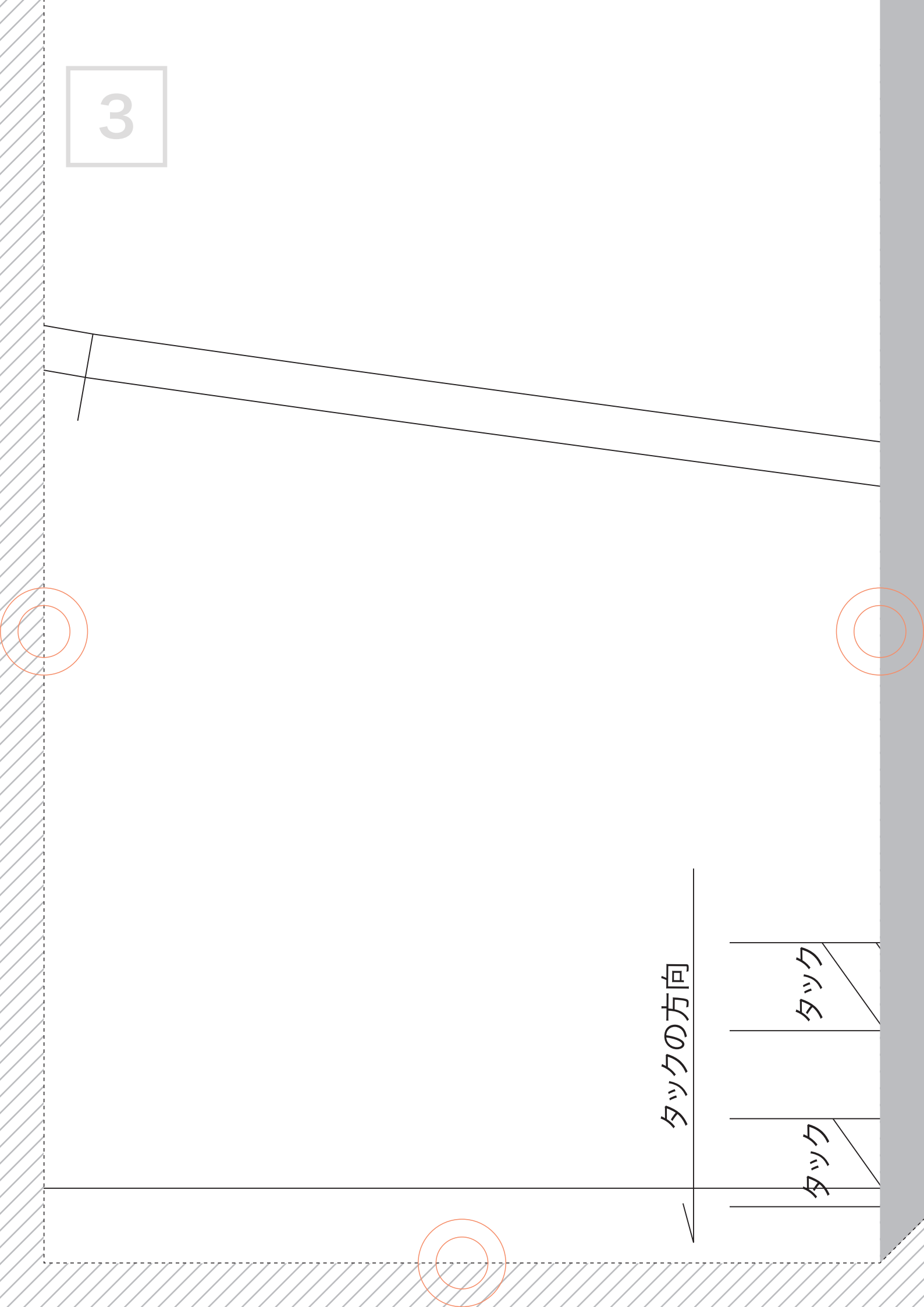

タツクの方向

タツク

タツク

4

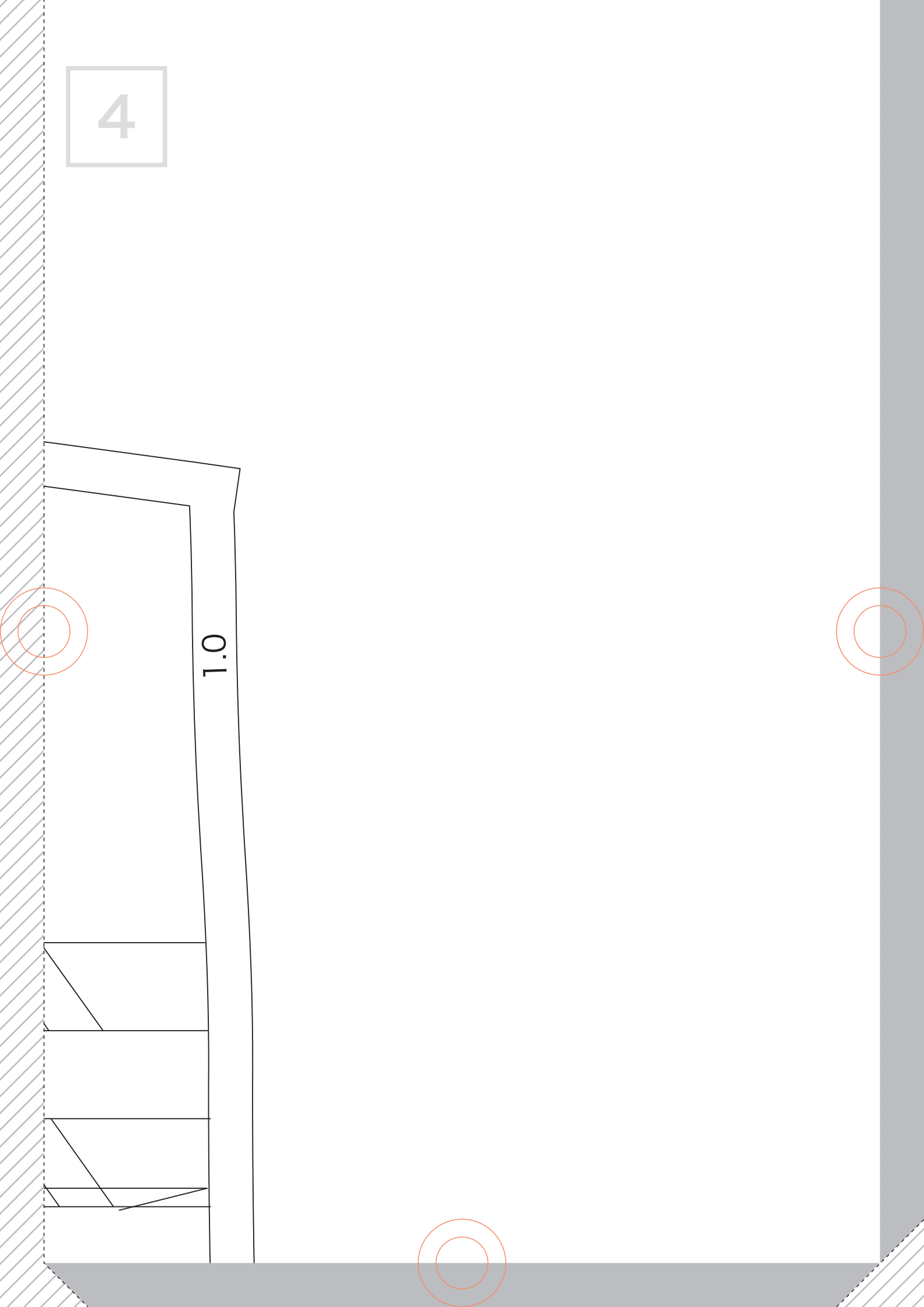

1.0

5

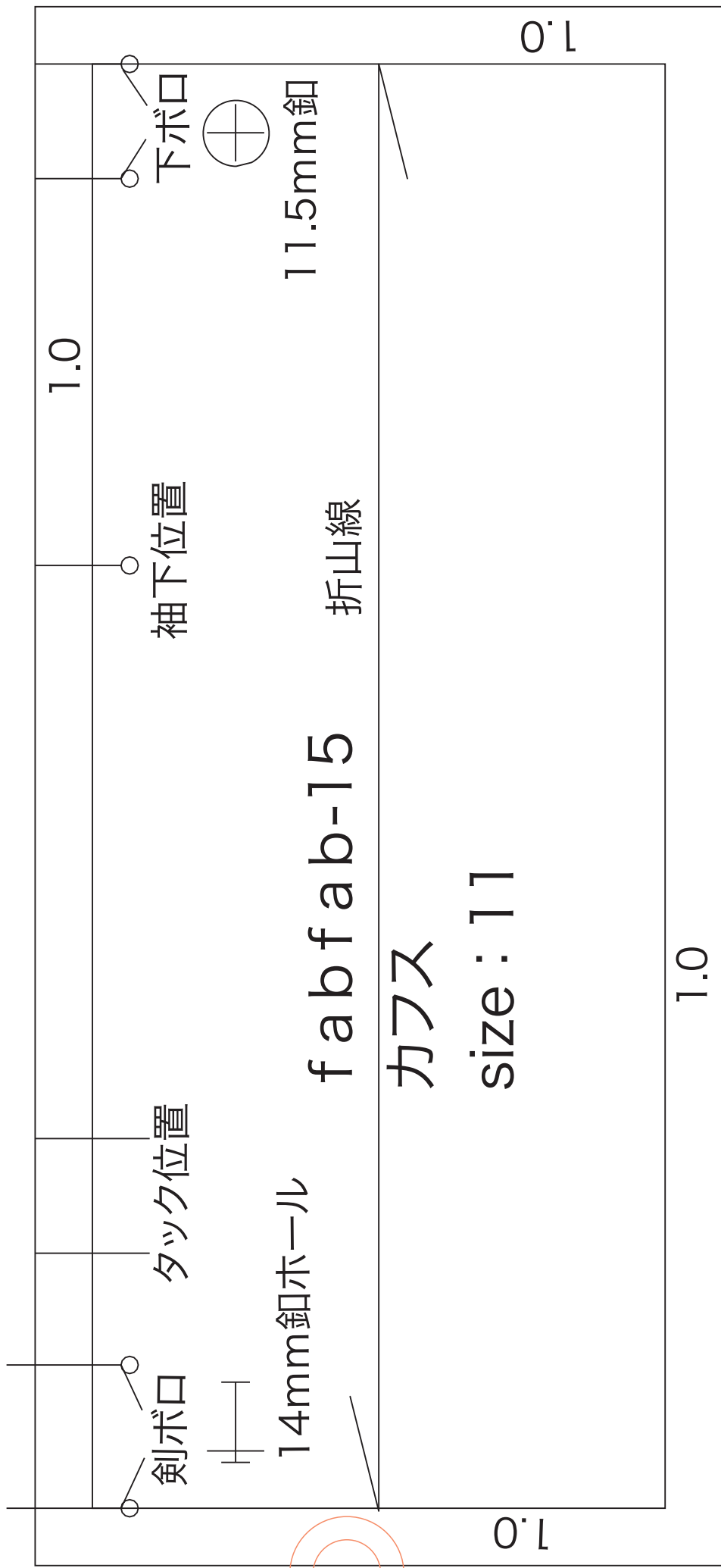

6

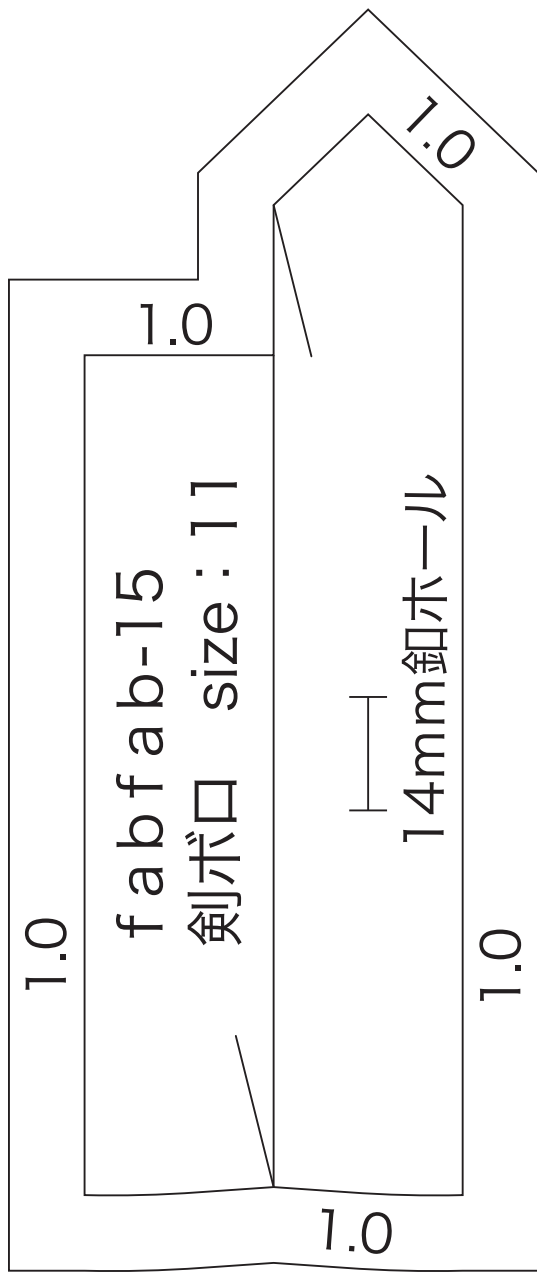

7

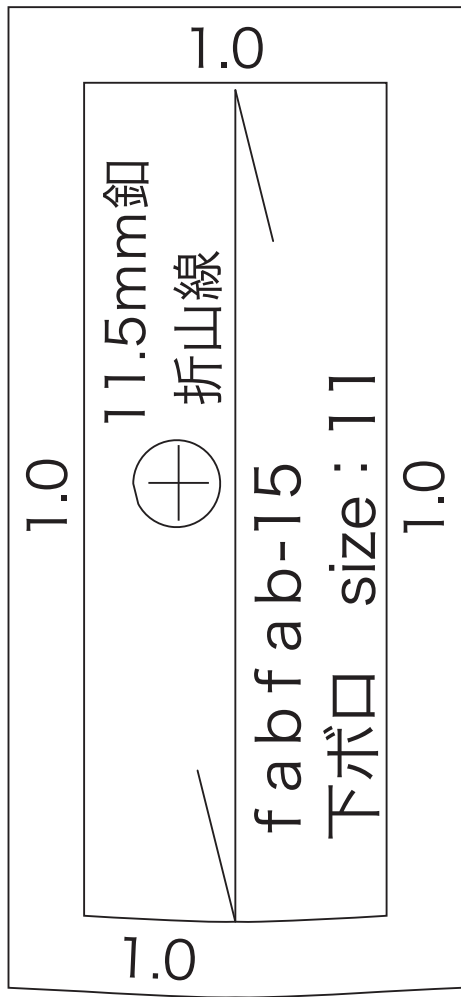



8

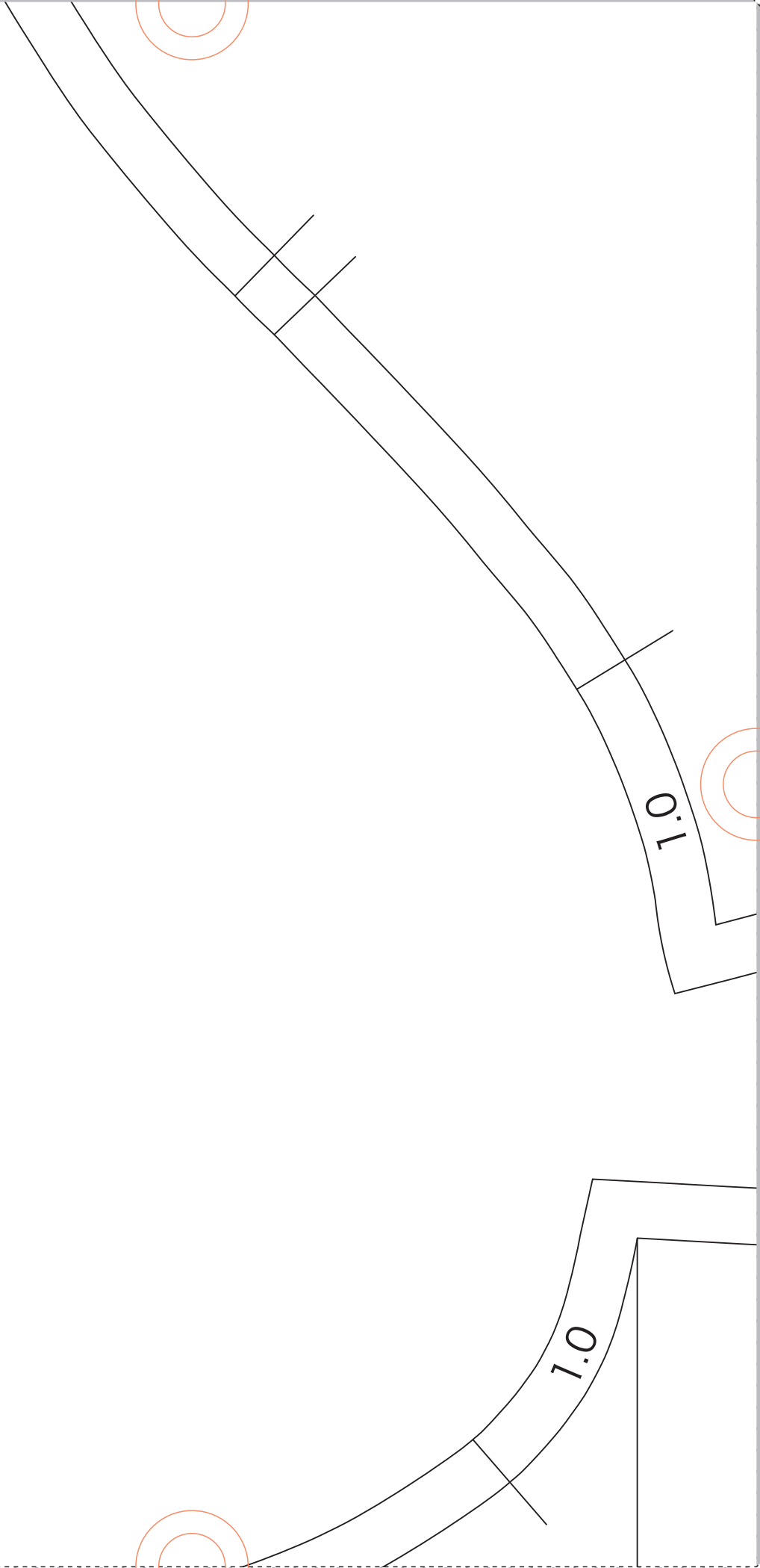

9

後ろ

0.1

1.0

ボール通し位置

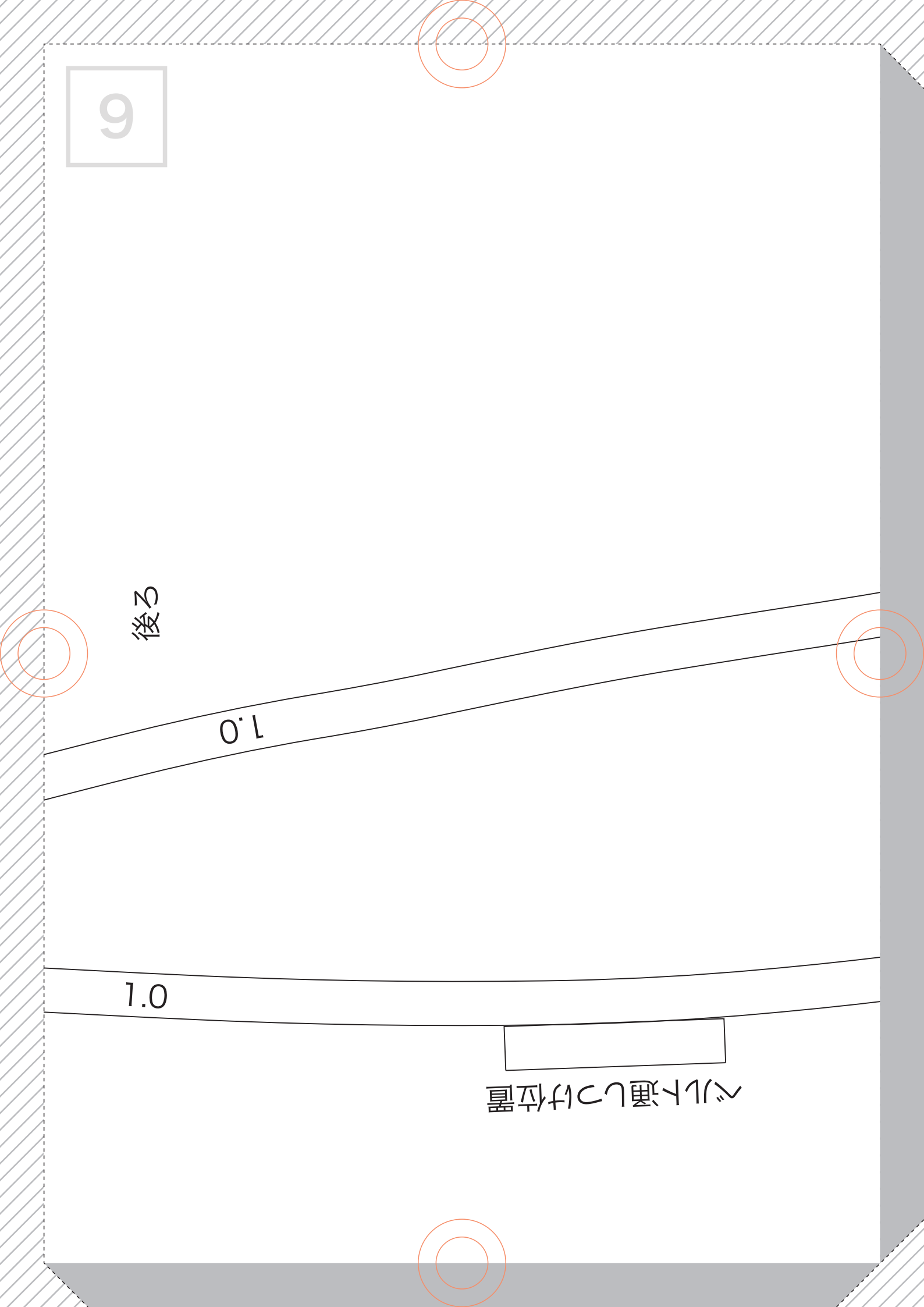

10



切込み位置

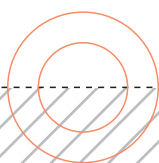
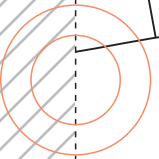

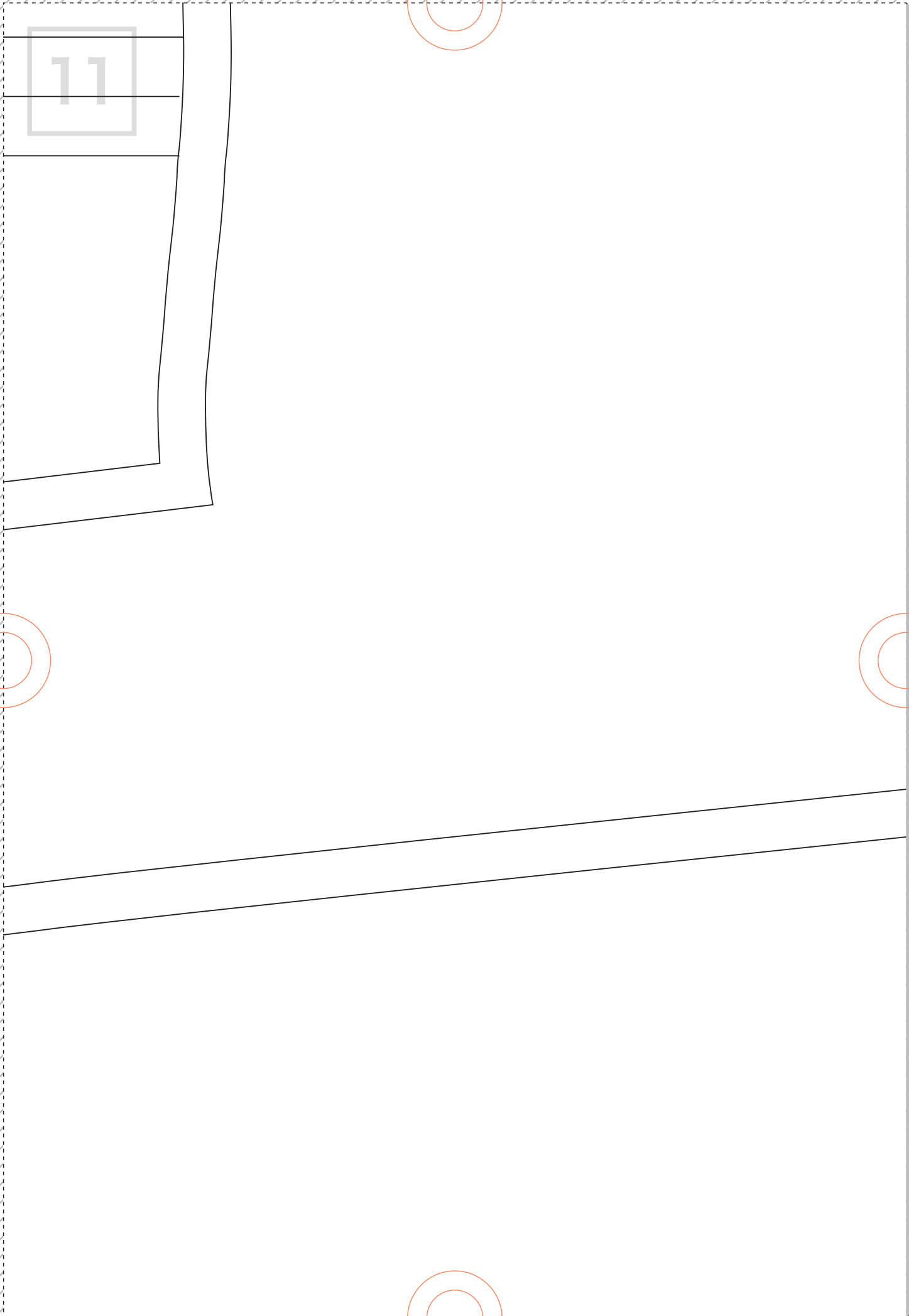

11

12

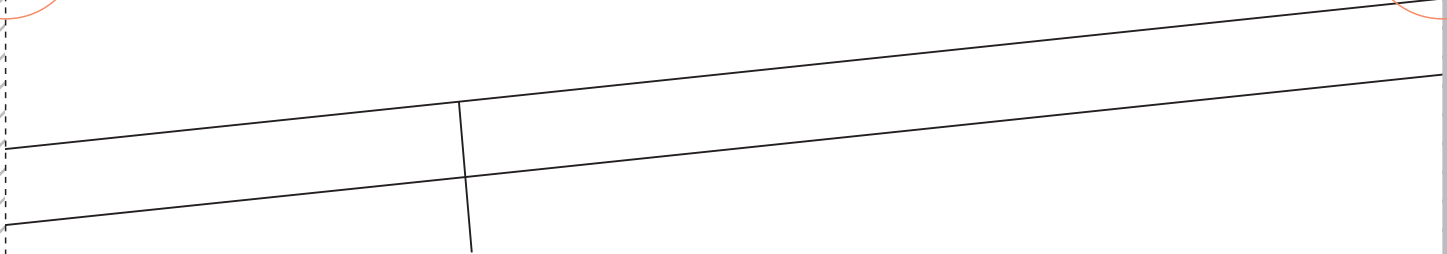
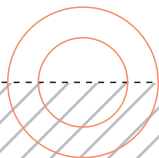
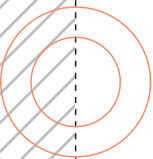
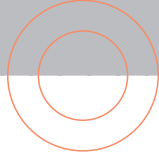

13

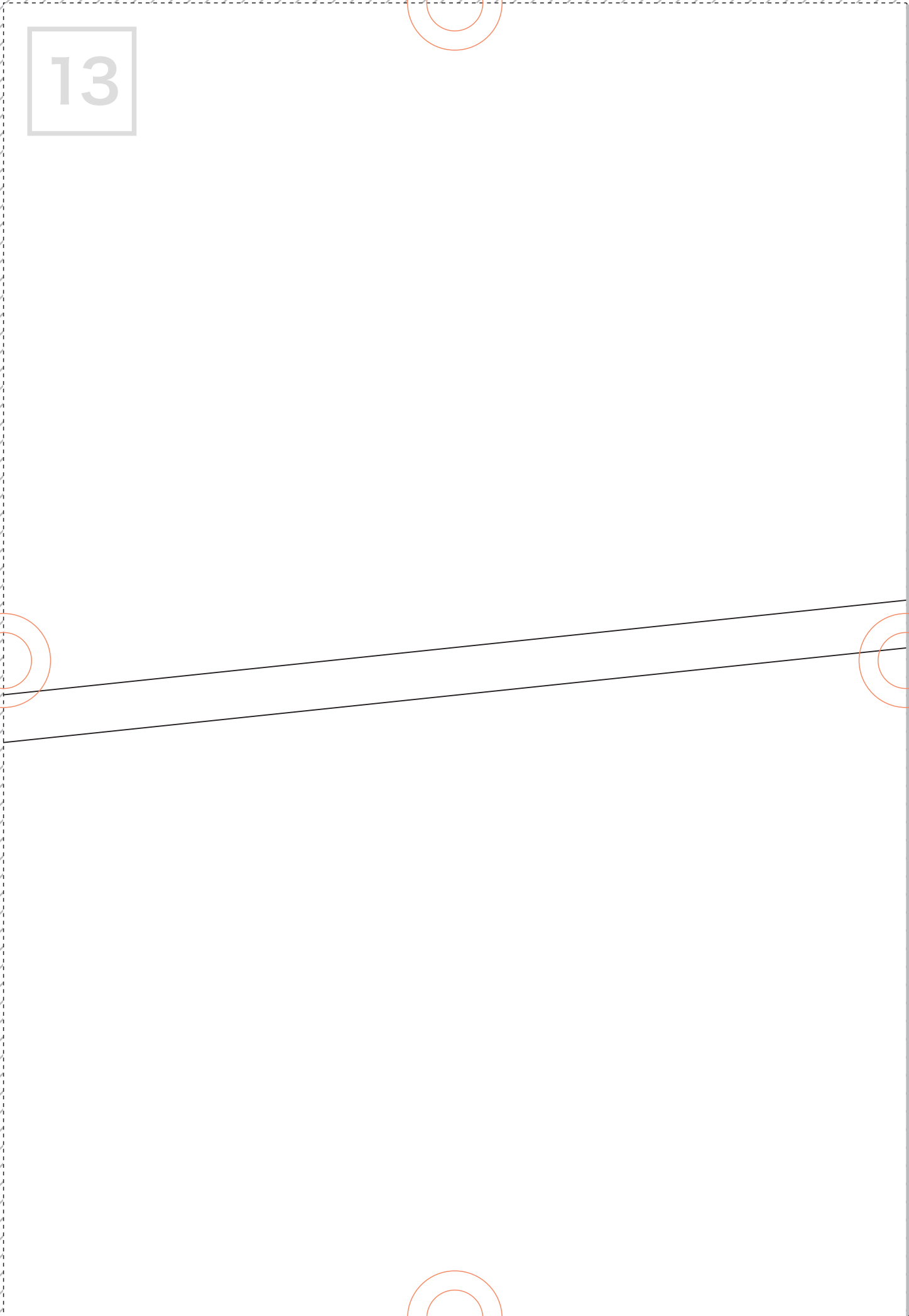
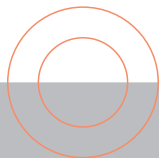
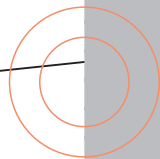
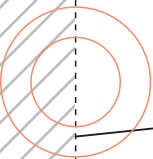
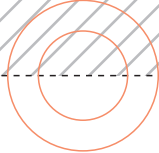

14

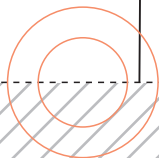
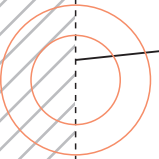
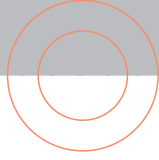

切替位置

N.P



15

1.0

タック

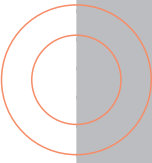
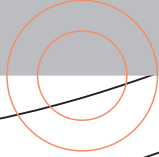



16

fabfab-15

後ろ

size : 11

後ろ中心わ

17

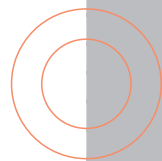
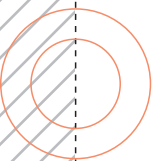
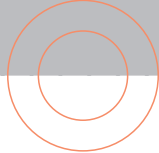

18

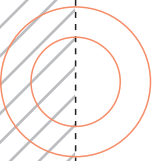
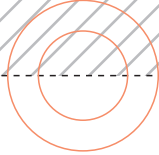

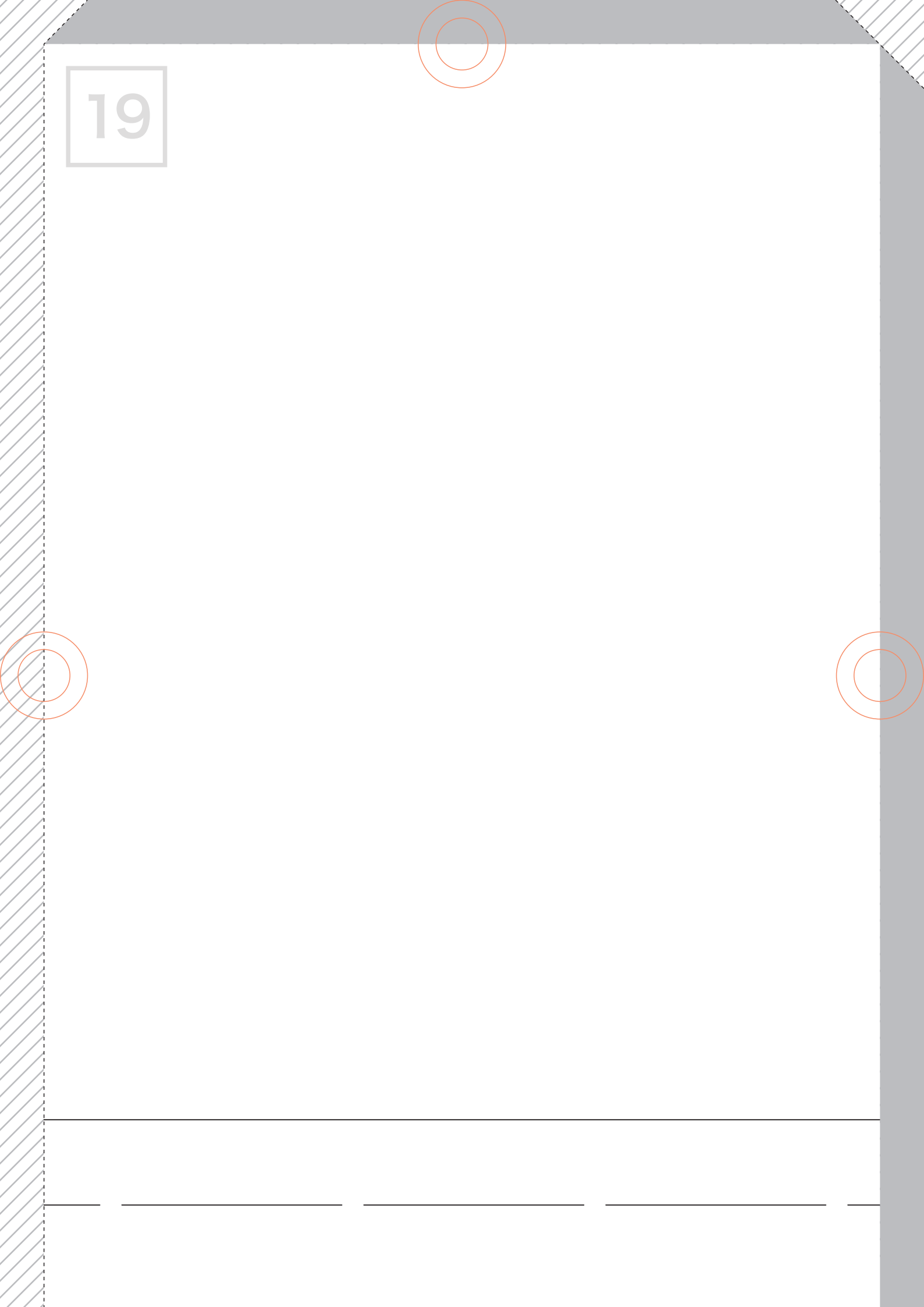
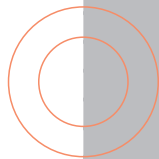
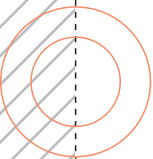
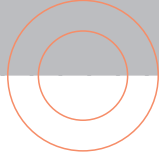

20

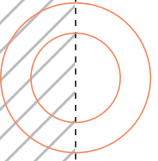
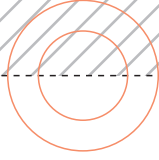

21

3.5

1.0

size : 11

fab fab-15

衿

1.0

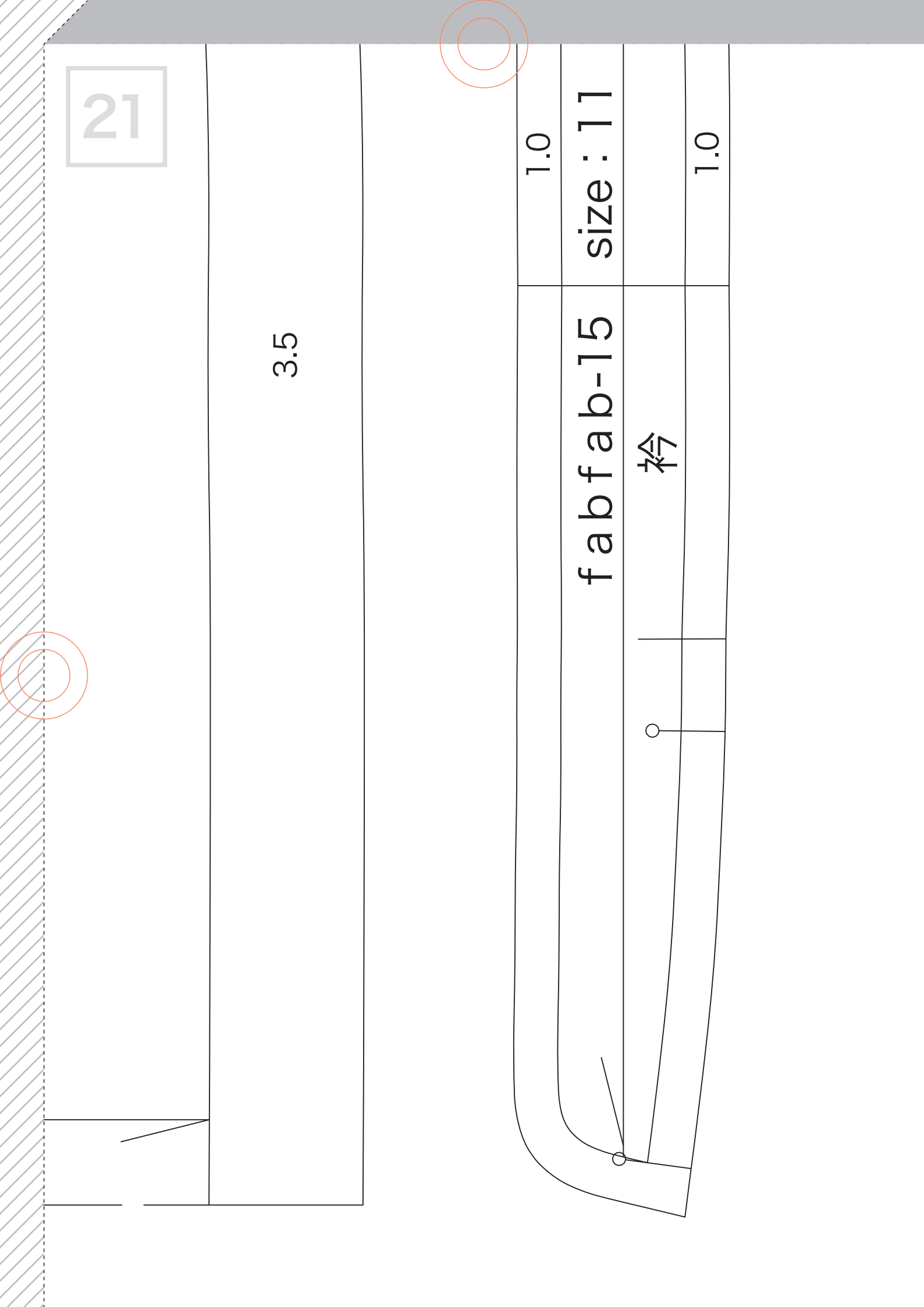
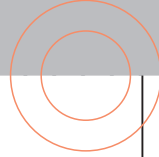
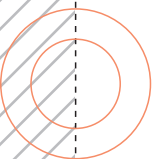

22

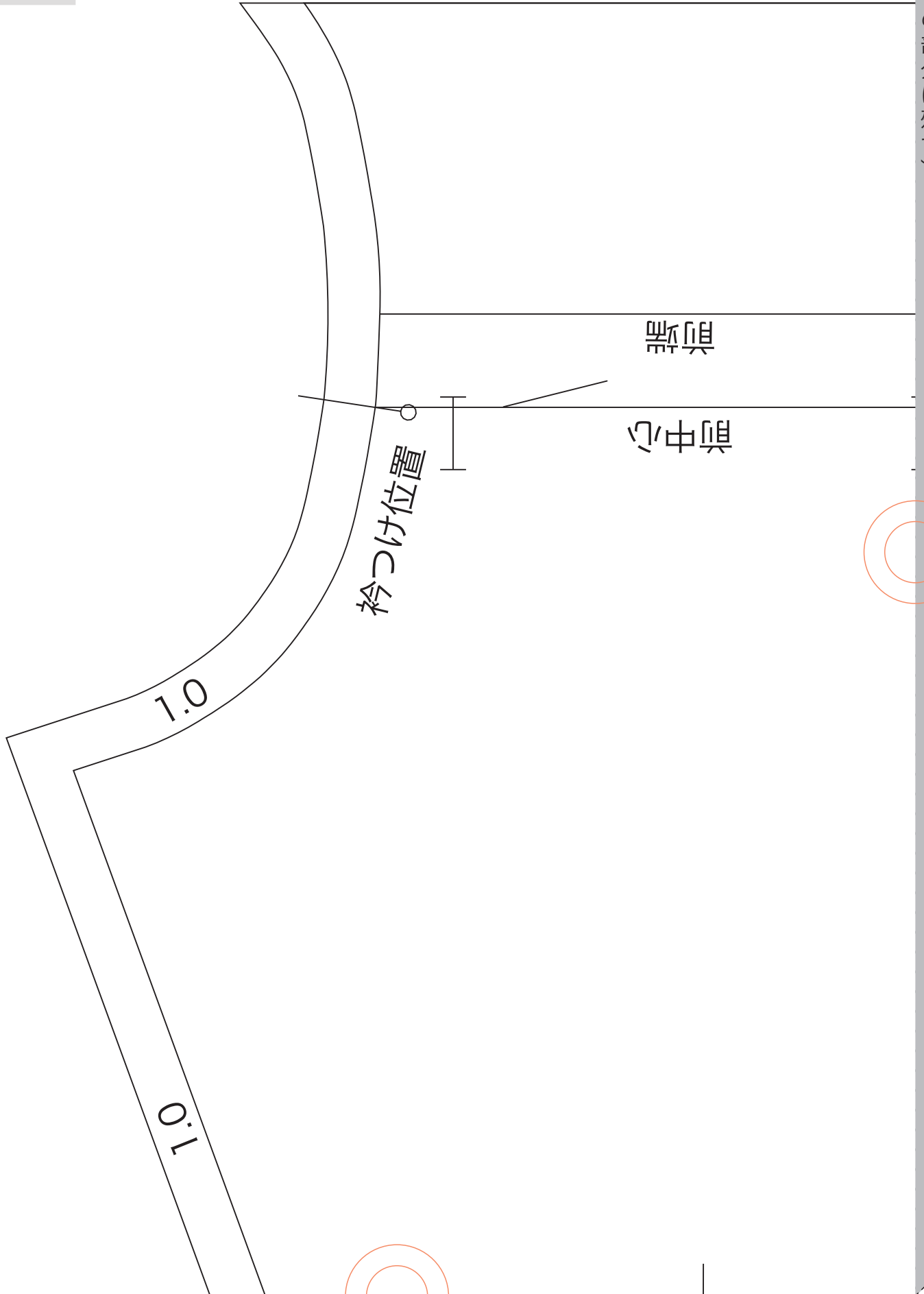

切り取る (斜線部はカット)

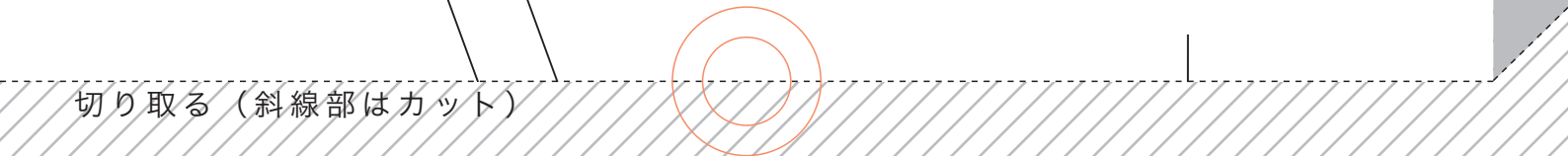

23

見返し

fabfab-15

前

size : 11

11.5mm釘  
14mm釘ホー儿

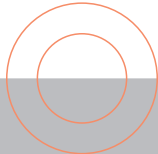
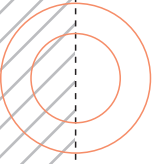



24

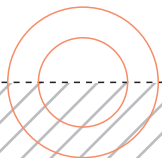
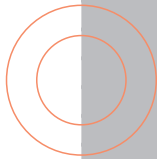
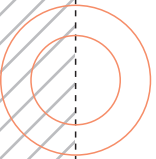
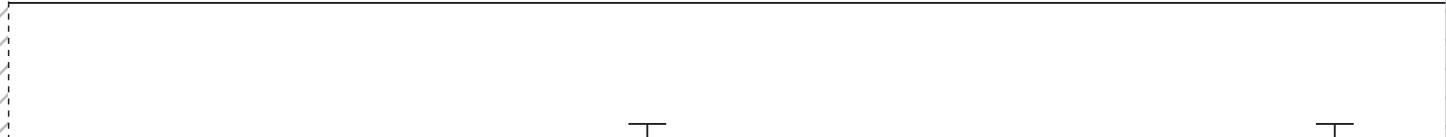
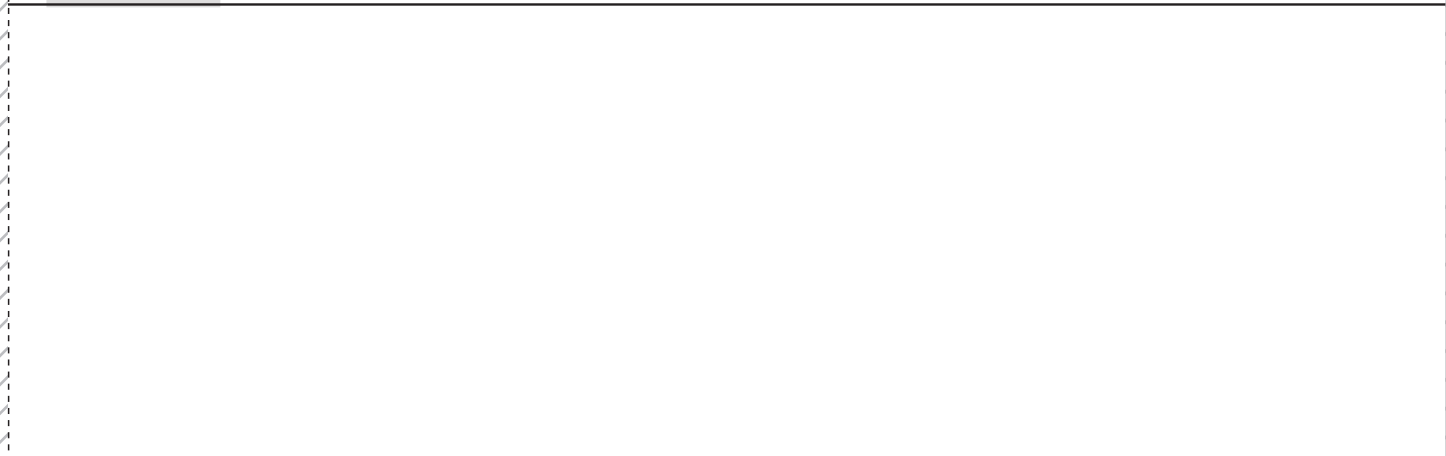

25

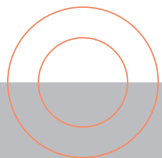
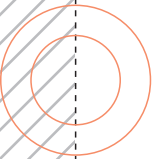

26

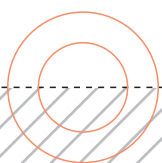
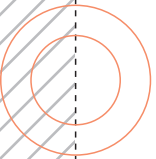
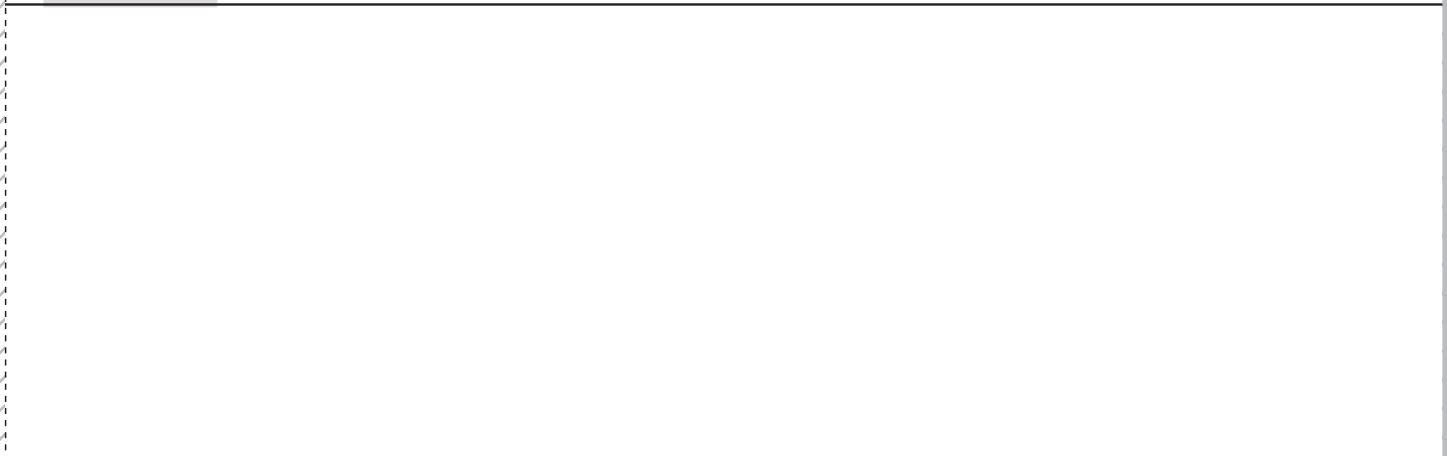

27

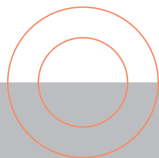
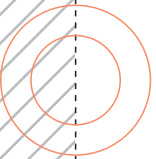

28

3.5

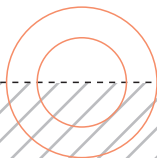
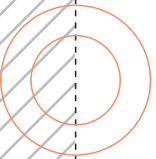

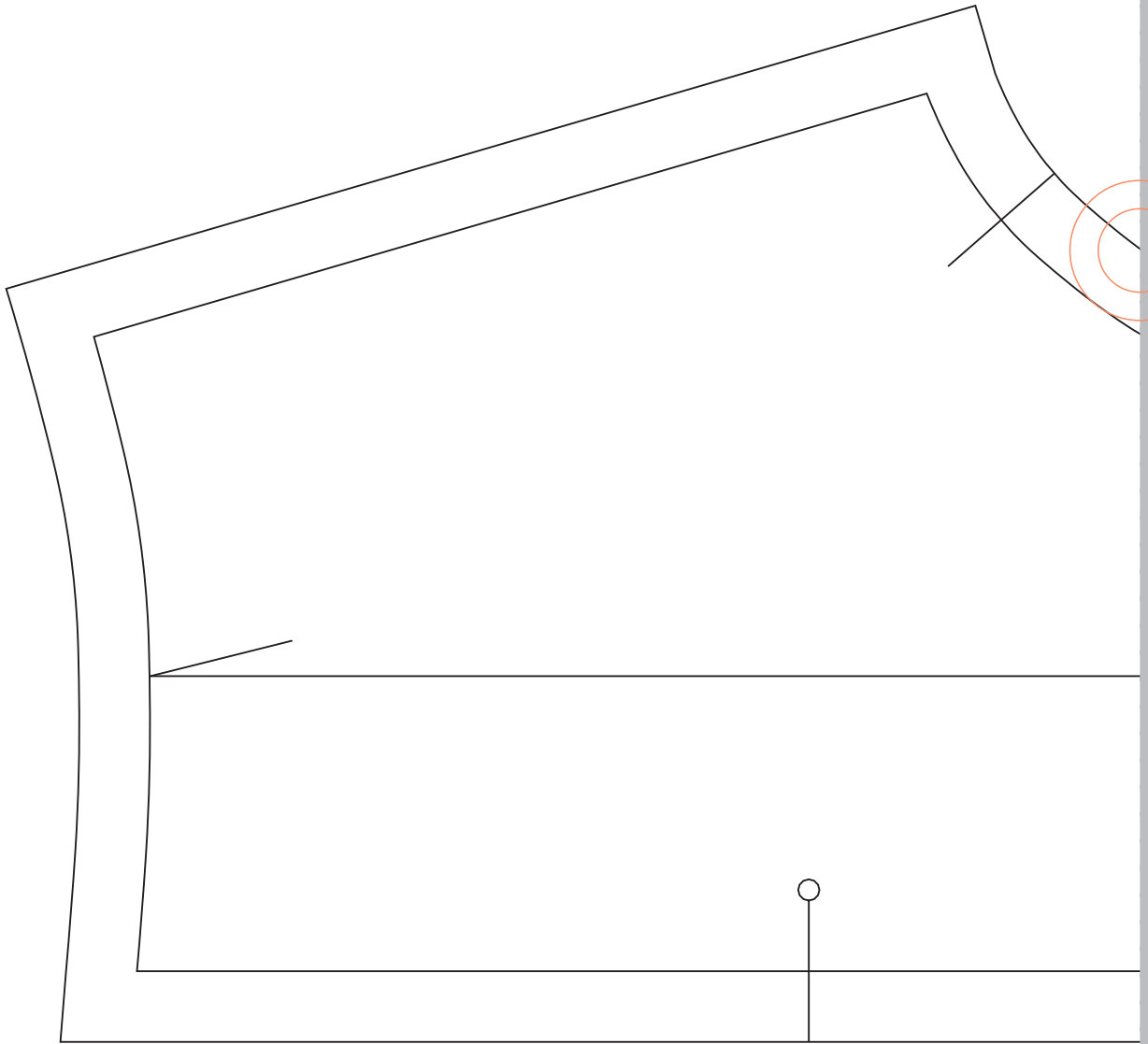

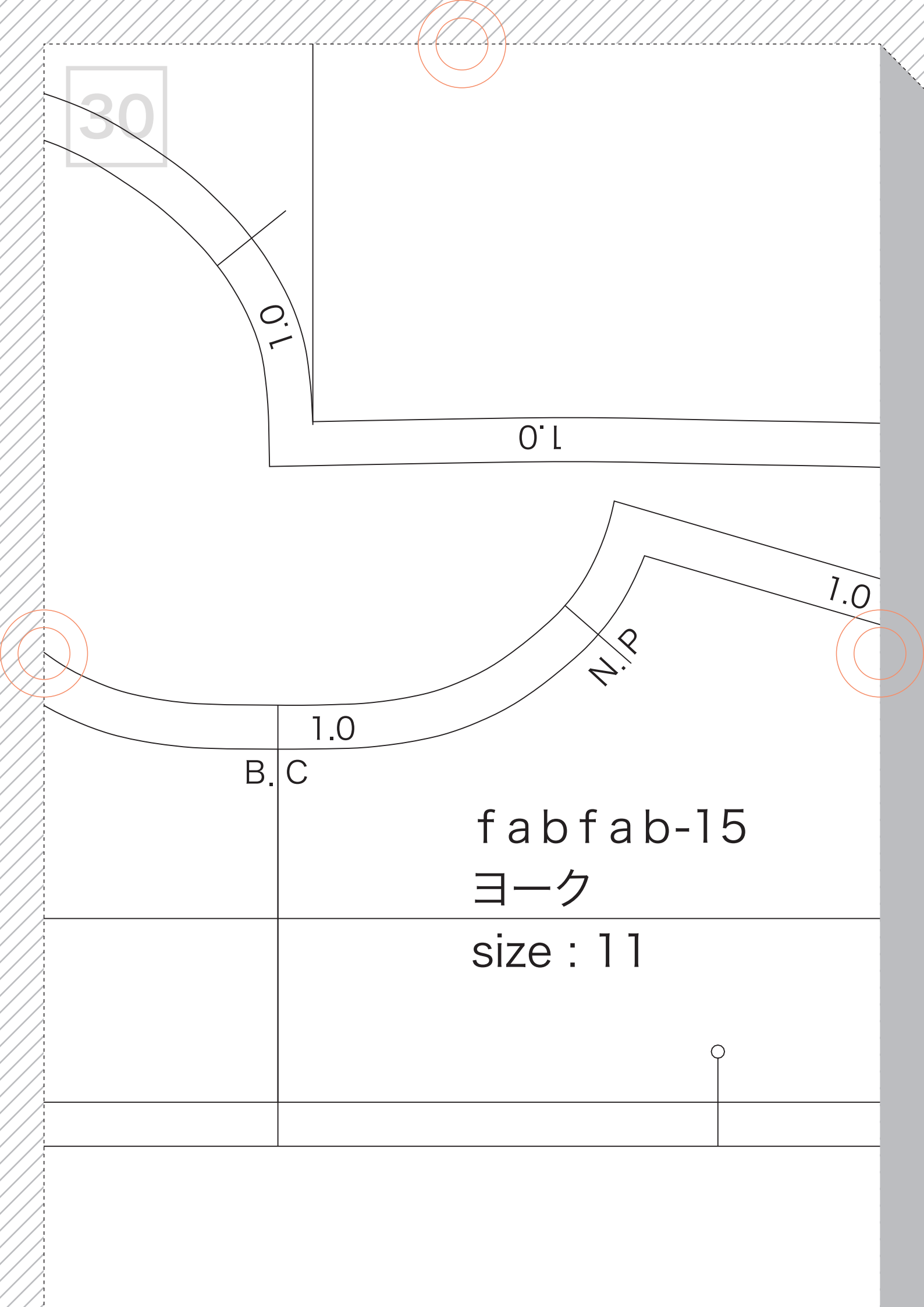

31

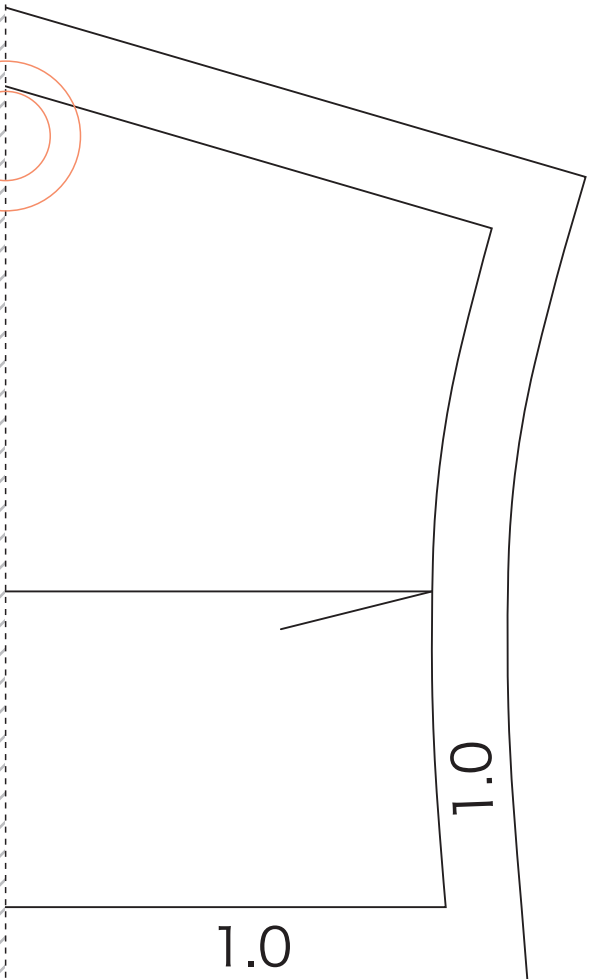
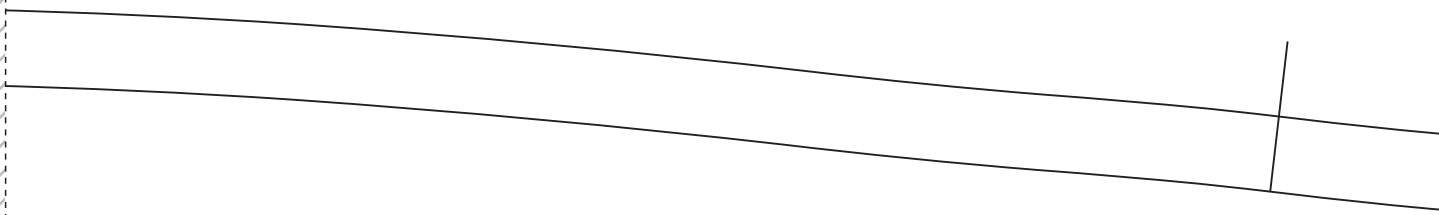
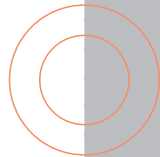
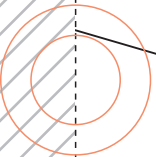
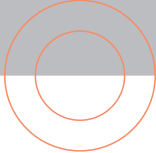



32

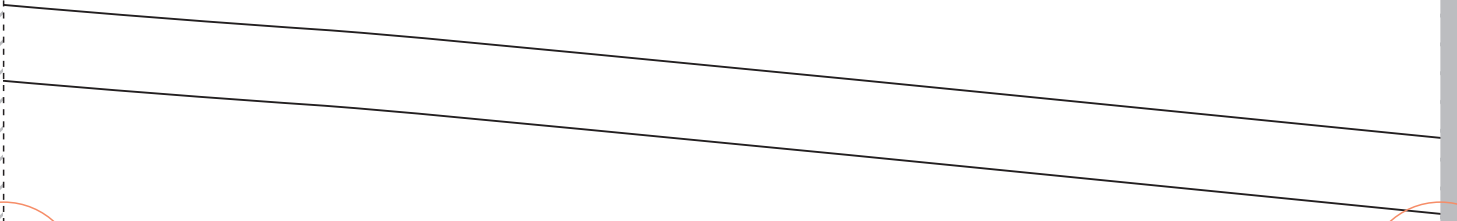
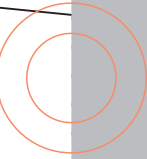
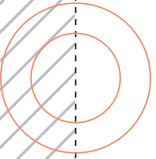
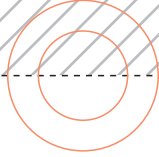

33

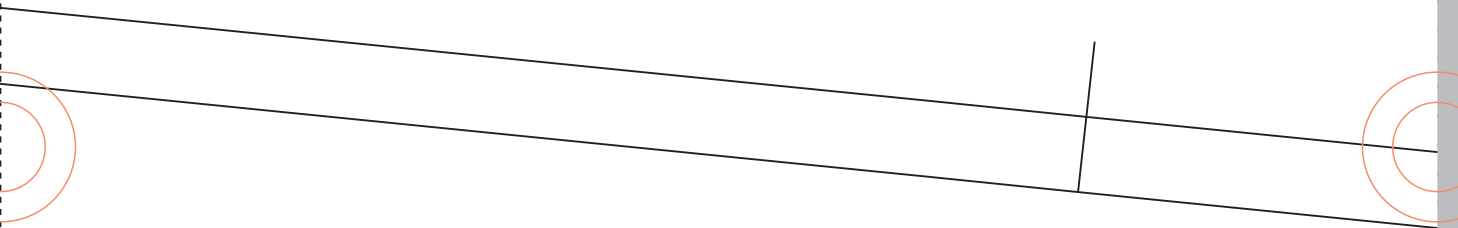
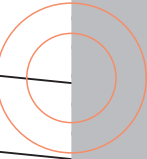
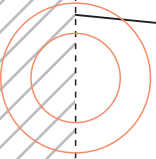
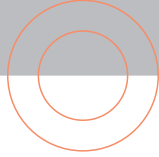

34

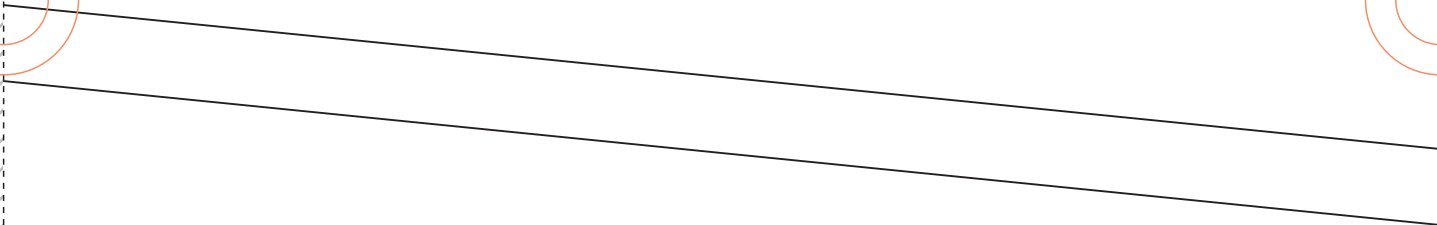
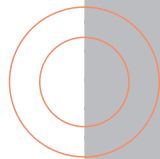
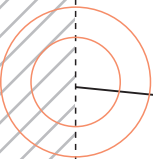
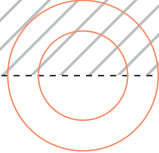

35

