

introduction はじめに

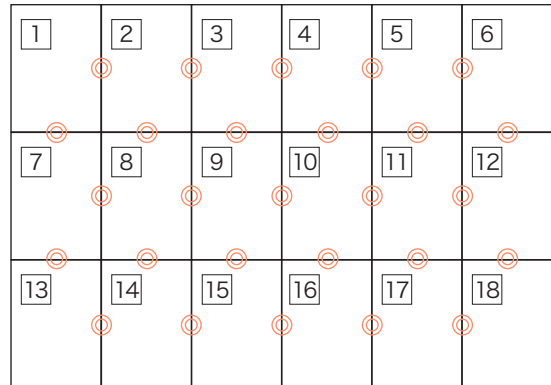

パターンは A4 サイズ 33 枚に分割されています。
印刷後、右図のようにつなぎ合わせてください。

! 印刷時の注意

印刷設定では、「ページの拡大や縮小」を選択せず
必ず、「実際のサイズ」(原寸) で印刷してください。



how to make パターンのつくりかた

STEP1 斜線部分  は切り取り、灰色部分  は残してのりしろにします。
(斜線と灰色を間違えないように注意)

STEP2 各用紙の番号を確認し、 の位置を合わせて、のりつけします。
(水のりは用紙が波打ちます。スティック糊などをお使いください)

STEP3 それぞれのパーツをハサミで切り出します。

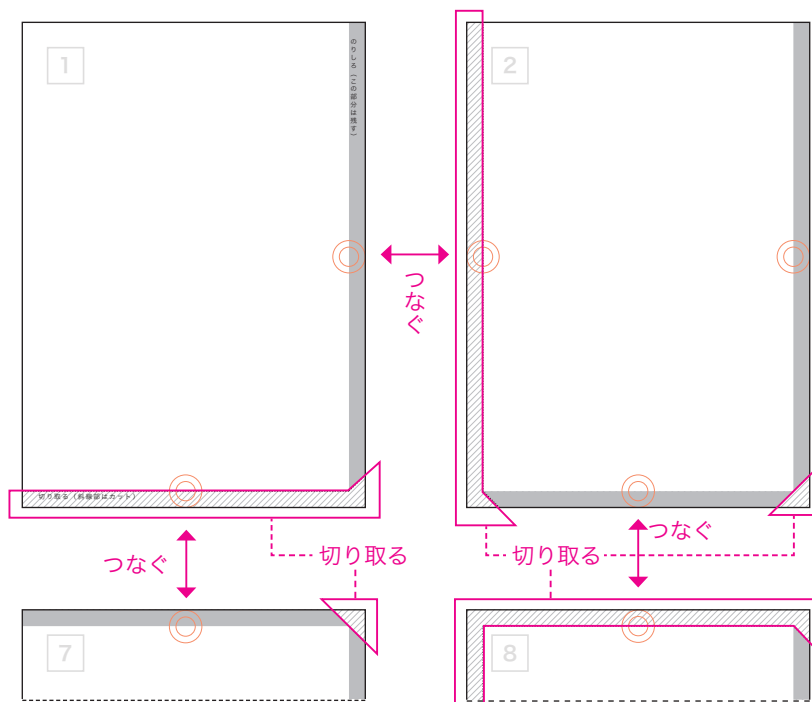
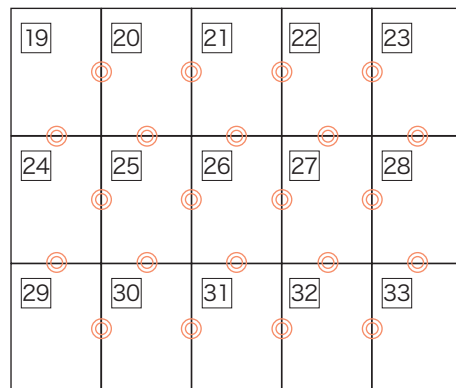

1

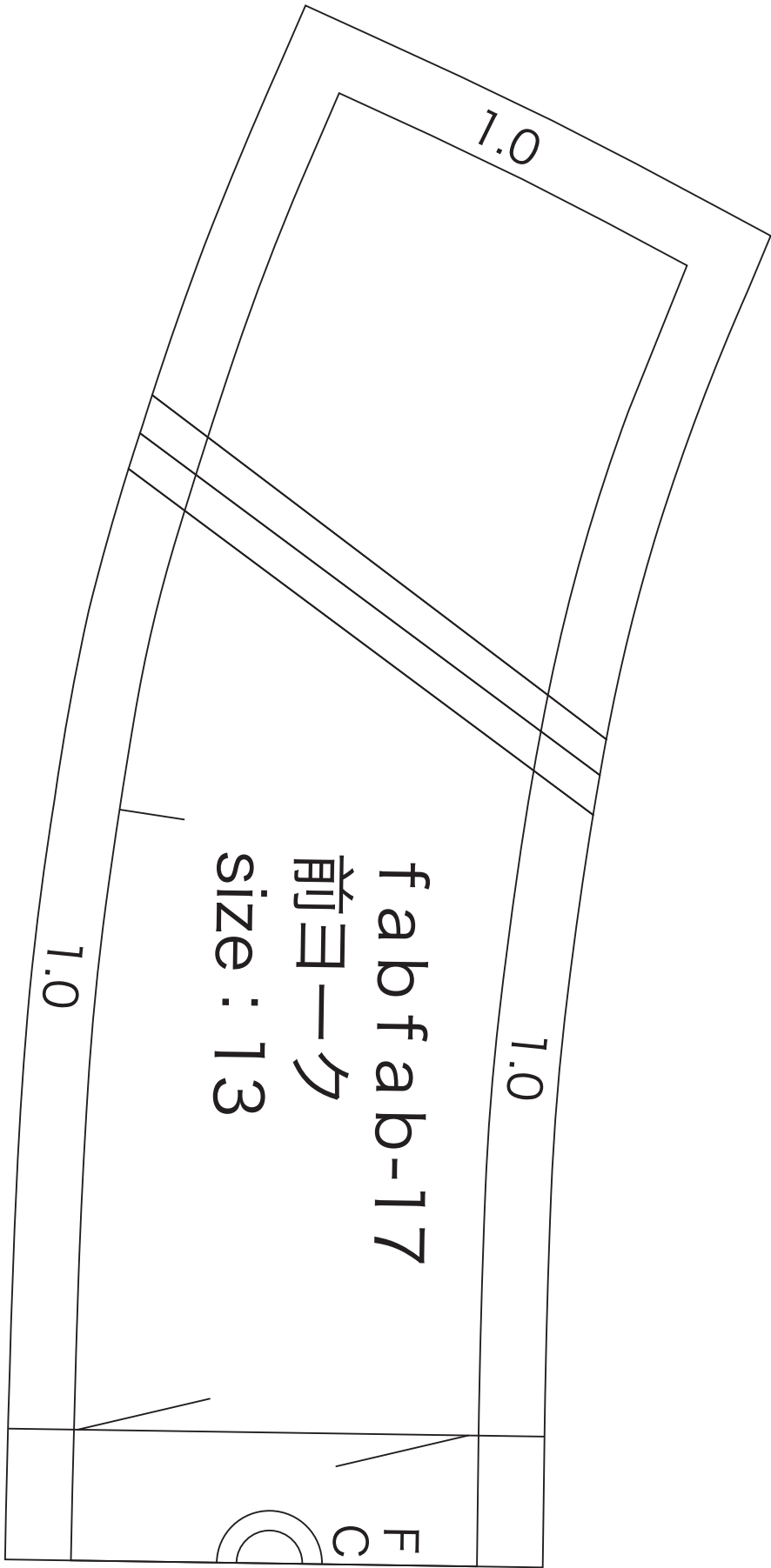

2

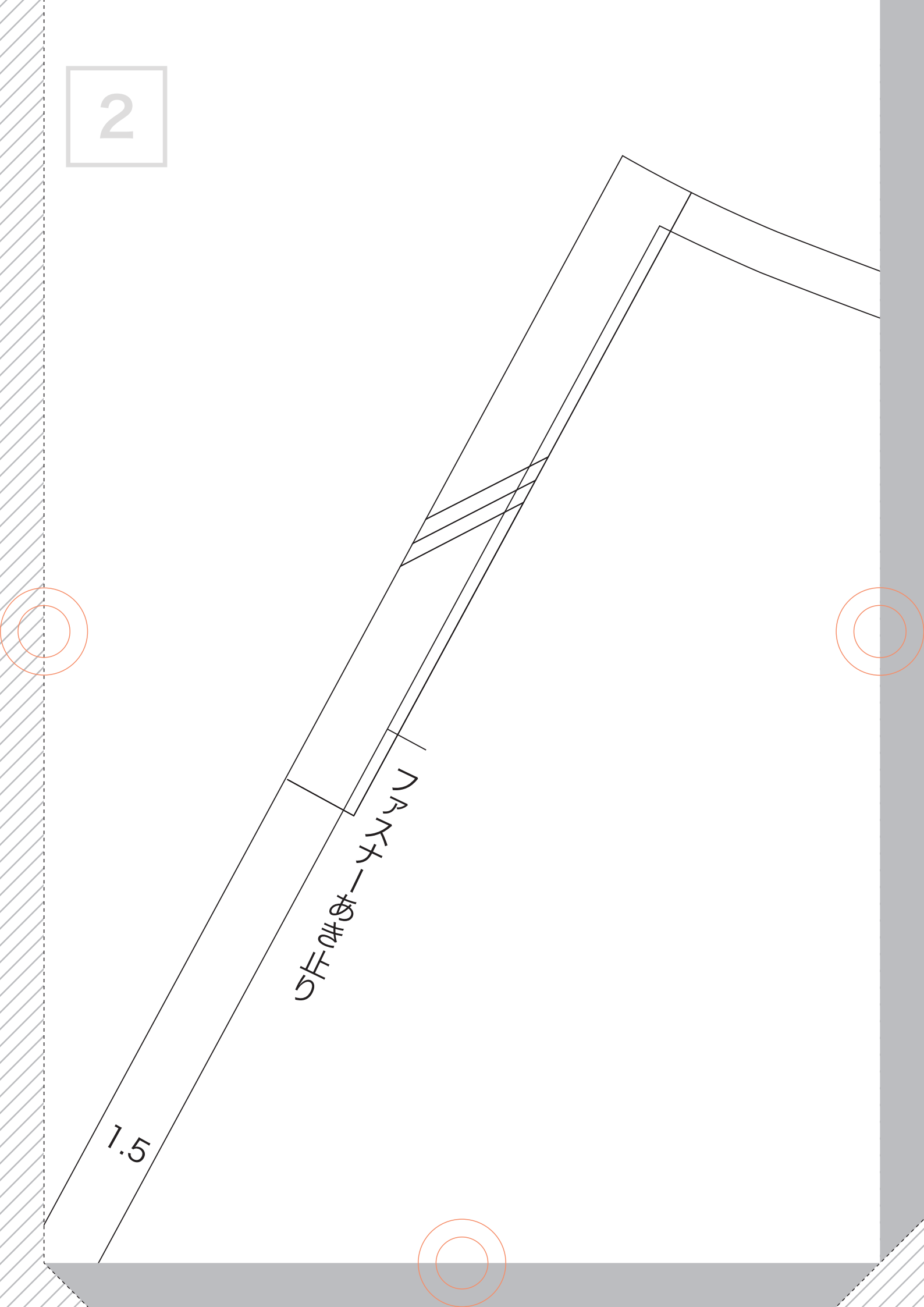

1.5

5F048-422U

3

1.0

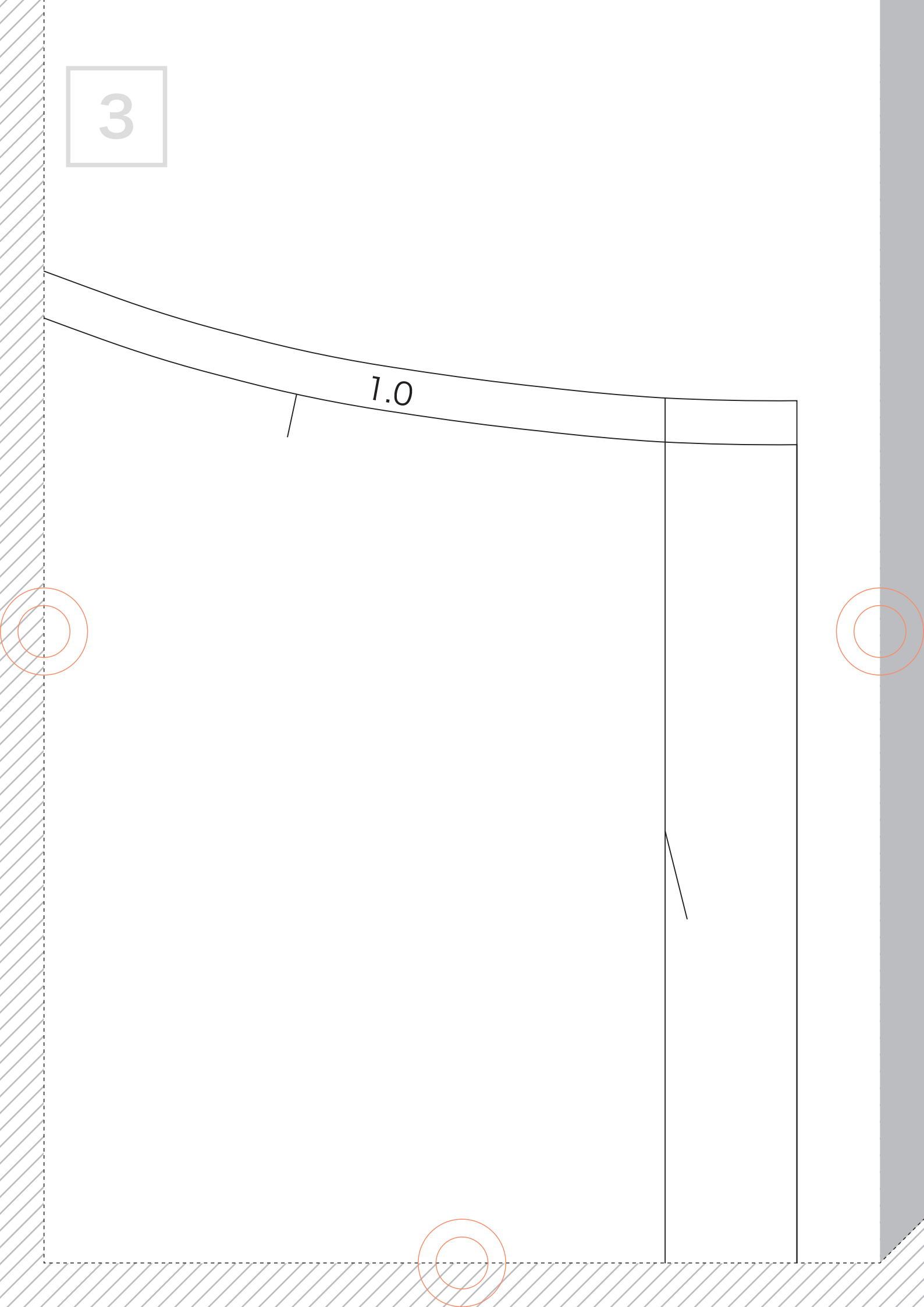
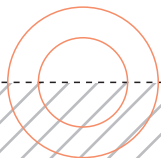
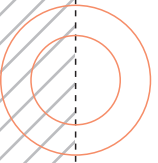

4

1.0

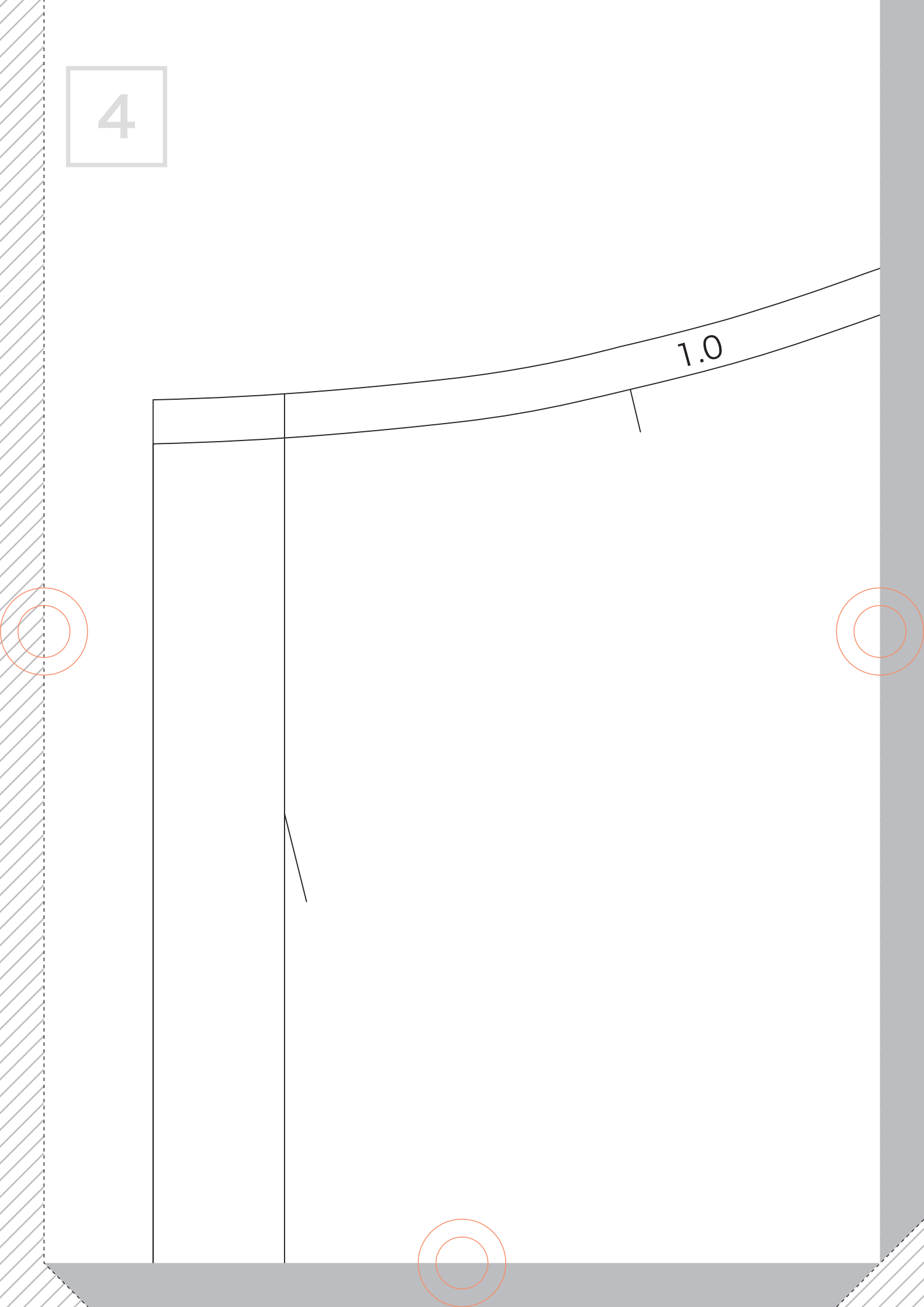
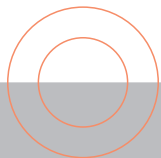
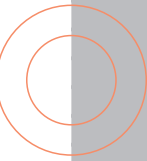
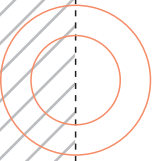

5

CFR-1000

1.5

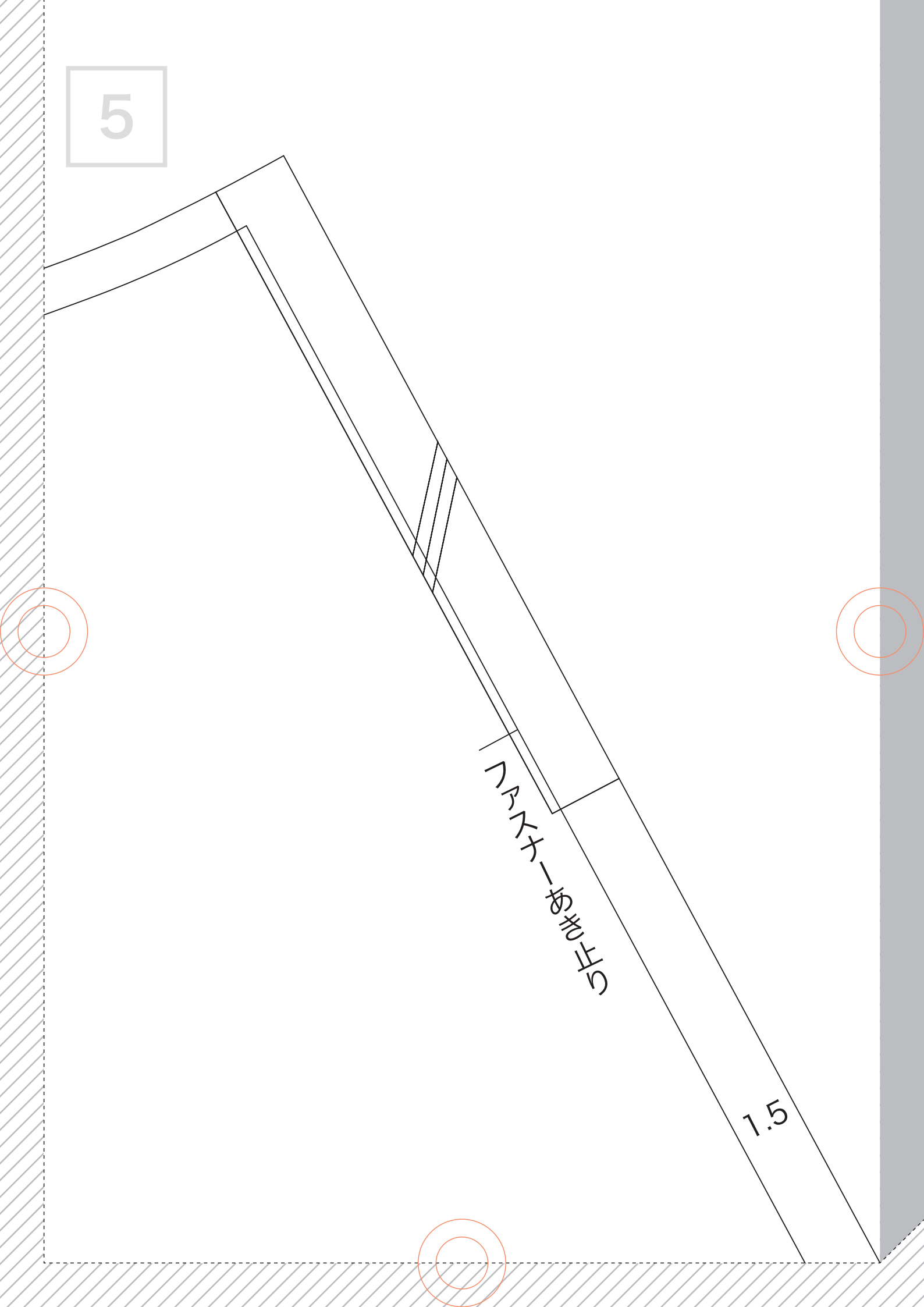
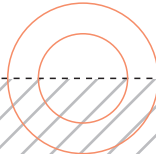
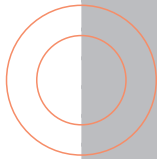
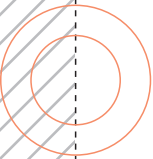

6

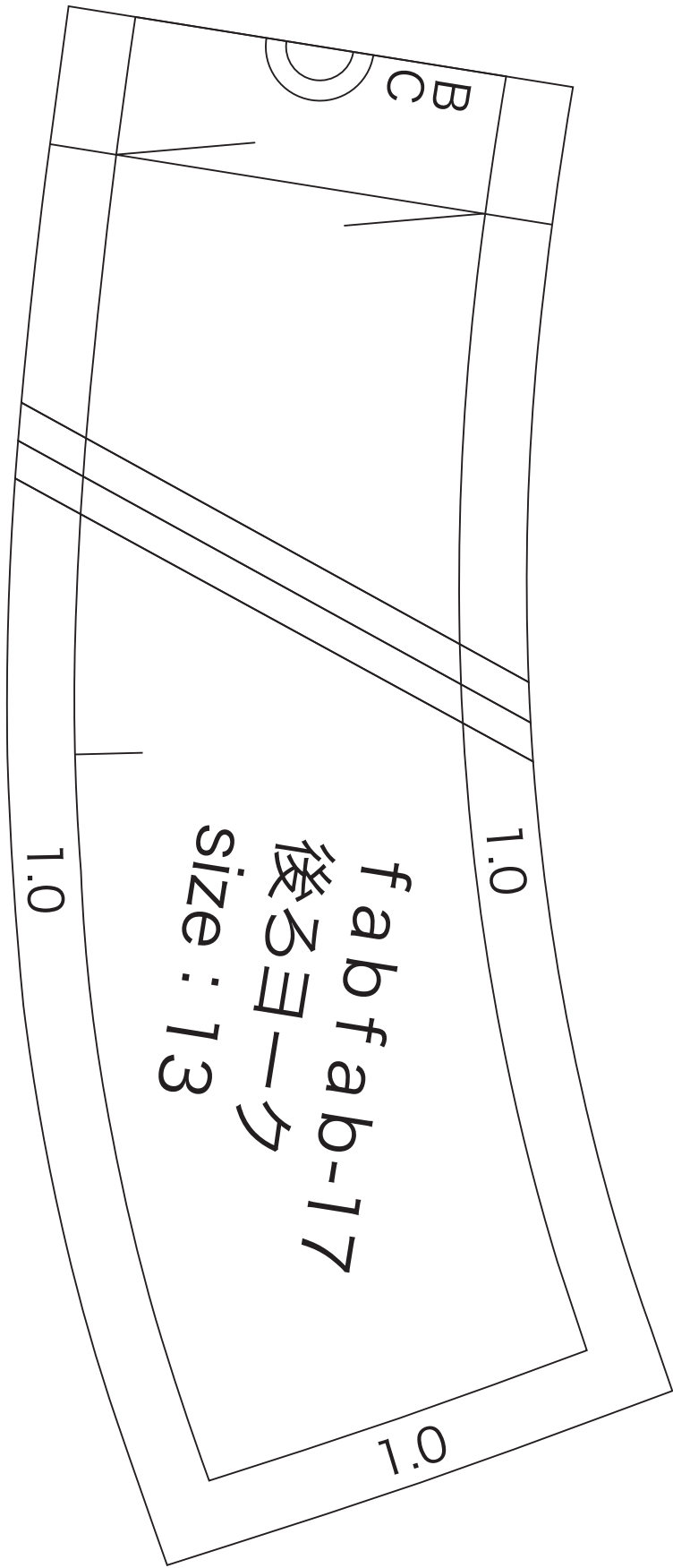

7

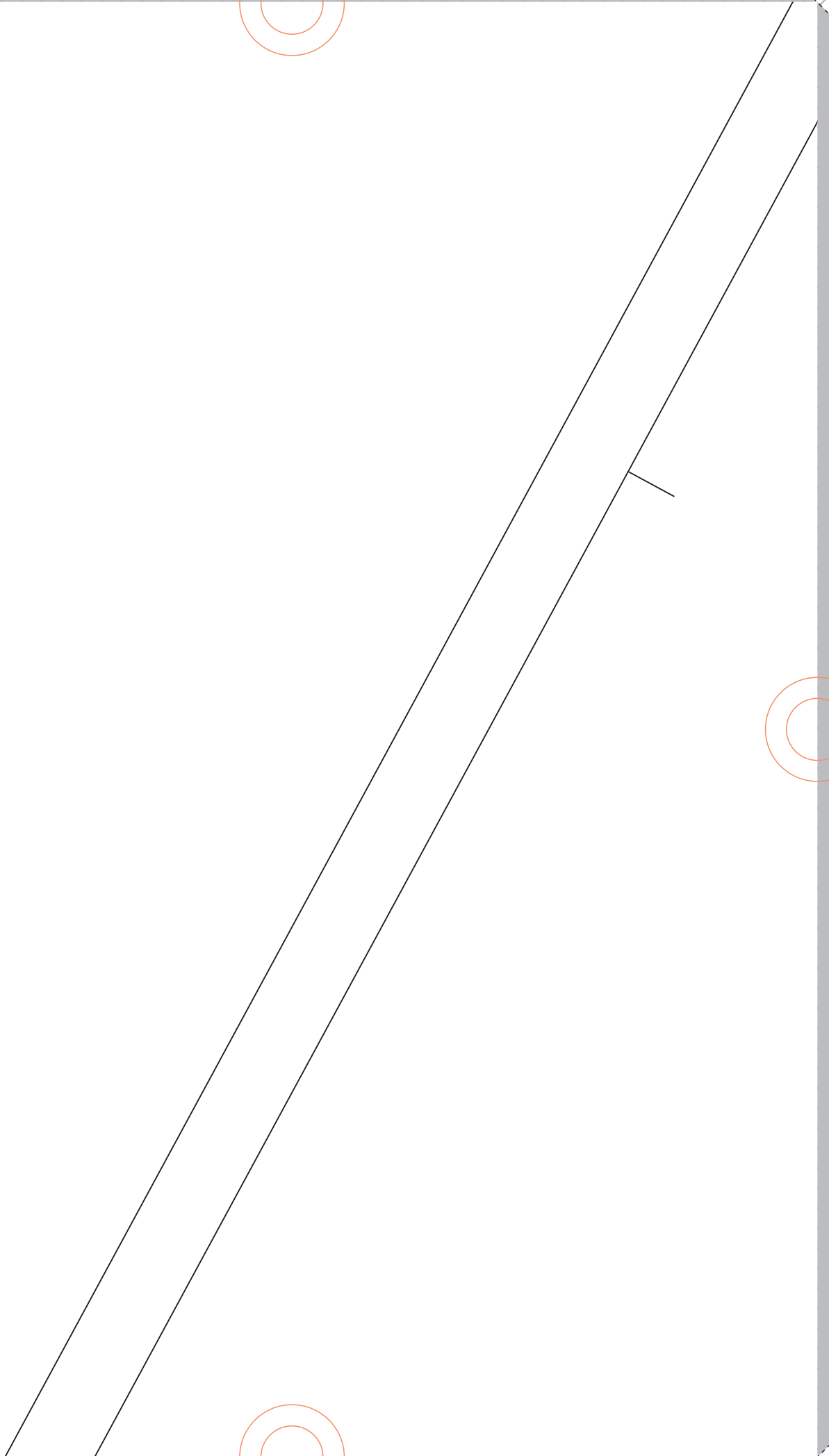
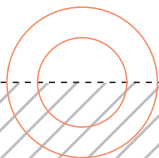
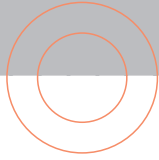

8

f a b f a b-17

前スカート

size : 13

9

С П

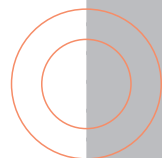
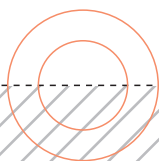
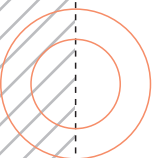

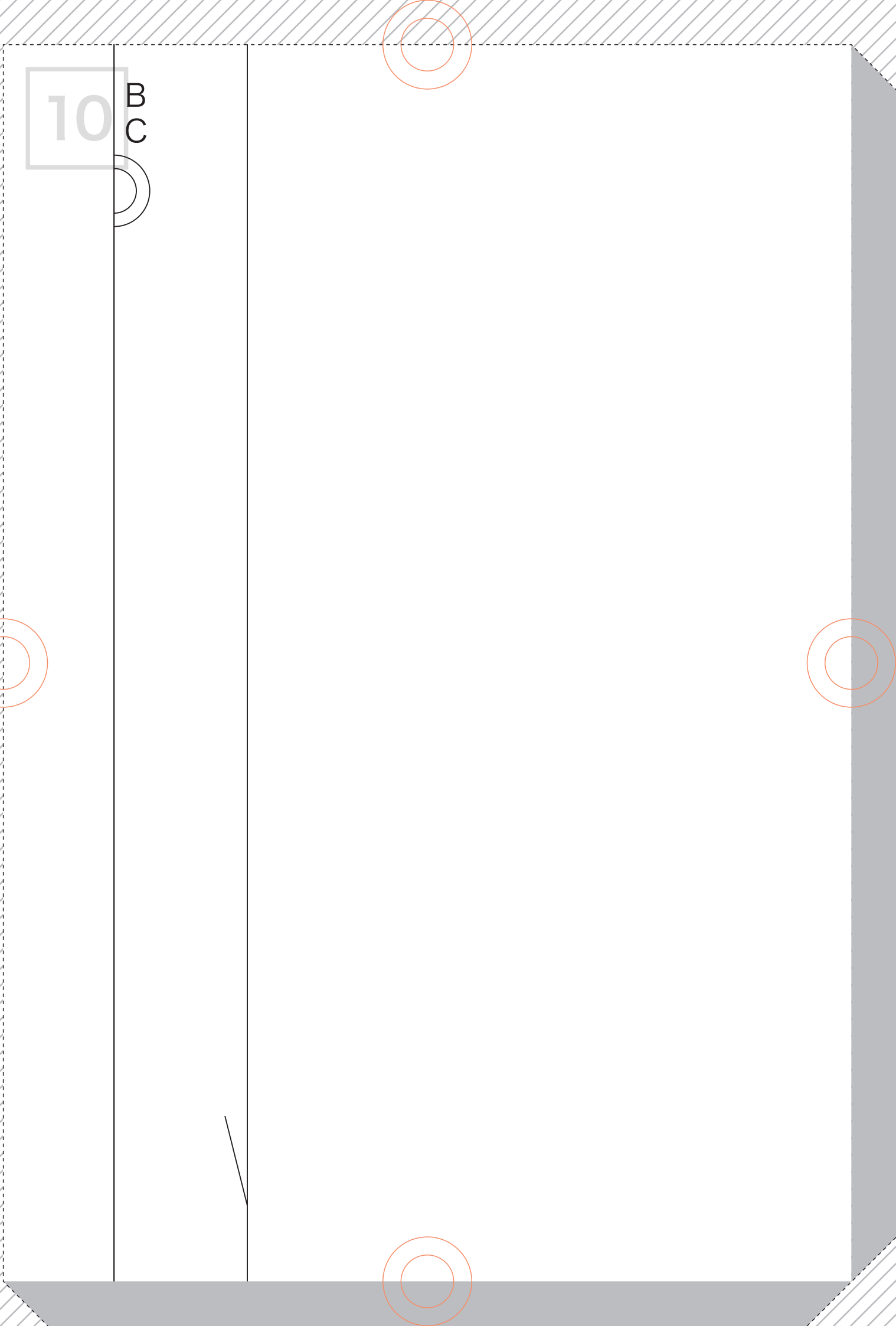

11

f a b f a b - 17

後ろスカート

size : 13

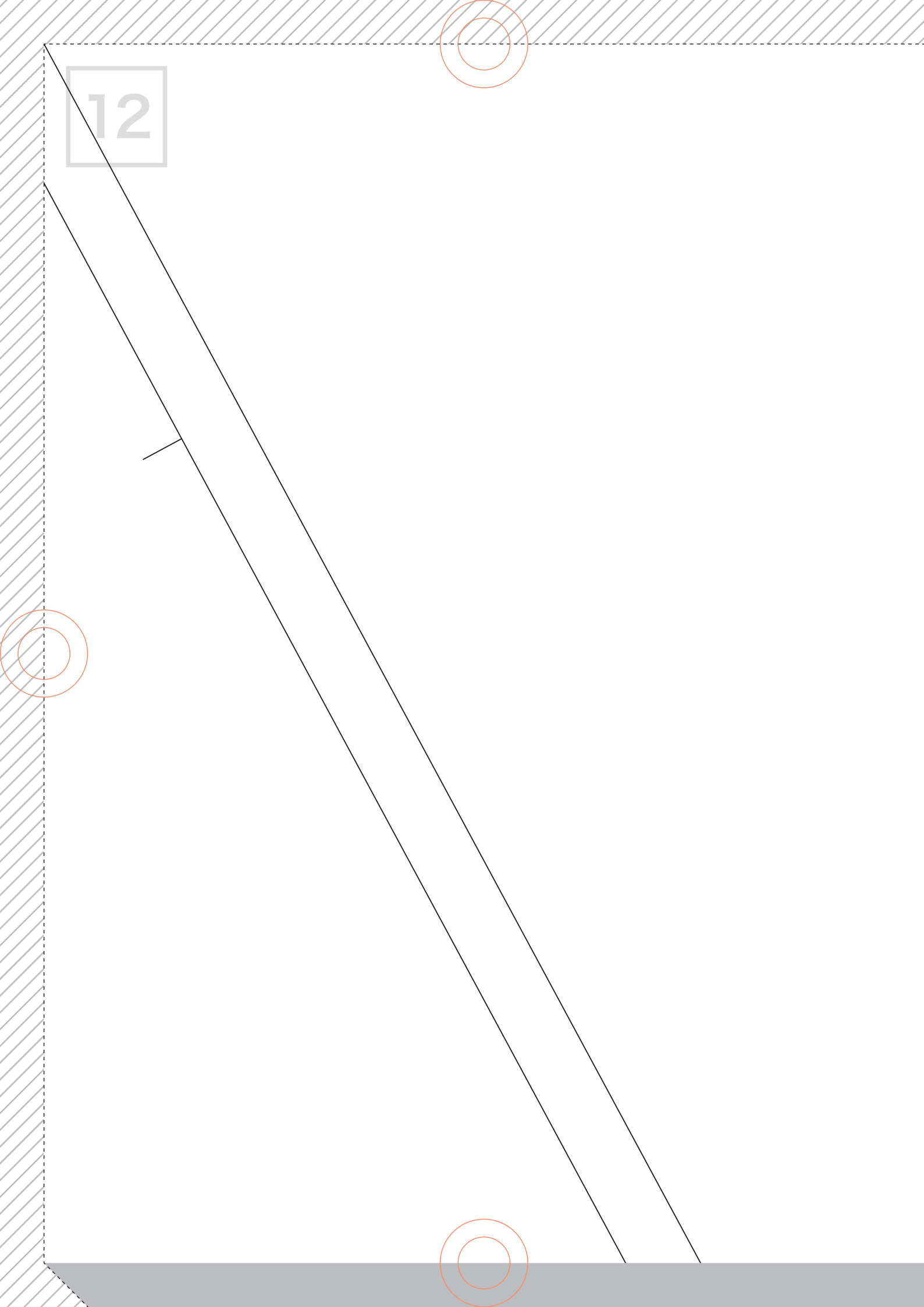

12

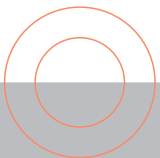
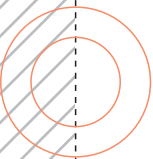
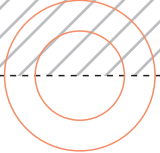

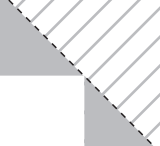

13

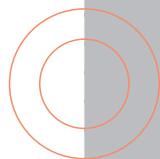
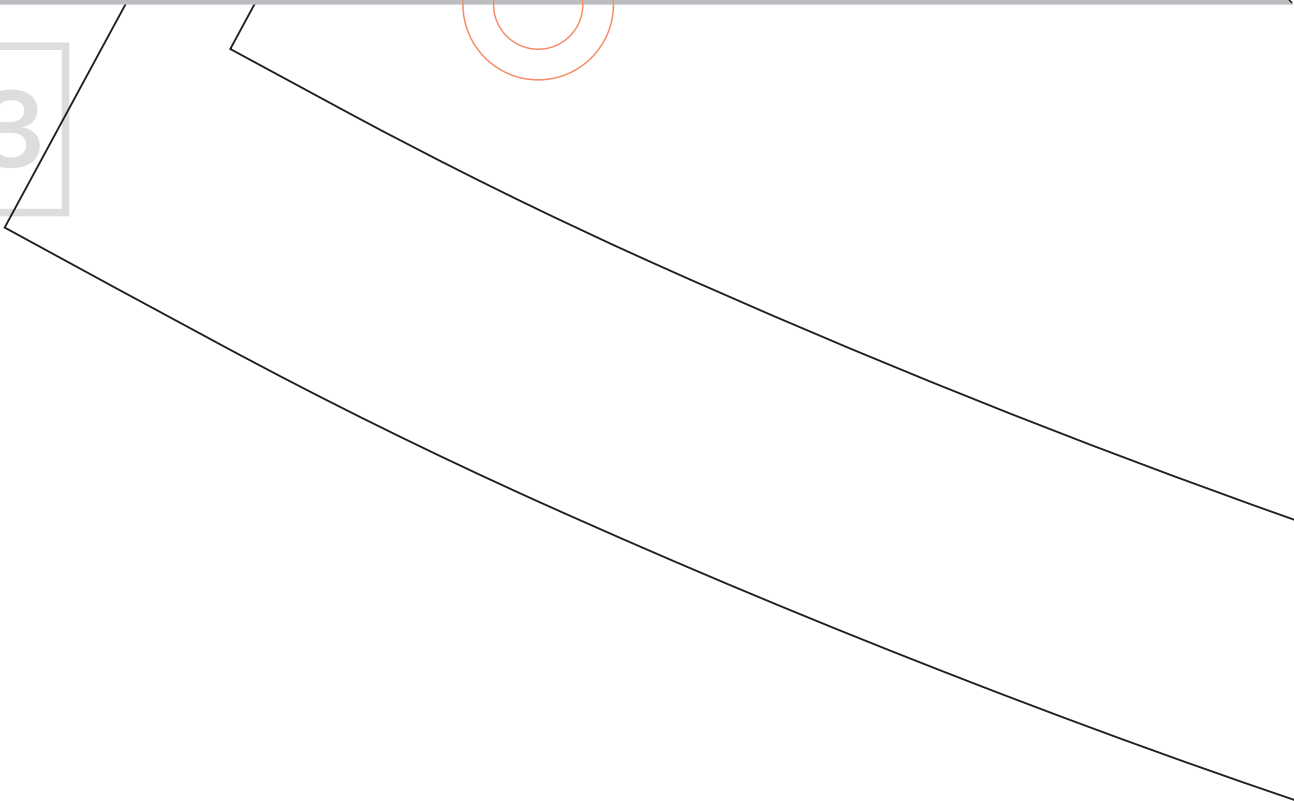

14

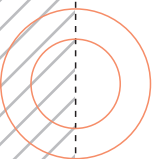
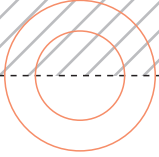

3.5

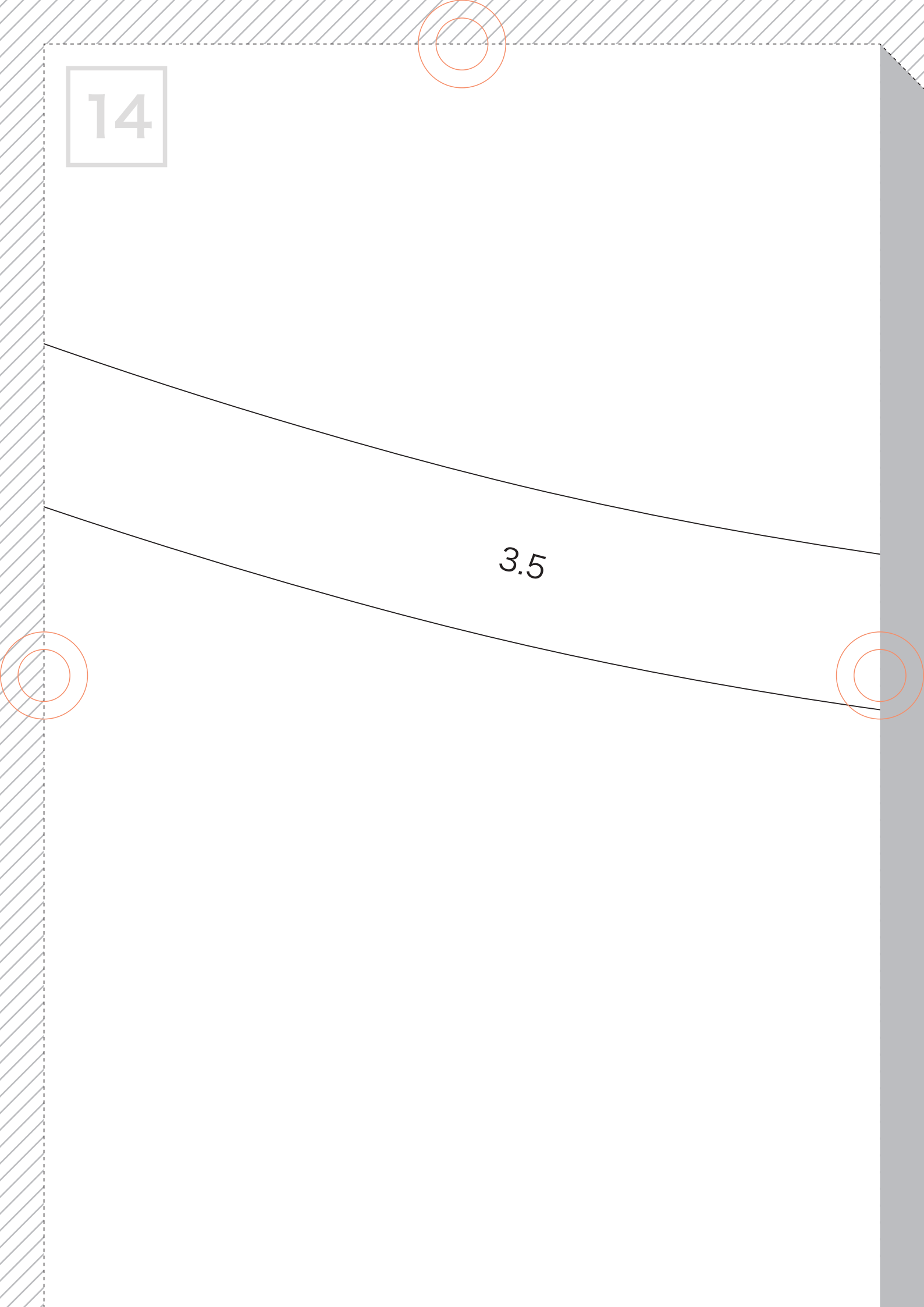

15

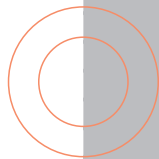
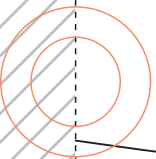
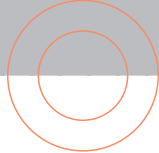

16

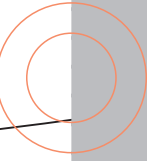
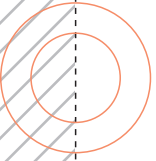
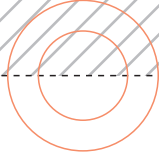

17

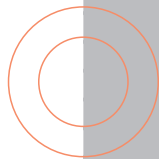
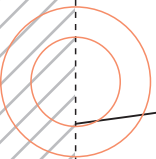
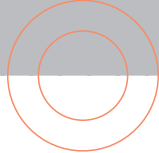

3.5

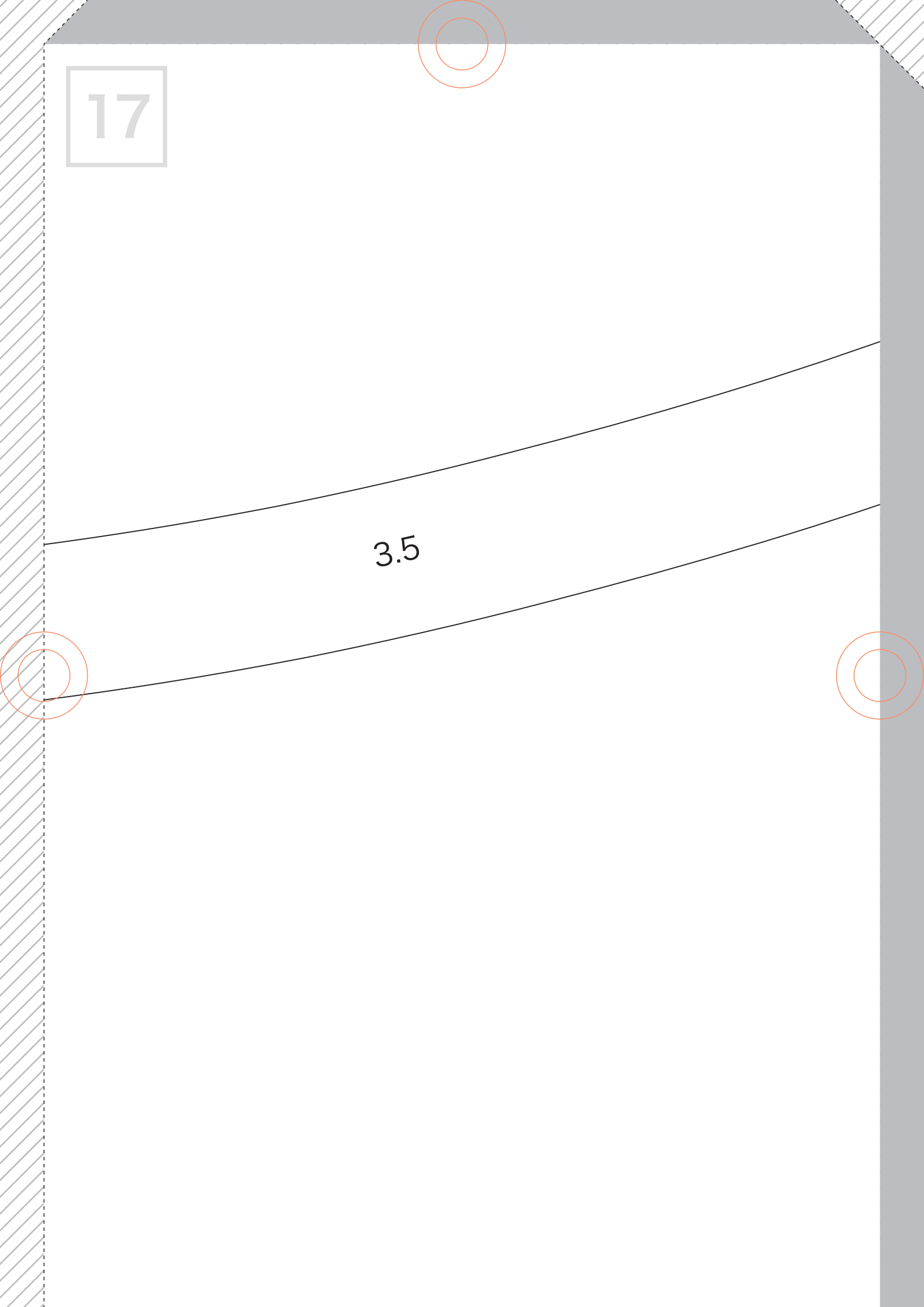

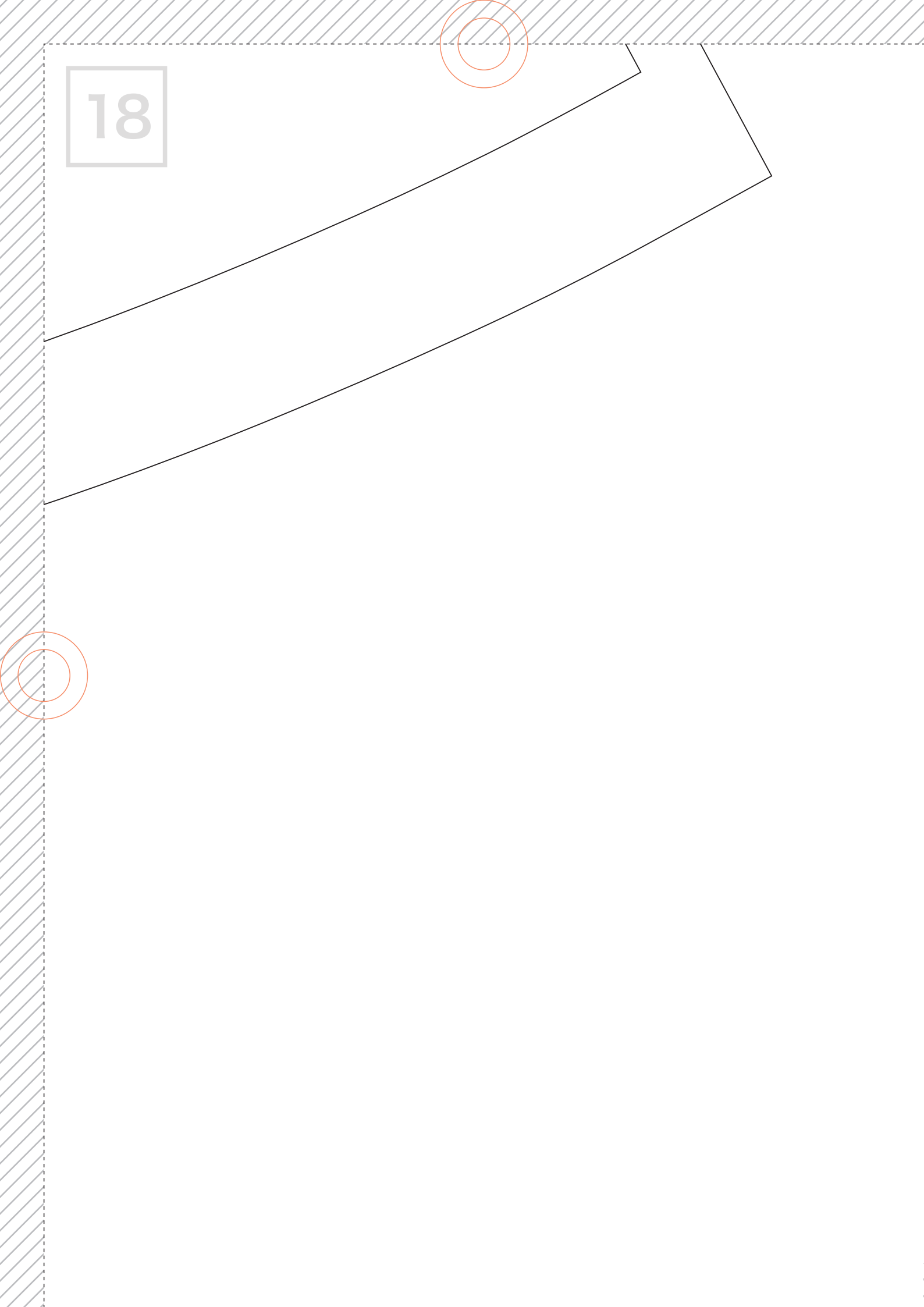

18

19

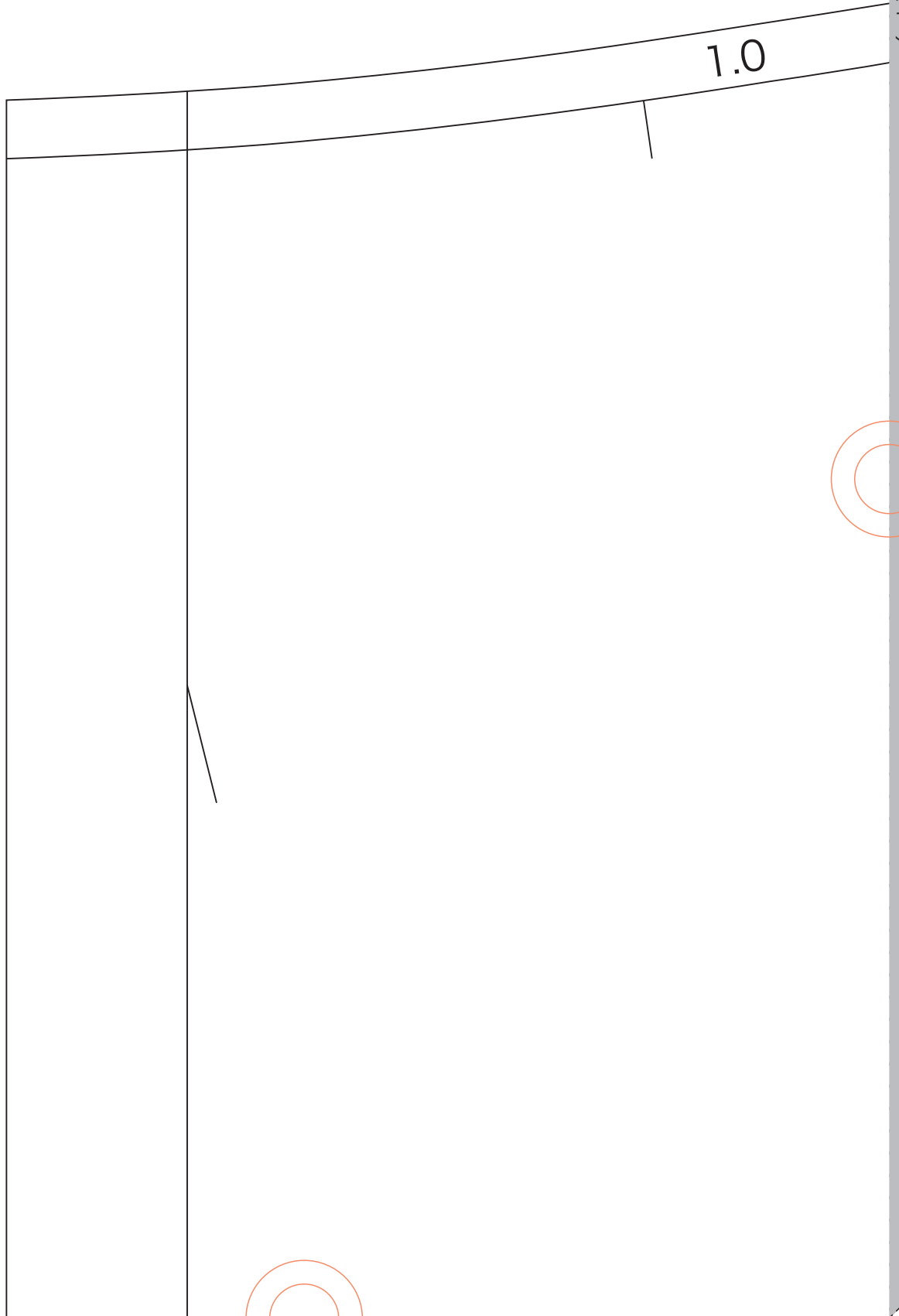

切り取る (斜線部はカット)

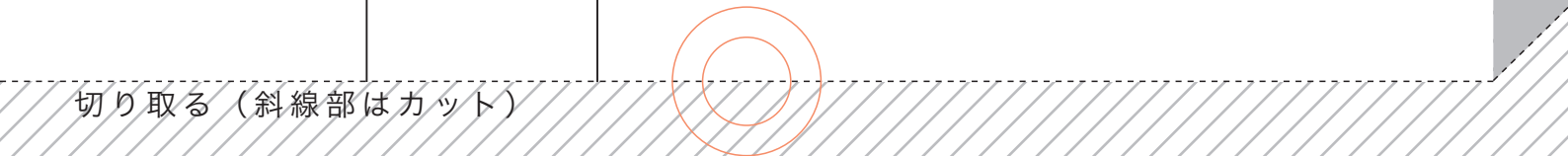

20

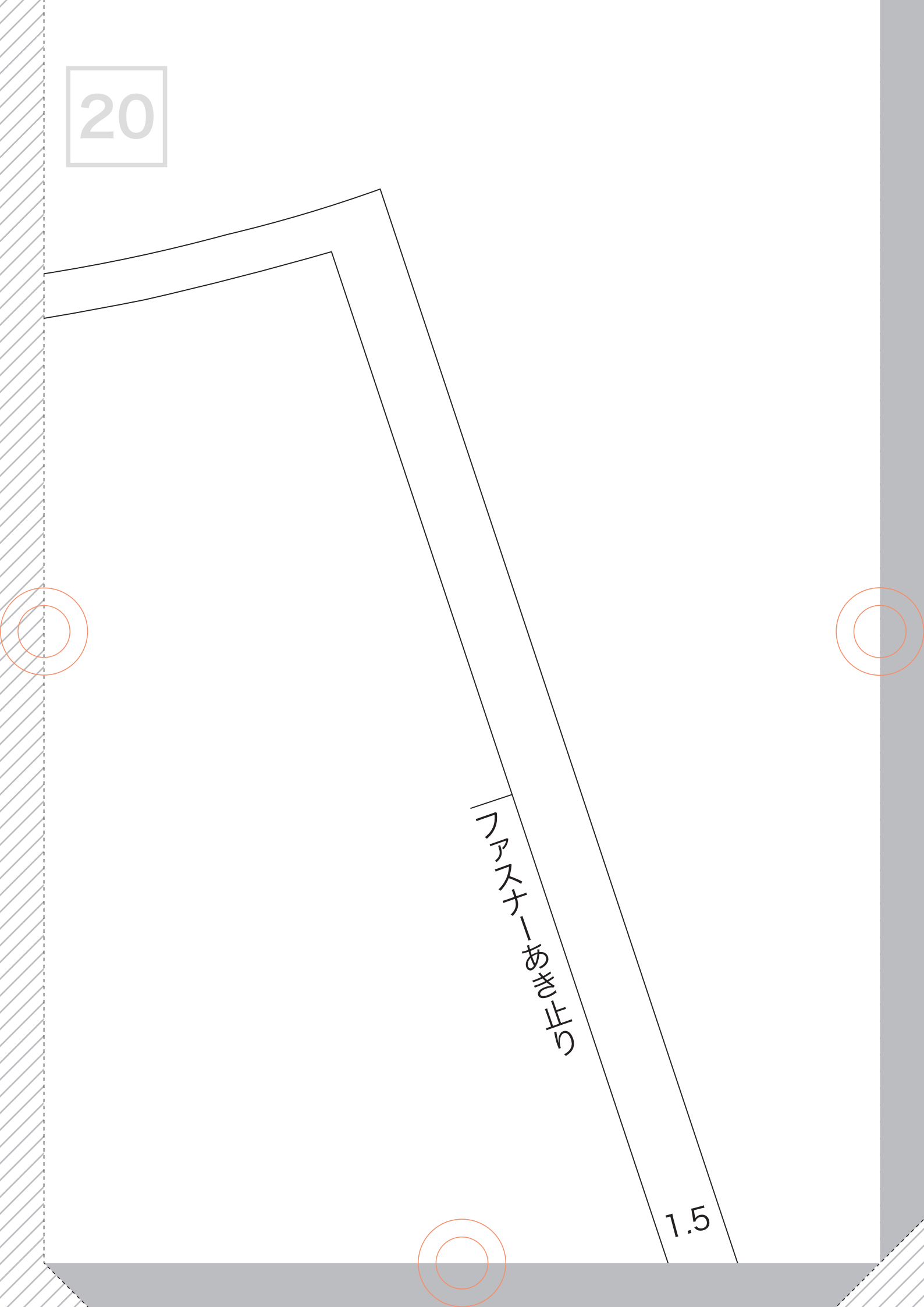

ファスナーおかし

1.5

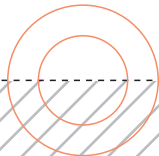
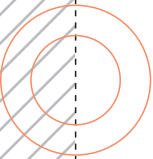

22

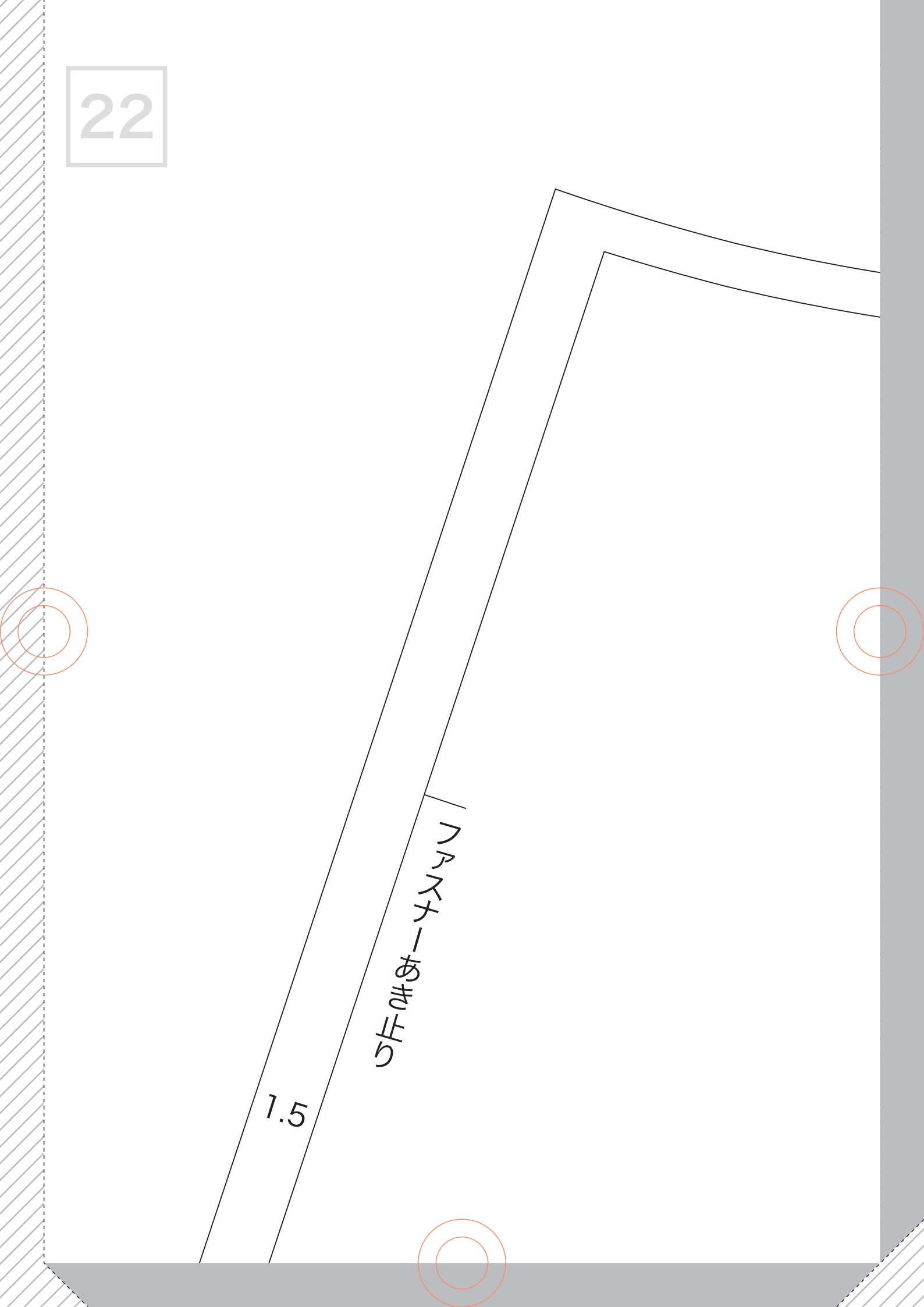

1.5

ПРЯМЫЙ
УГОЛ

23

1.0

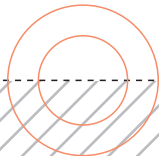
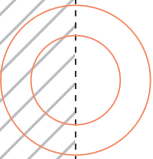

24

B
C

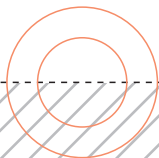
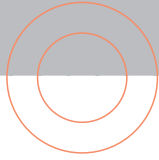

25

f a b f a b - 1 7
裏後ろスカート
size : 13

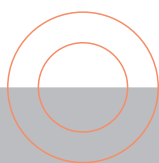
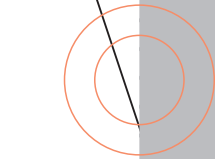
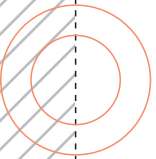
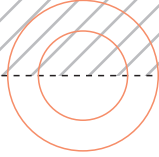

26

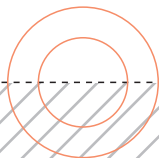
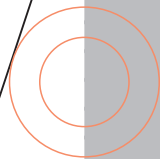
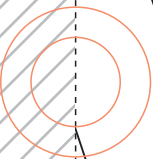
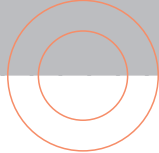

27

fabfab-17

裏前スカート

size : 13

28

С П

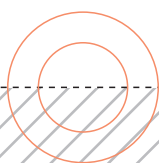
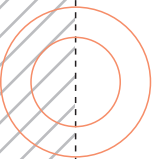
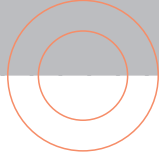

29

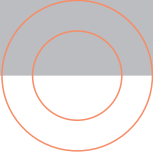

30

2.5

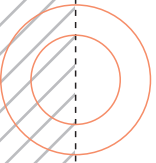
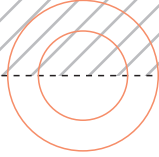

31

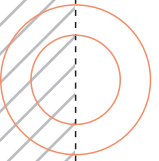
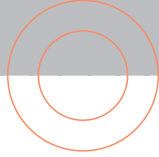

32

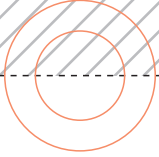

2.5

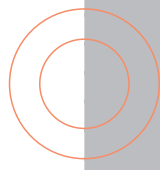
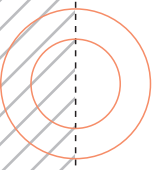

33

