

introduction はじめに

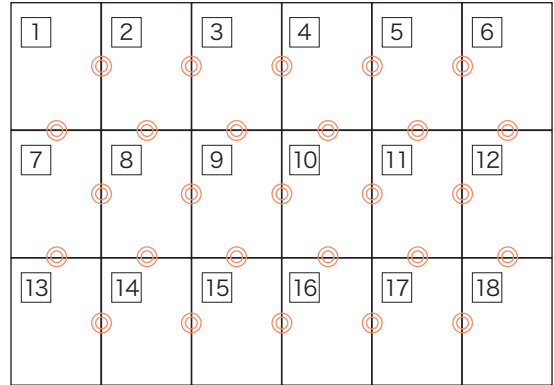

パターンは A4 サイズ 33 枚に分割されています。
印刷後、右図のようにつなぎ合わせてください。

! 印刷時の注意

印刷設定では、「ページの拡大や縮小」を選択せず
必ず、「実際のサイズ」(原寸) で印刷してください。



how to make パターンのつくりかた

STEP1 斜線部分  は切り取り、灰色部分  は残してのりしろにします。
(斜線と灰色を間違えないように注意)

STEP2 各用紙の番号を確認し、 の位置を合わせて、のりつけします。
(水のりは用紙が波打ちます。スティック糊などをお使いください)

STEP3 それぞれのパーツをハサミで切り出します。

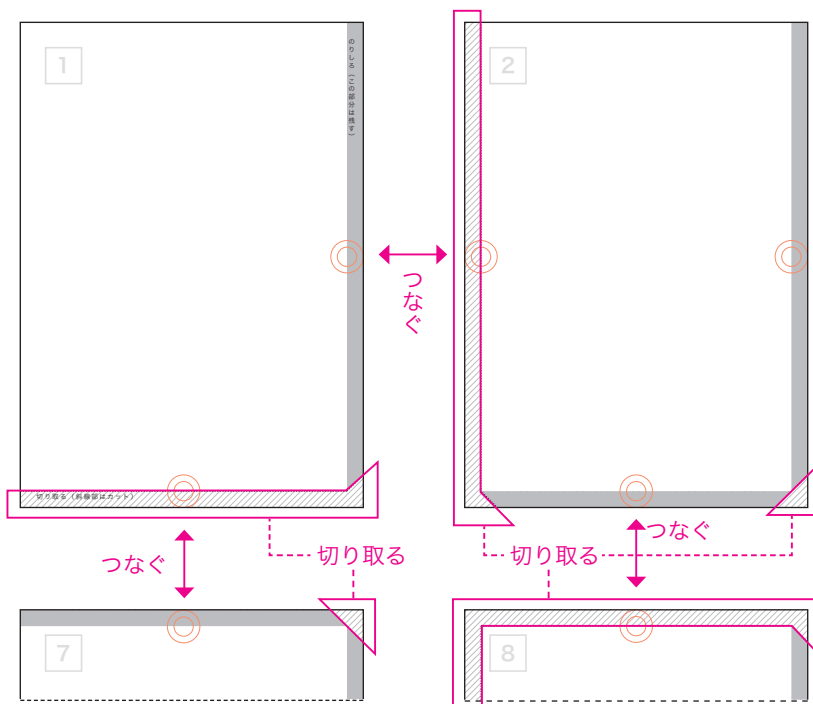
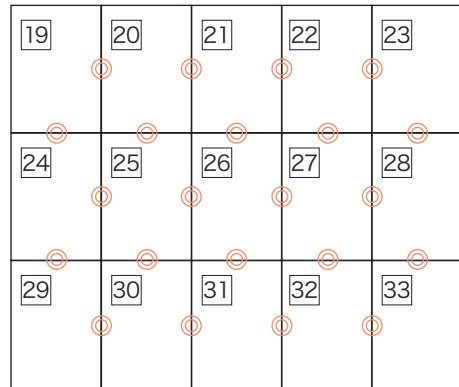



1

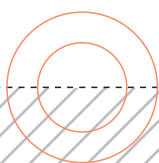
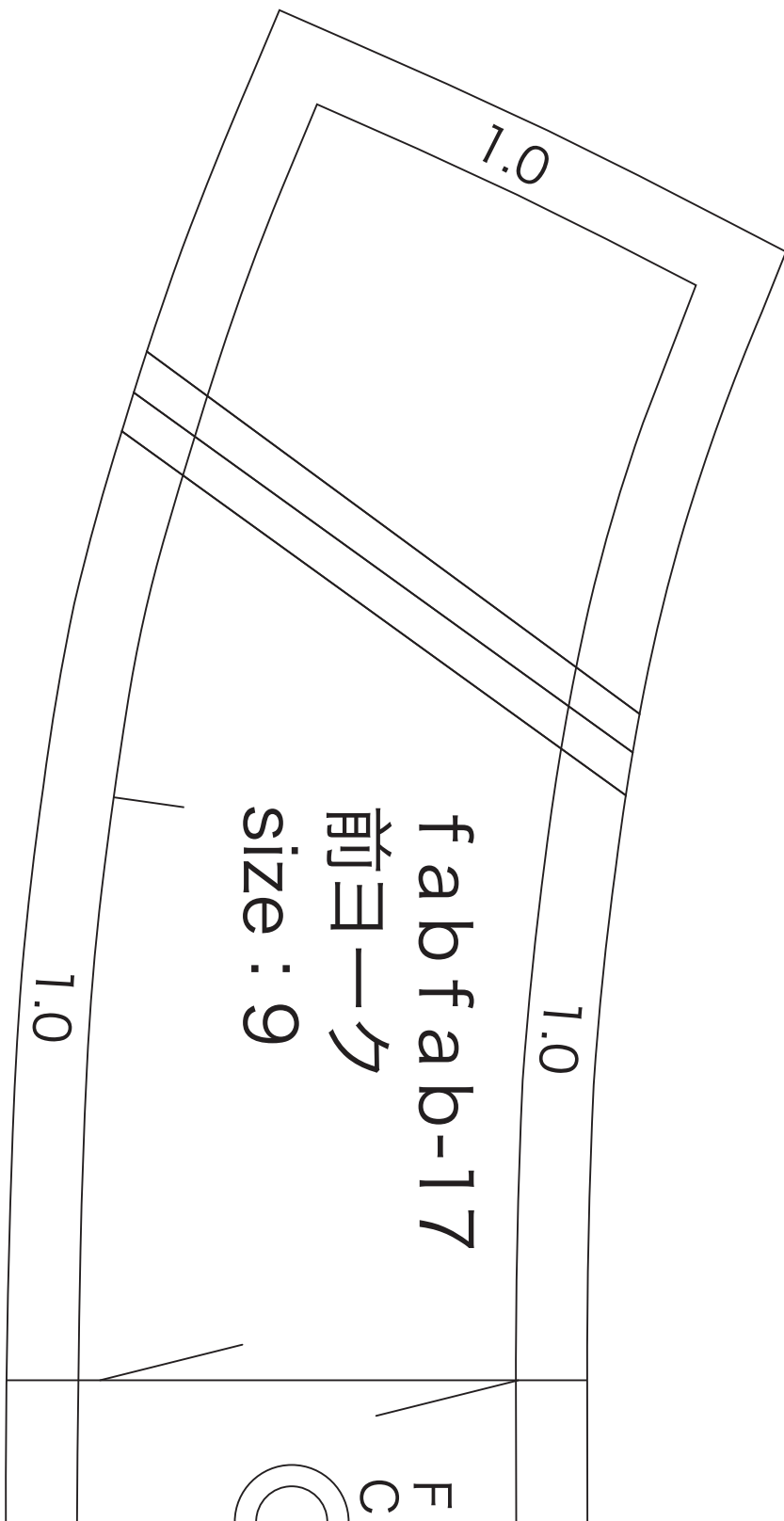

2

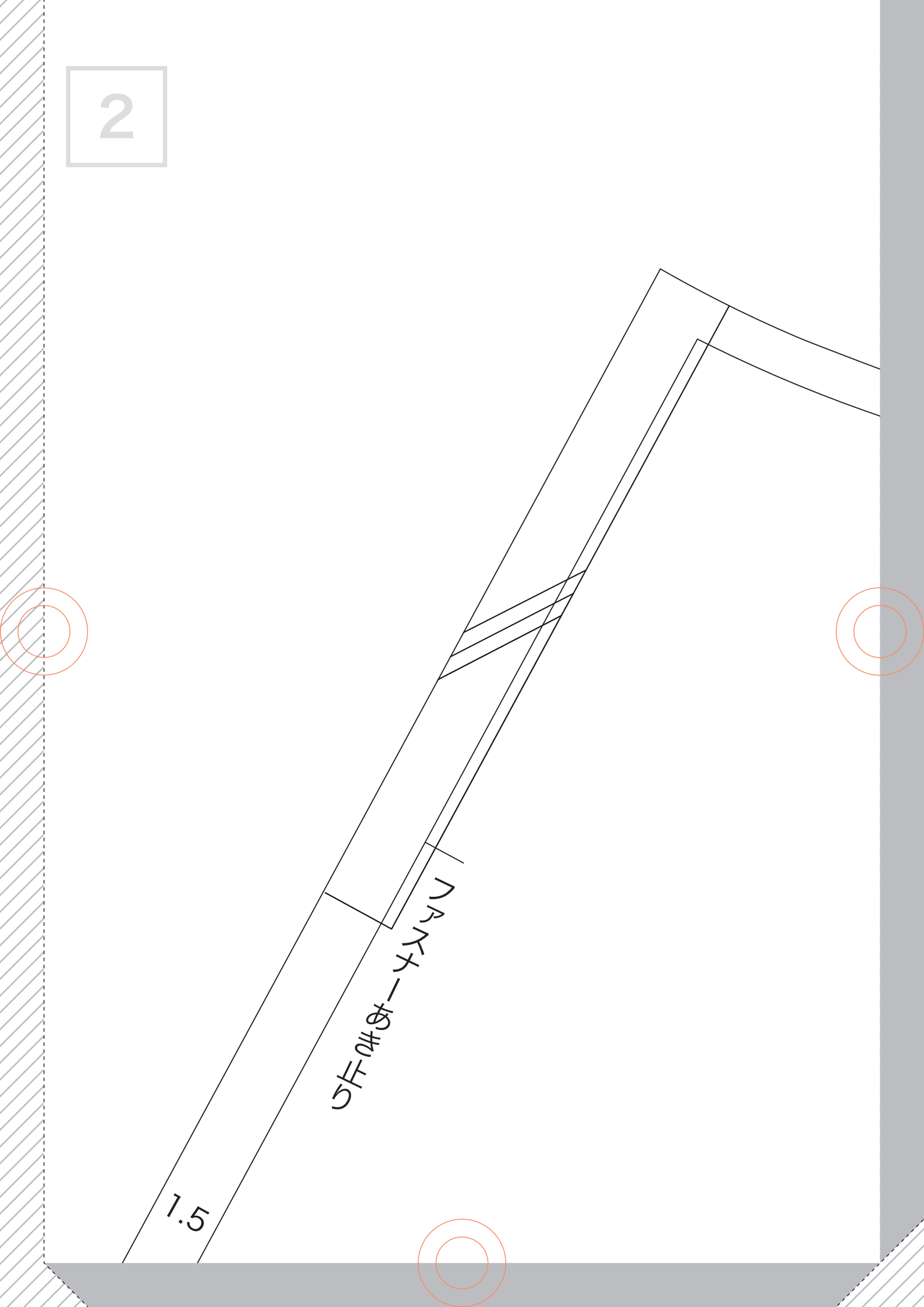

3

1.0

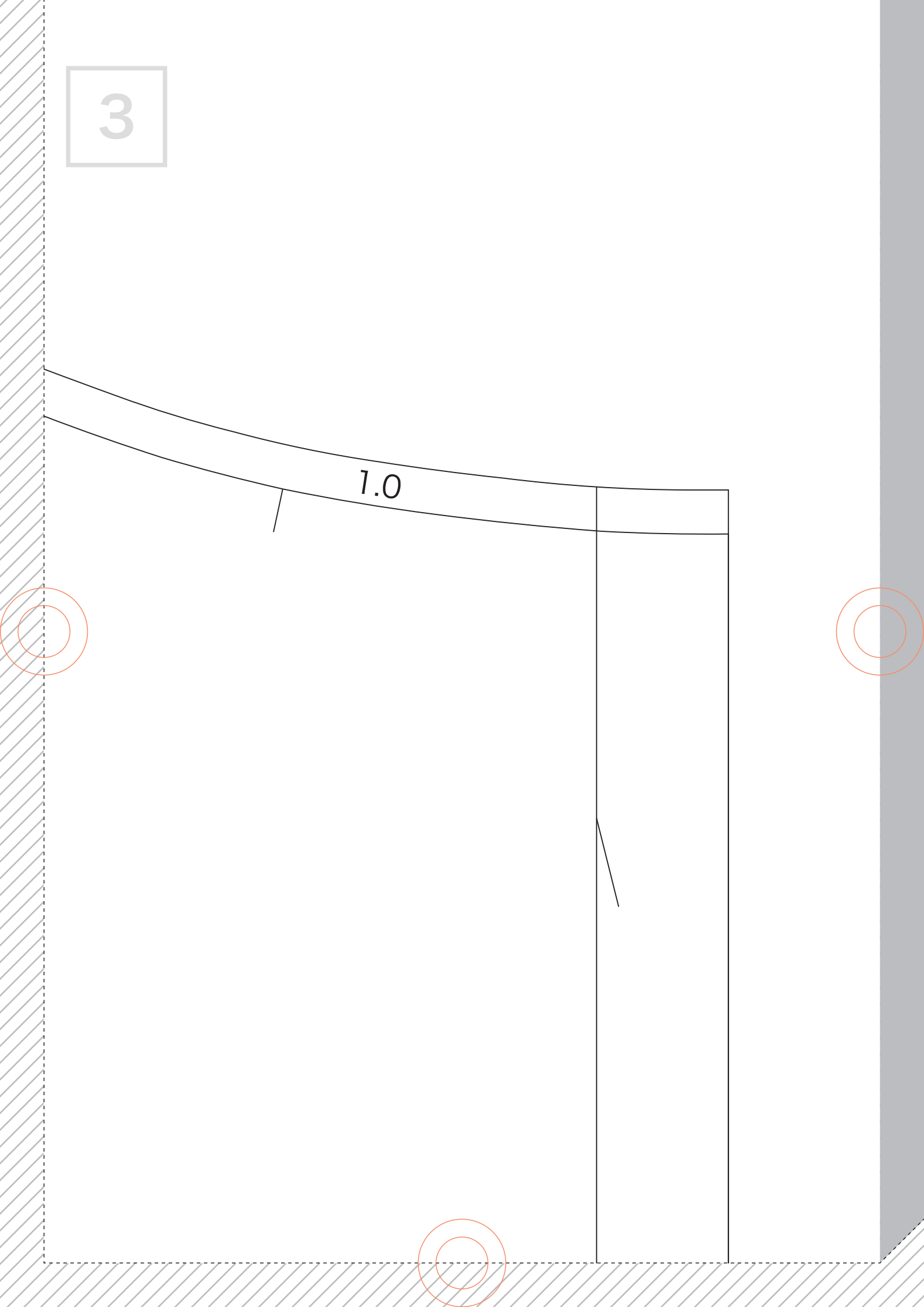
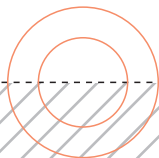
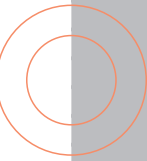
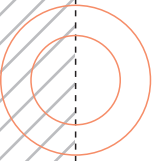

4

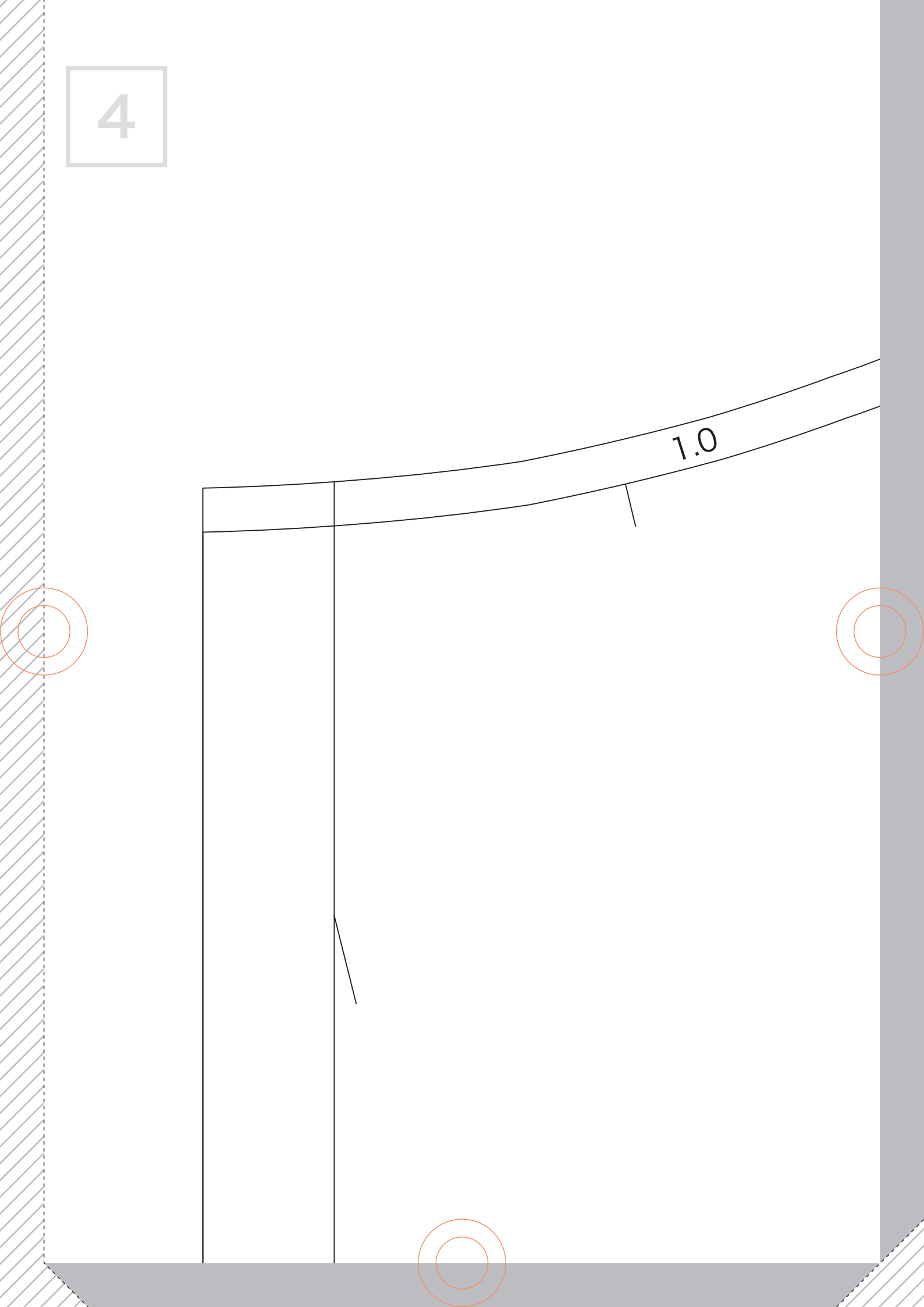

5

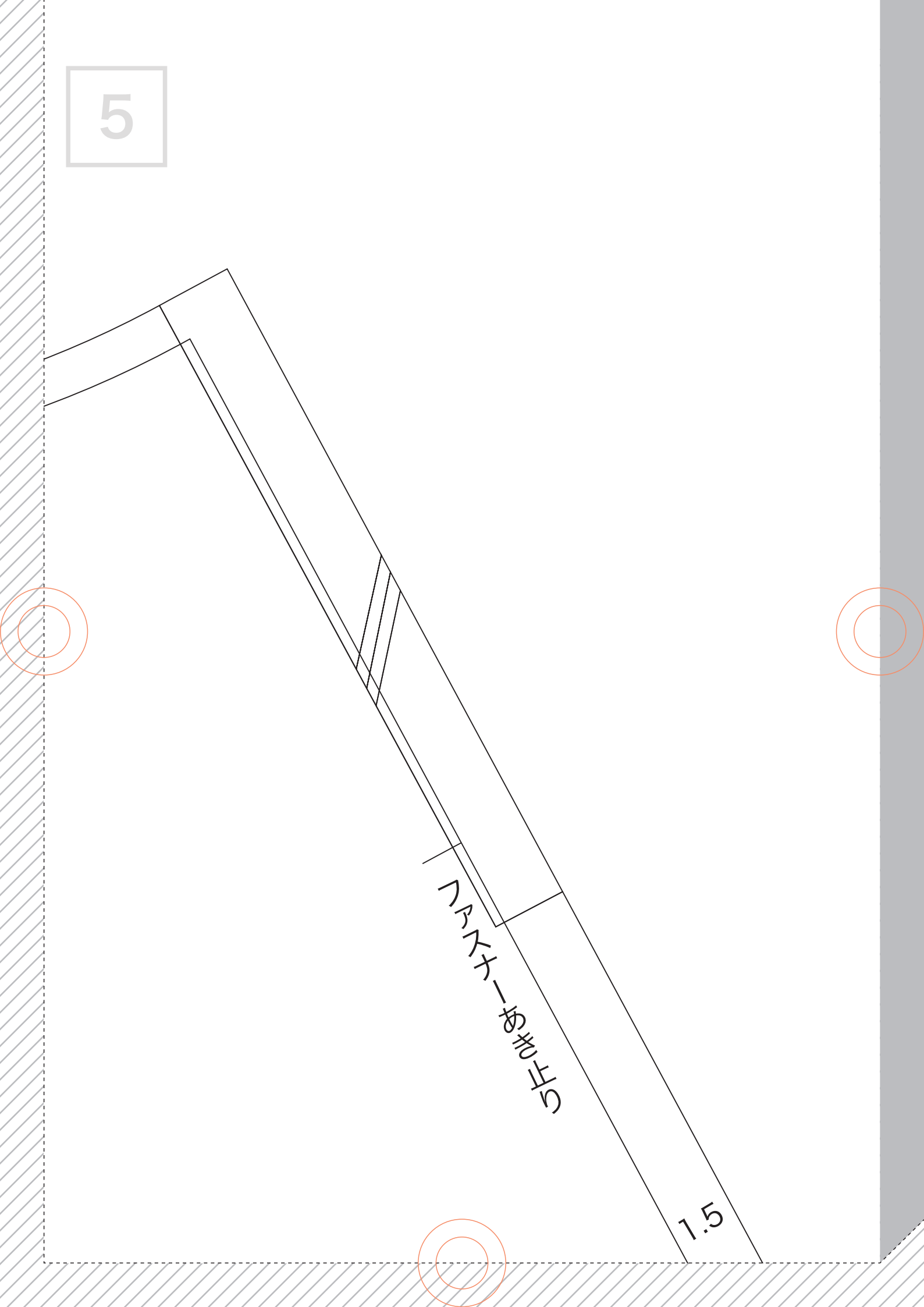

6

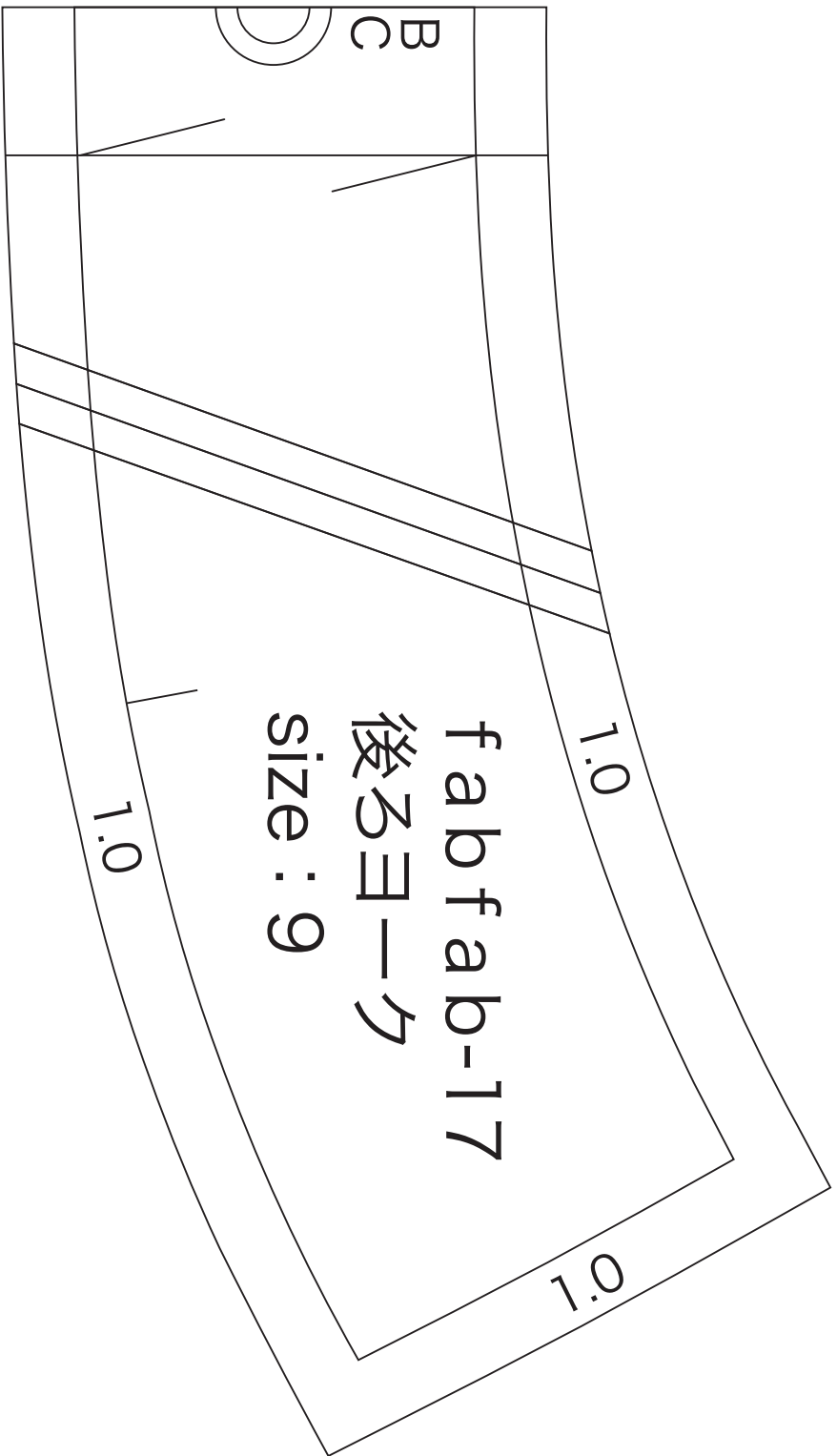

7

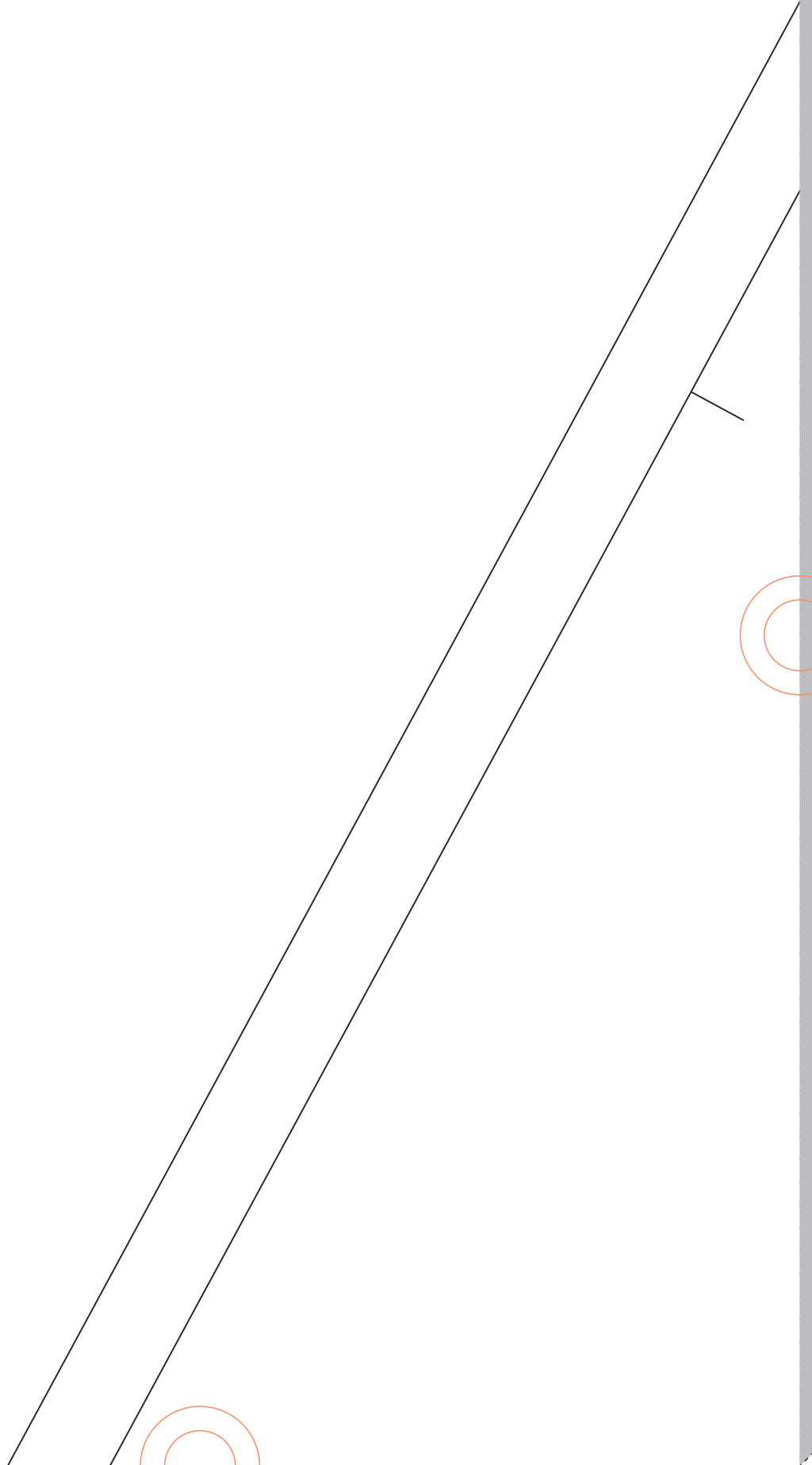
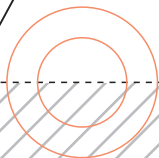
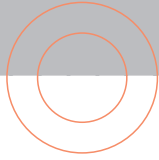



8

f a b f a b - 1 7

前スカート

size : 9

9

CT

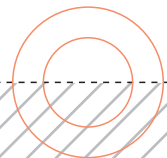
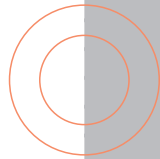
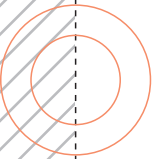
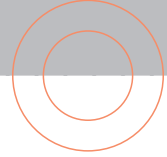

10

C B

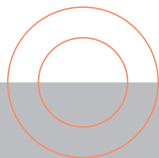
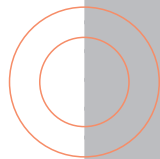
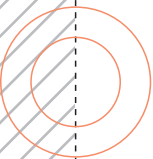
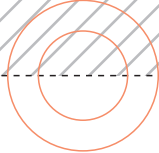

11

f a b f a b - 1 7

後ろスカート

size : 9

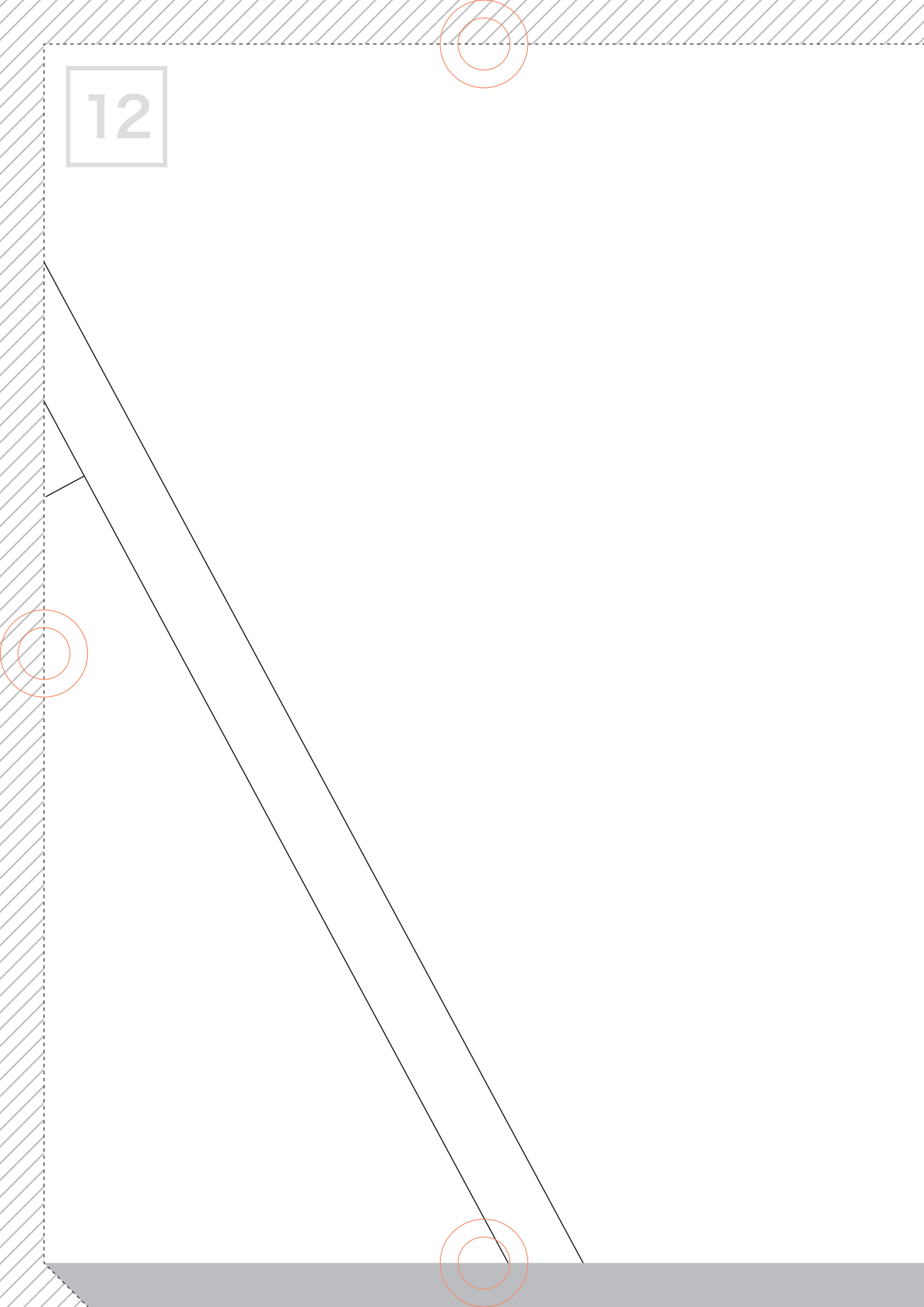

12

13

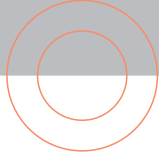
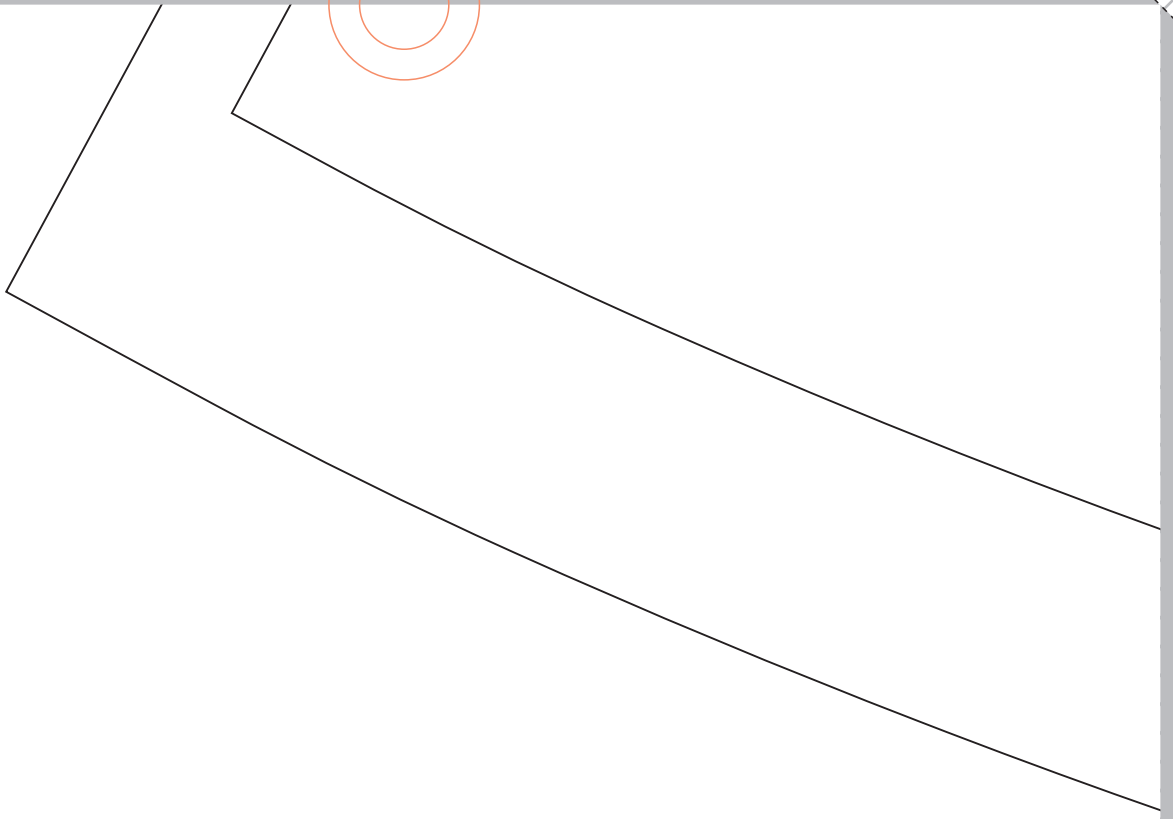

14

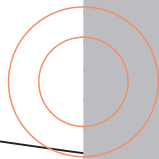
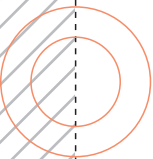
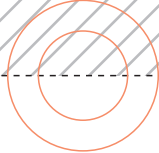

3.5

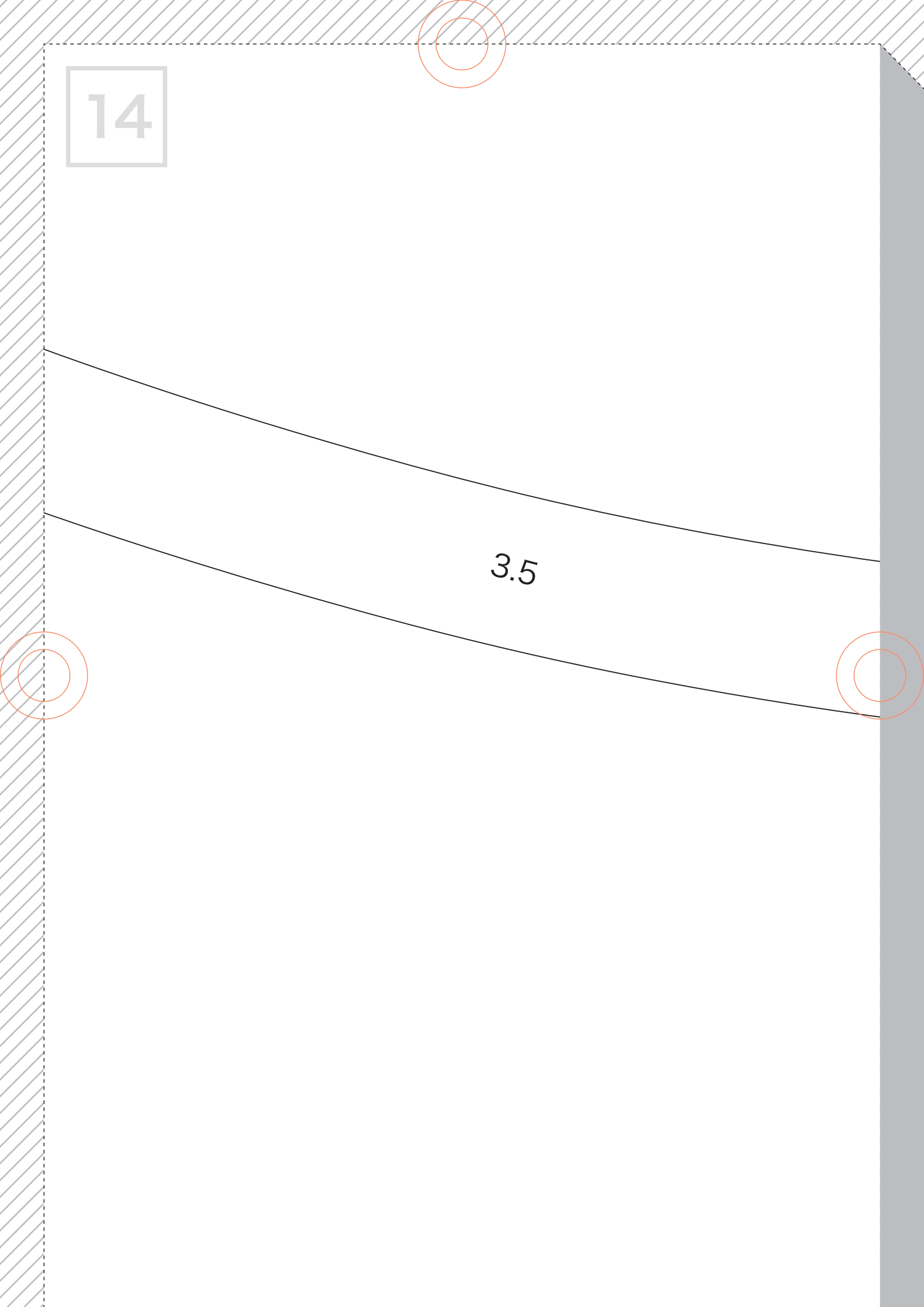

15

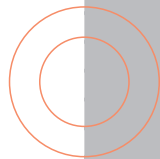
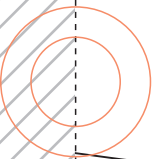
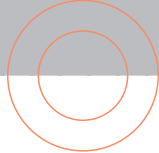

16

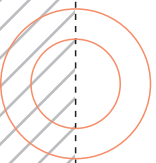
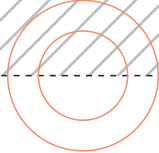

17

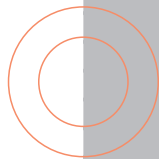
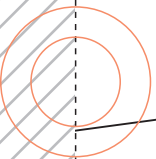
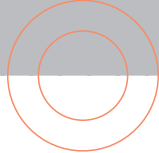

3.5

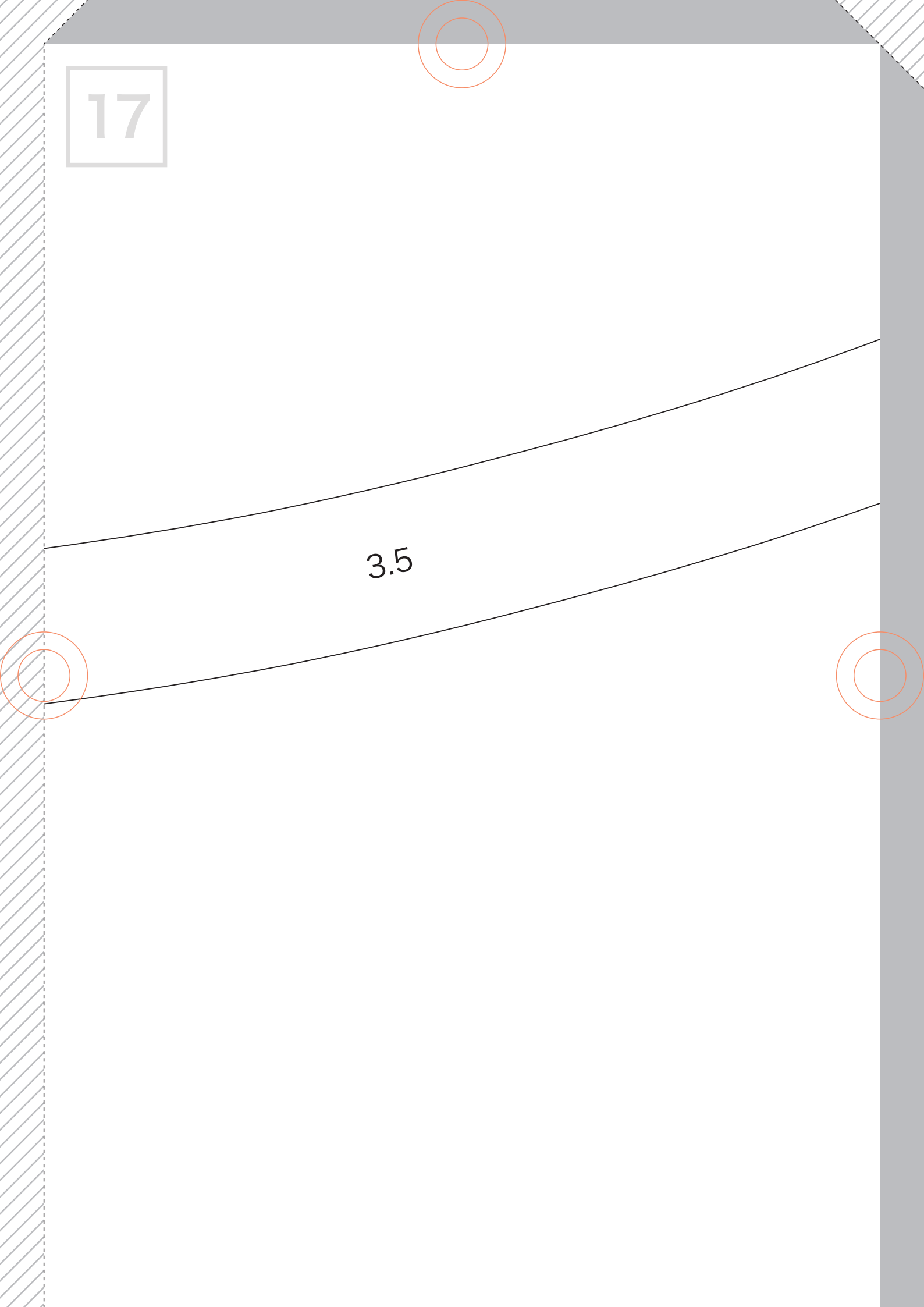

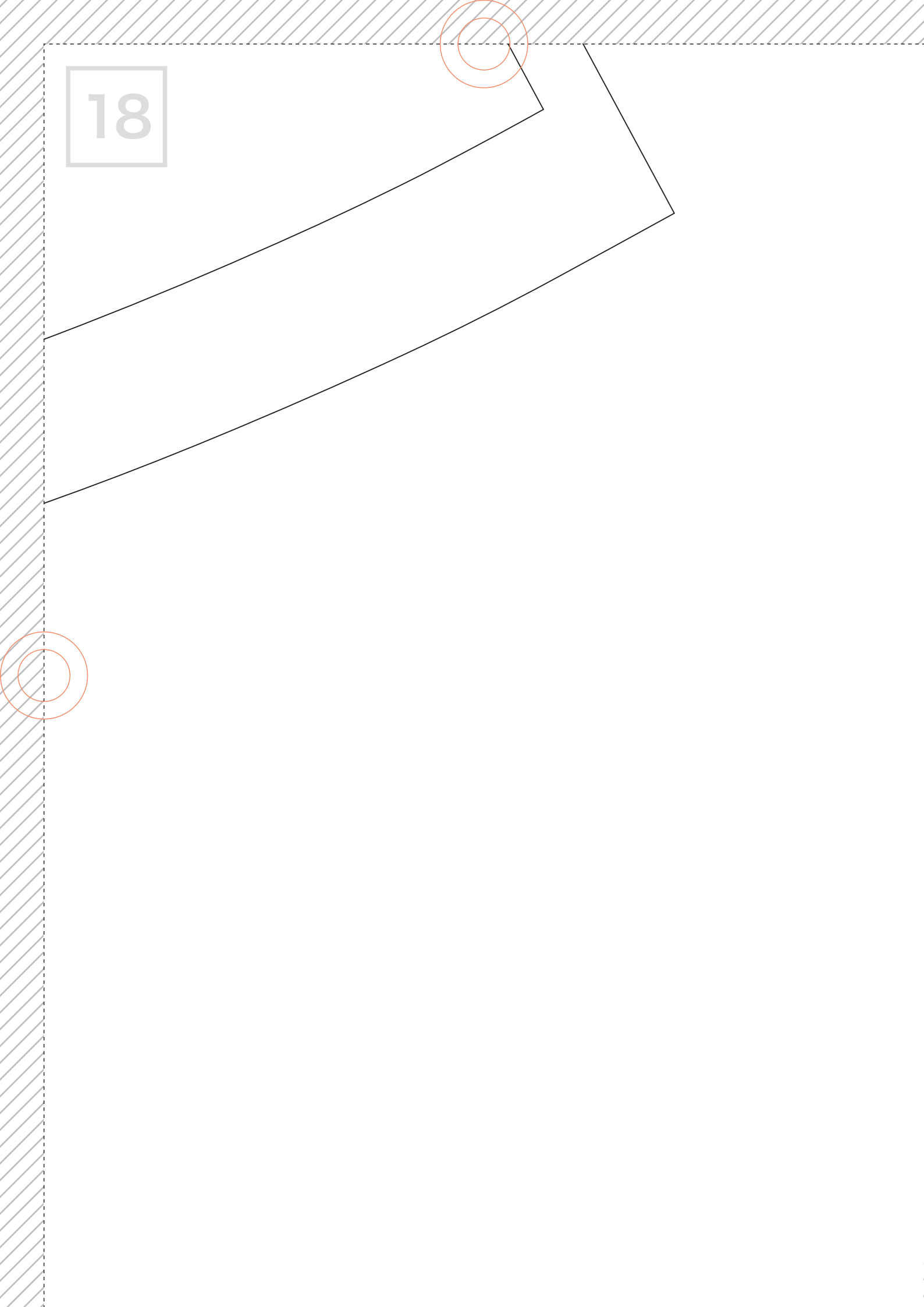

18

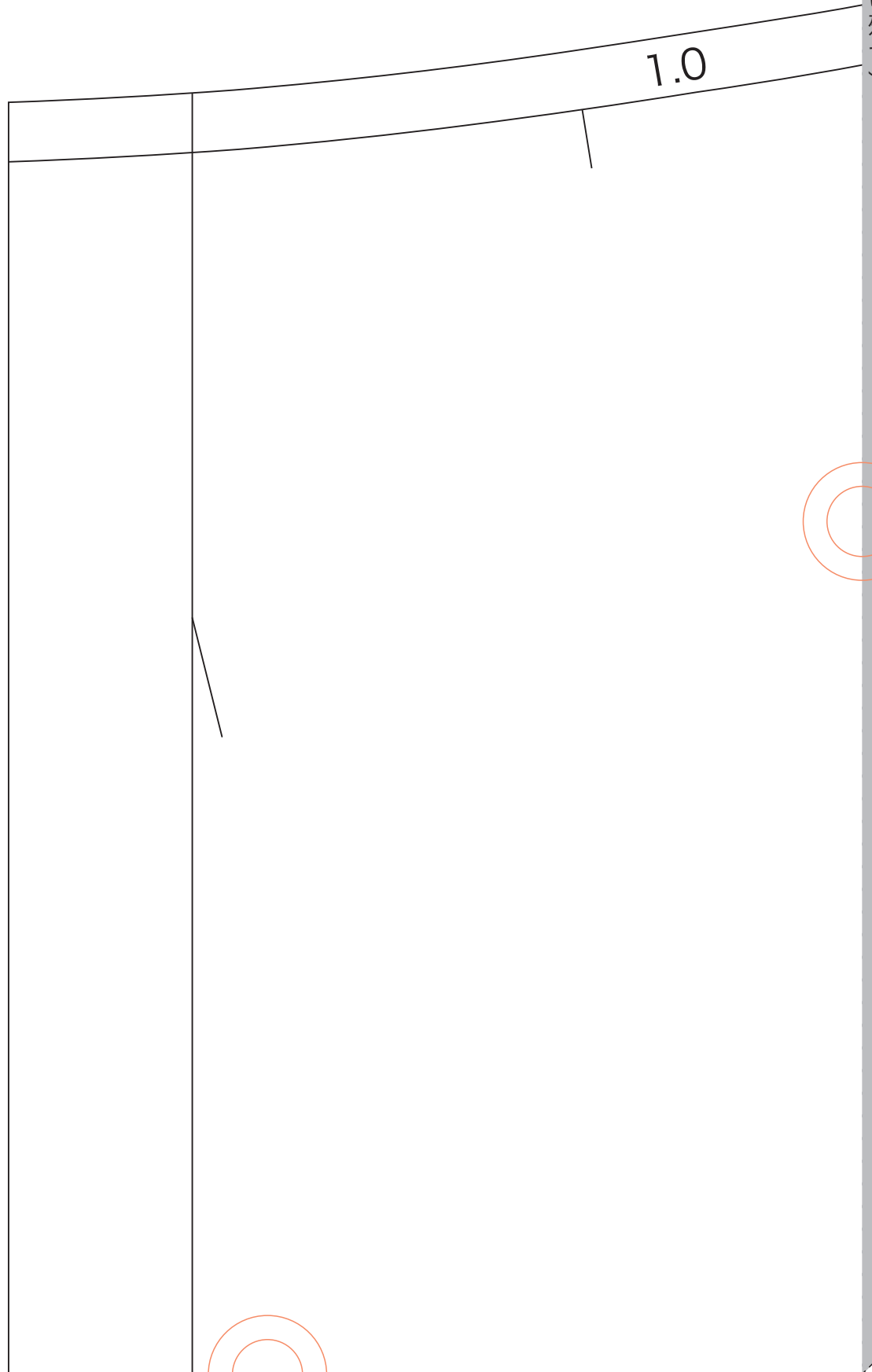

切り取る (斜線部はカット)

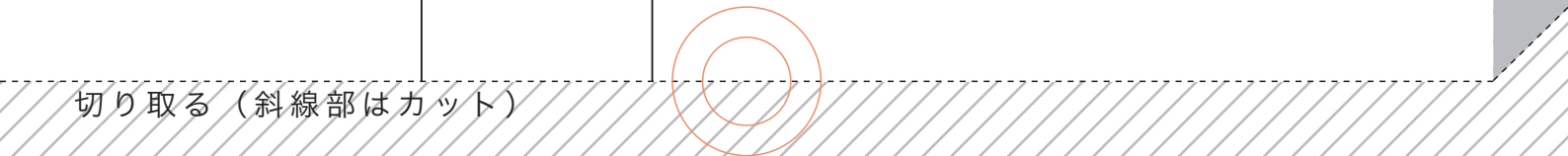

20

ファスナーあきしろ

1.5

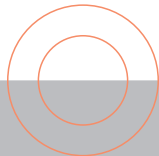
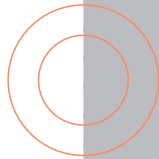
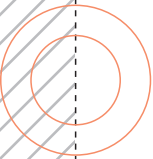

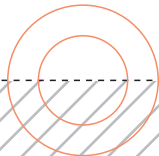
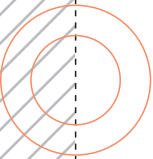

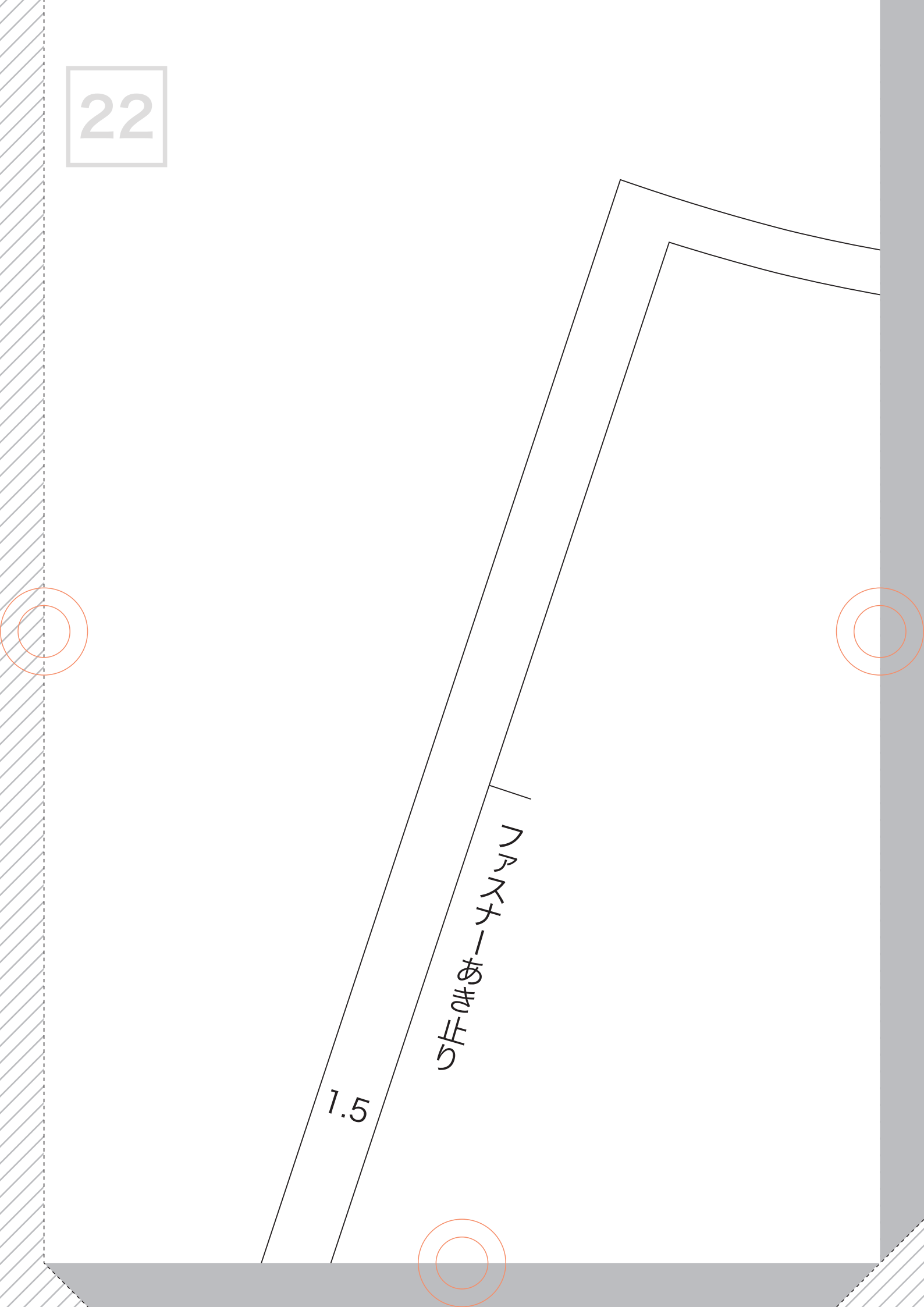

1.5

コンクリート

23

1.0

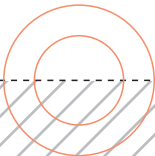
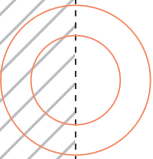

24

B
C

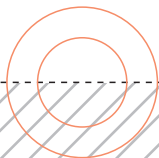
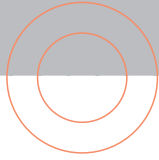

25

f a b f a b-17
裏後ろスカート
size : 9

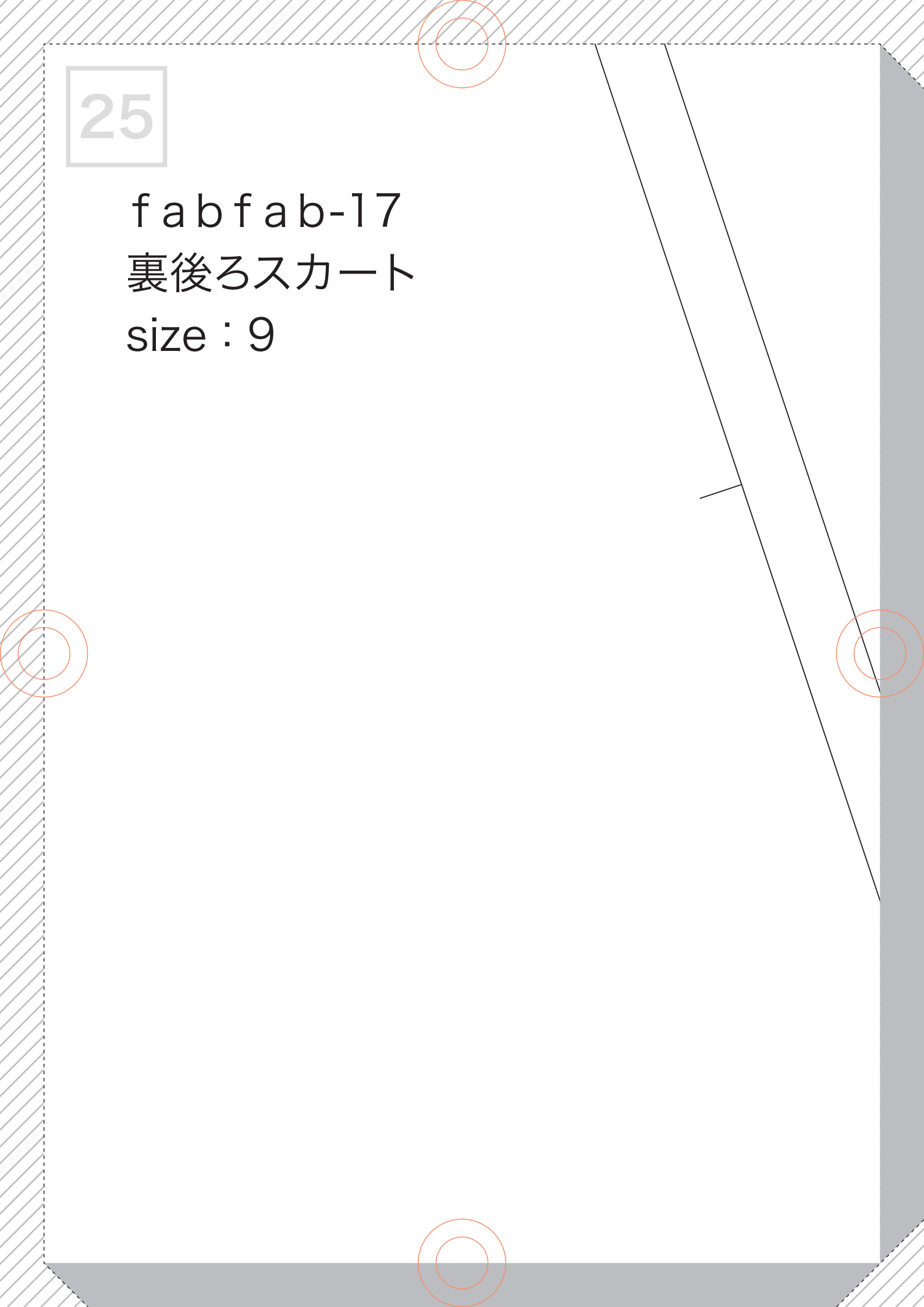

26

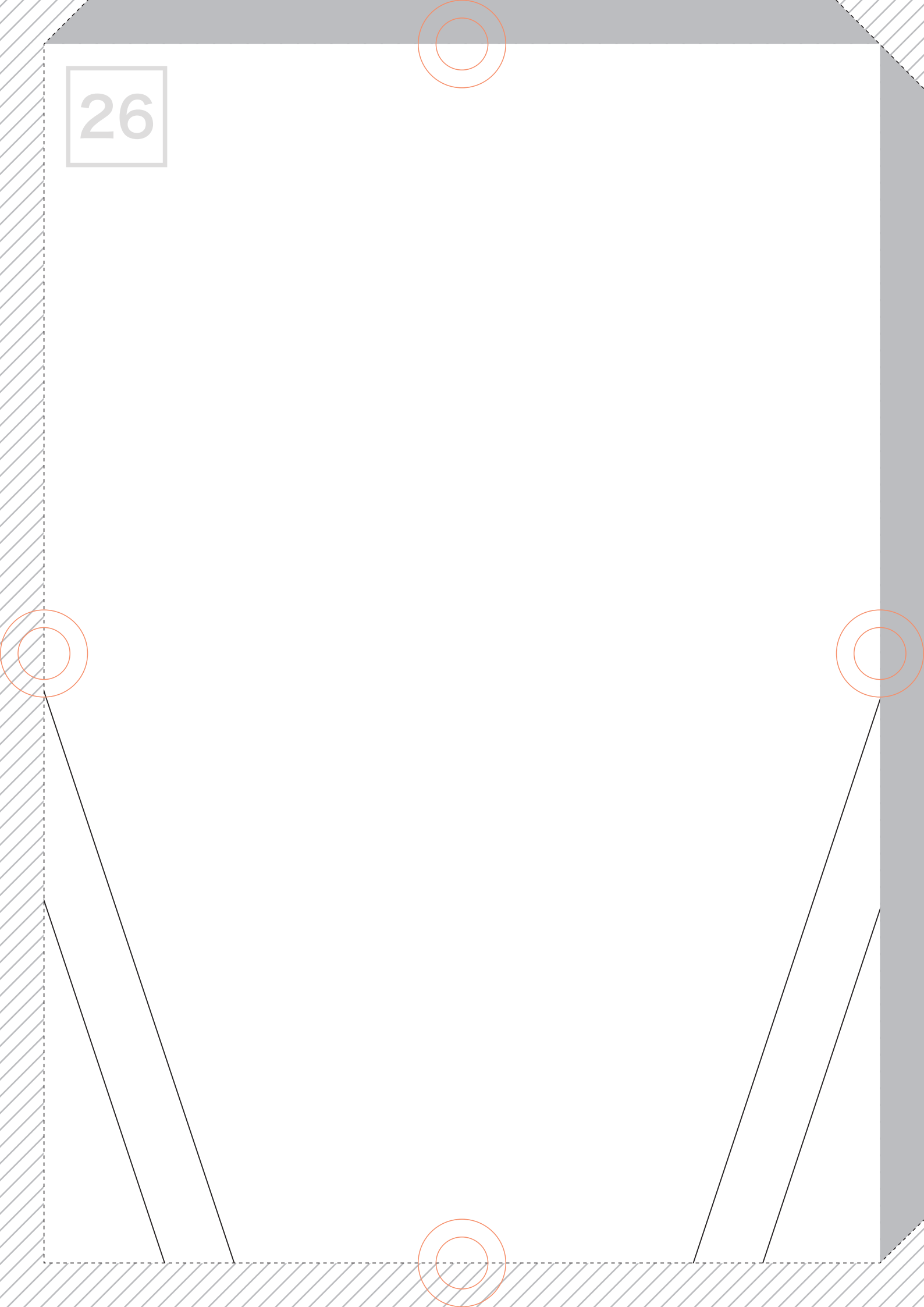
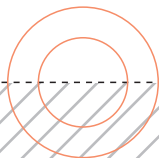
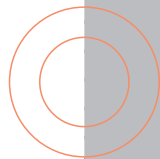
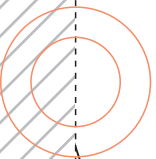
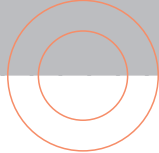

27

fabfab-17
裏前スカート
size : 9

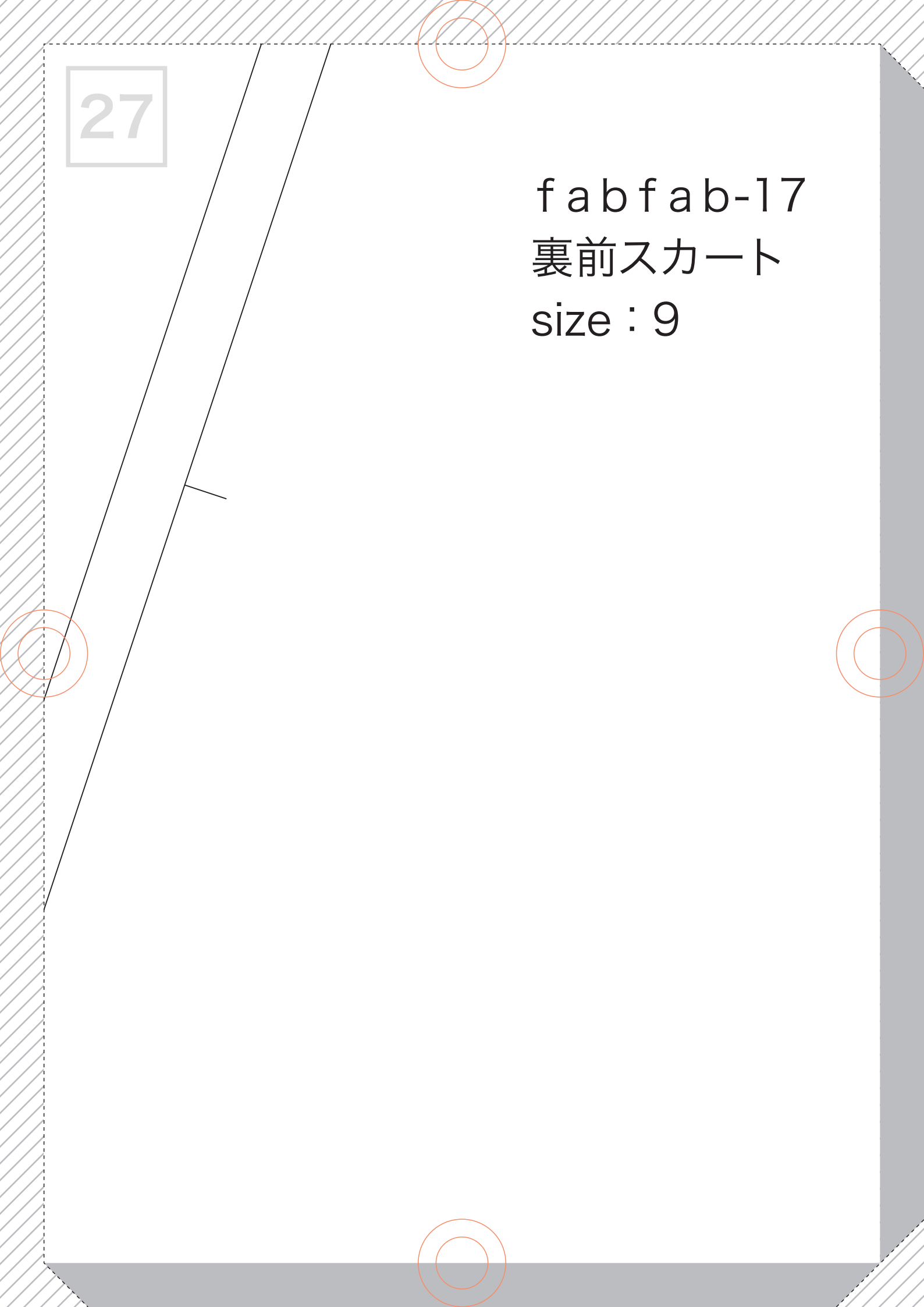

28

CT

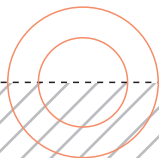
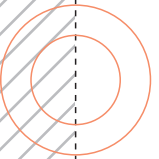
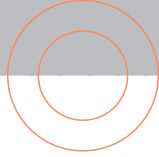

29

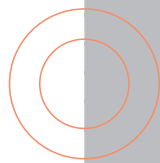

30

2.5

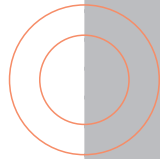
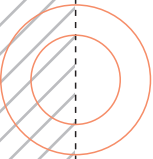
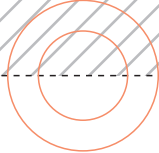

31

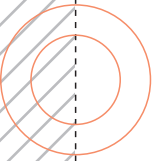
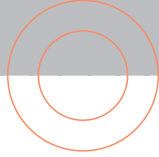

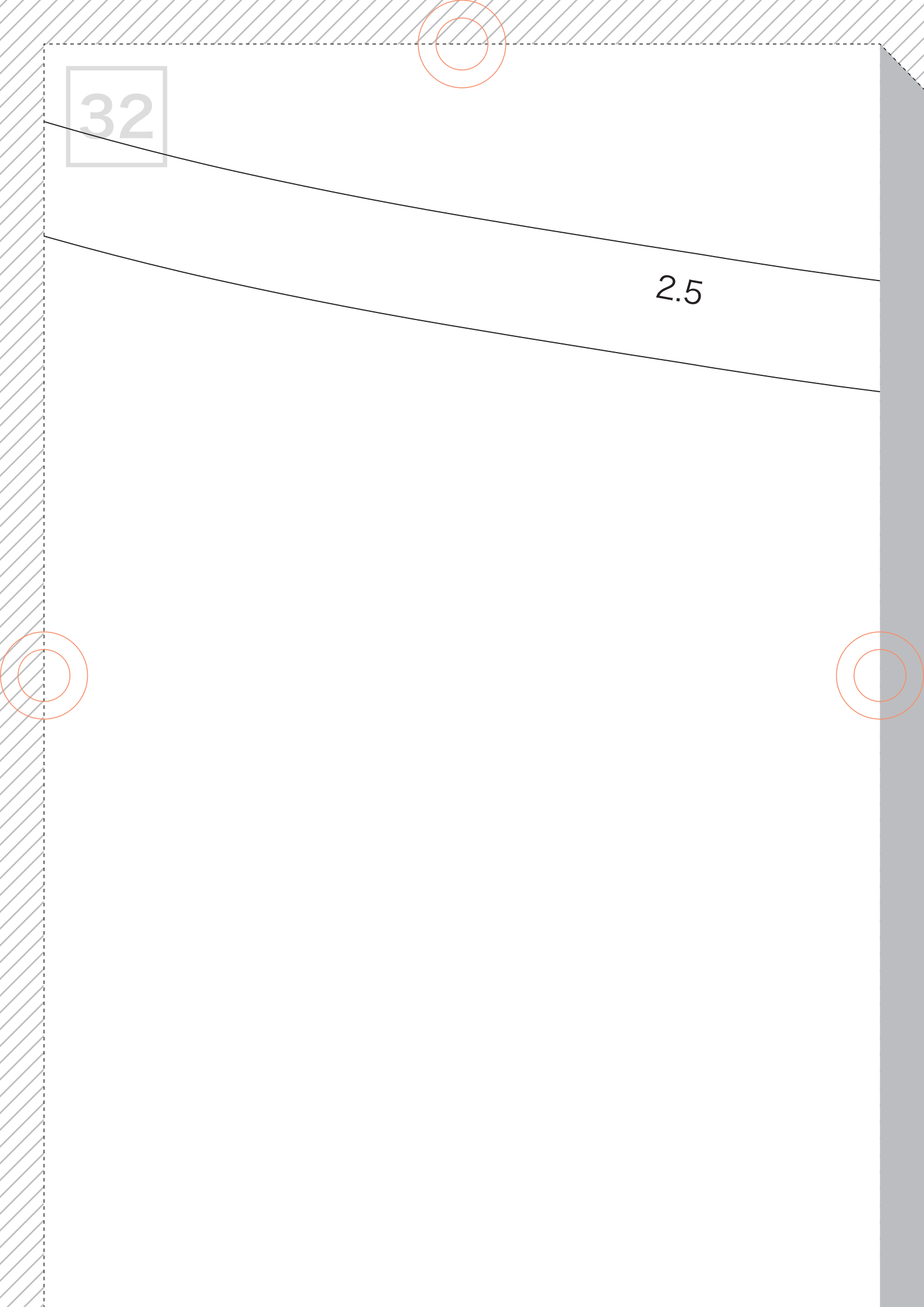

32

2.5

33

