

## introduction はじめに

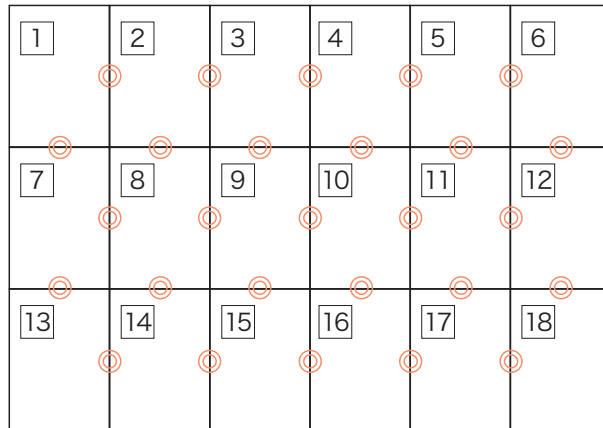

パターンは A4 サイズ 18 枚に分割されています。  
印刷後、右図のようにつなぎ合わせてください。

### ! 印刷時の注意

印刷設定では、「ページの拡大や縮小」を選択せず  
必ず、「実際のサイズ」(原寸) で印刷してください。



## how to make パターンのつくりかた

**STEP1** 斜線部分  は切り取り、灰色部分  は残してのりしろにします。  
(斜線と灰色を間違えないように注意)

**STEP2** 各用紙の番号を確認し、 の位置を合わせて、のりづけします。  
(水のりは用紙が波打ちます。スティック糊などをお使いください)

**STEP3** それぞれのパーツをハサミで切り出します。

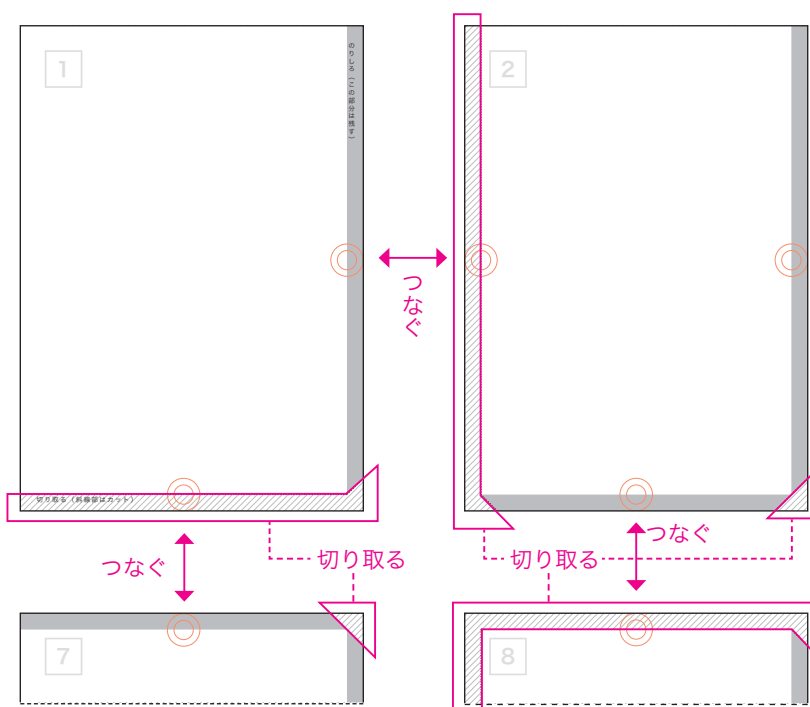

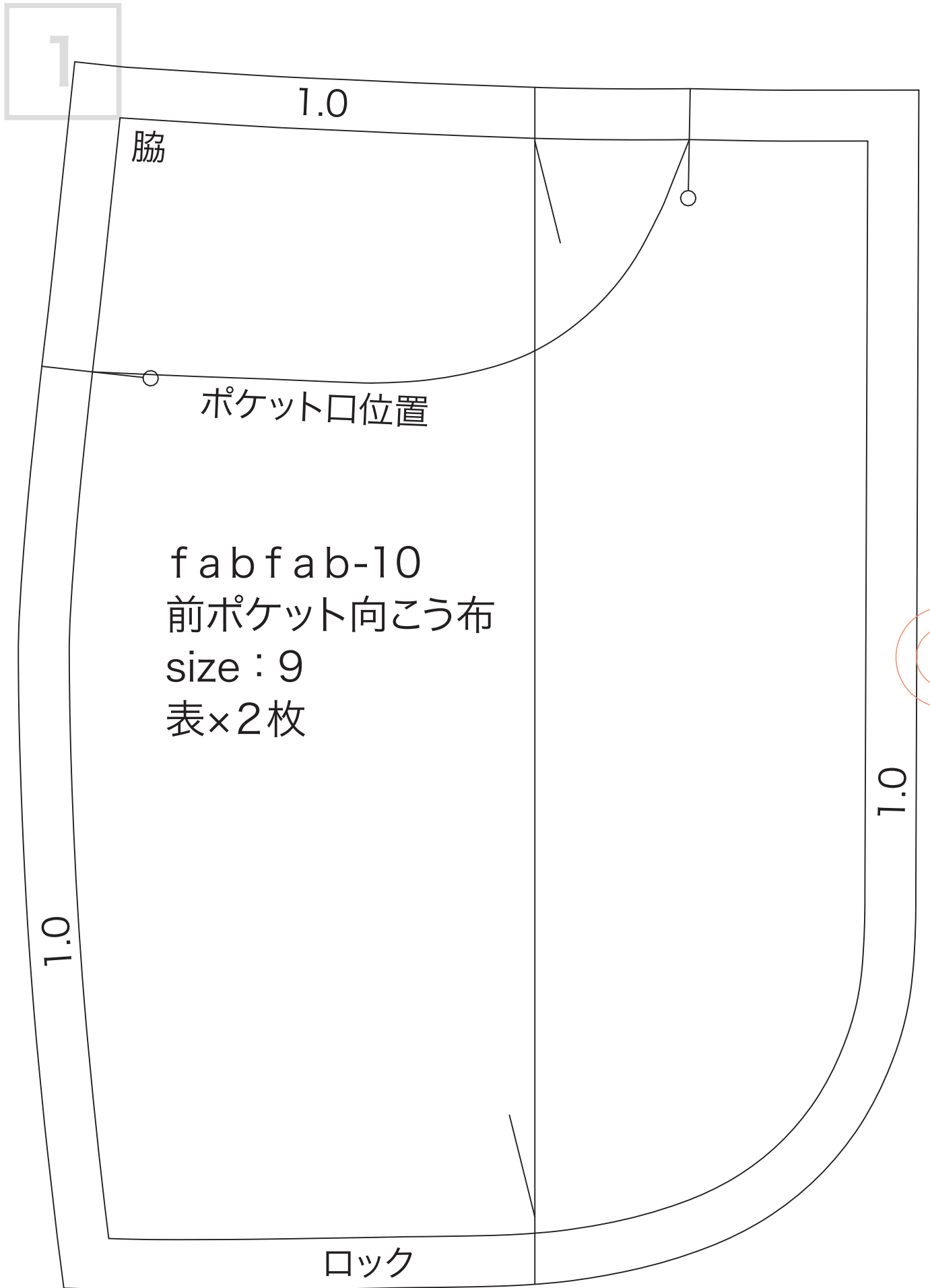

2

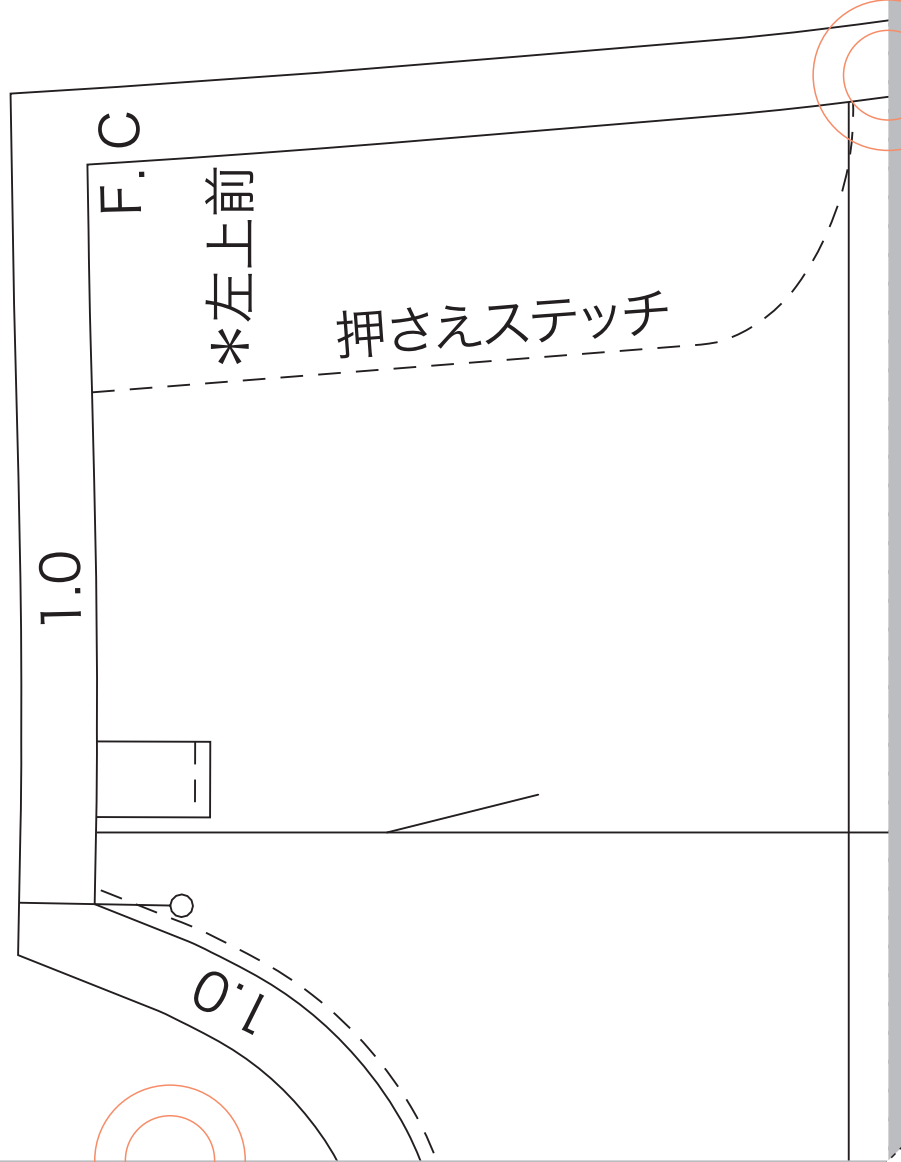

3

1.0

fabfab-10

前パンツ

size : 9

表×2枚

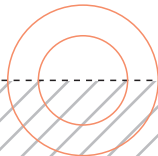
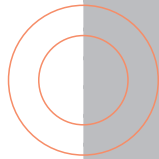
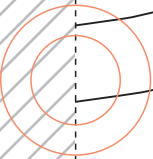

4

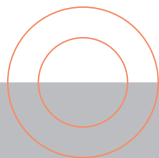
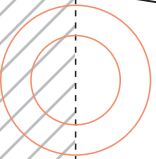
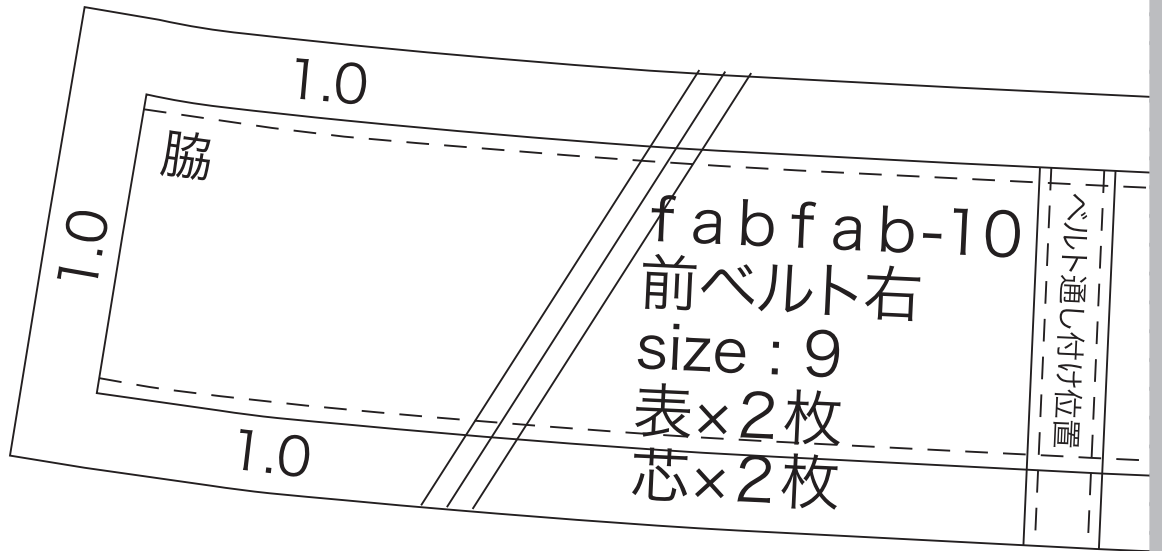

5

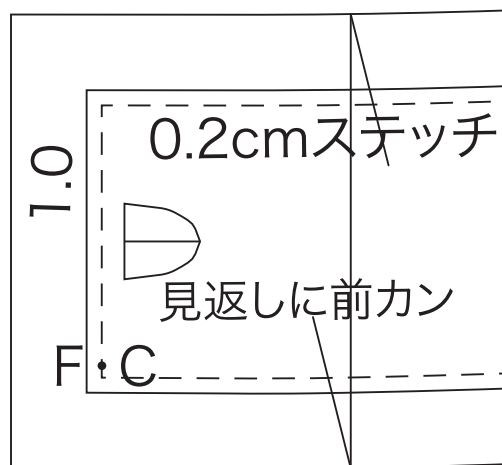
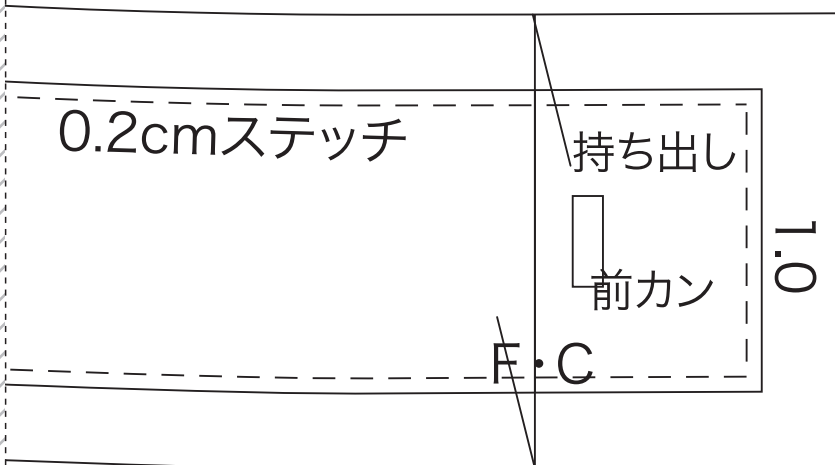

1.0

6

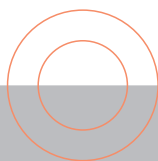
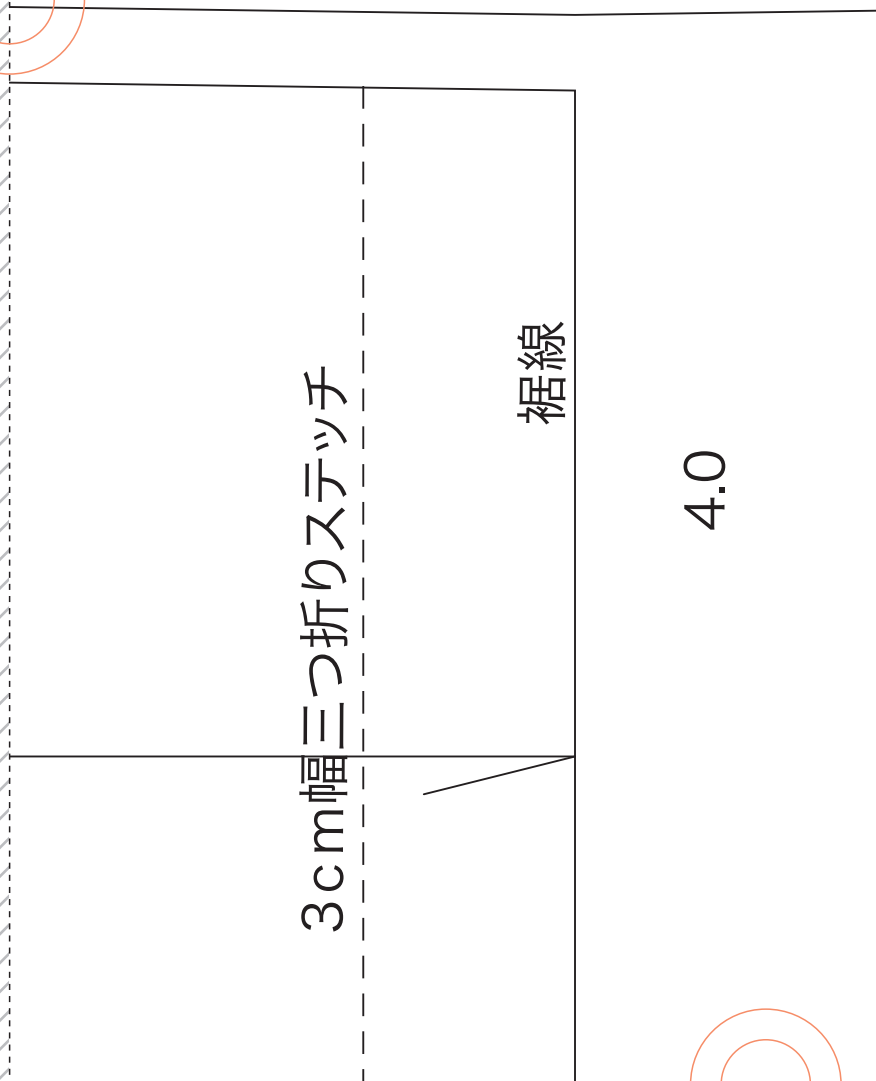
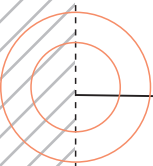
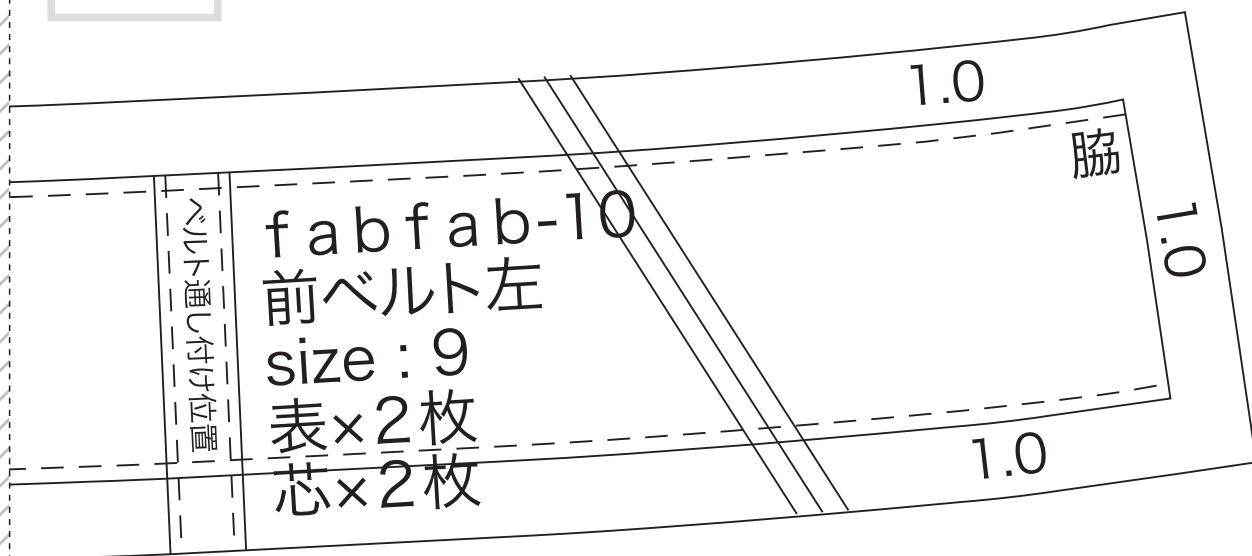

7

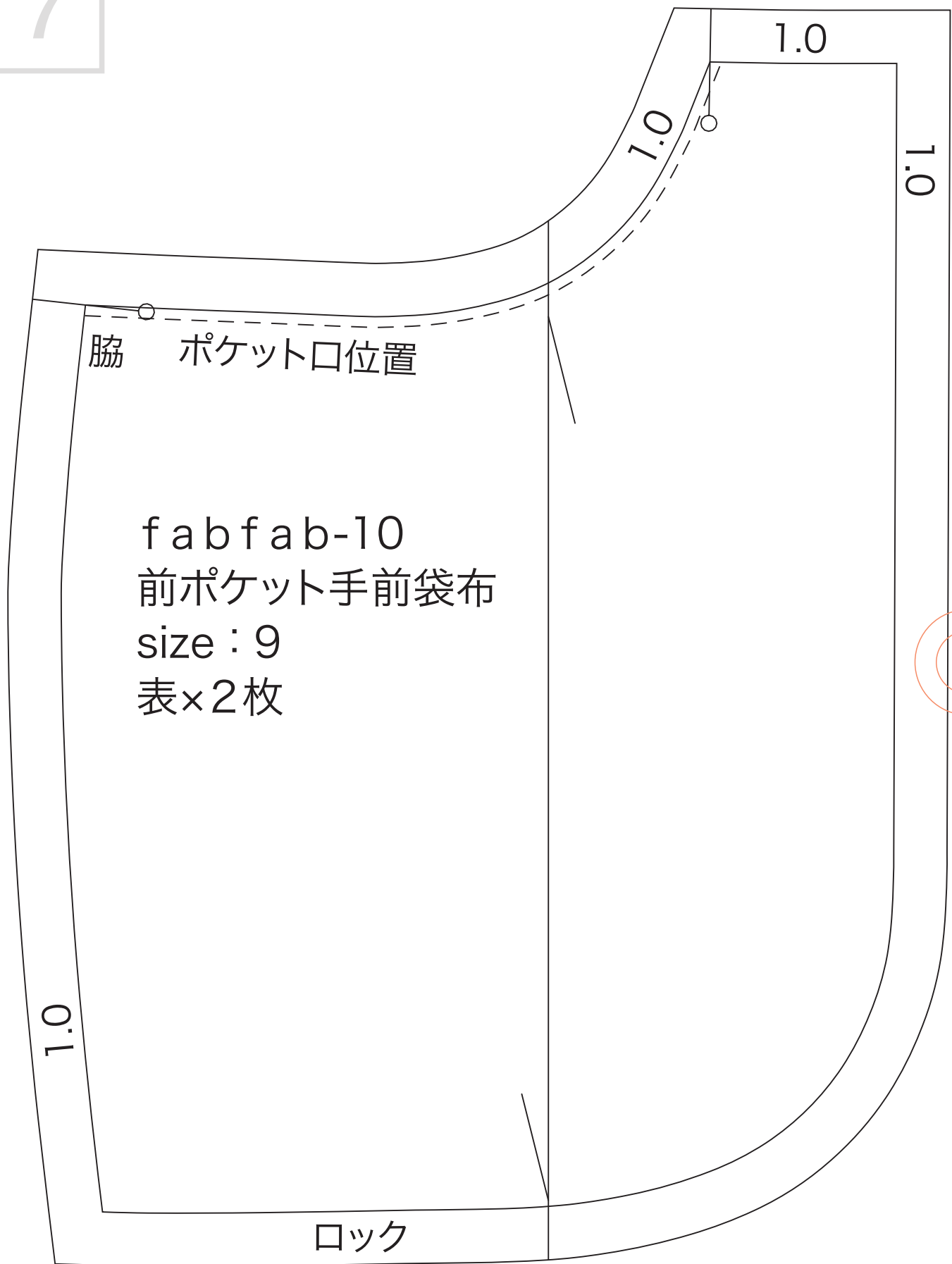

脇 ポケット口位置

fabfab-10  
前ポケット手前袋布  
size: 9  
表x2枚

ロック



8

ポケット口位置

脇

1.0

脇

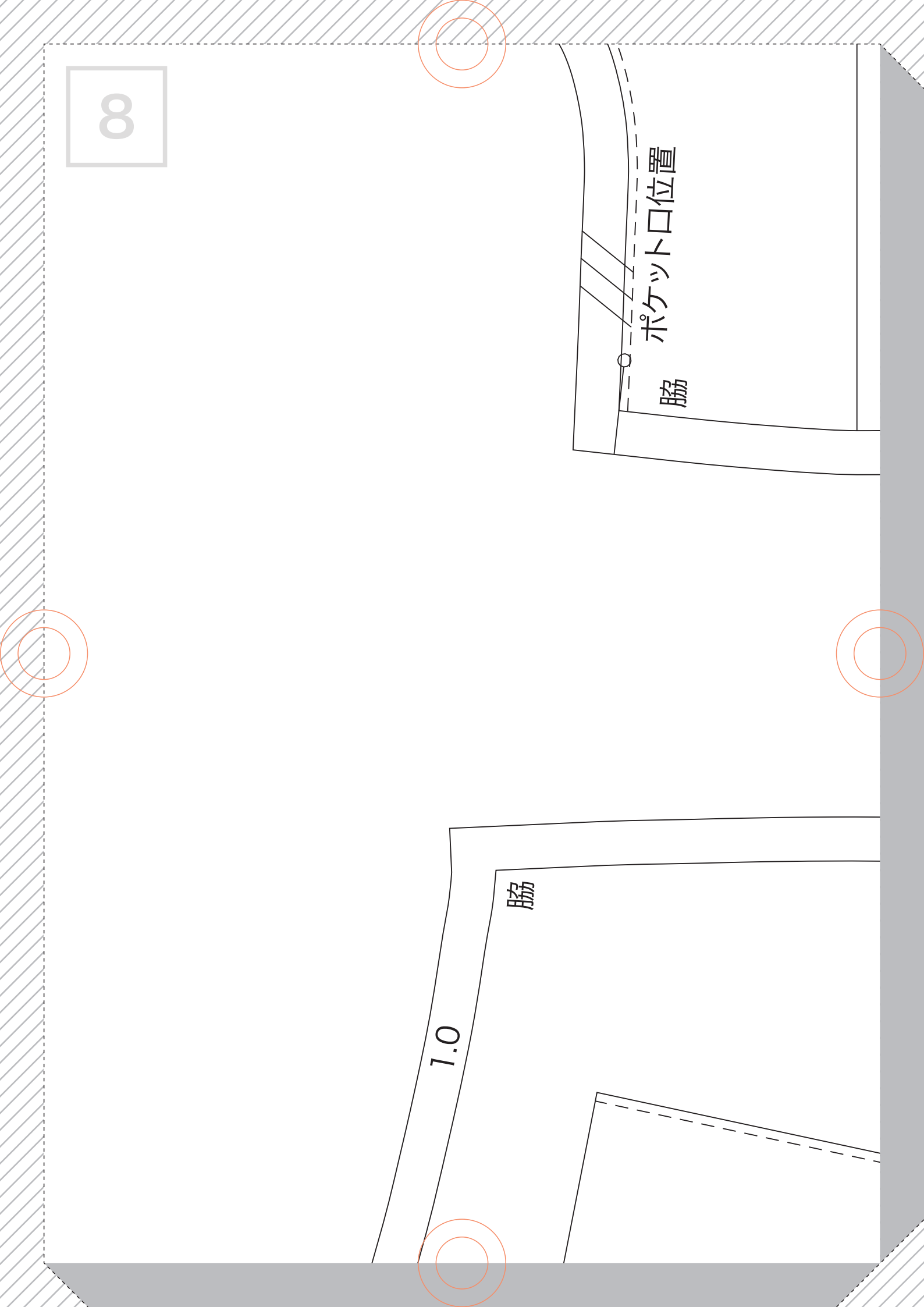

9

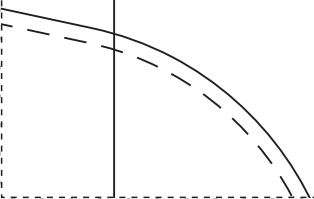
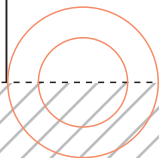
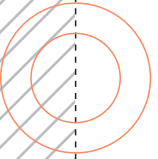
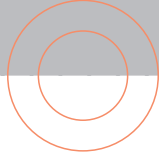

10

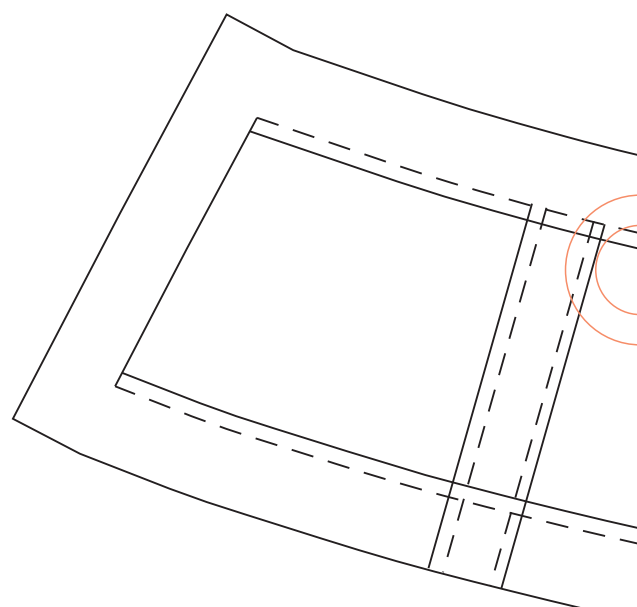
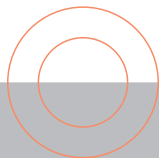
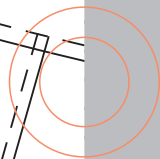
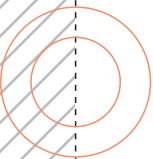
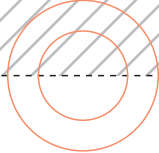

11

0'L

fabfab-10  
後ベルト  
size : 9  
表×2枚  
芯×2枚

B C

1.0

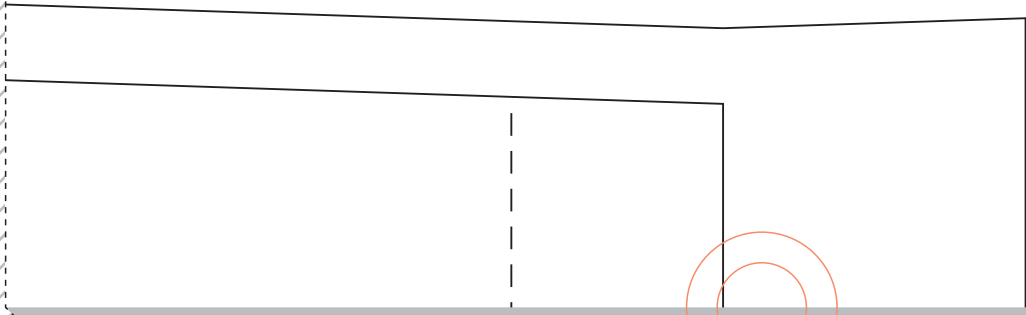
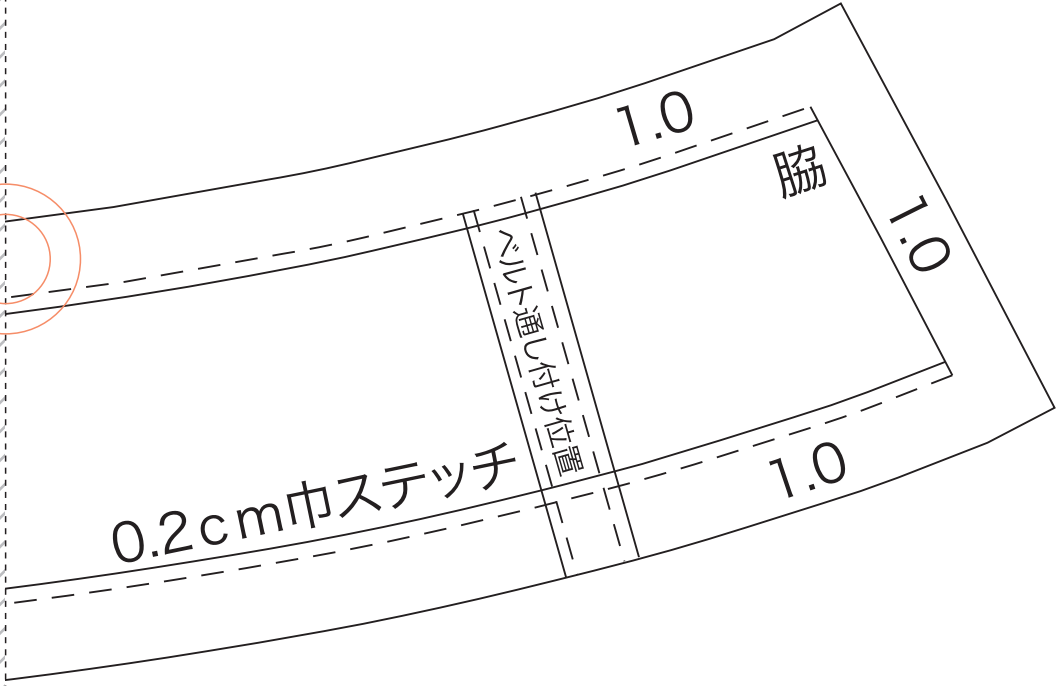
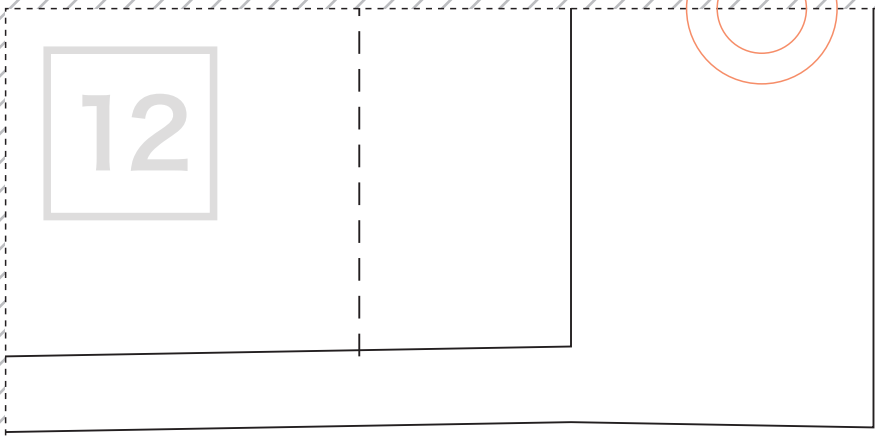

13

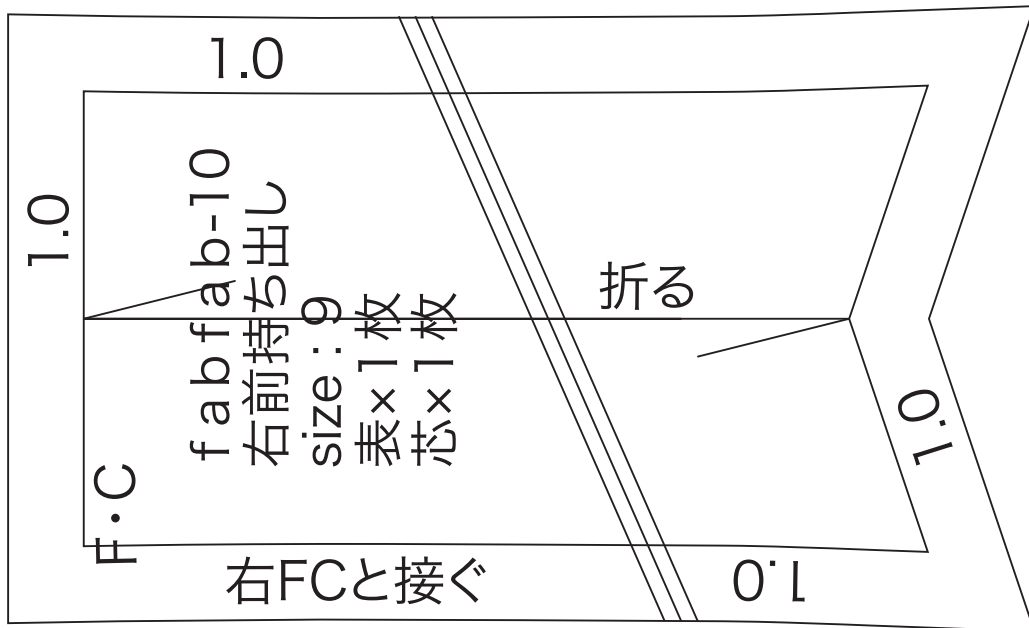
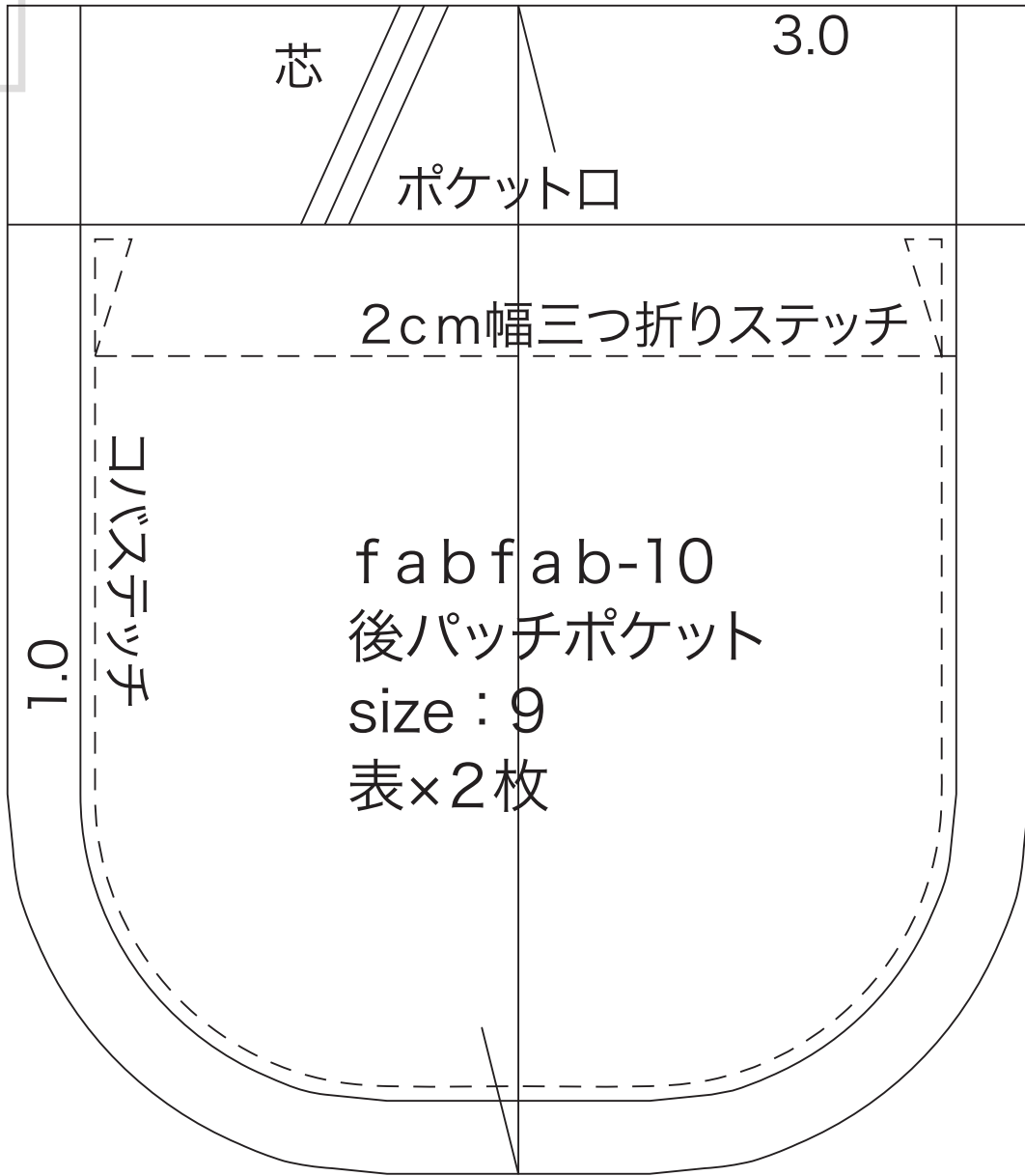

14

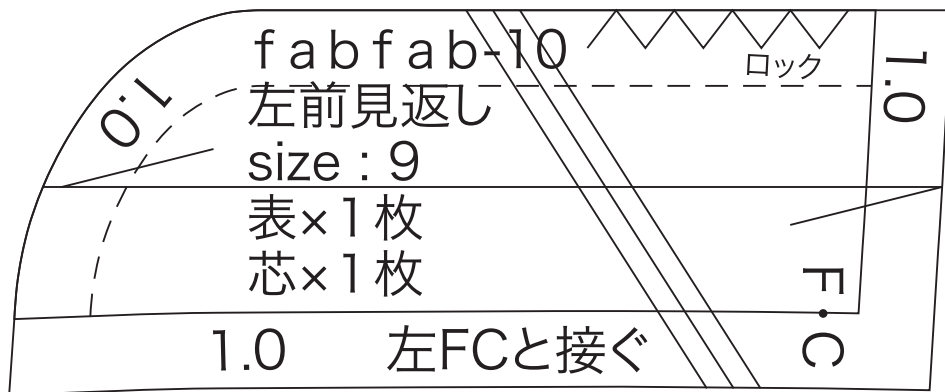
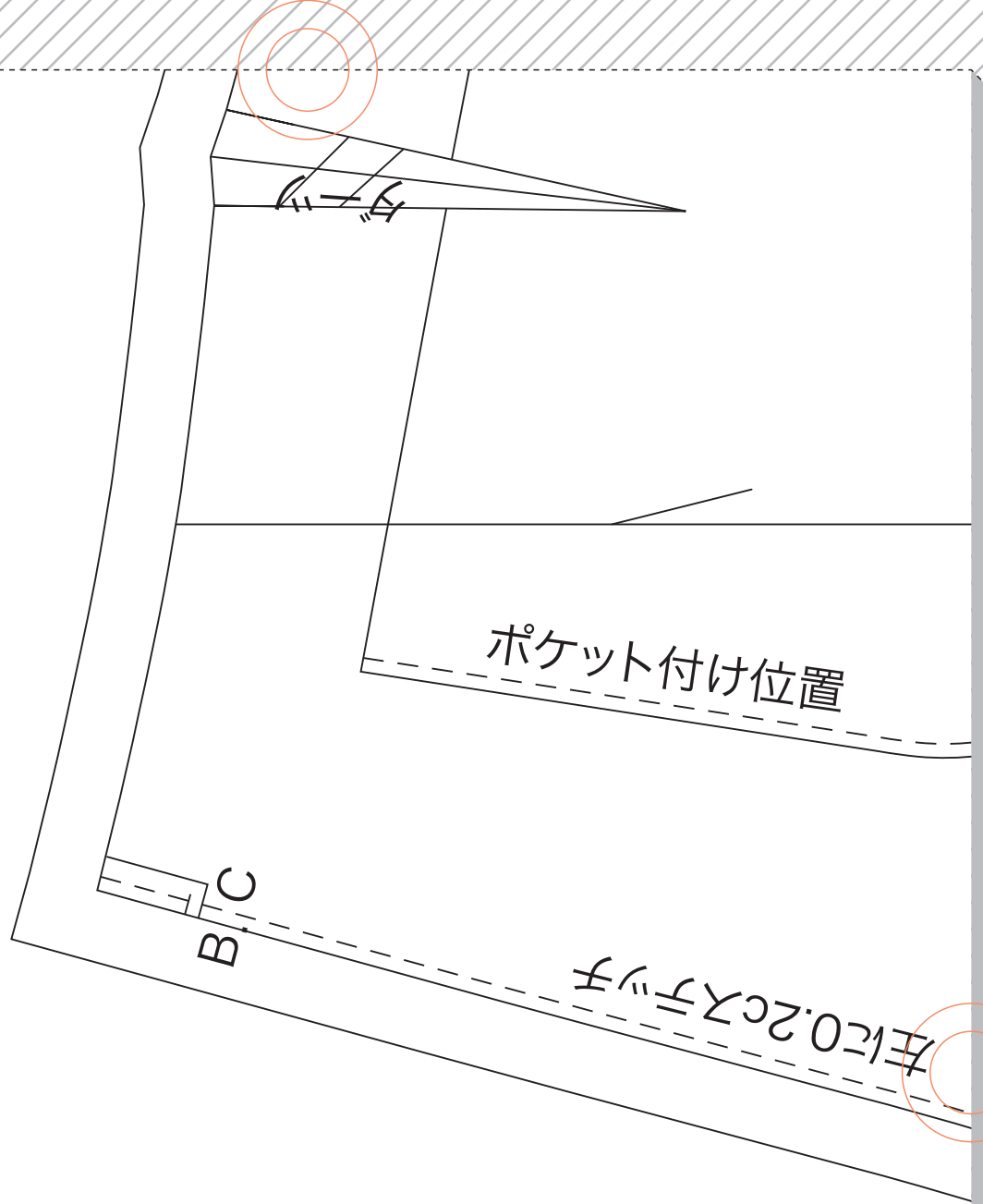

fabfab-10

後パンツ

size : 9

表×2枚

15

10

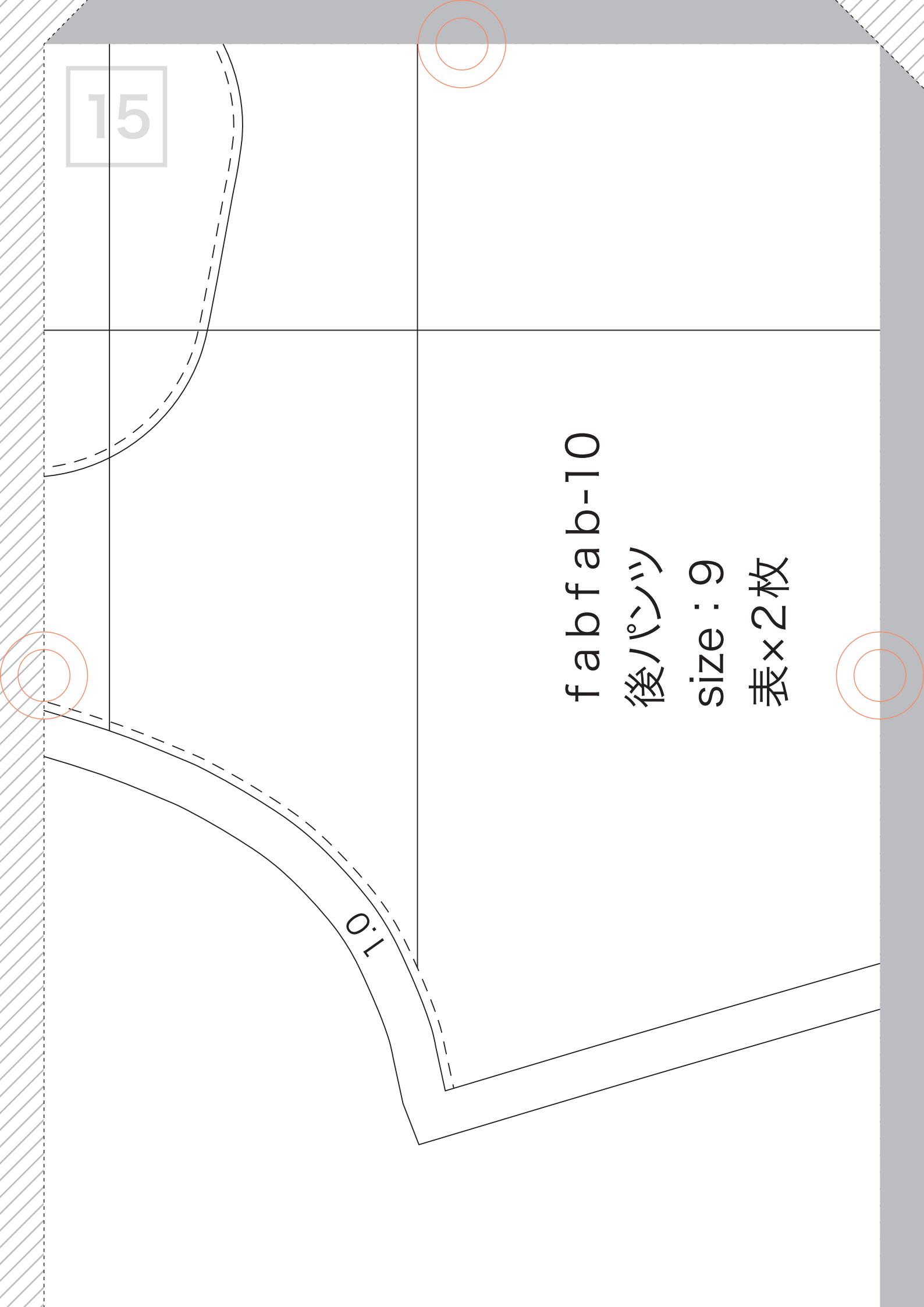



16

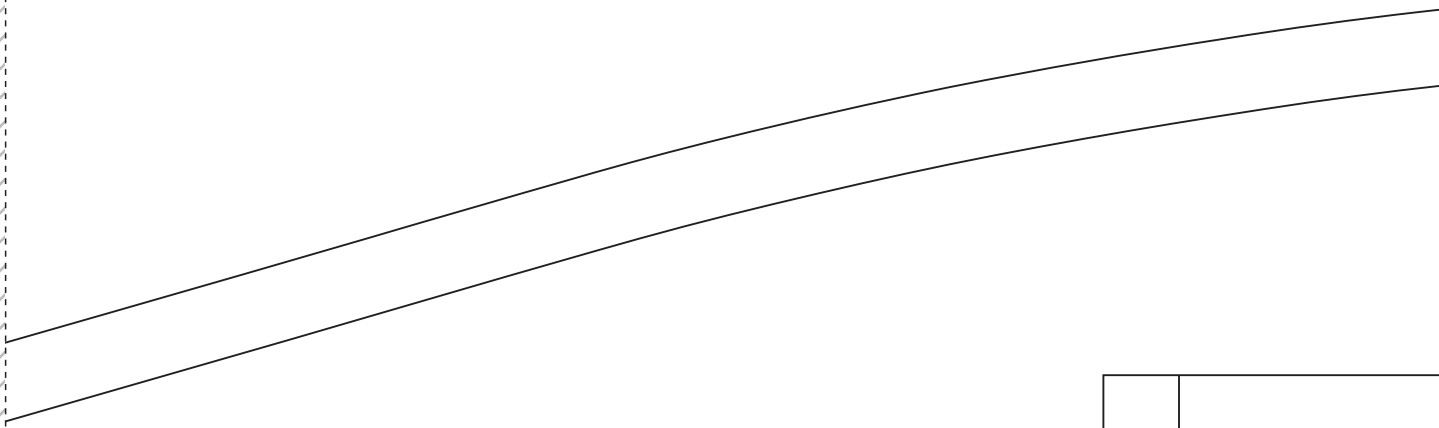
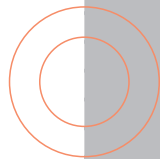
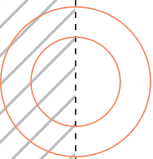
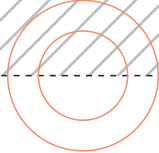

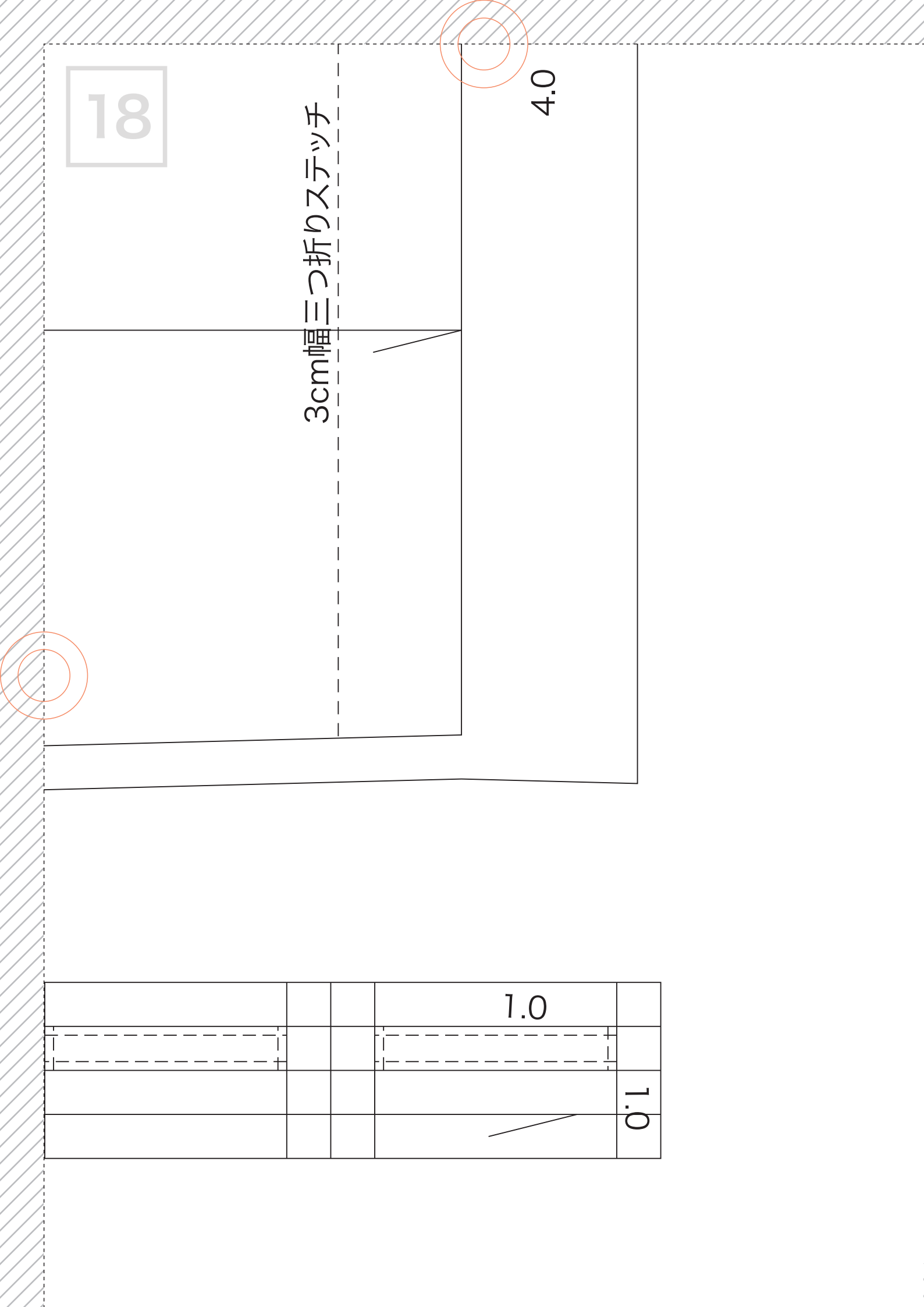

			1.0	
				0.1