

introduction はじめに

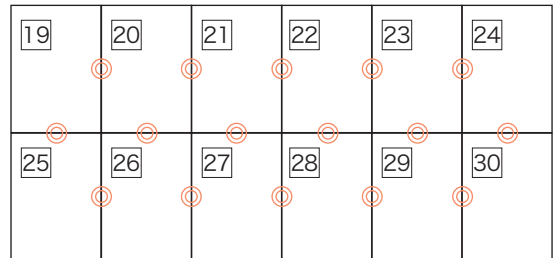
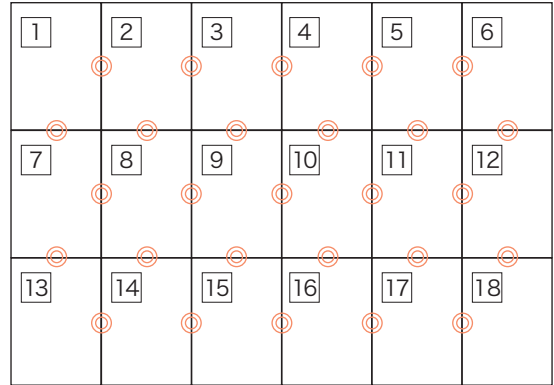

パターンは A4 サイズ 30 枚に分割されています。
印刷後、右図のようにつなぎ合わせてください。

! 印刷時の注意

印刷設定では、「ページの拡大や縮小」を選択せず
必ず、「実際のサイズ」(原寸) で印刷してください。



how to make パターンのつくりかた

STEP1 斜線部分  は切り取り、灰色部分  は残してのりしろにします。
(斜線と灰色を間違えないように注意)

STEP2 各用紙の番号を確認し、 の位置を合わせて、のりづけします。
(水のりは用紙が波打ちます。スティック糊などをお使いください)

STEP3 それぞれのパーツをハサミで切り出します。

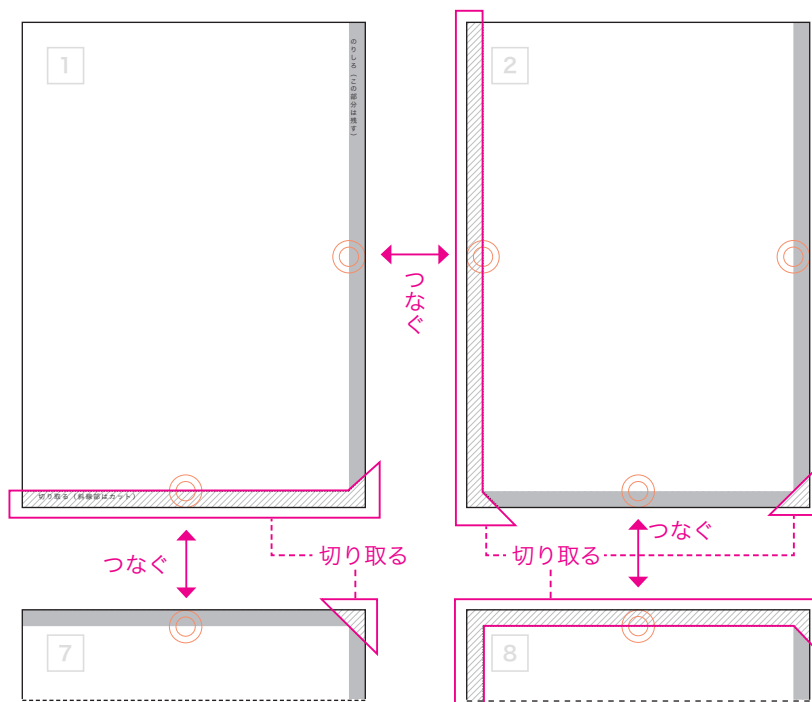

1

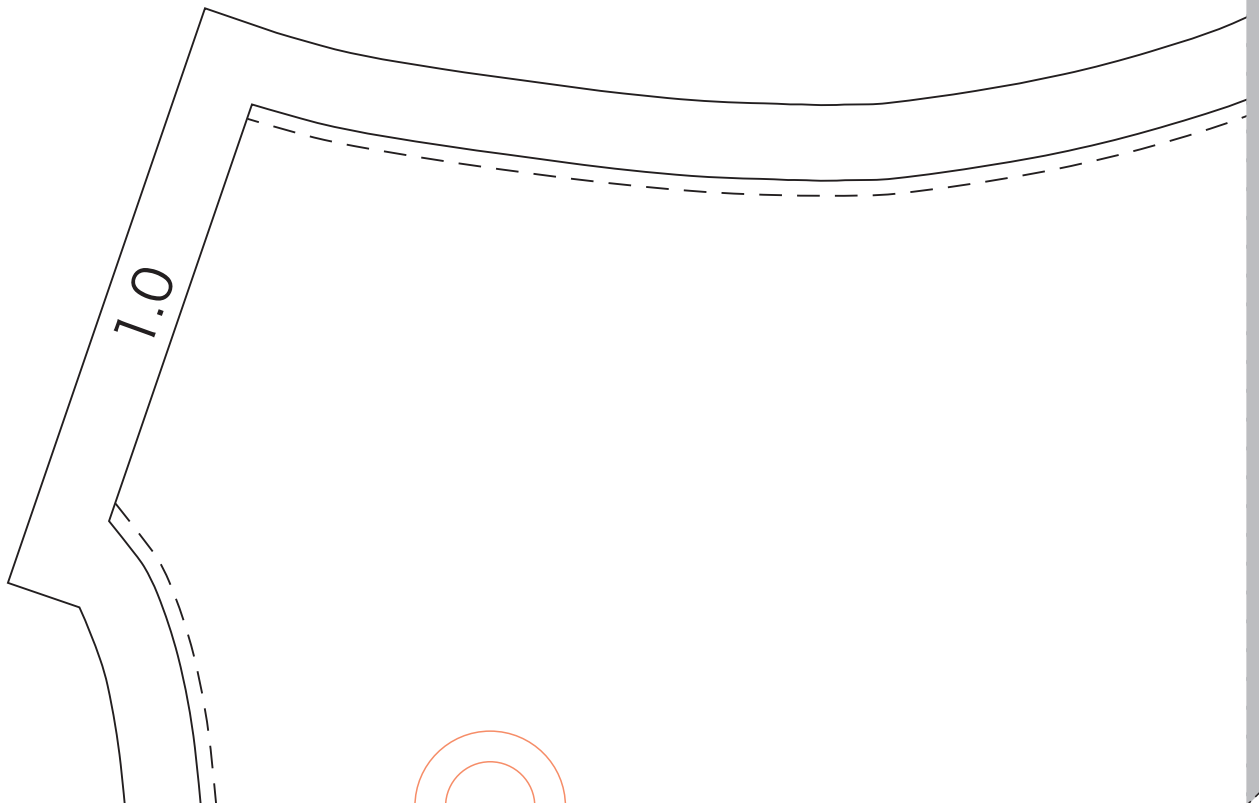

切り取る (斜線部はカット)

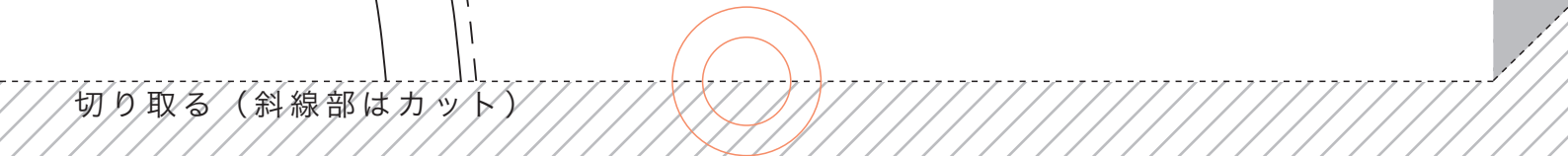

2

fabfab-11

後身頃

size : 11

表×2枚

脇

1.0

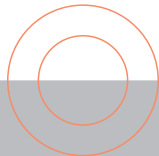
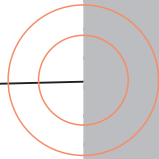
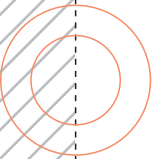

3

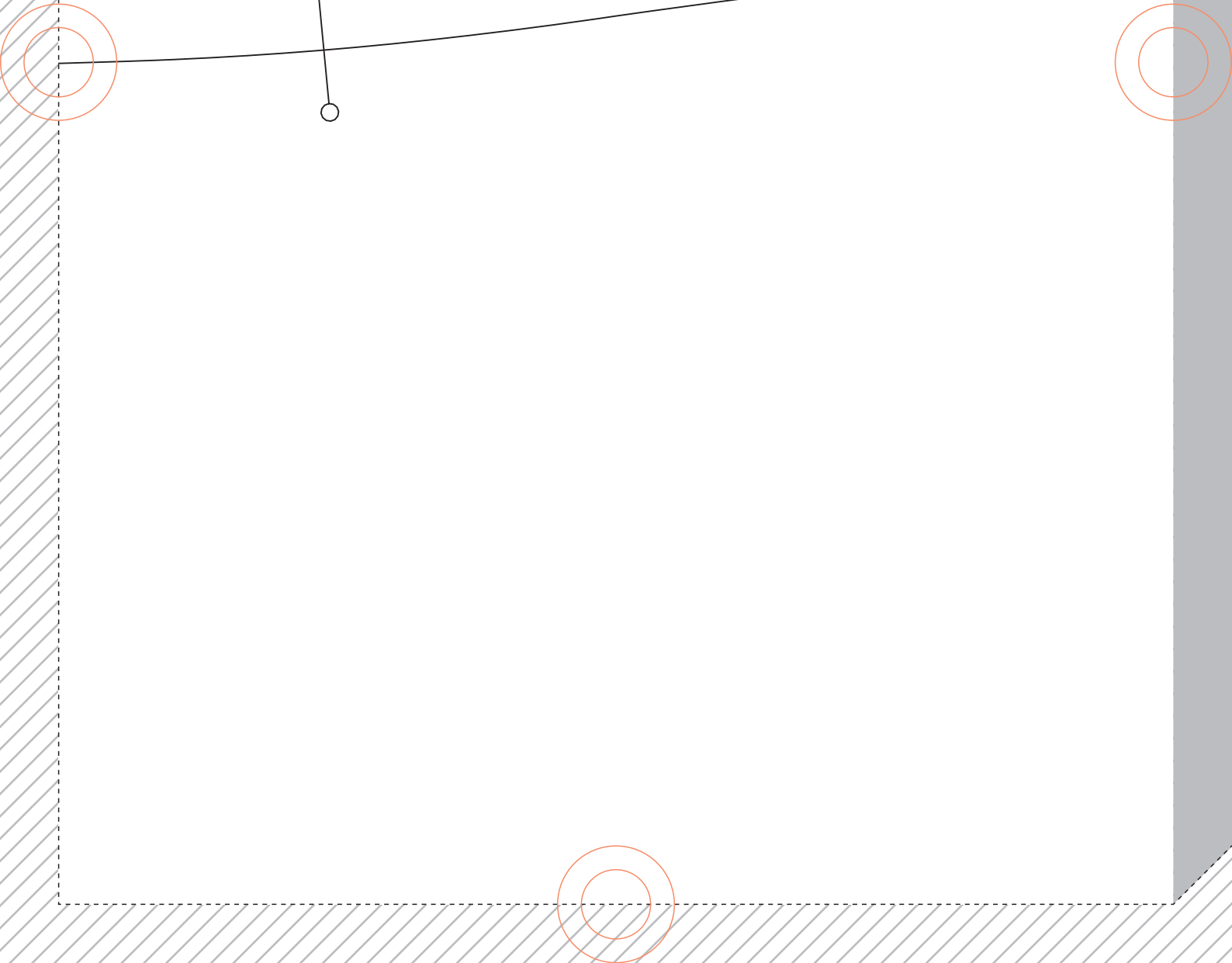

4

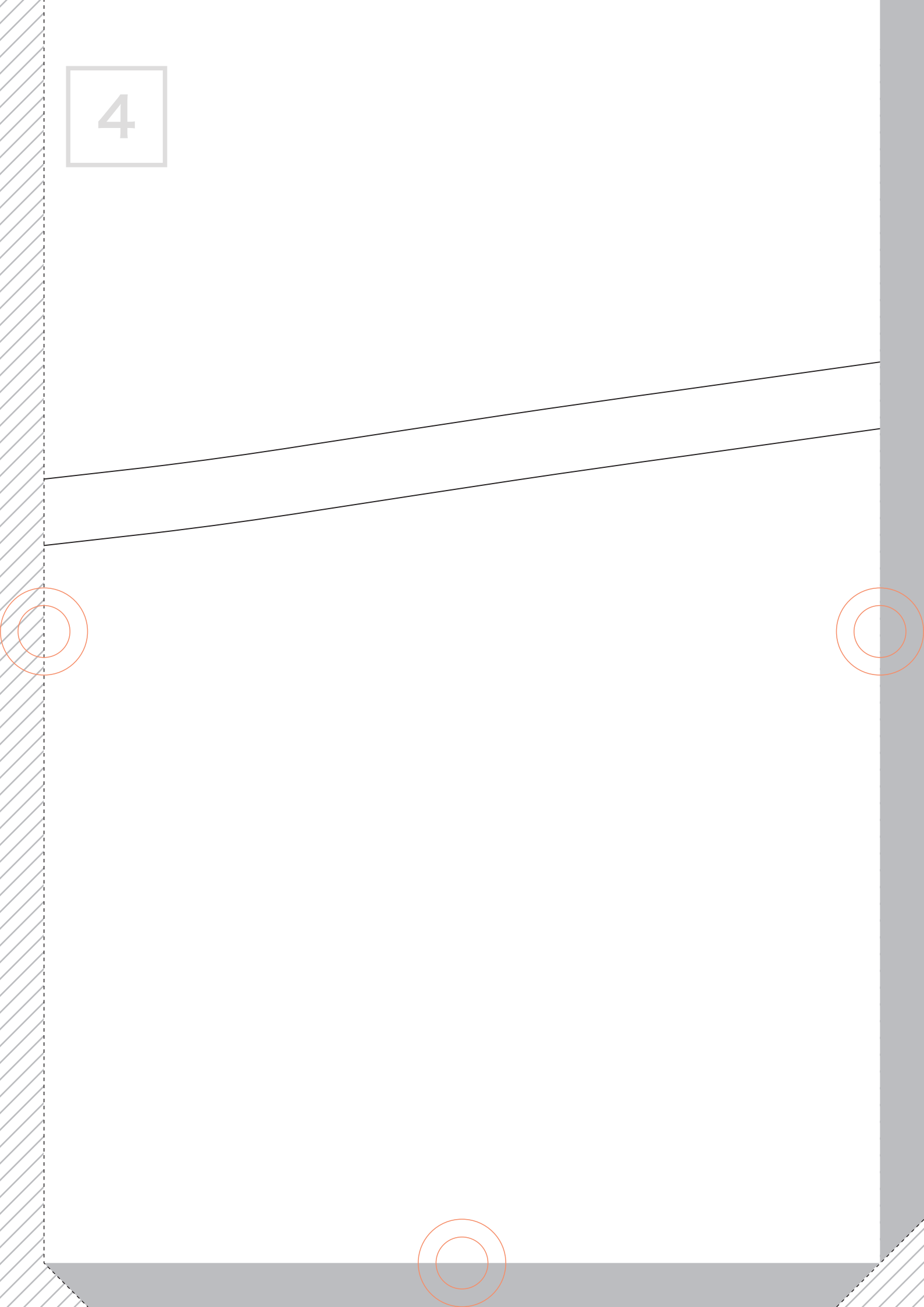

5

1.5

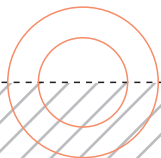
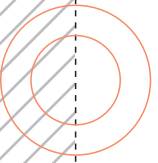

6

2.5cm幅三つ折りステッチ

裾出来上がり線

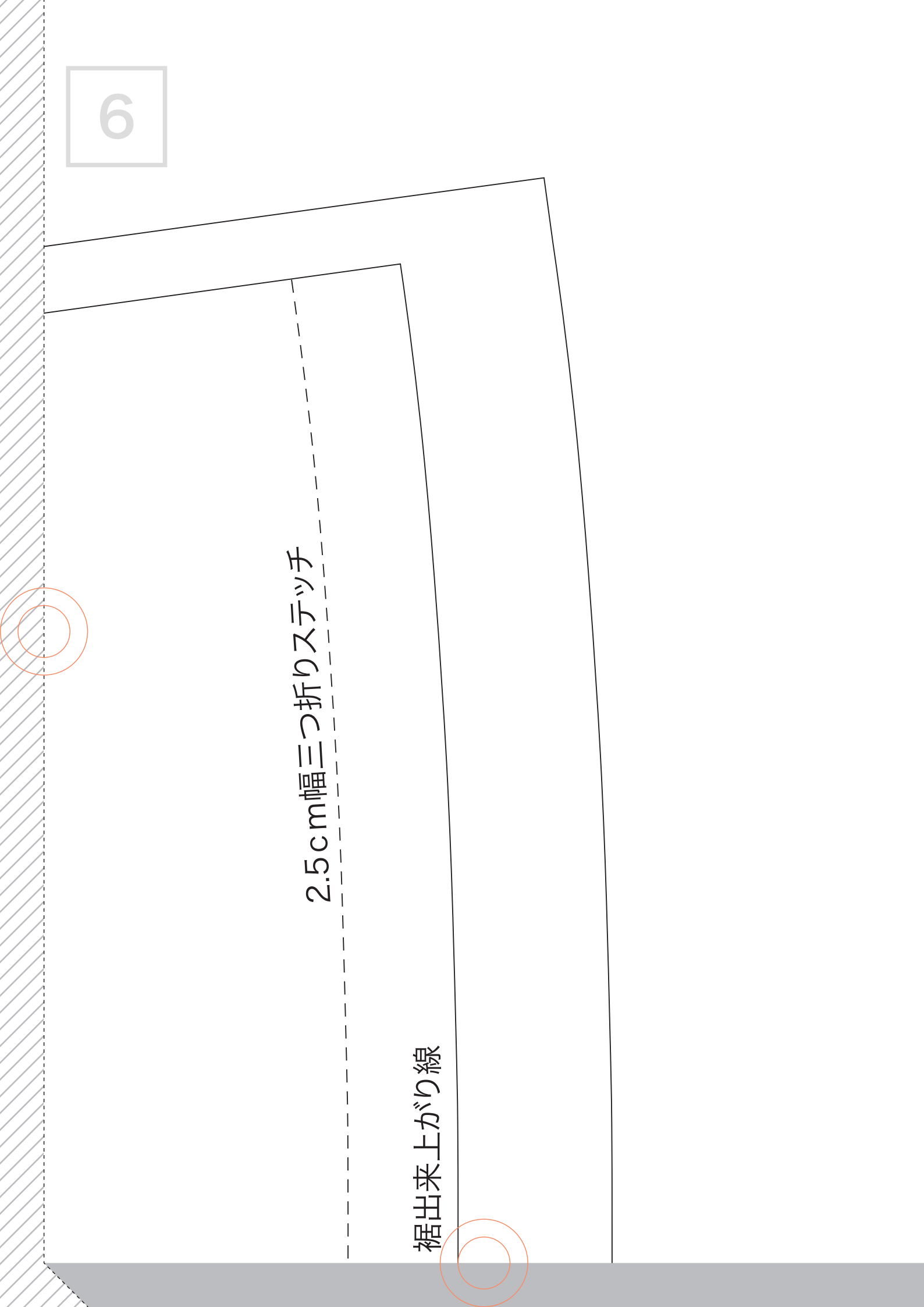

7

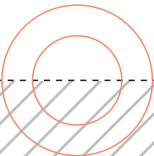
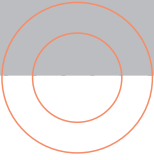
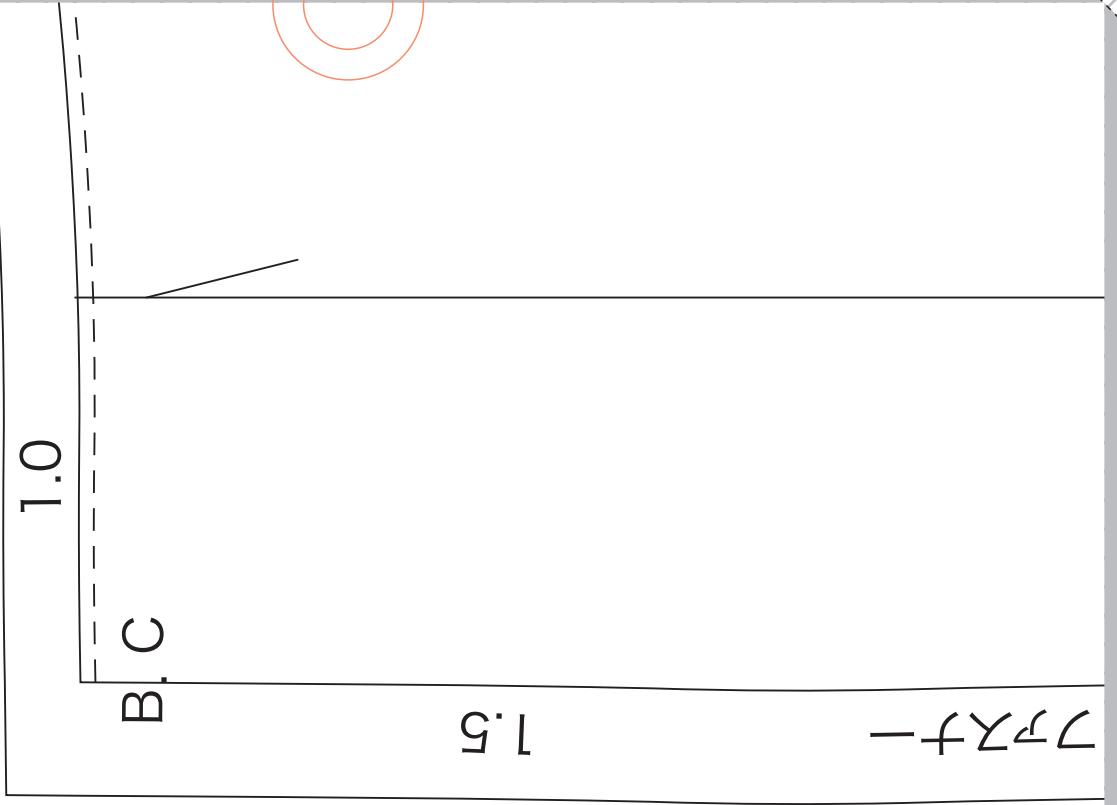

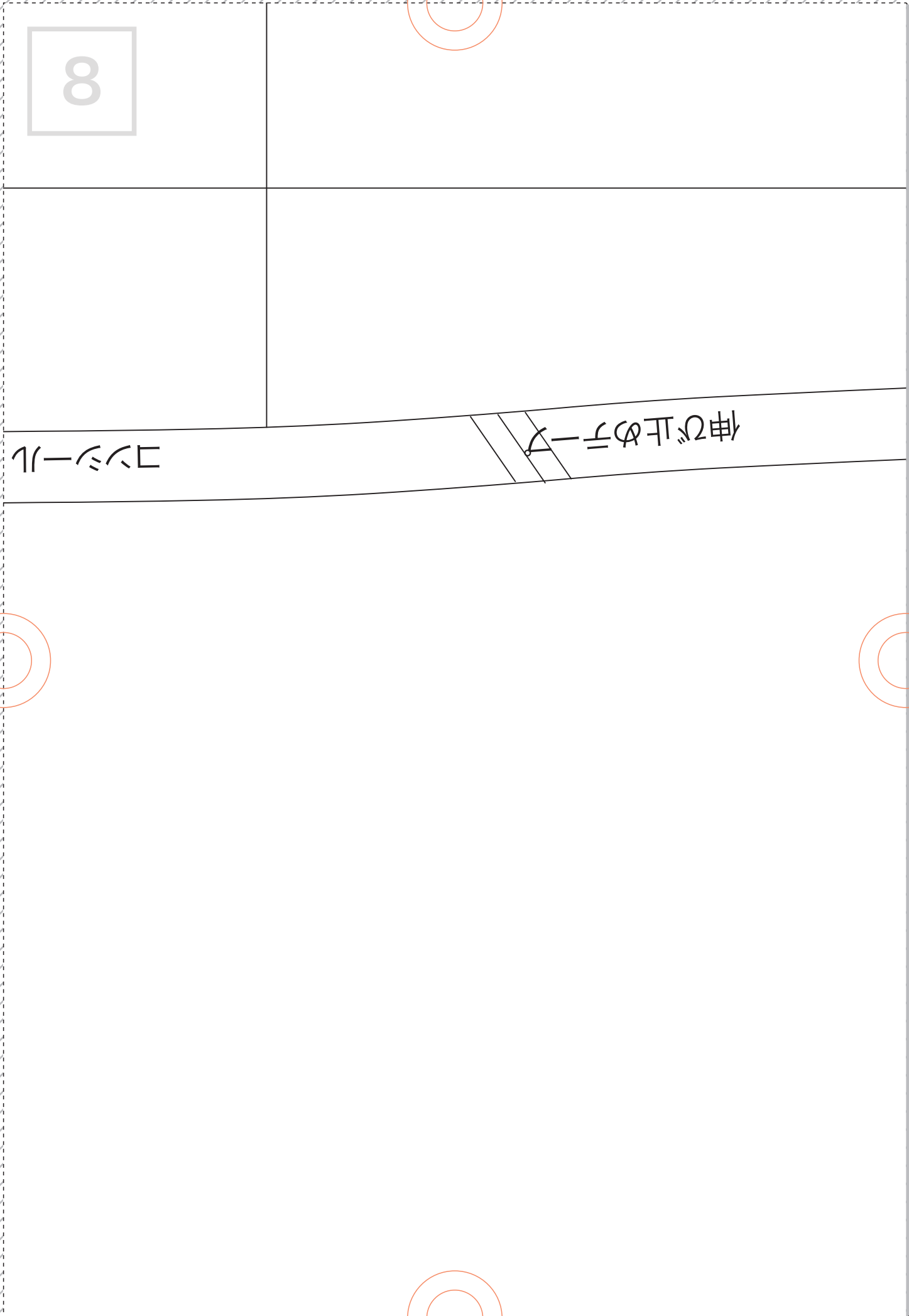

9

地目〇

10

▽ ファスナー開き止まり

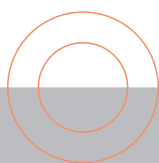
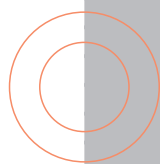
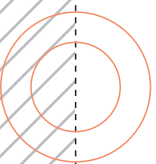
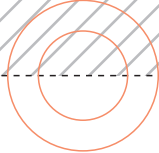

11

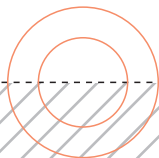
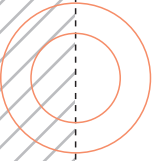
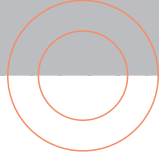

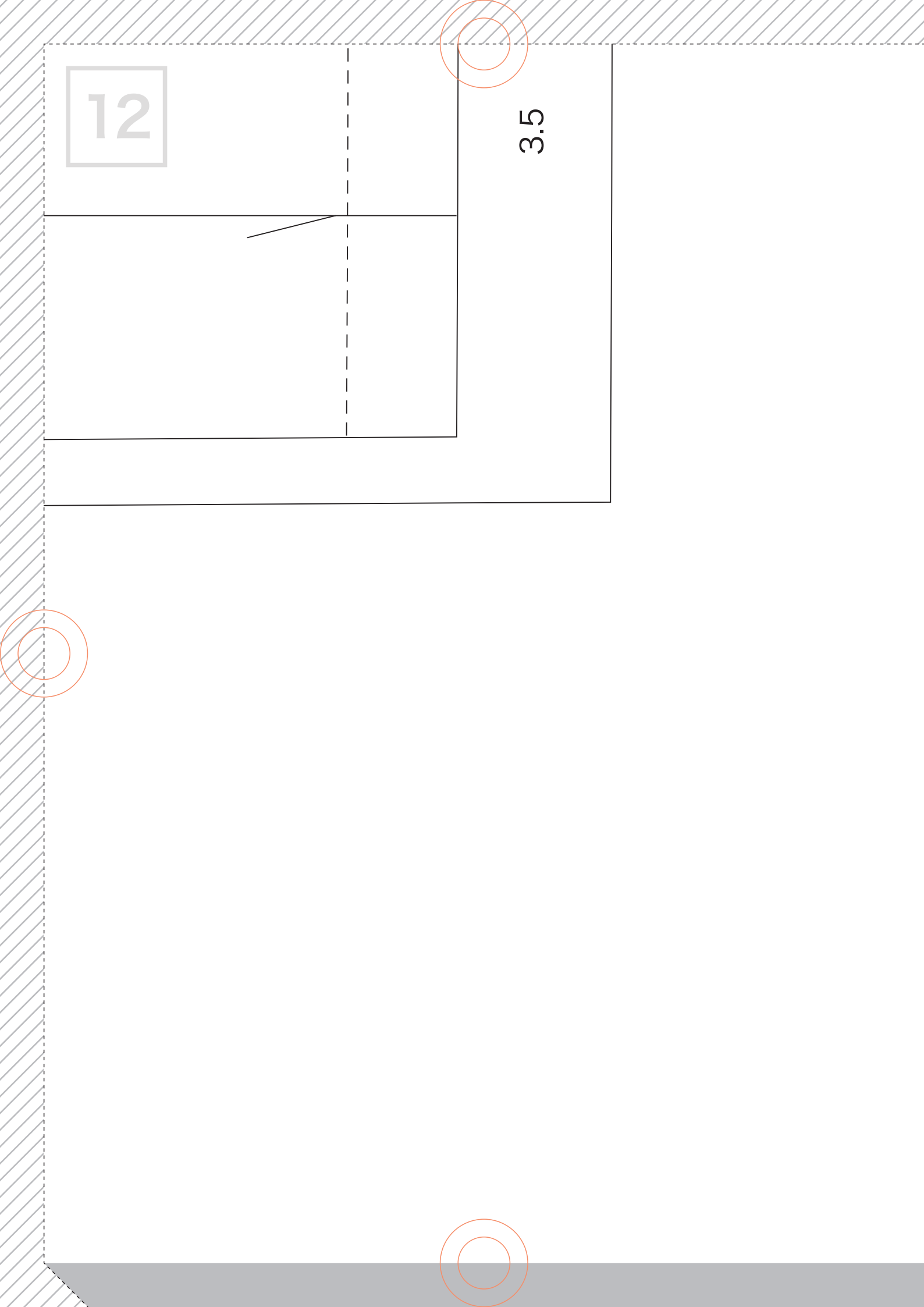

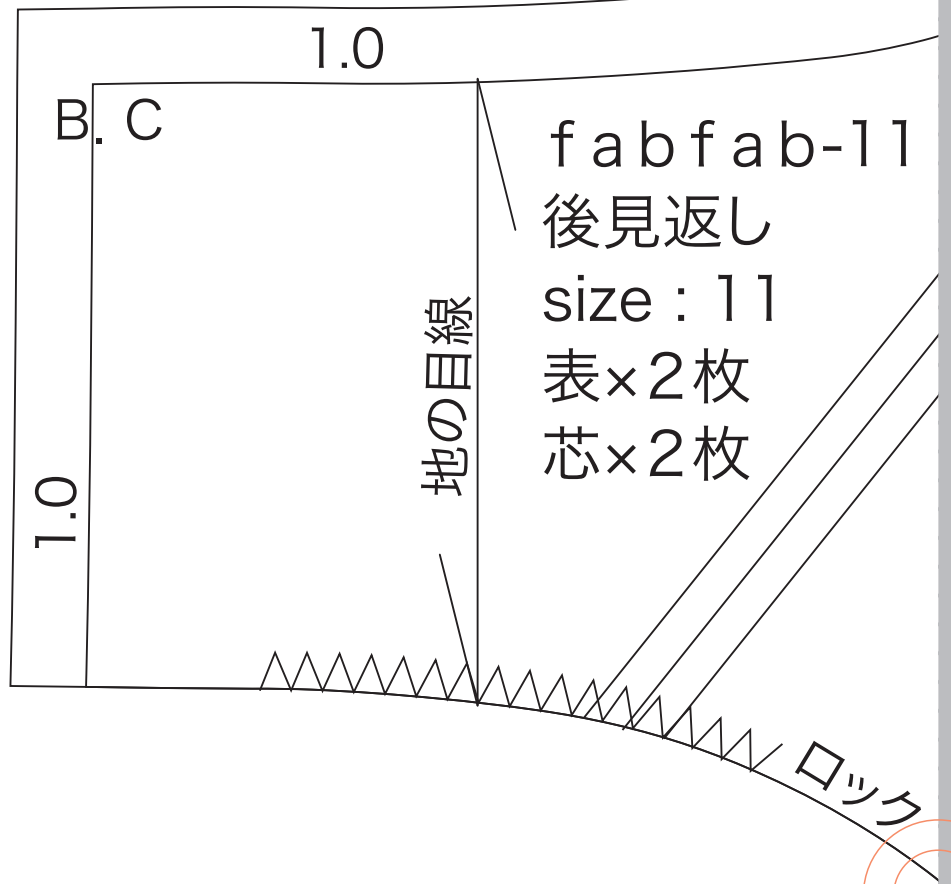

14

1.0

全面芯はり

1.0

脇

1.0

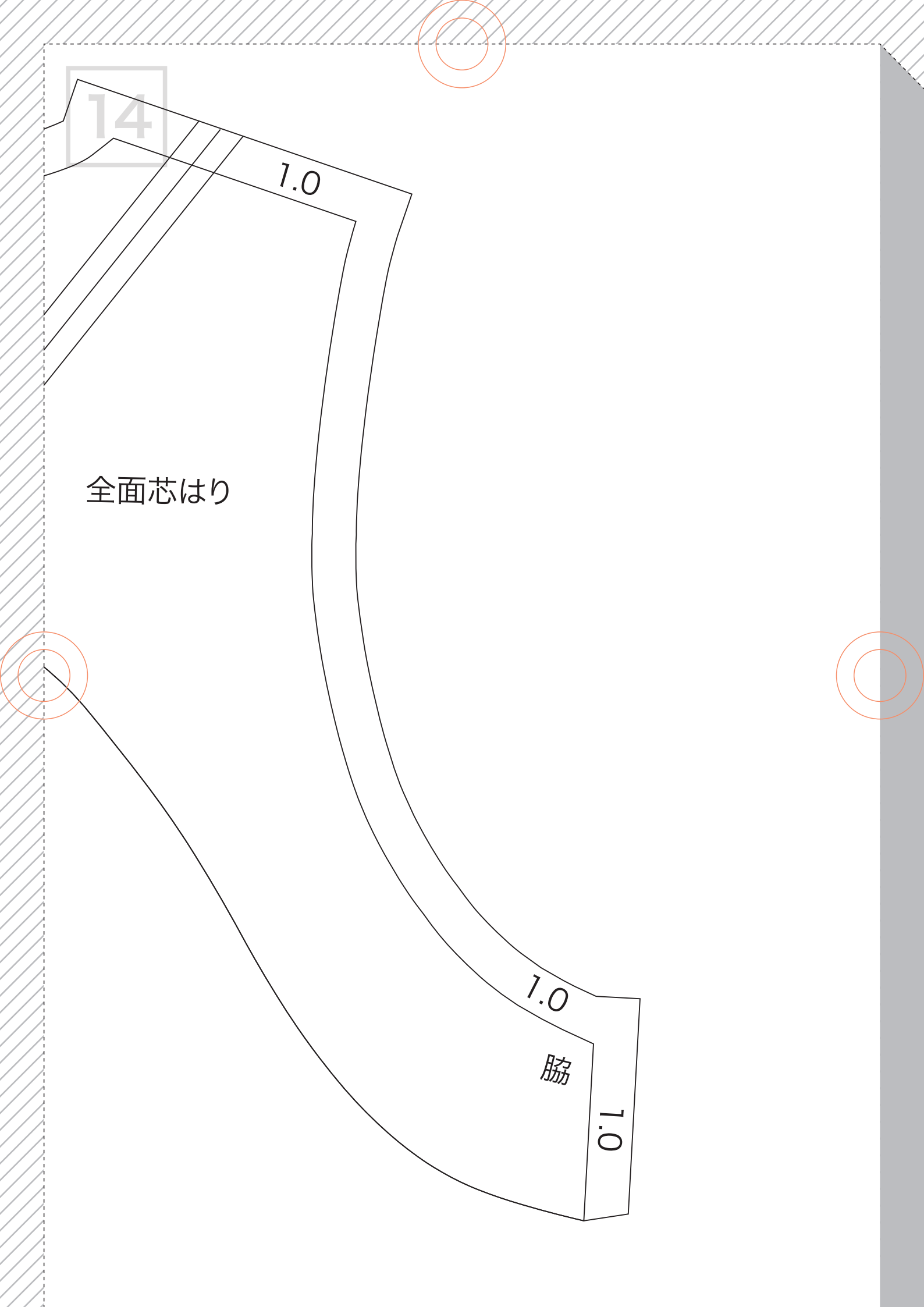

15

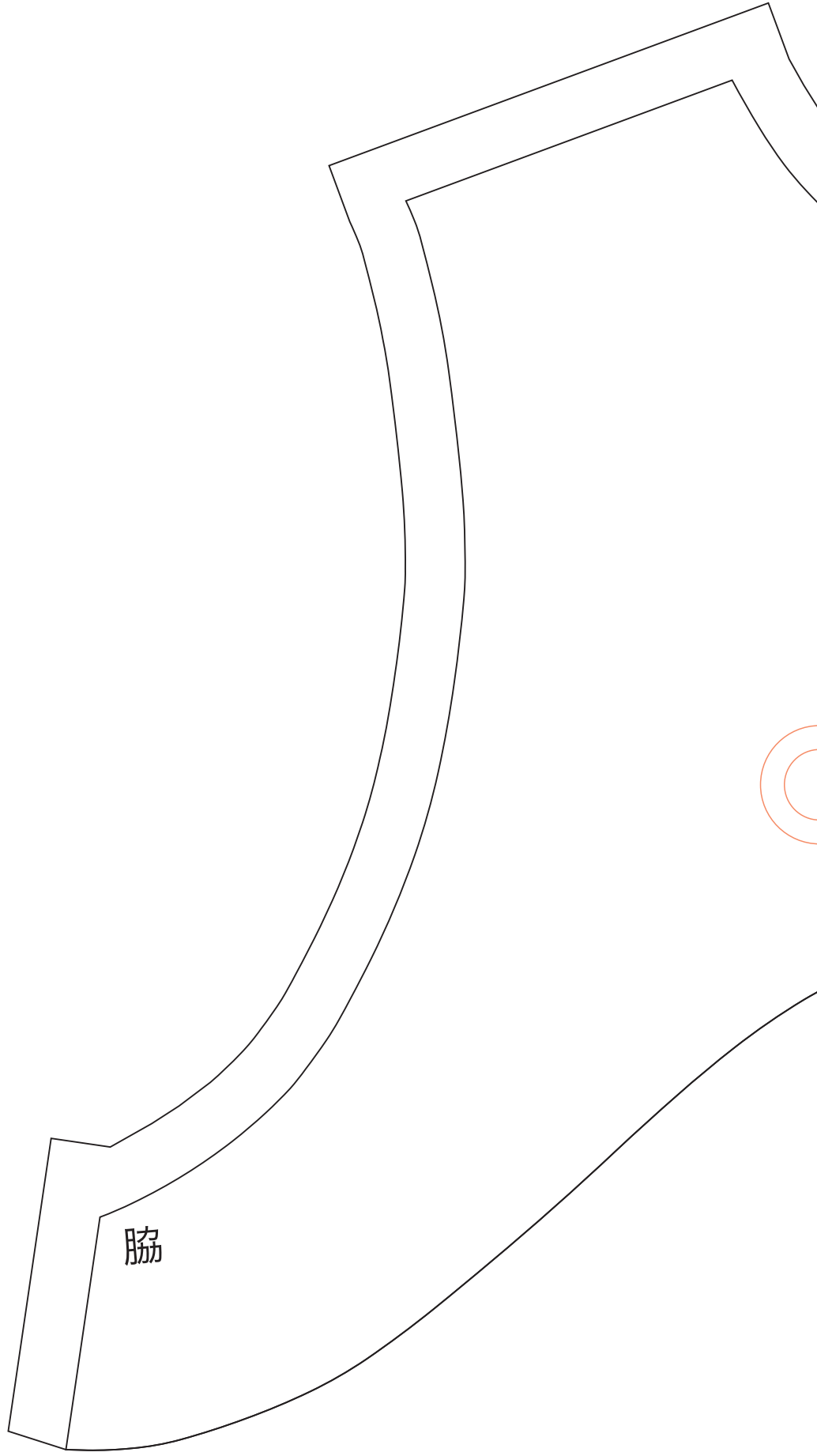

脇

16

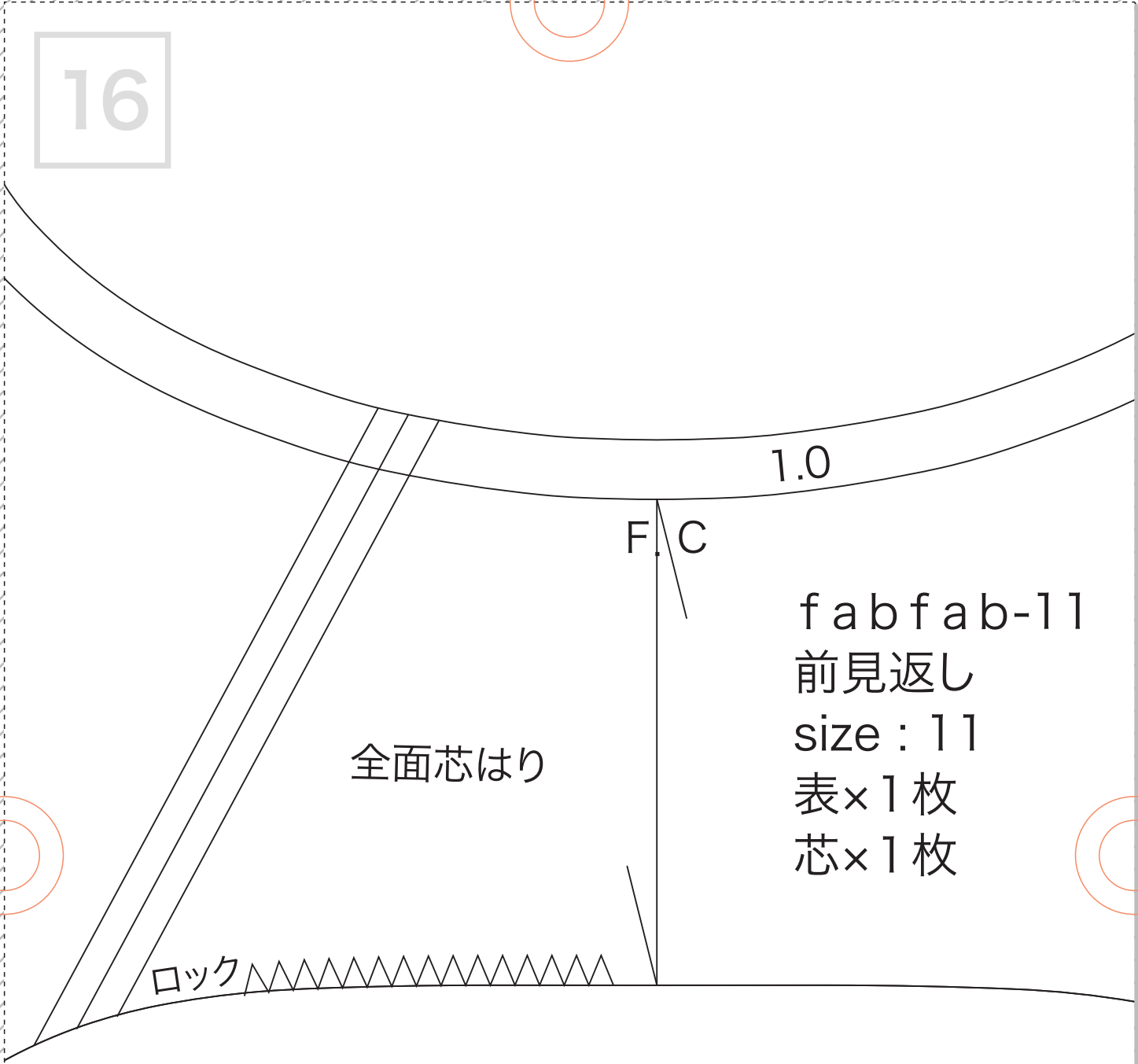

全面芯はり

fabfab-11
前見返し
size : 11
表×1枚
芯×1枚

ロック

17

1.0

1.0

脇

1.0

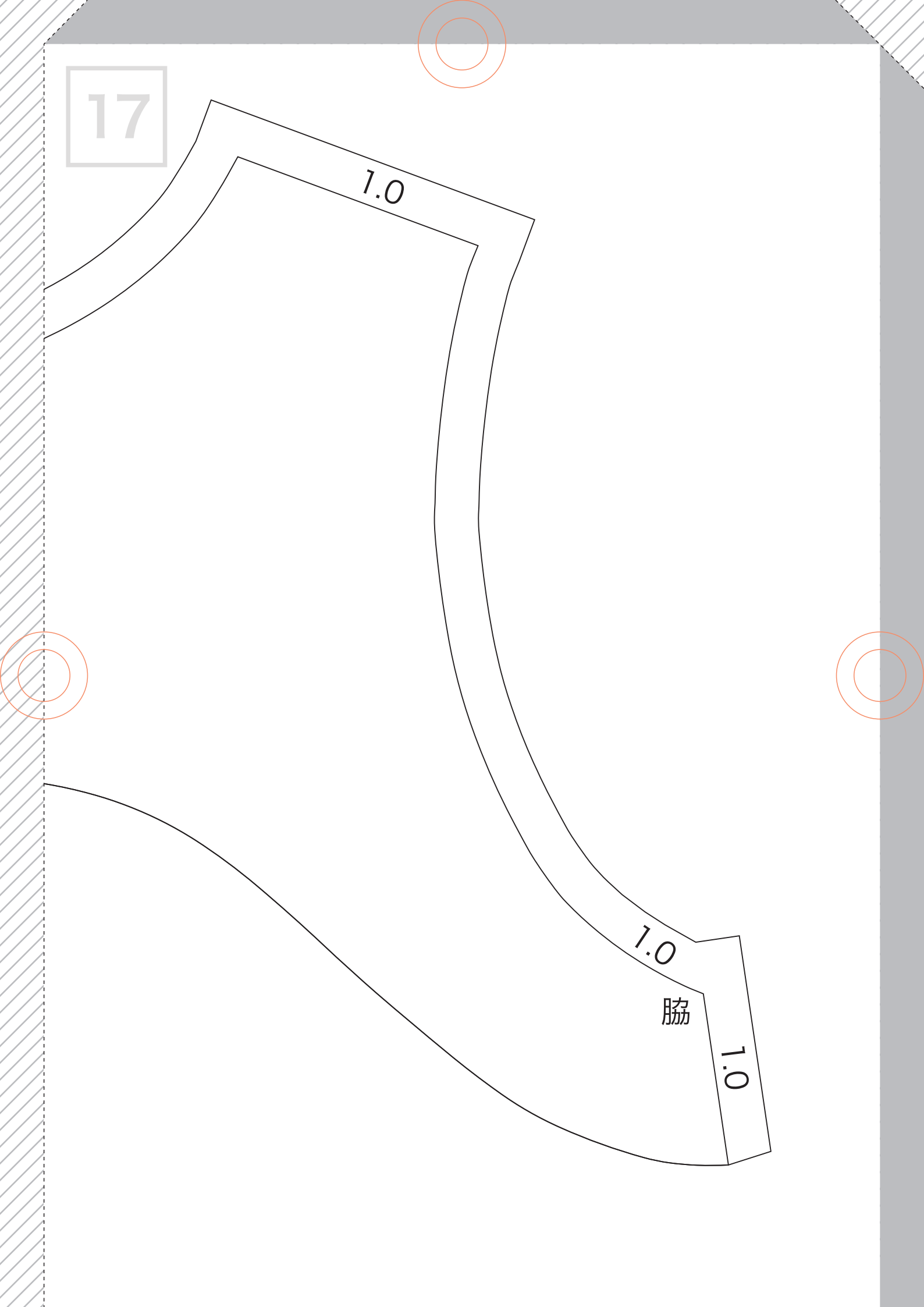

18

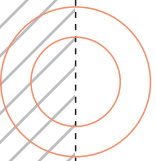
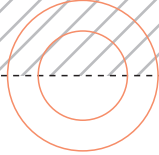

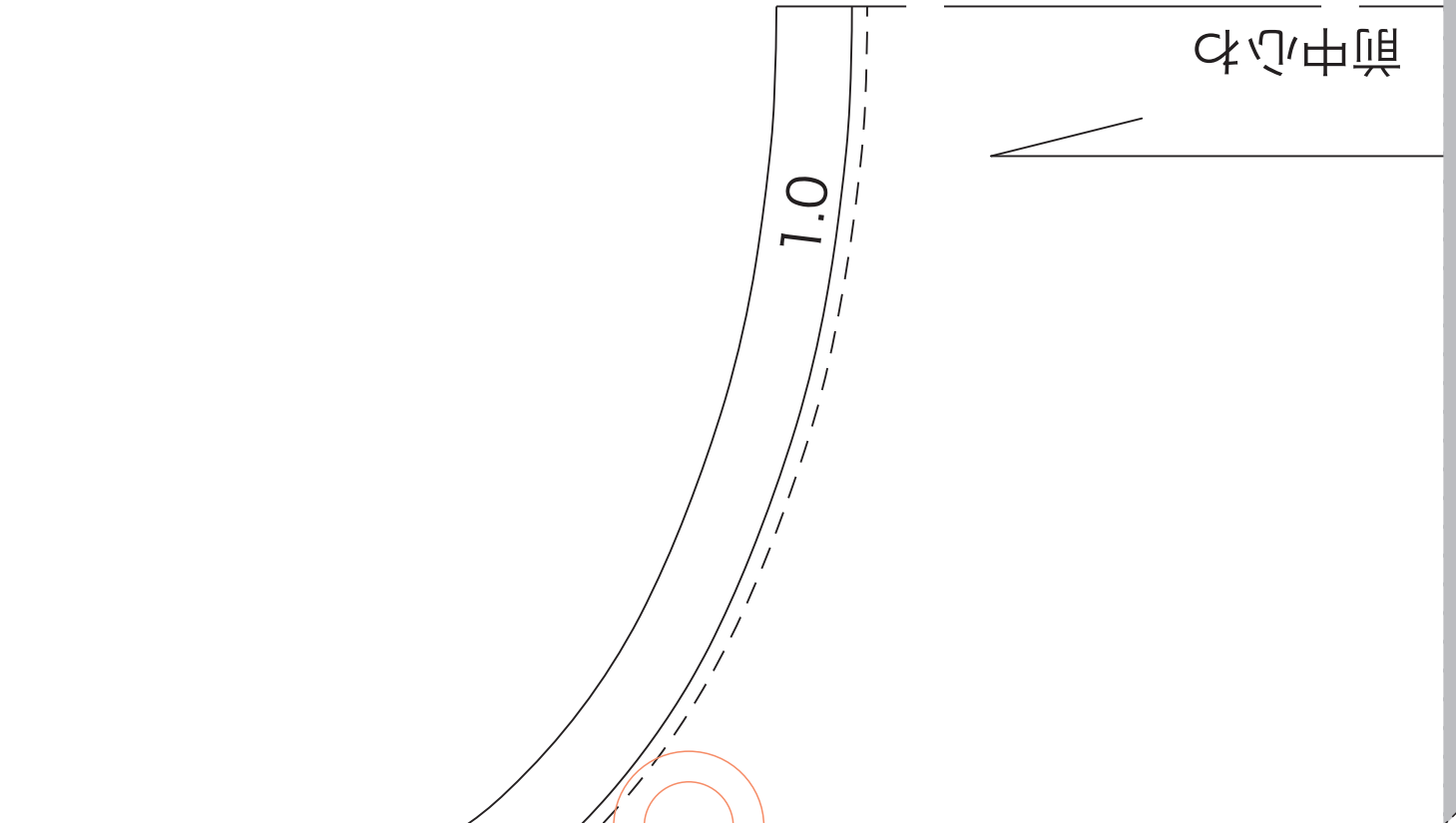

切り取る (斜線部はカット)

20

fabfab-11

前身頃

size: 11

表×1枚

21

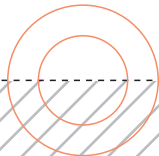
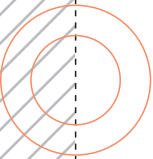

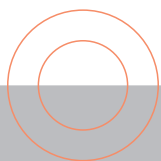
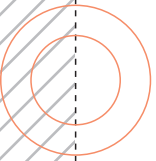

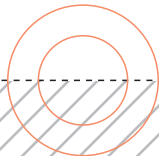
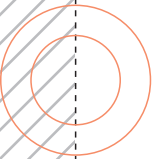

24

2.5cm幅三つ折りステッチ

3.5

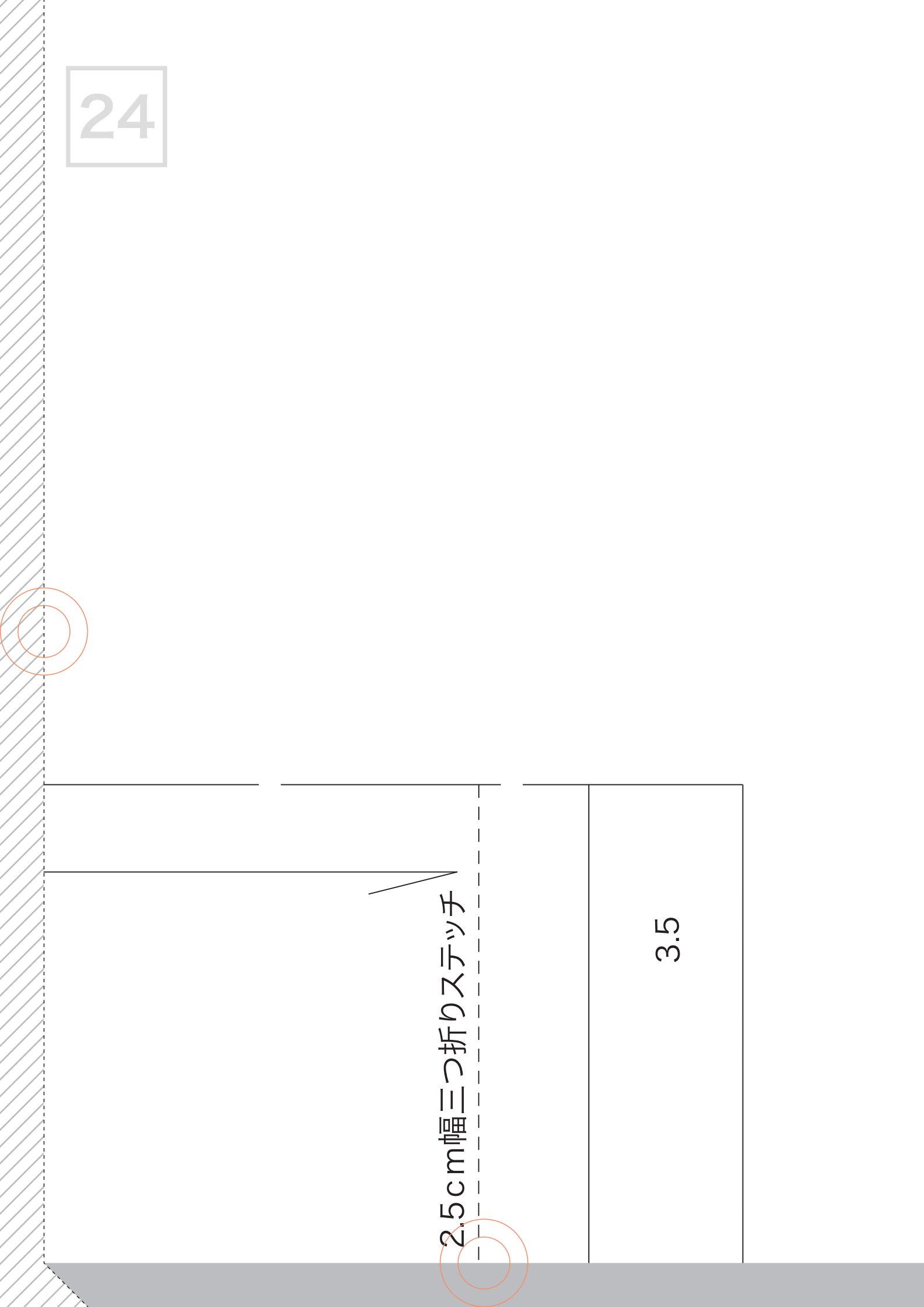

25

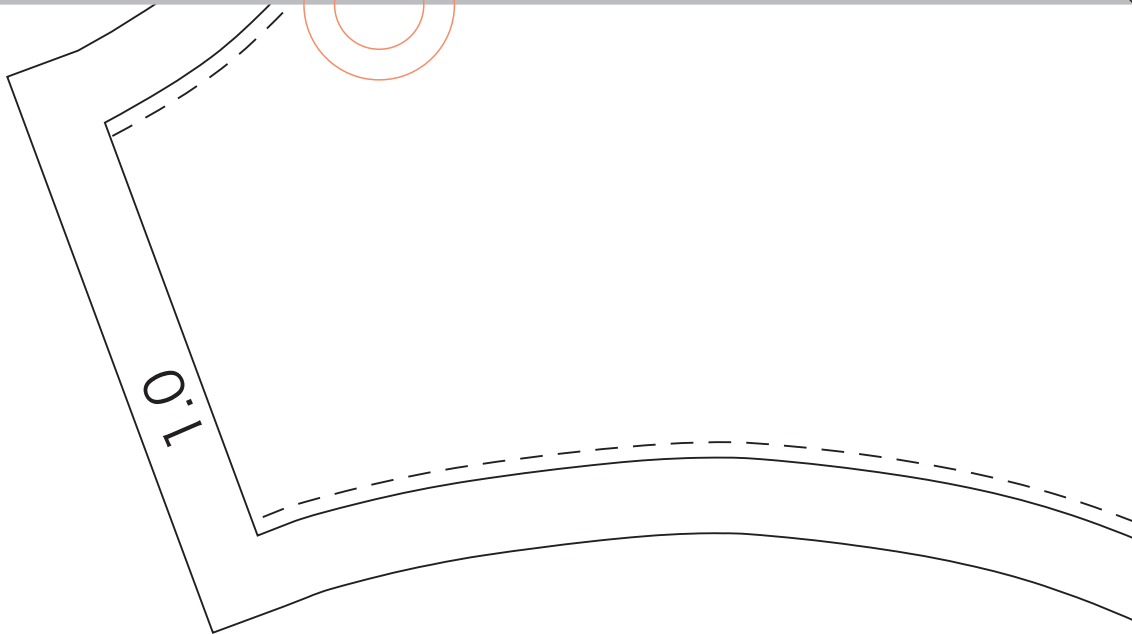

26

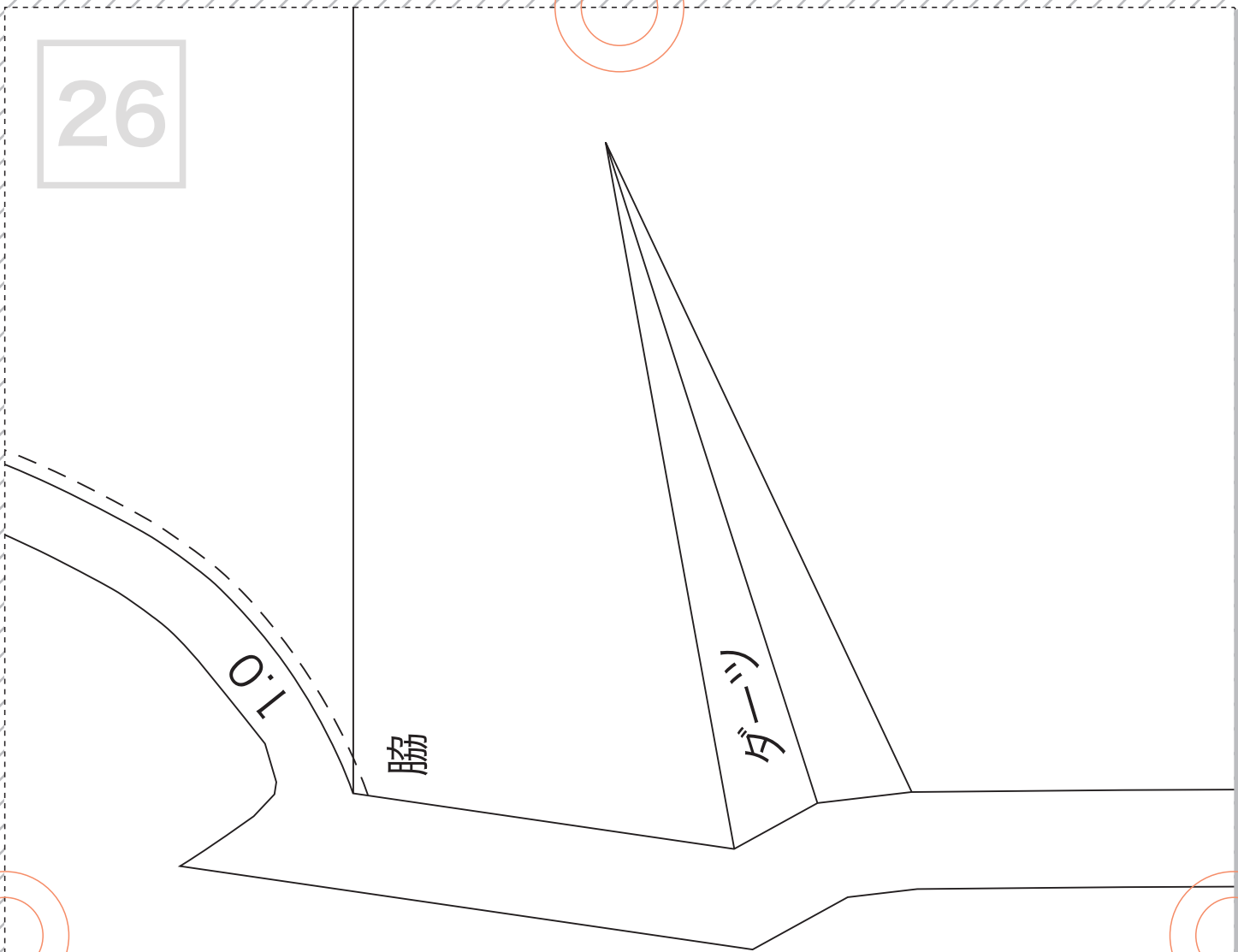

10:1

脇

ダーク

27

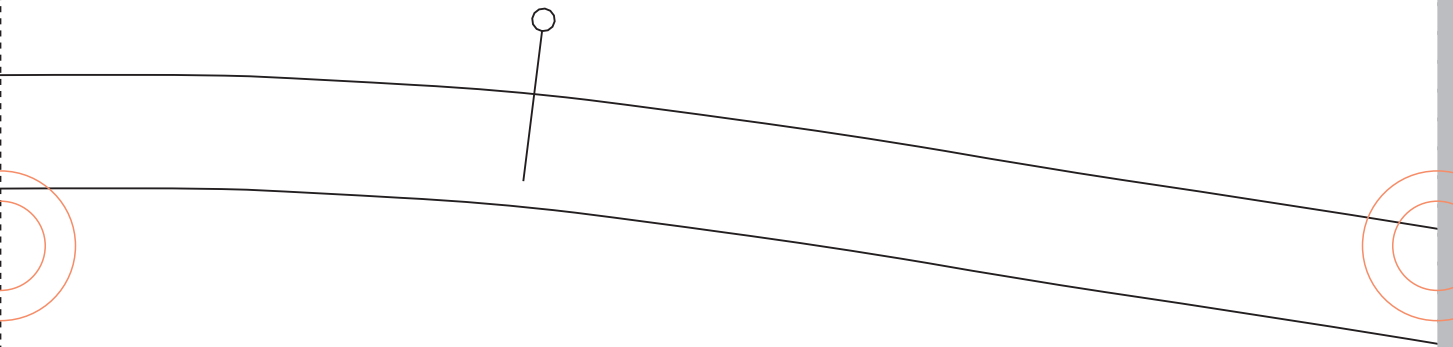
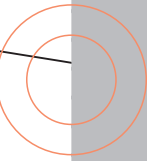
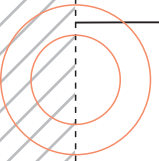
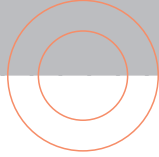

28

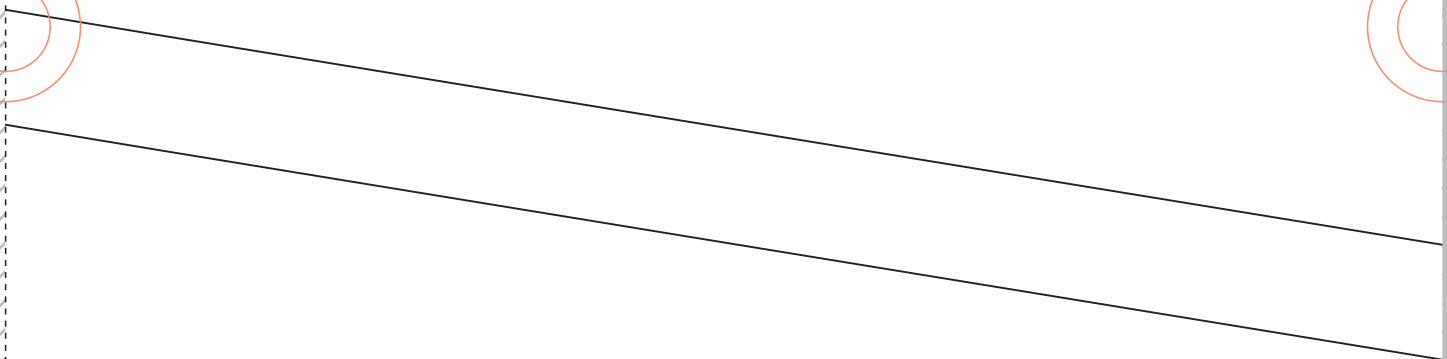
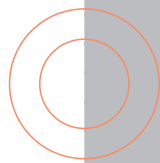
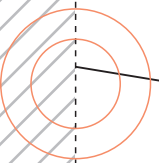
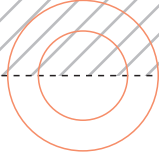

29

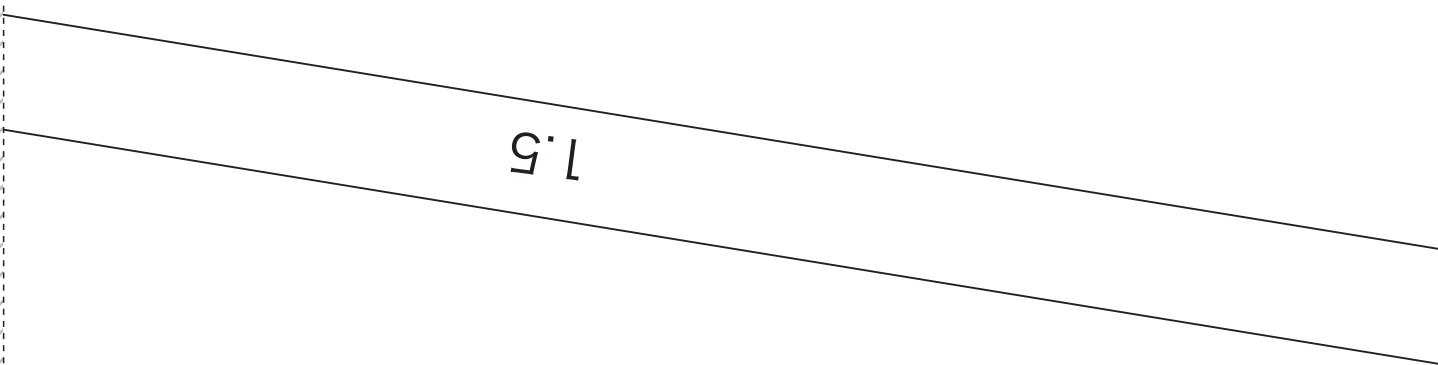
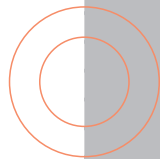
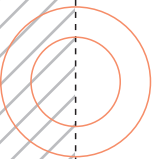
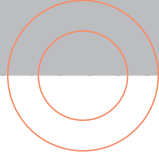

30

裾出来上がり線

