

introduction はじめに

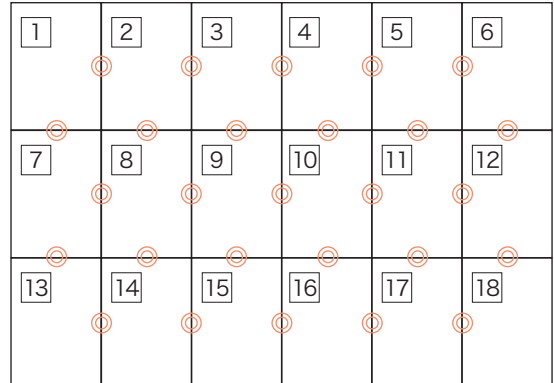

パターンは A4 サイズ 27 枚に分割されています。
印刷後、右図のようにつなぎ合わせてください。

! 印刷時の注意

印刷設定では、「ページの拡大や縮小」を選択せず
必ず、「実際のサイズ」(原寸)で印刷してください。



how to make パターンのつくりかた

STEP1 斜線部分  は切り取り、灰色部分  は残してのりしろにします。
(斜線と灰色を間違えないように注意)

STEP2 各用紙の番号を確認し、 の位置を合わせて、
のりづけします。
(水のりは用紙が波打ちます。スティック糊などをお使いください)

STEP3 それぞれのパーツをハサミで切り出します。

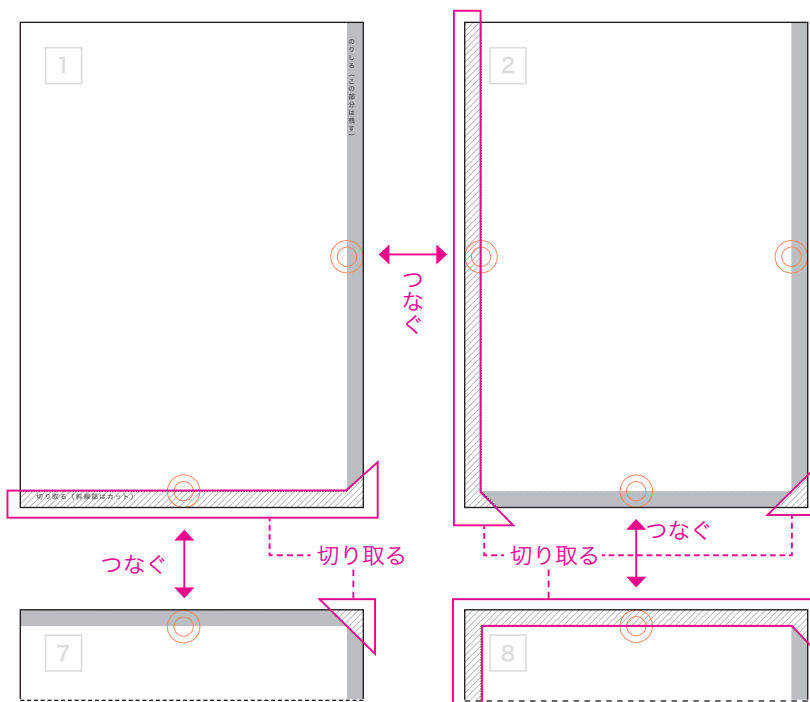
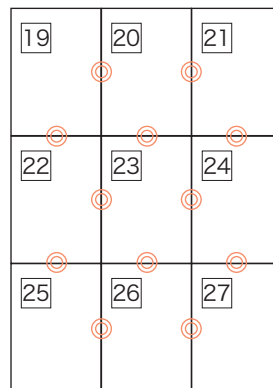

1

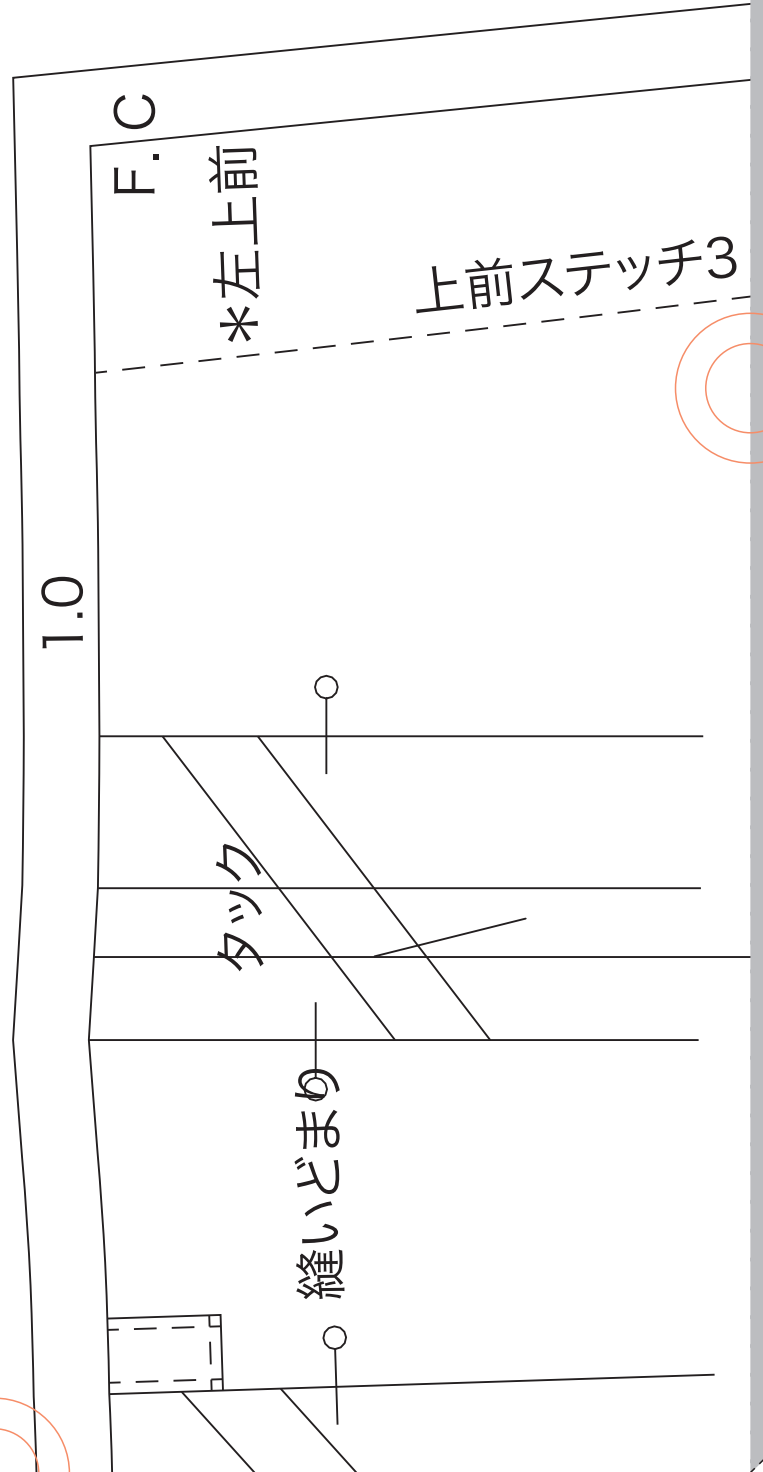

切り取る (斜線部はカット)

2

1.0

cm

ファスナー開きどきり

タックの方向

fabfab-12

前パンツ

size: 11

表×2枚

3

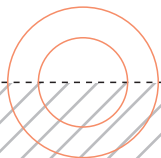
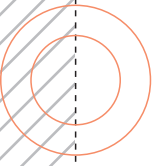

4

地目線

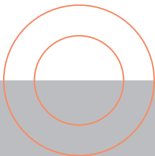
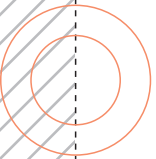

5

1.0

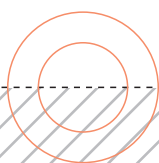
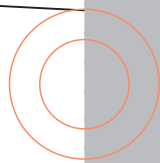
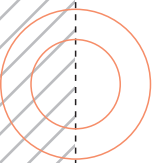

6

2cm幅三つ折りステッチ

3.0

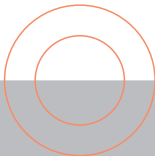
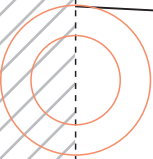

7

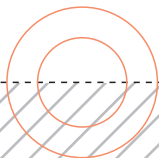
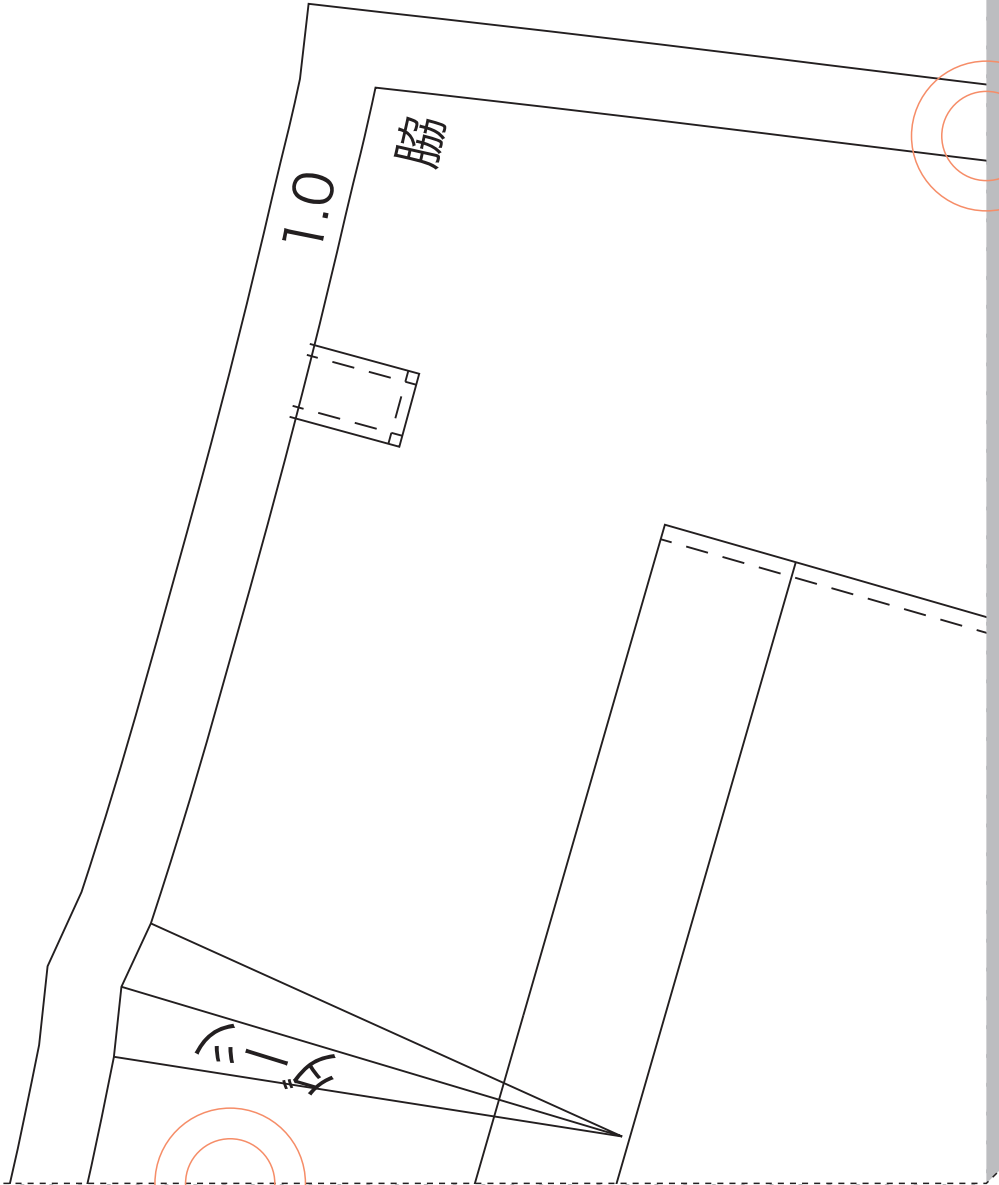
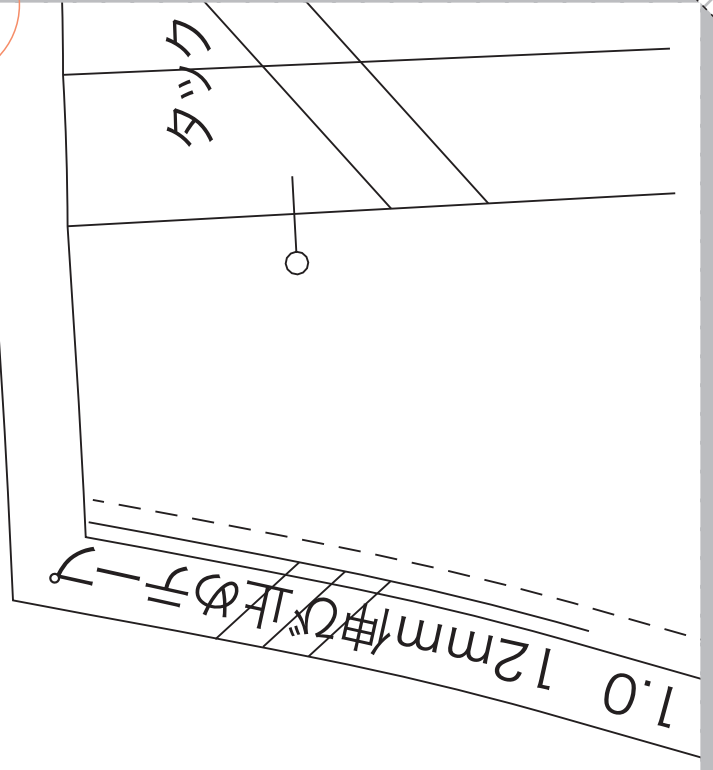

8

脇

ポケット口

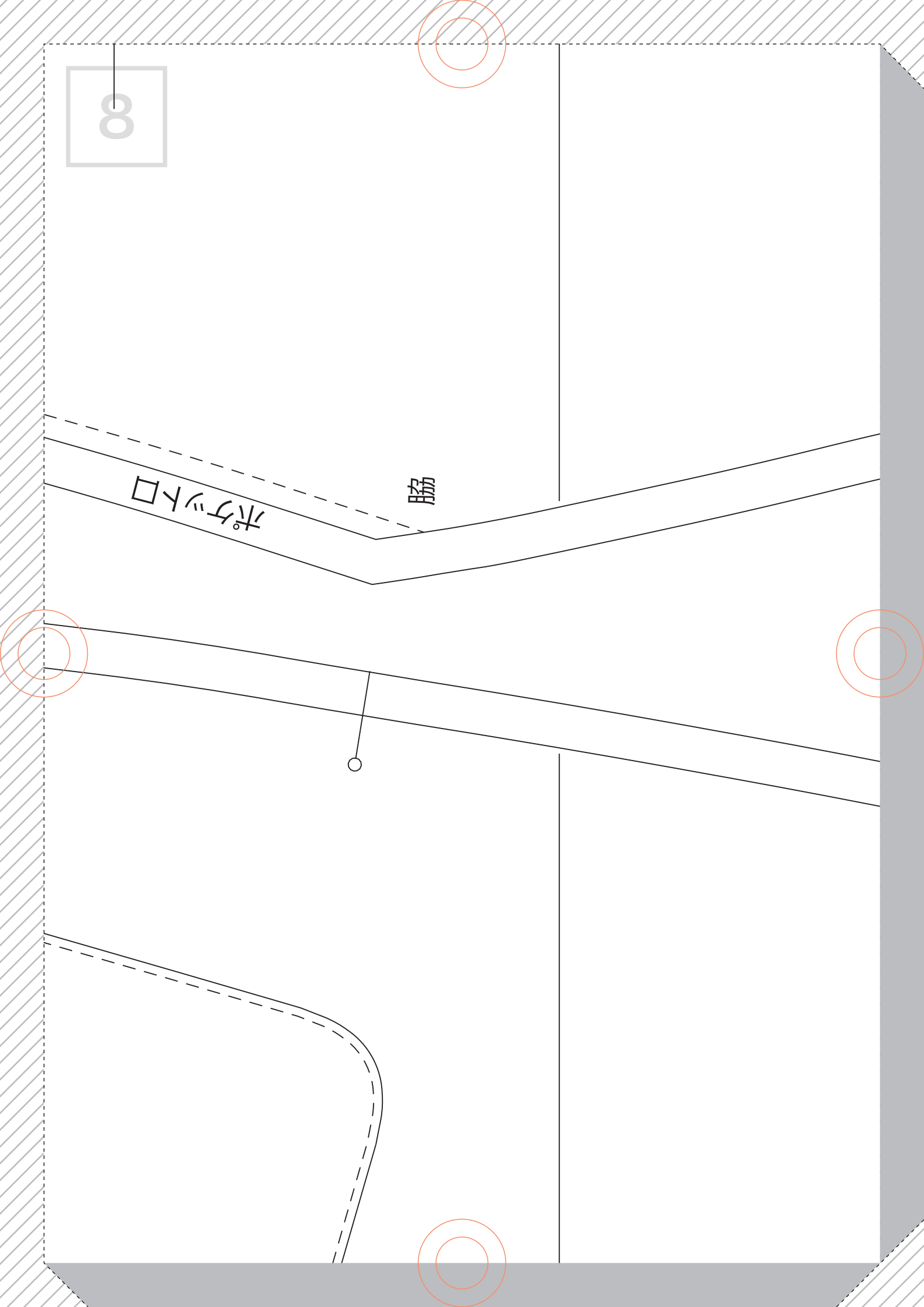

9

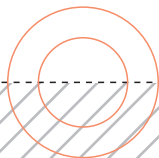
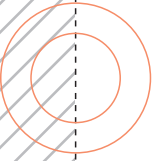
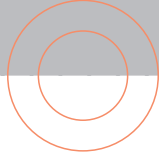

10

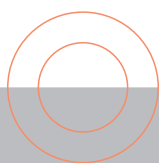
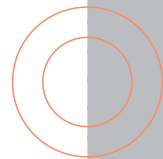
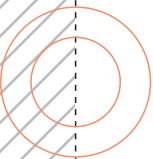
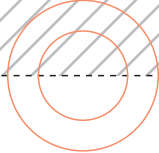

ロック片倒し(後高)

11

0.1

1.0

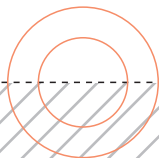
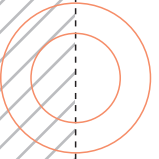
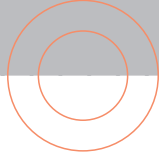

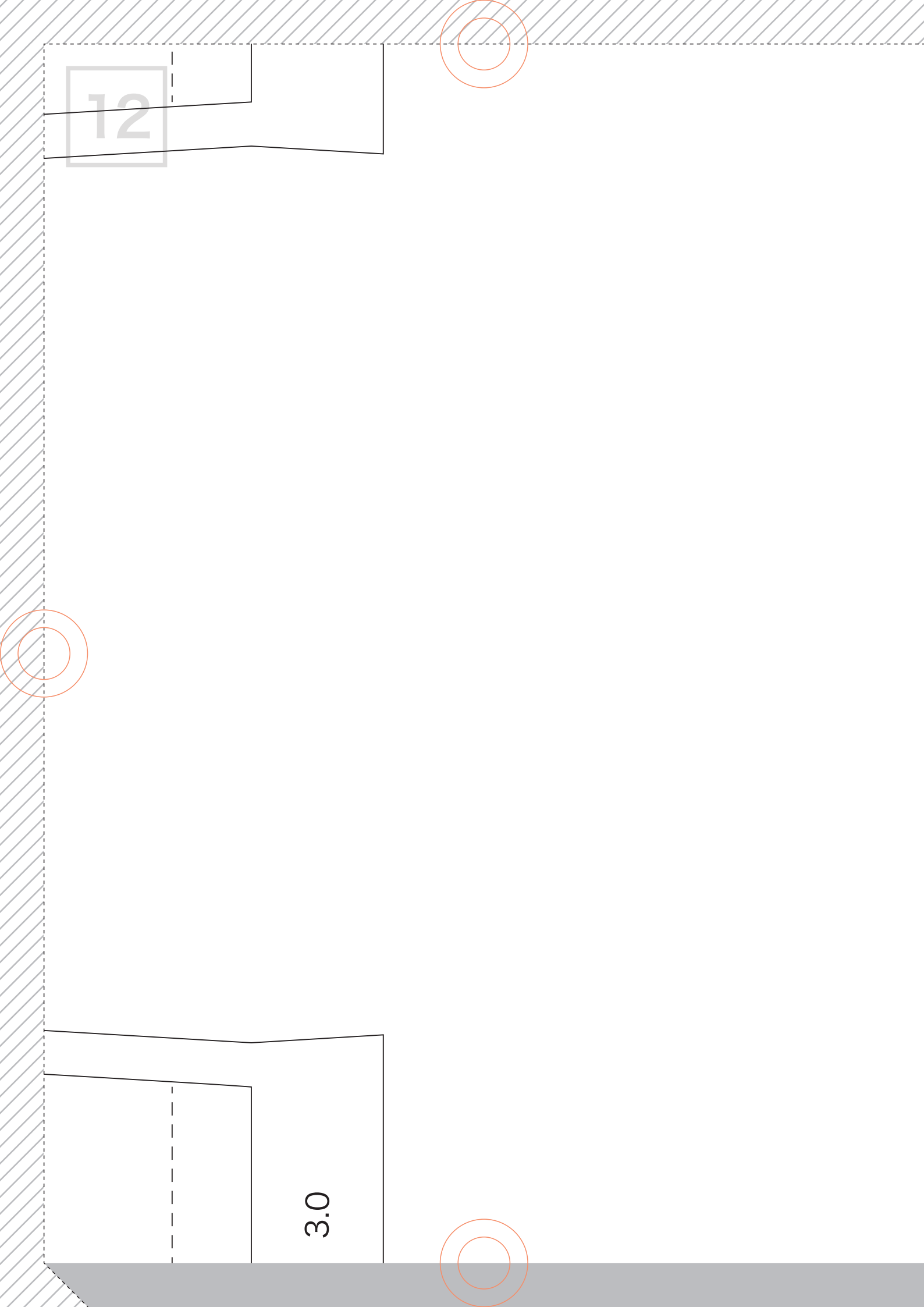

12

3.0

13

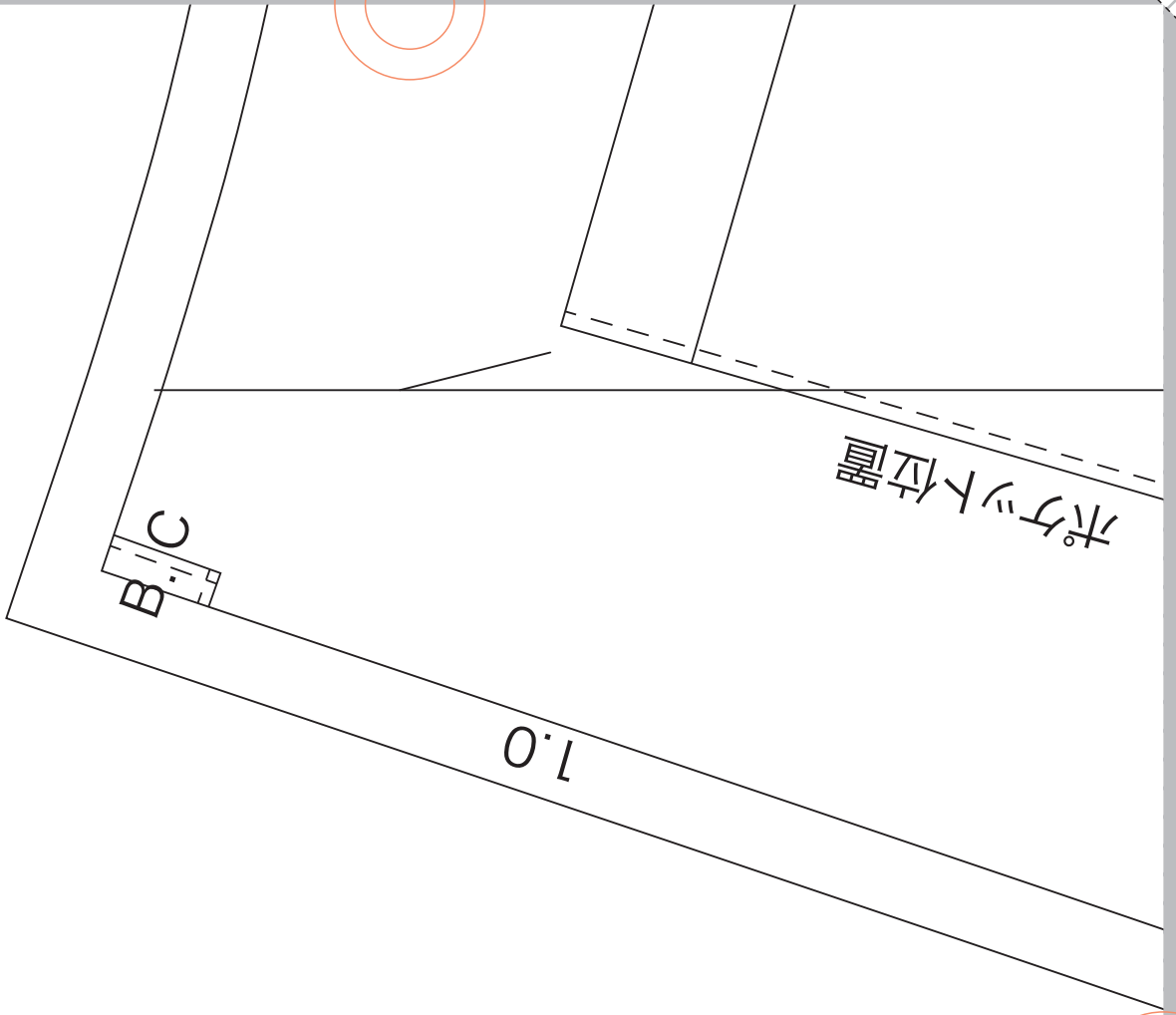

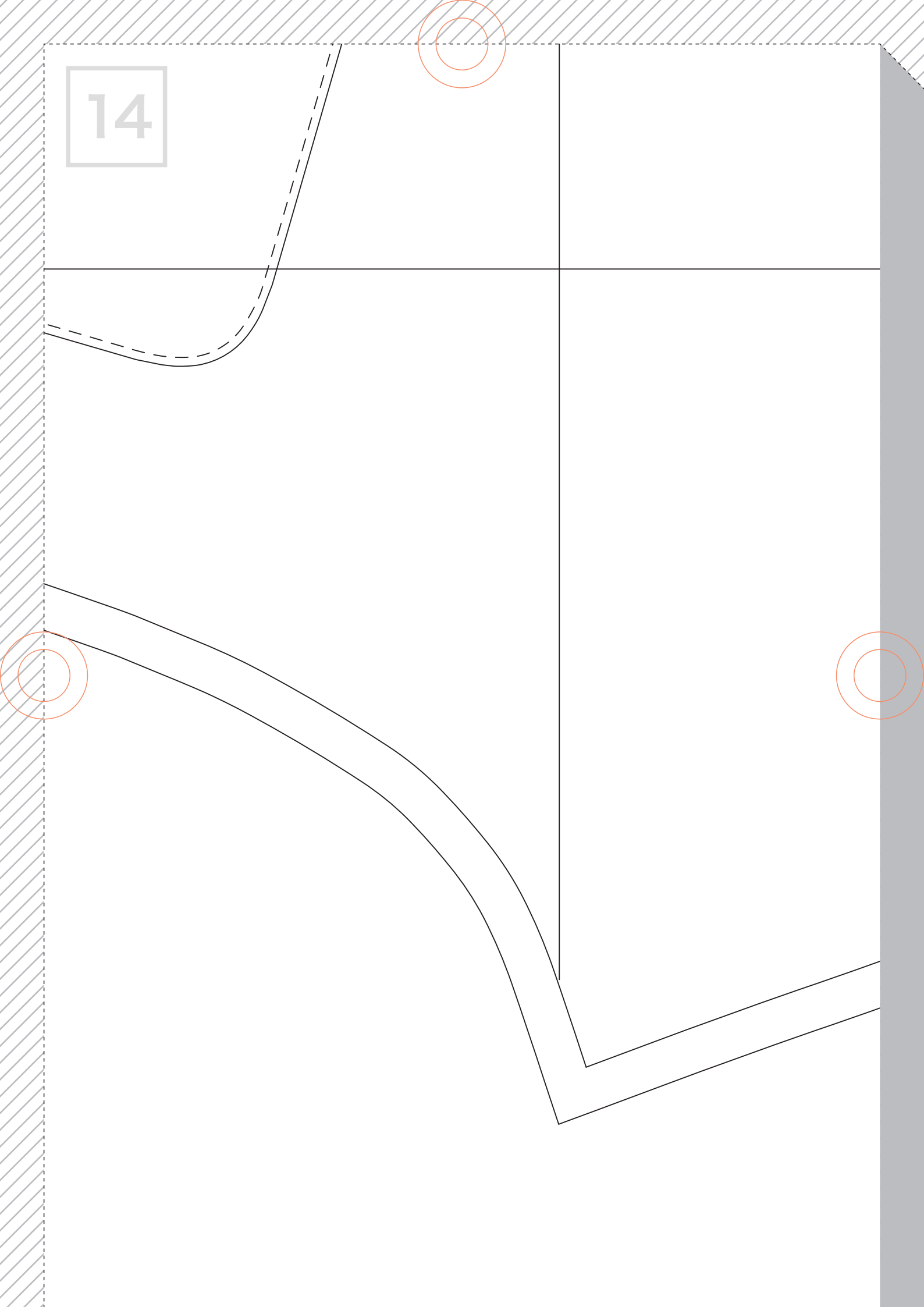

14

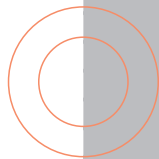
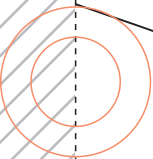
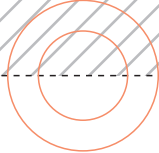

15

fabfab-12

後パンツ

size : 11

表×2枚

16

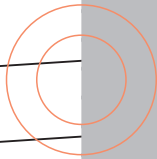
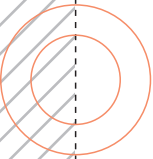
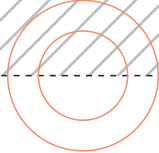

ロック片倒し(後高)

17

地の目線

0.1

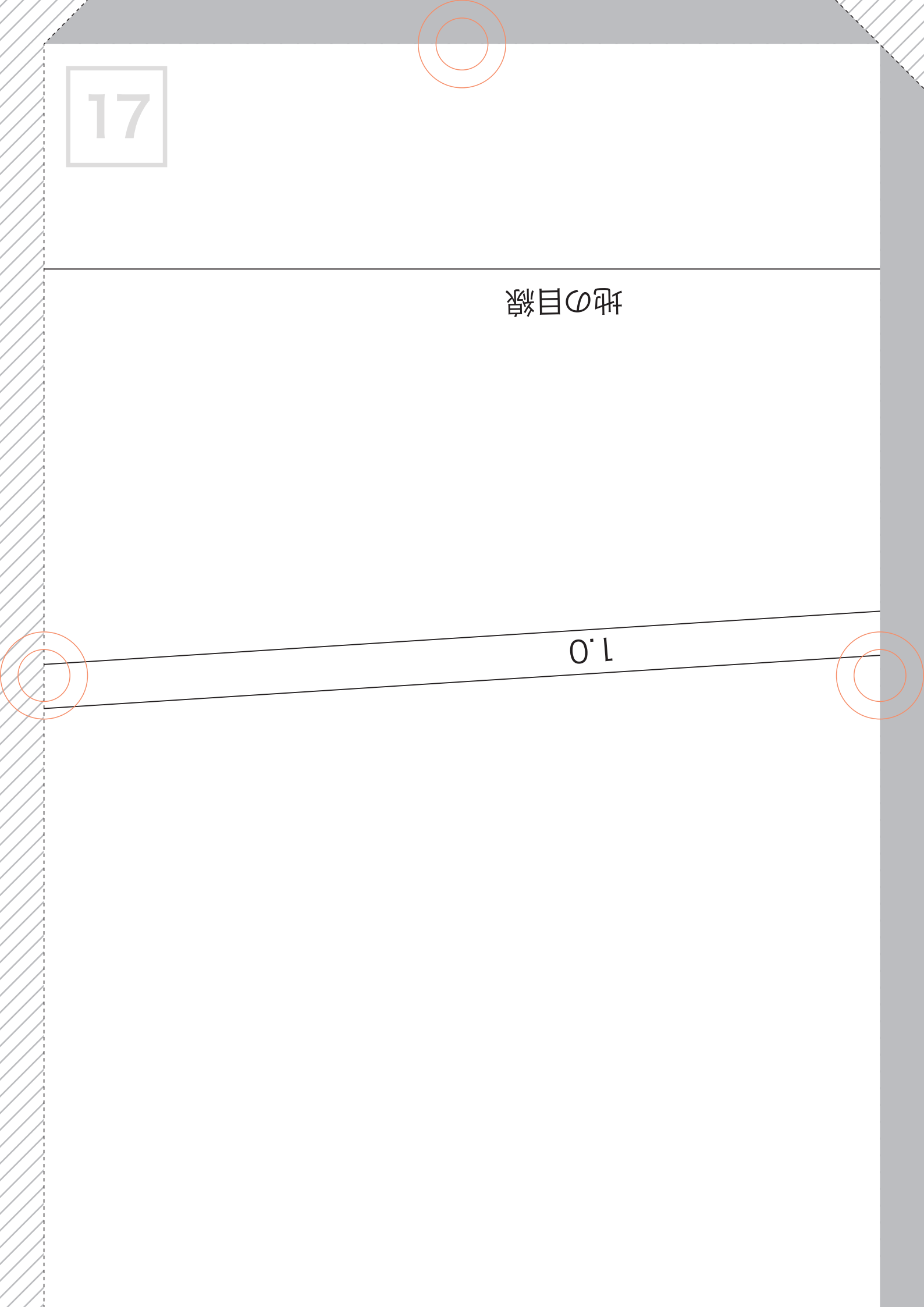

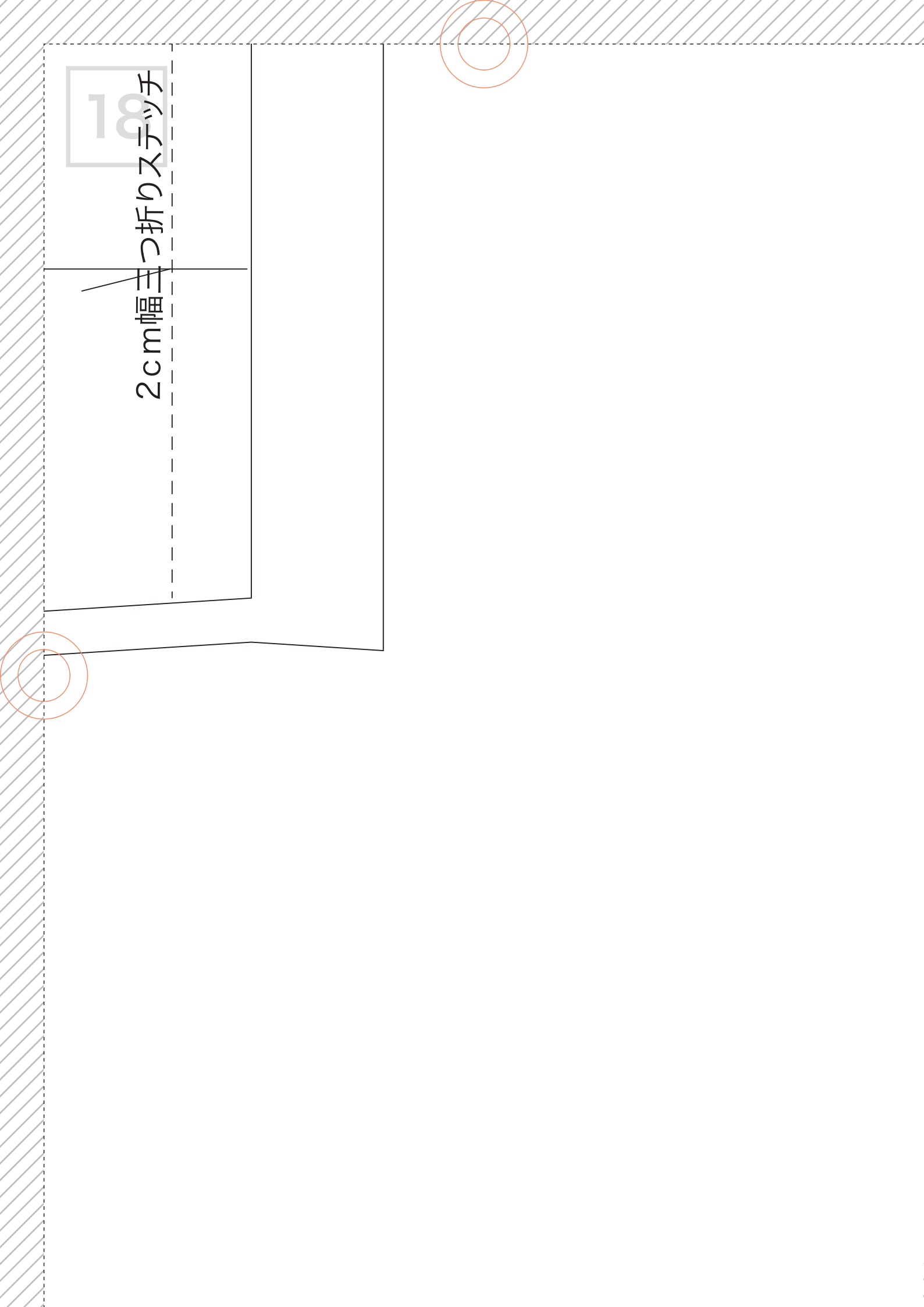

2cm幅の折りスリット

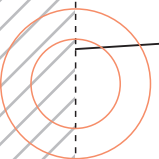
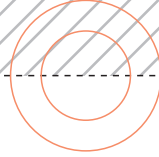

19

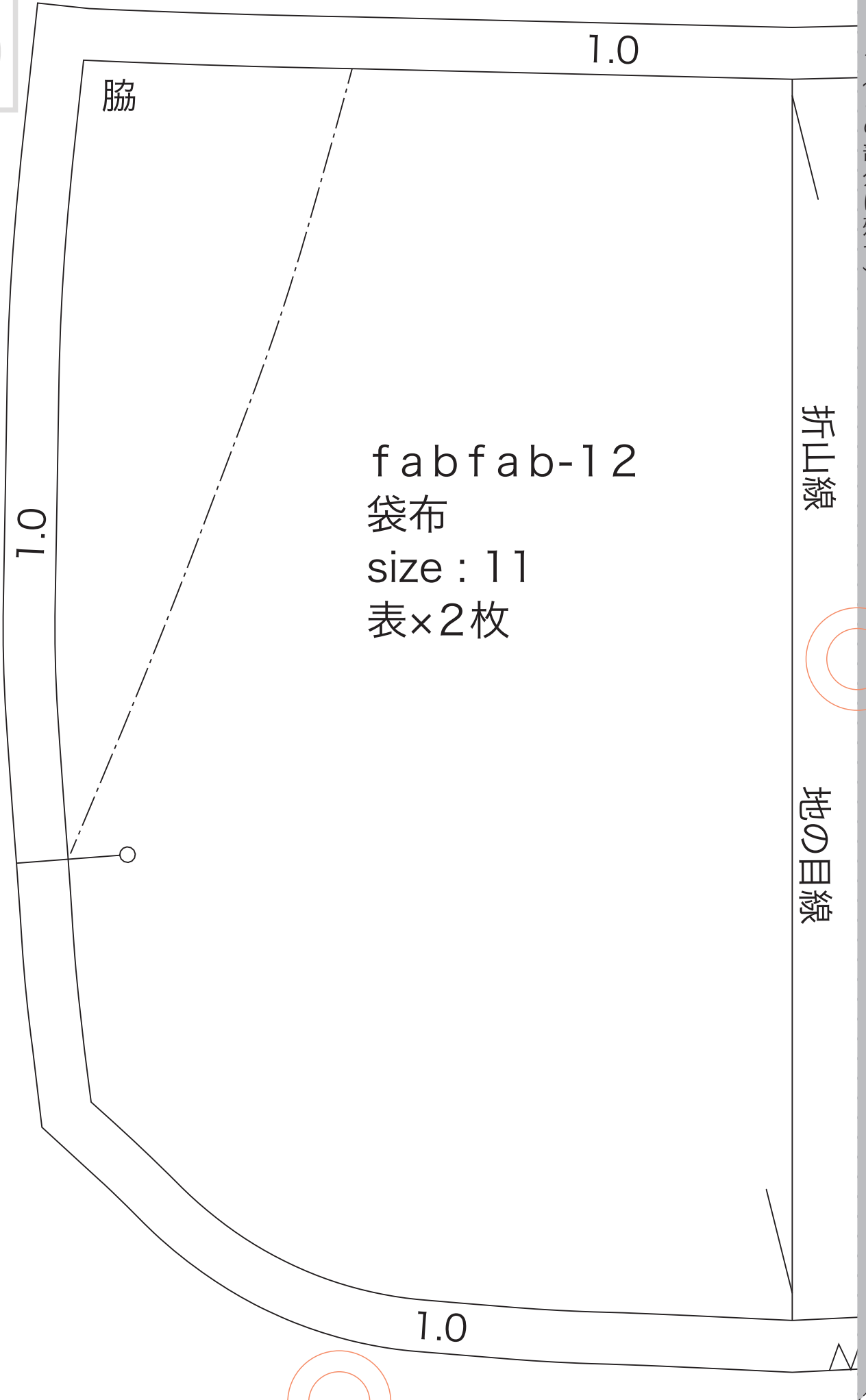

切り取る (斜線部はカット)

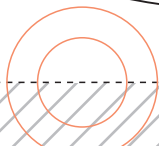

20

1.0

前パンツポケットロと接ビ

ロック

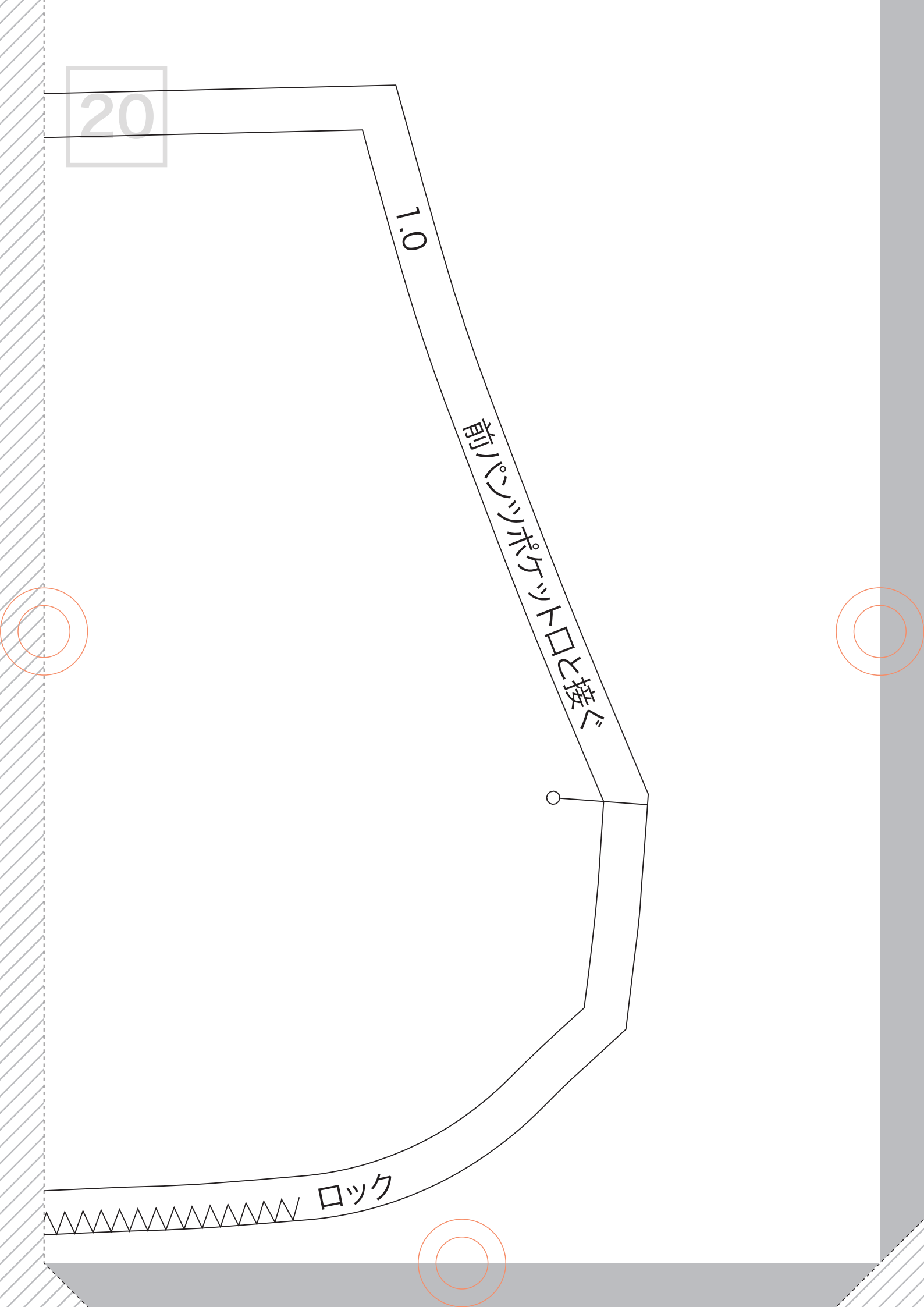

21

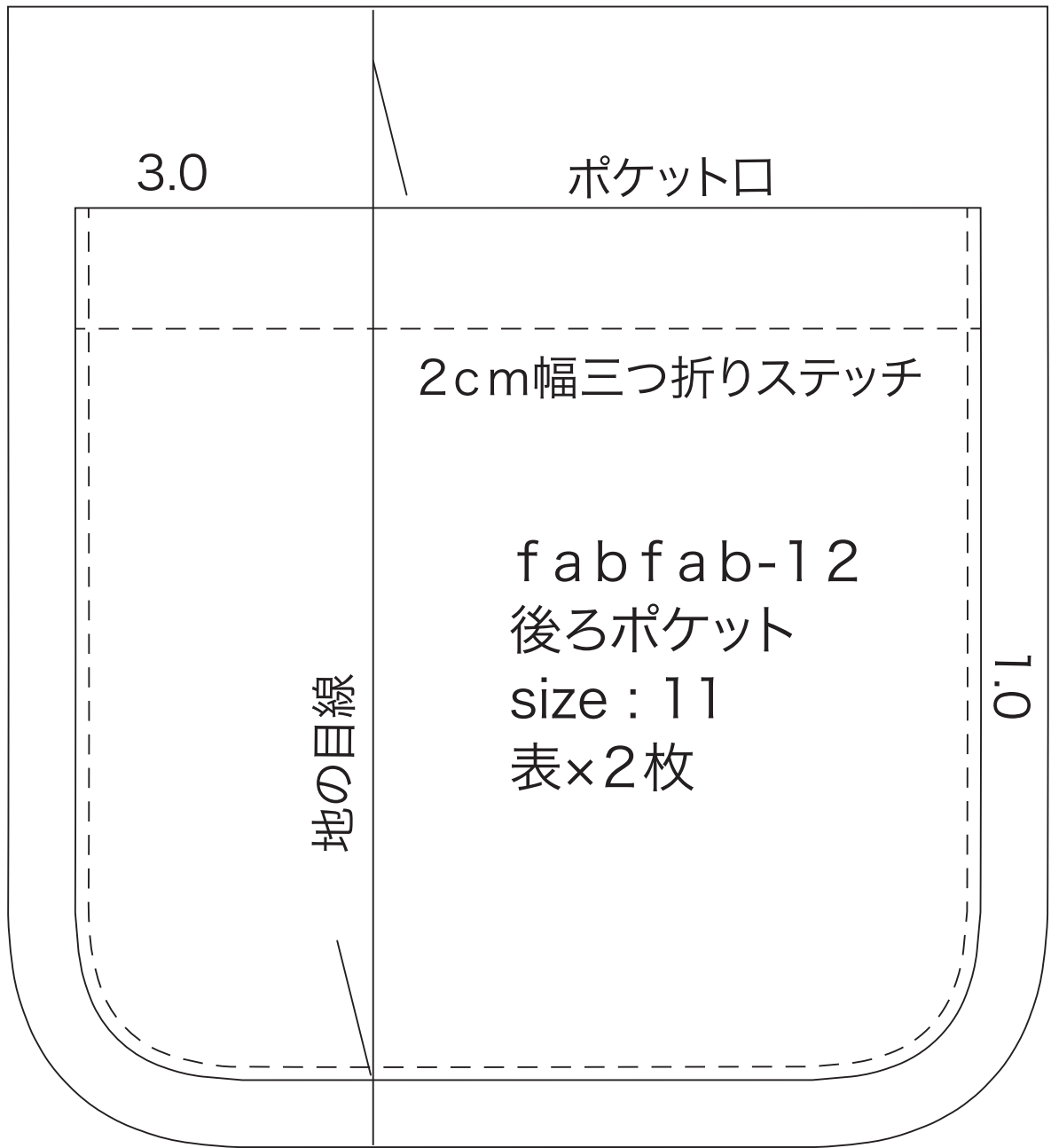

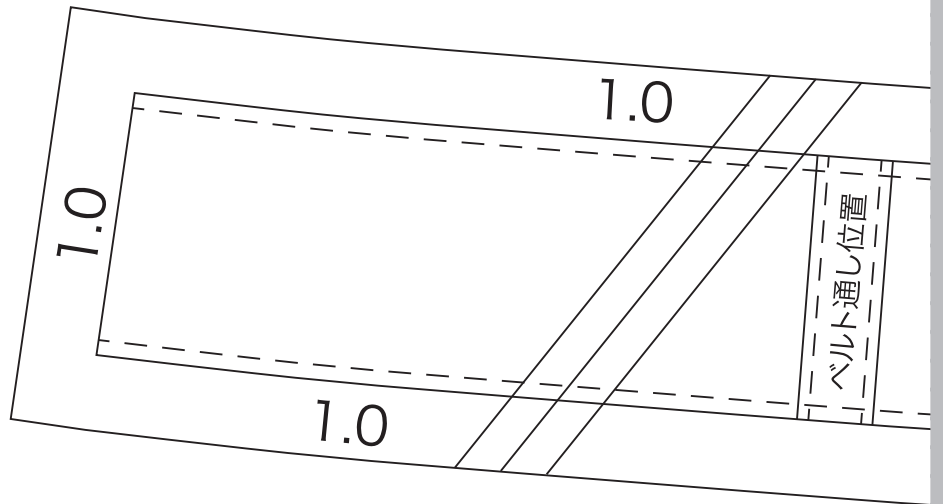
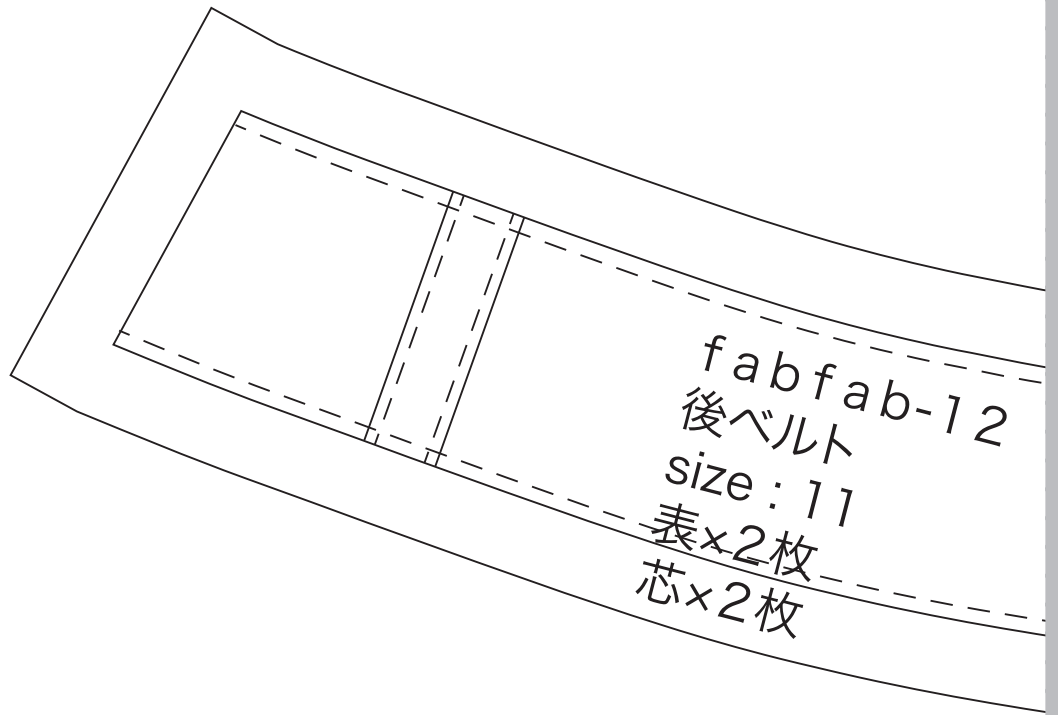

23

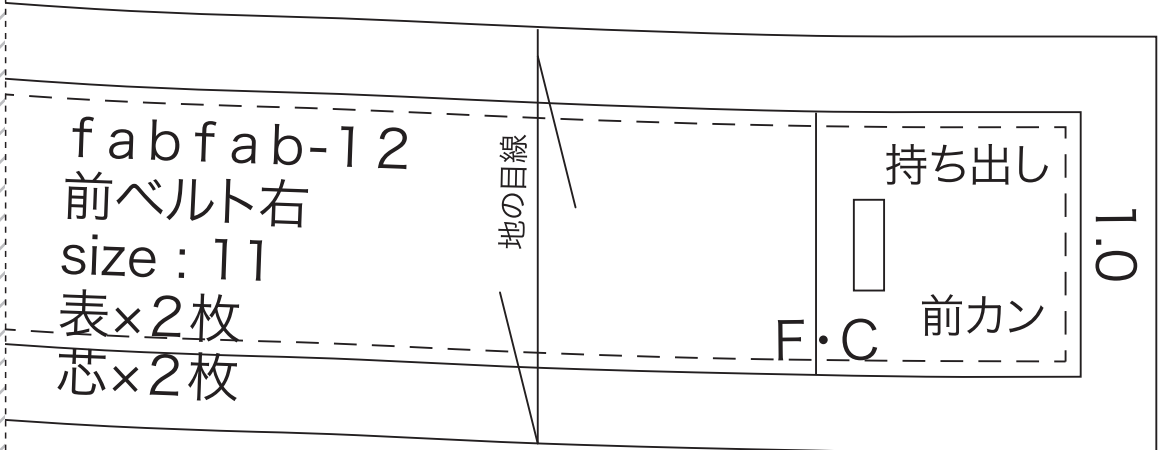
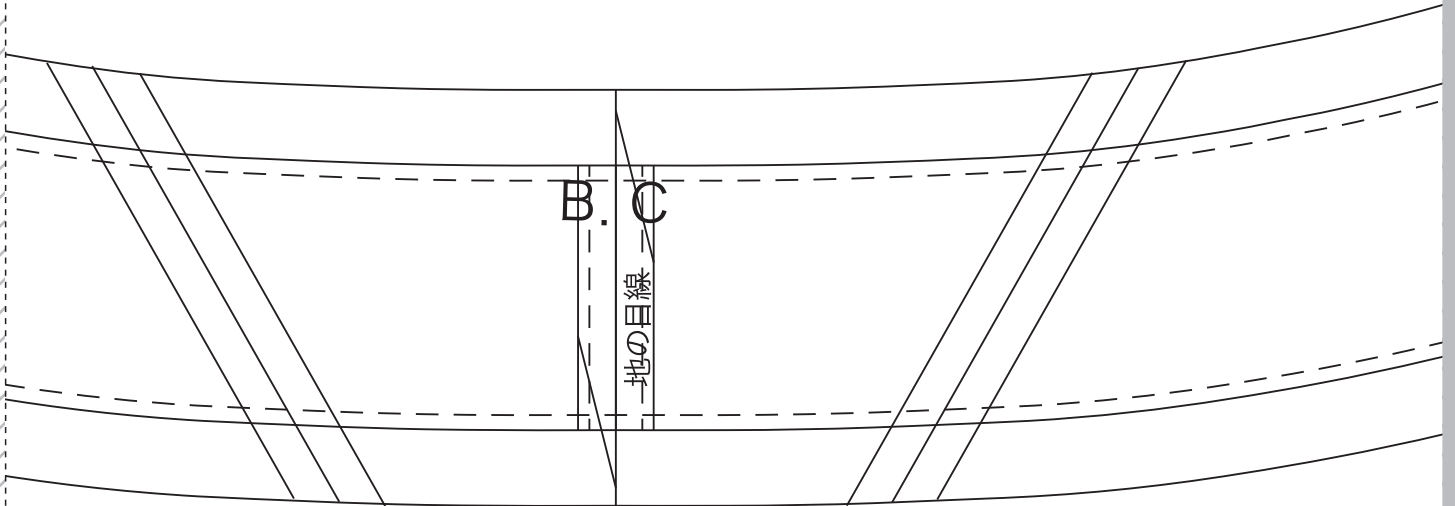

24

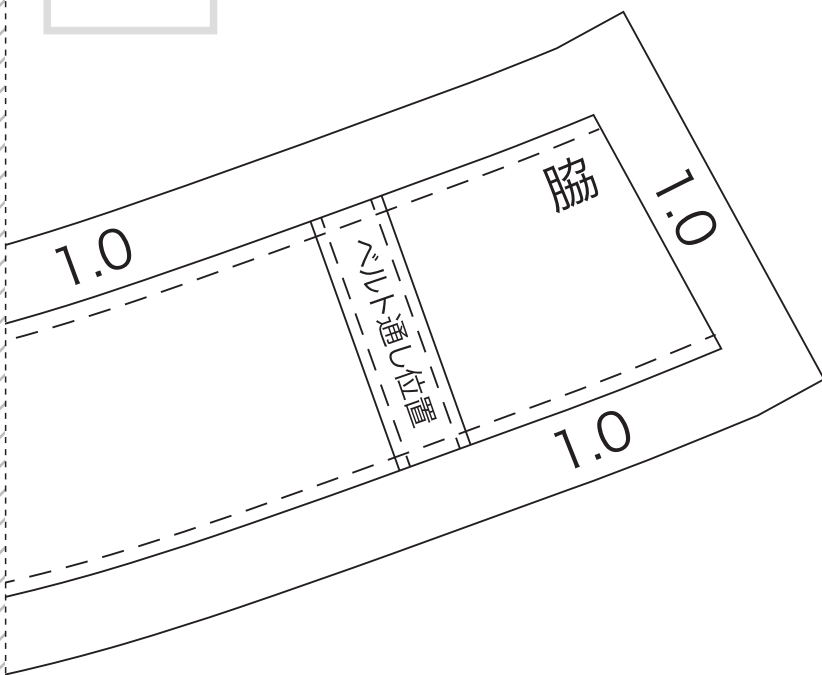

26

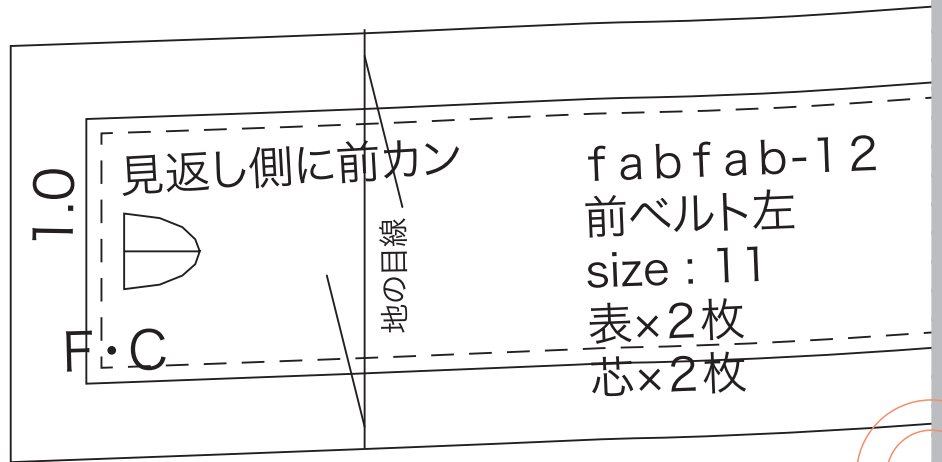

				fabfab-12			
				ベルト通し			
				size: 11			
				表×1枚			

27

