

introduction はじめに

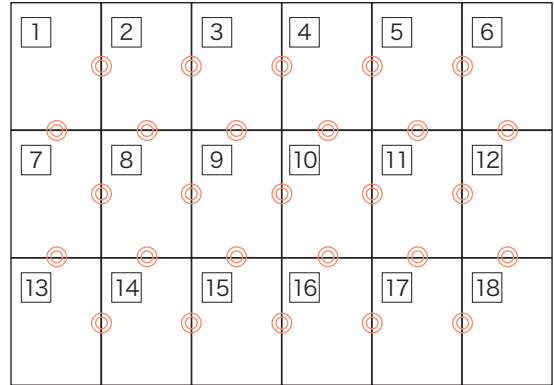

パターンは A4 サイズ 27 枚に分割されています。
印刷後、右図のようにつなぎ合わせてください。

! 印刷時の注意

印刷設定では、「ページの拡大や縮小」を選択せず
必ず、「実際のサイズ」(原寸) で印刷してください。



how to make パターンのつくりかた

STEP1 斜線部分  は切り取り、灰色部分  は残してのりしろにします。
(斜線と灰色を間違えないように注意)

STEP2 各用紙の番号を確認し、 の位置を合わせて、
のりづけします。
(水のりは用紙が波打ちます。スティック糊などをお使いください)

STEP3 それぞれのパーツをハサミで切り出します。

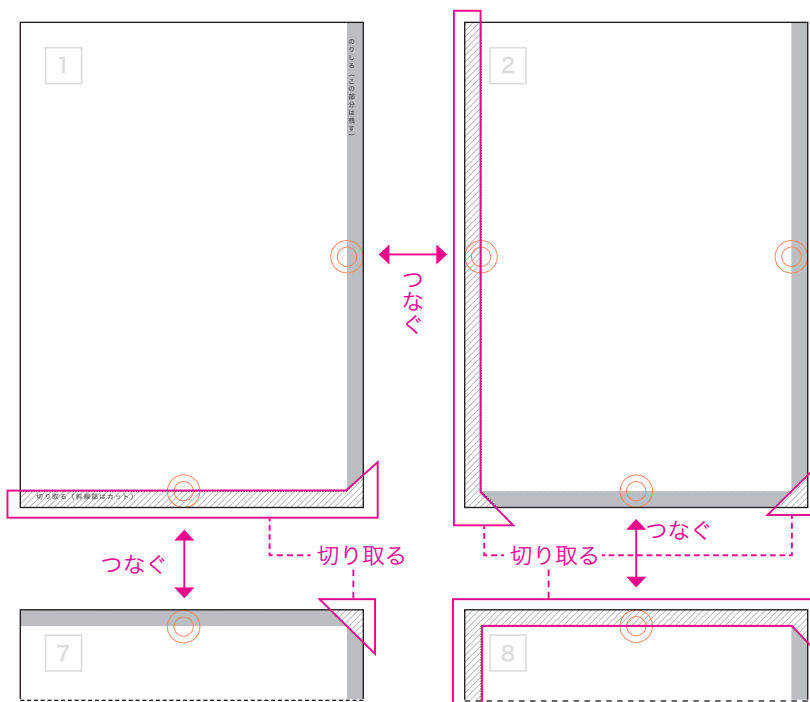
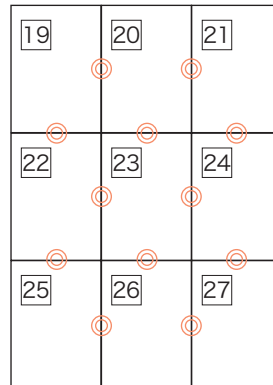

1

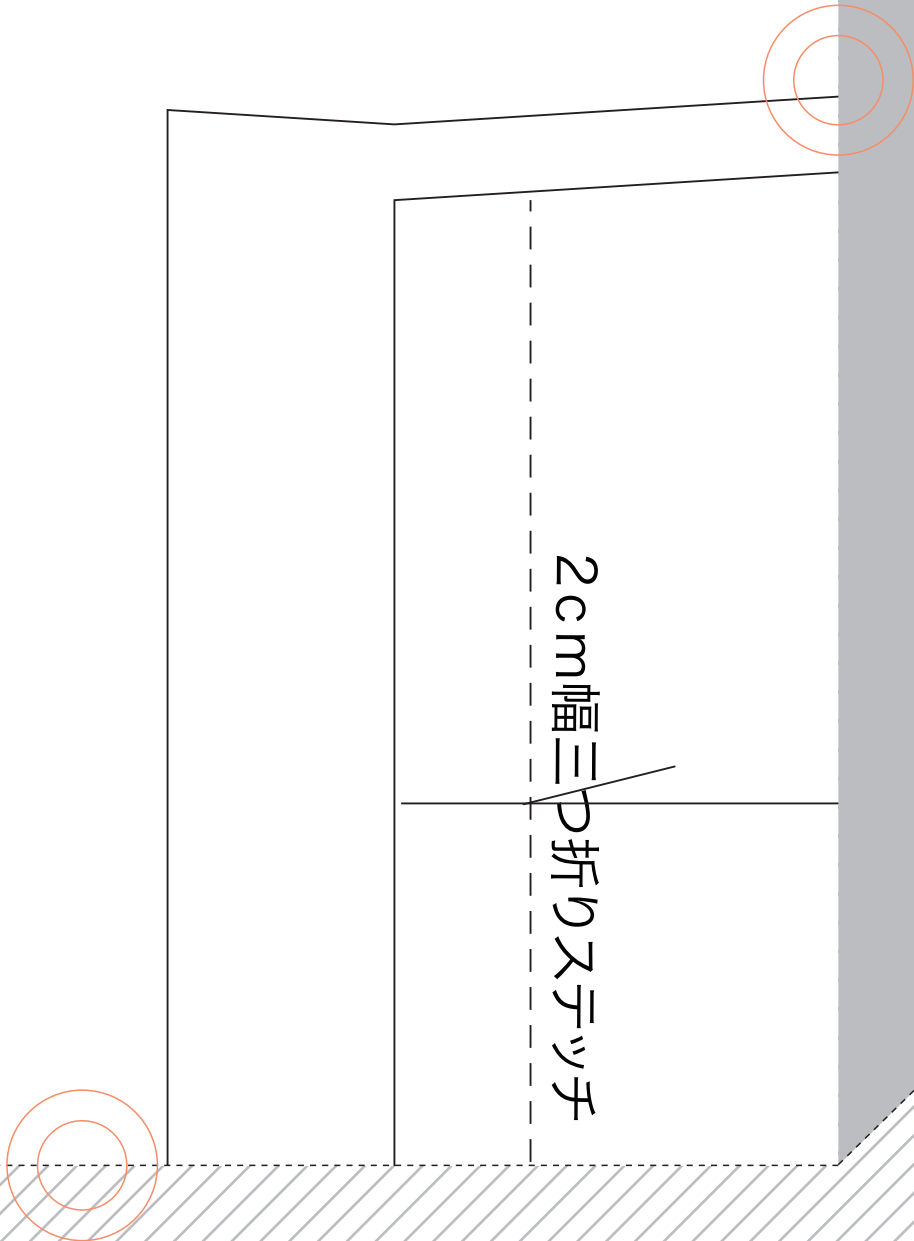

切り取る（斜線部はカット）

2

1.0

地の目線

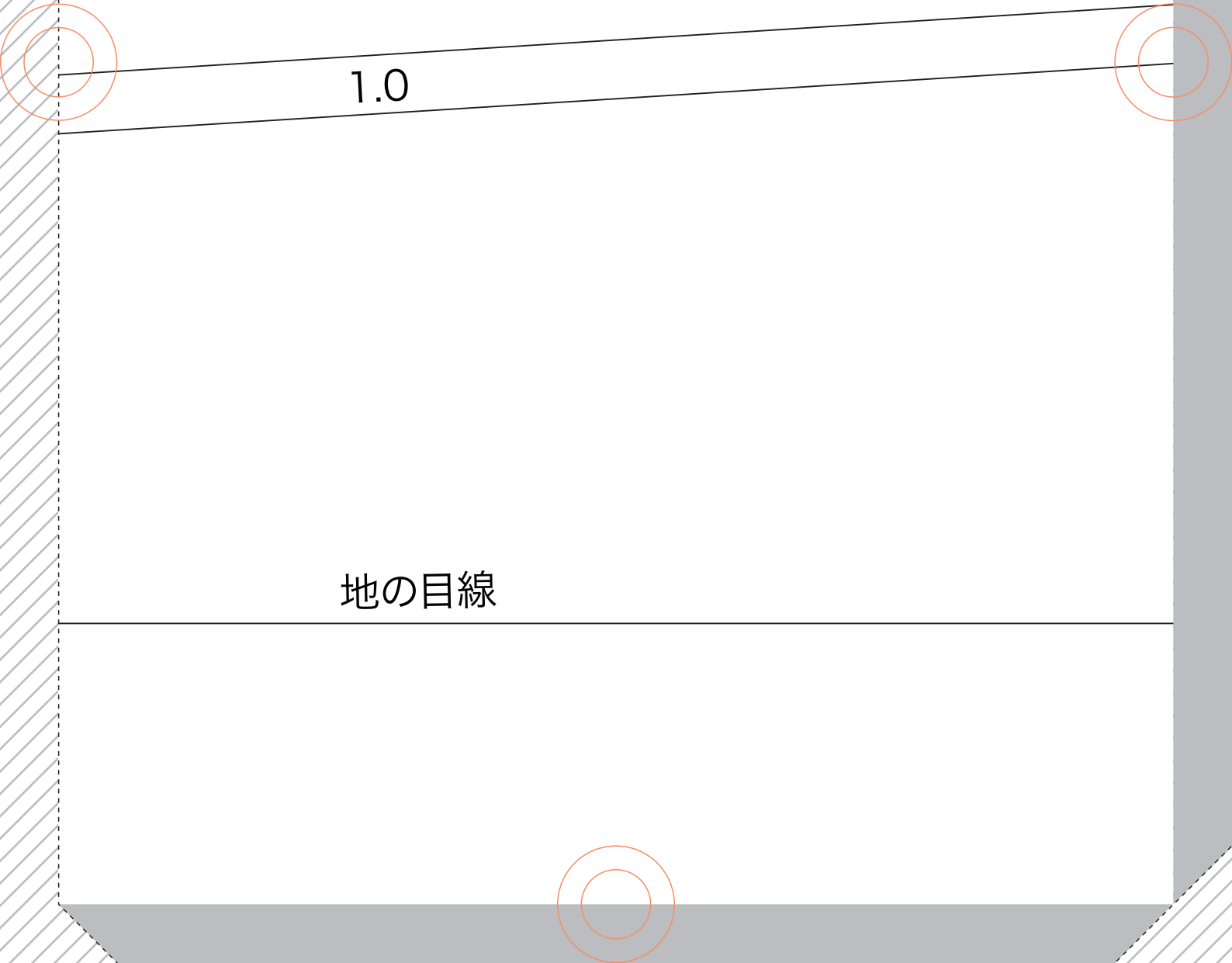

3

ロック 片倒し(後高)

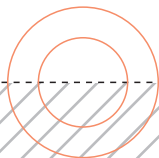
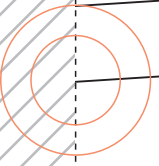

4

fabfab-12

後パンツ

size : 13

表×2枚

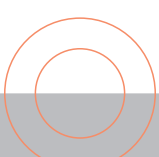
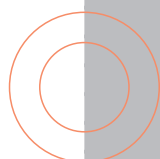
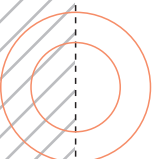

5

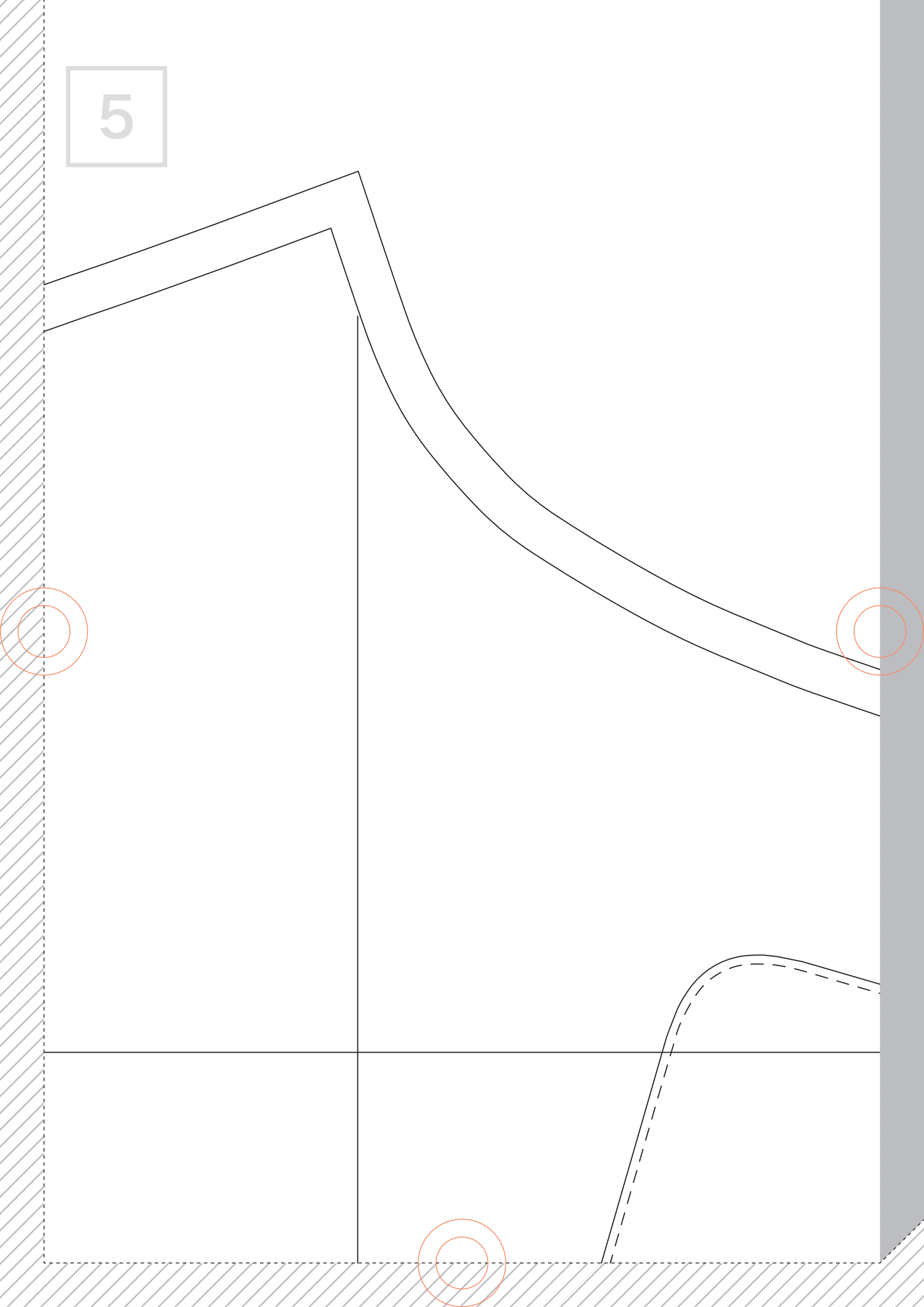

6

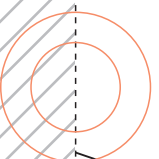

1.0

B.C

ポケット位置

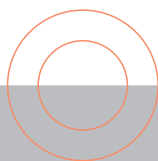

7

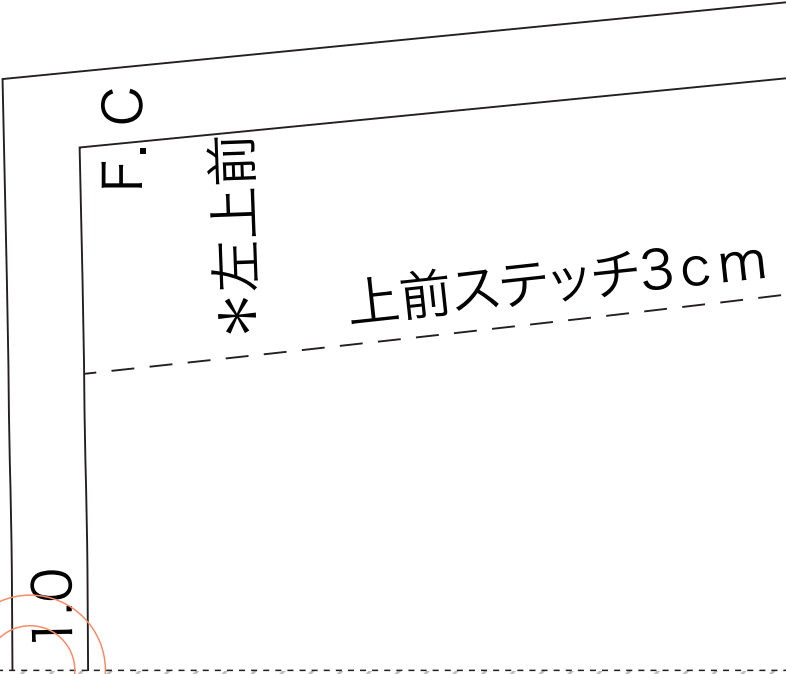
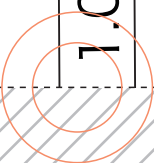
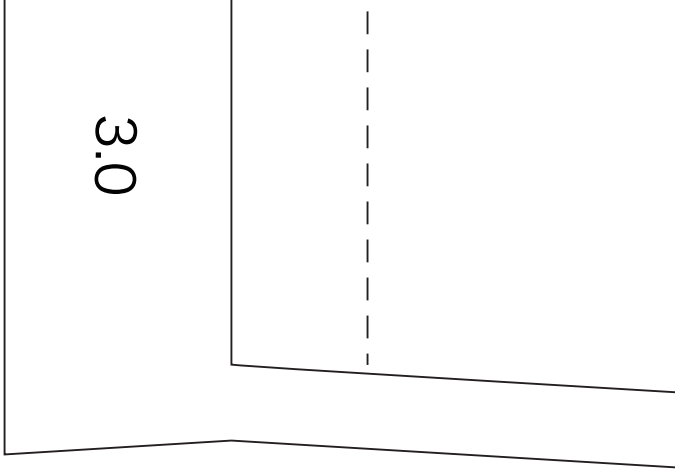
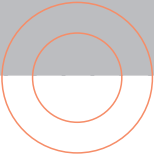

8

1.0

1.0

ファスナー開きどまり

fabfab-12

前パンツ

size : 13

表×2枚

9

ロック片倒し(後高)

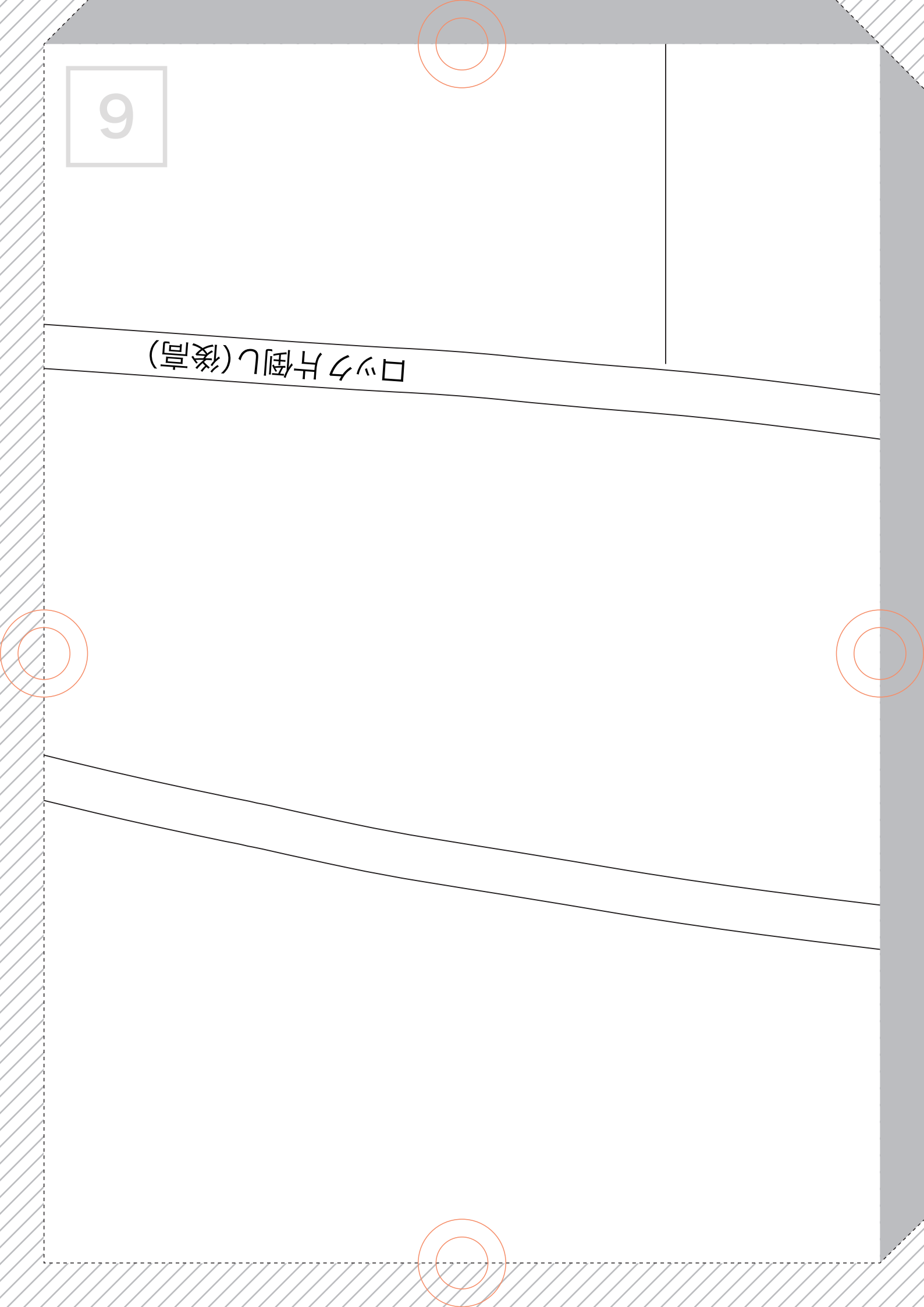

10

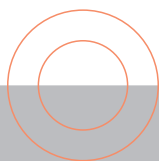
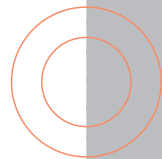
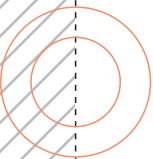
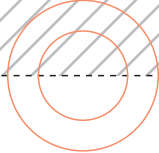

11

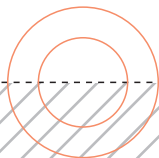
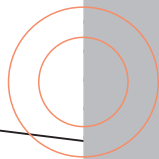
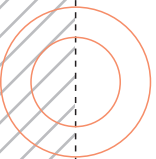
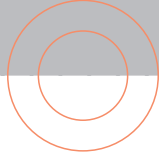

1.0

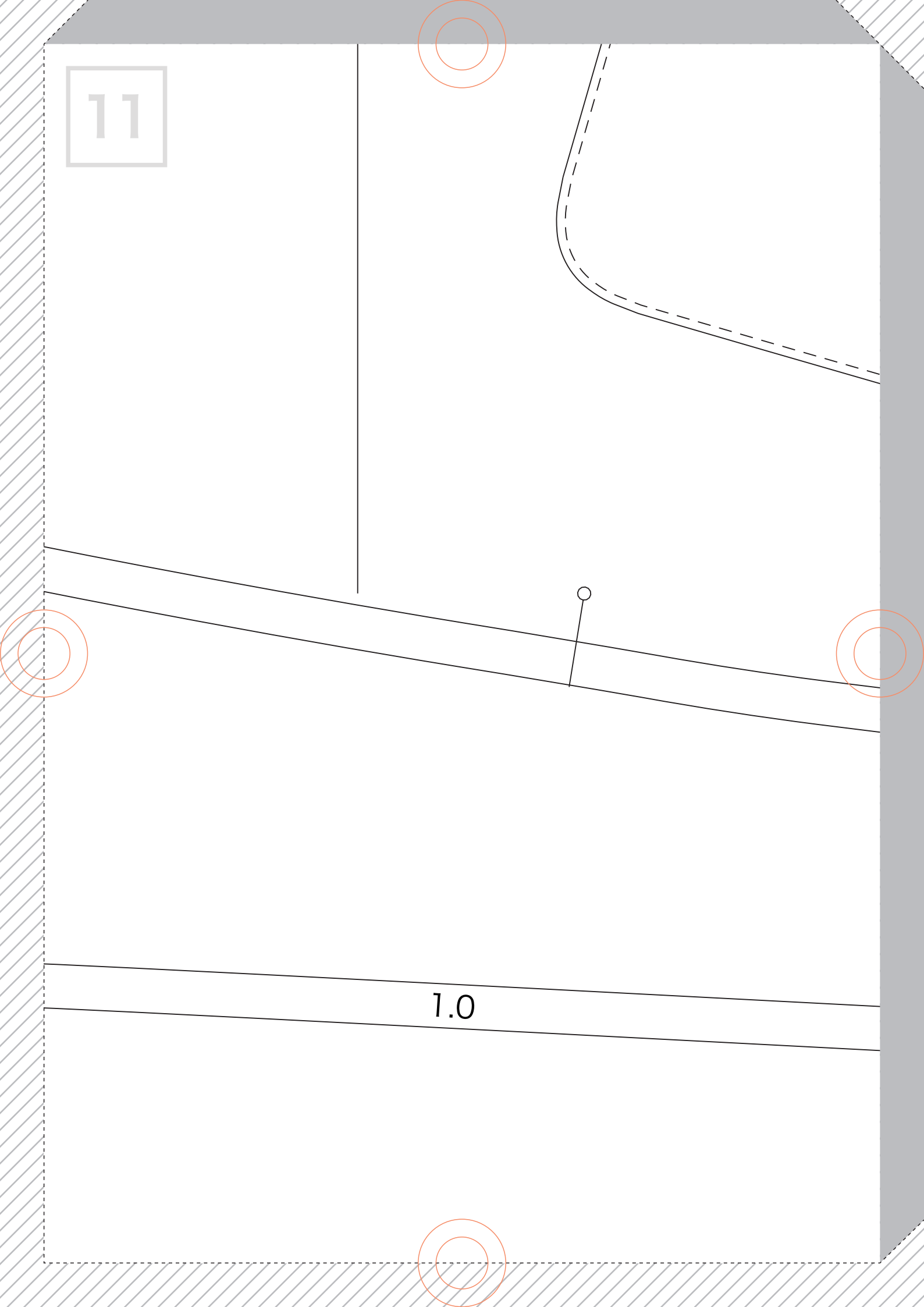

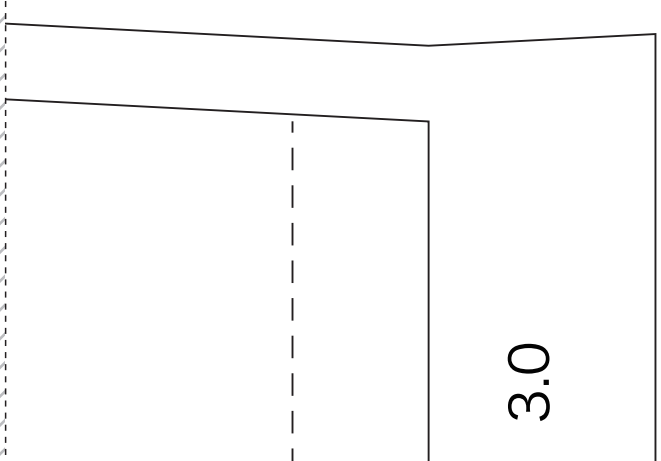
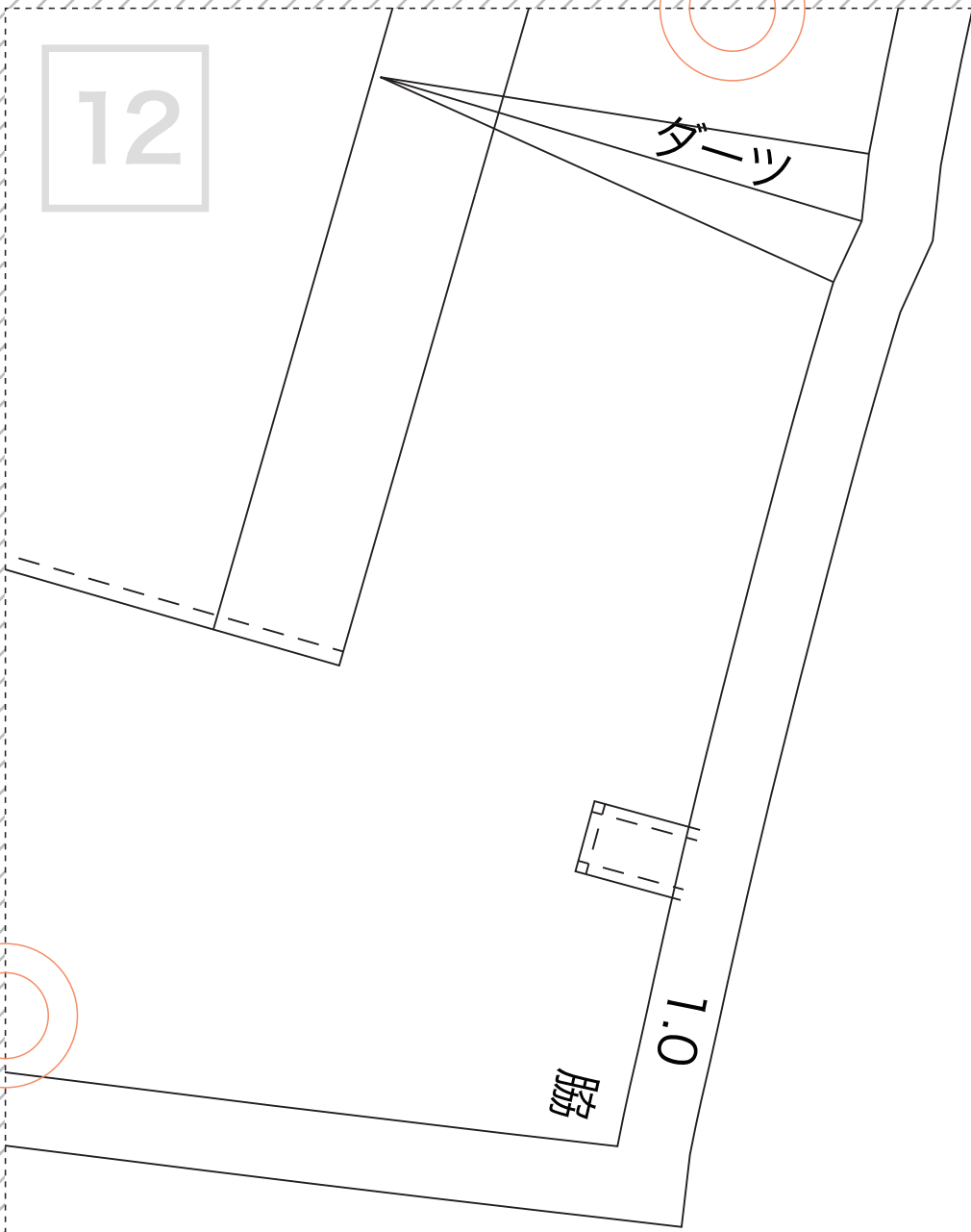

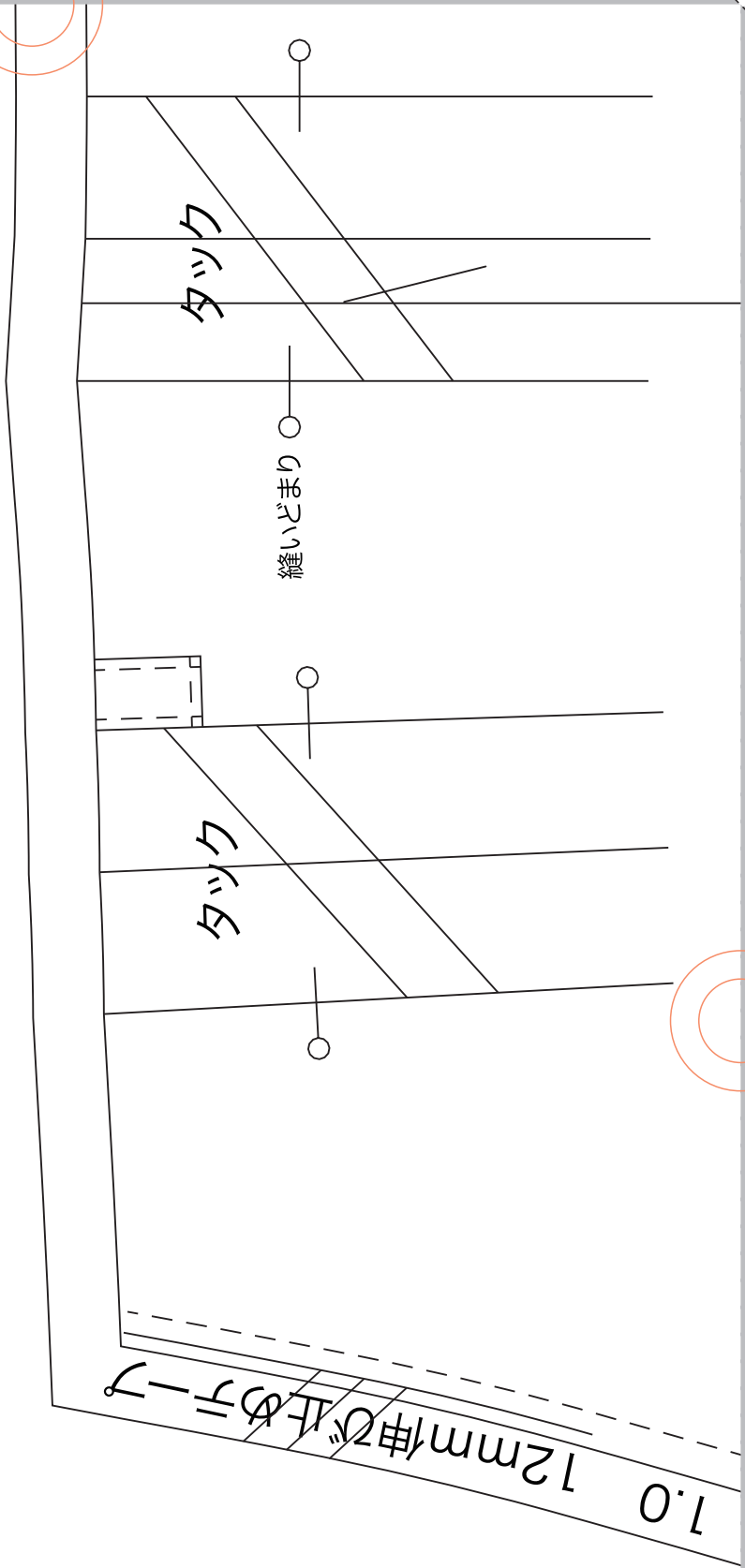
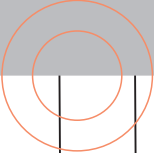

14

タツクの方向

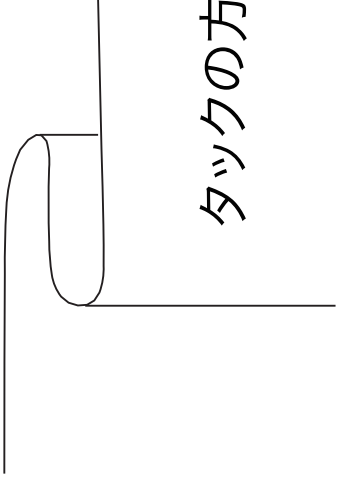

脇

ポケット口

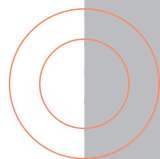
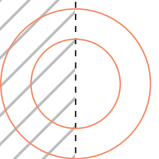
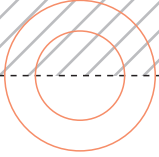

15

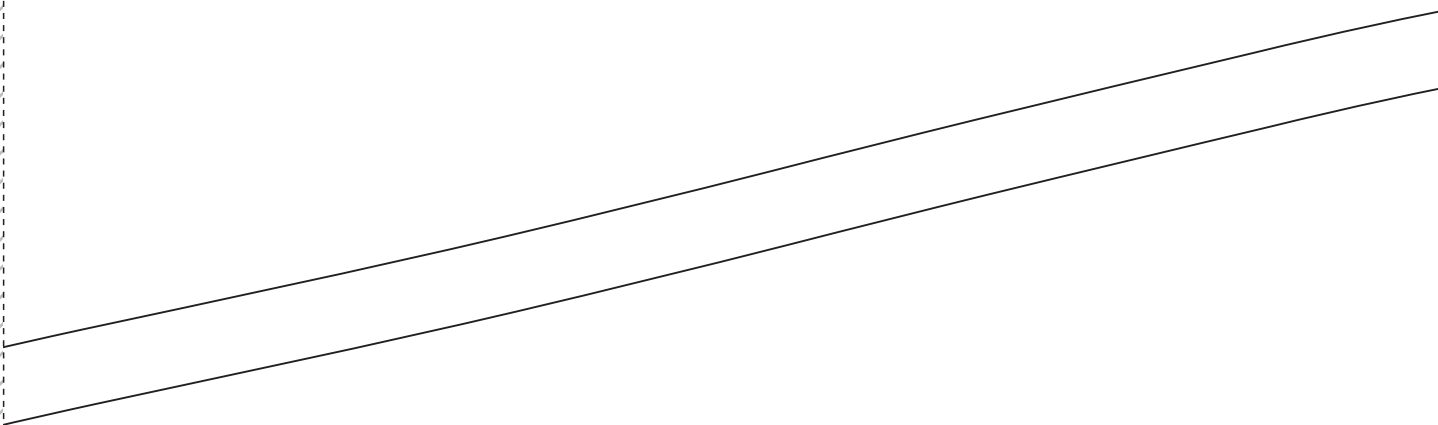
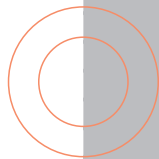
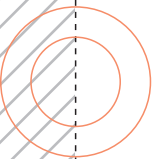
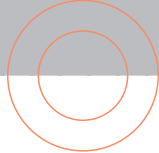

16

地目線

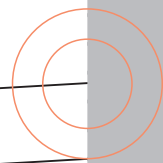
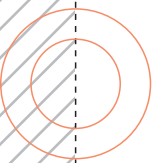
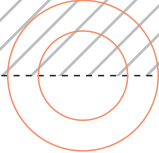

17

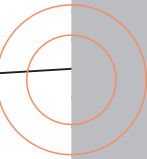
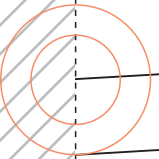
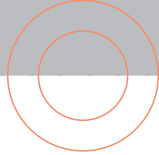

0.1

18

2cm幅三つ折りステッチ

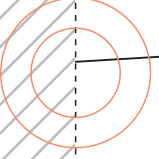
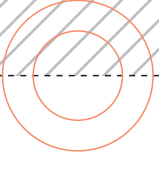

19

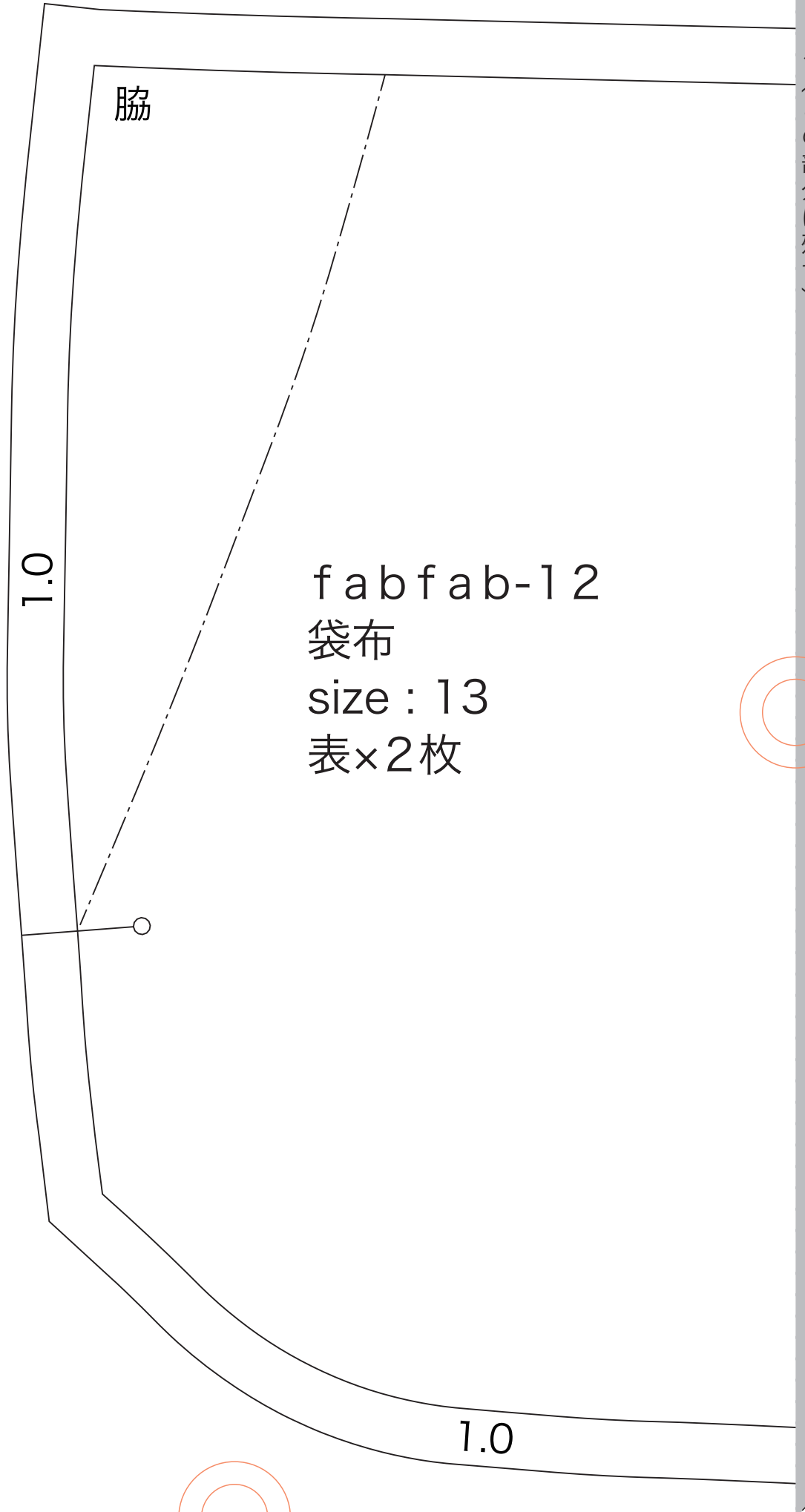

fabfab-12
袋布
size : 13
表×2枚

20

1.0

1.0

折山線

地の目線

前パンツポゲットロと接ビ

ロック

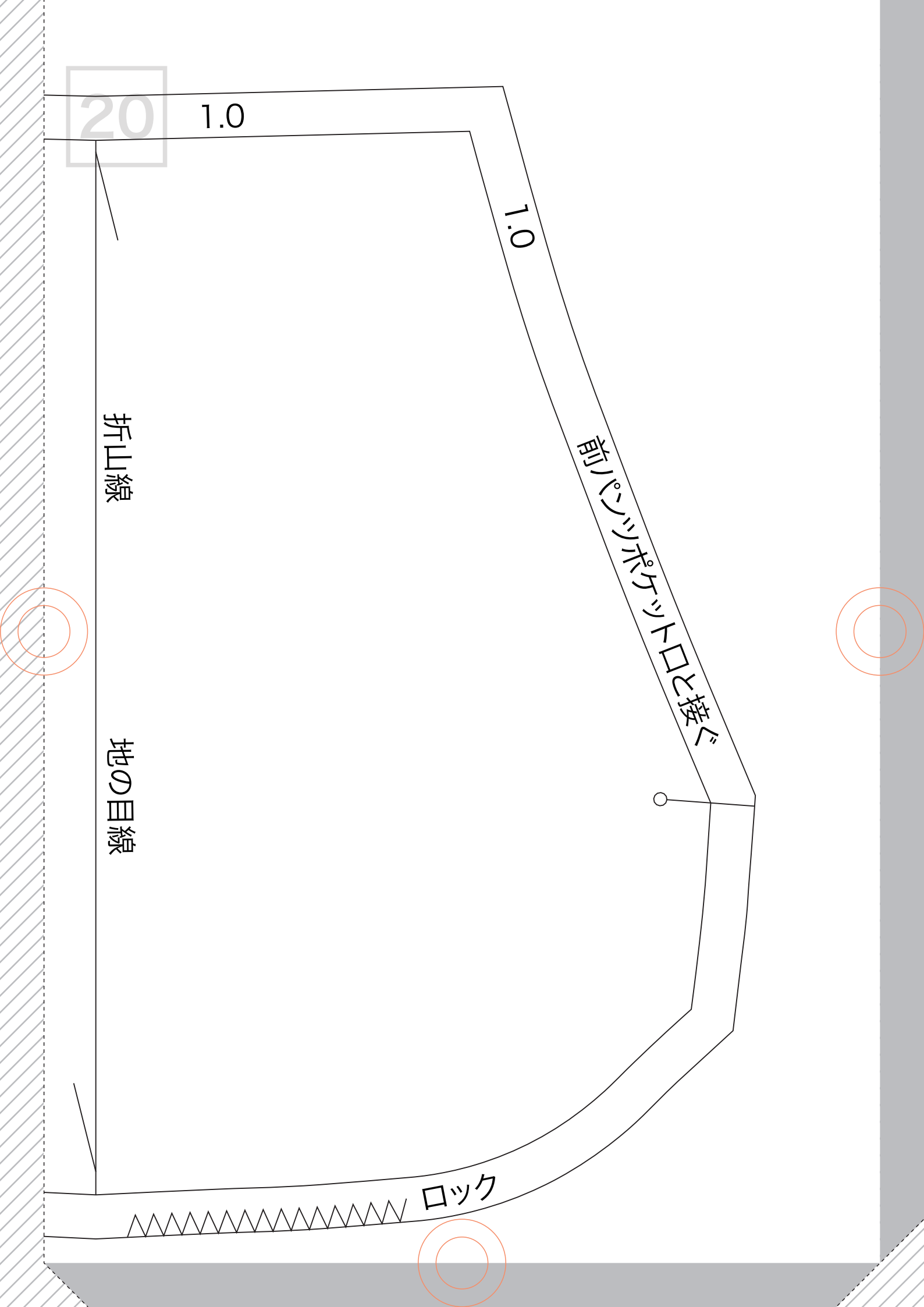

21

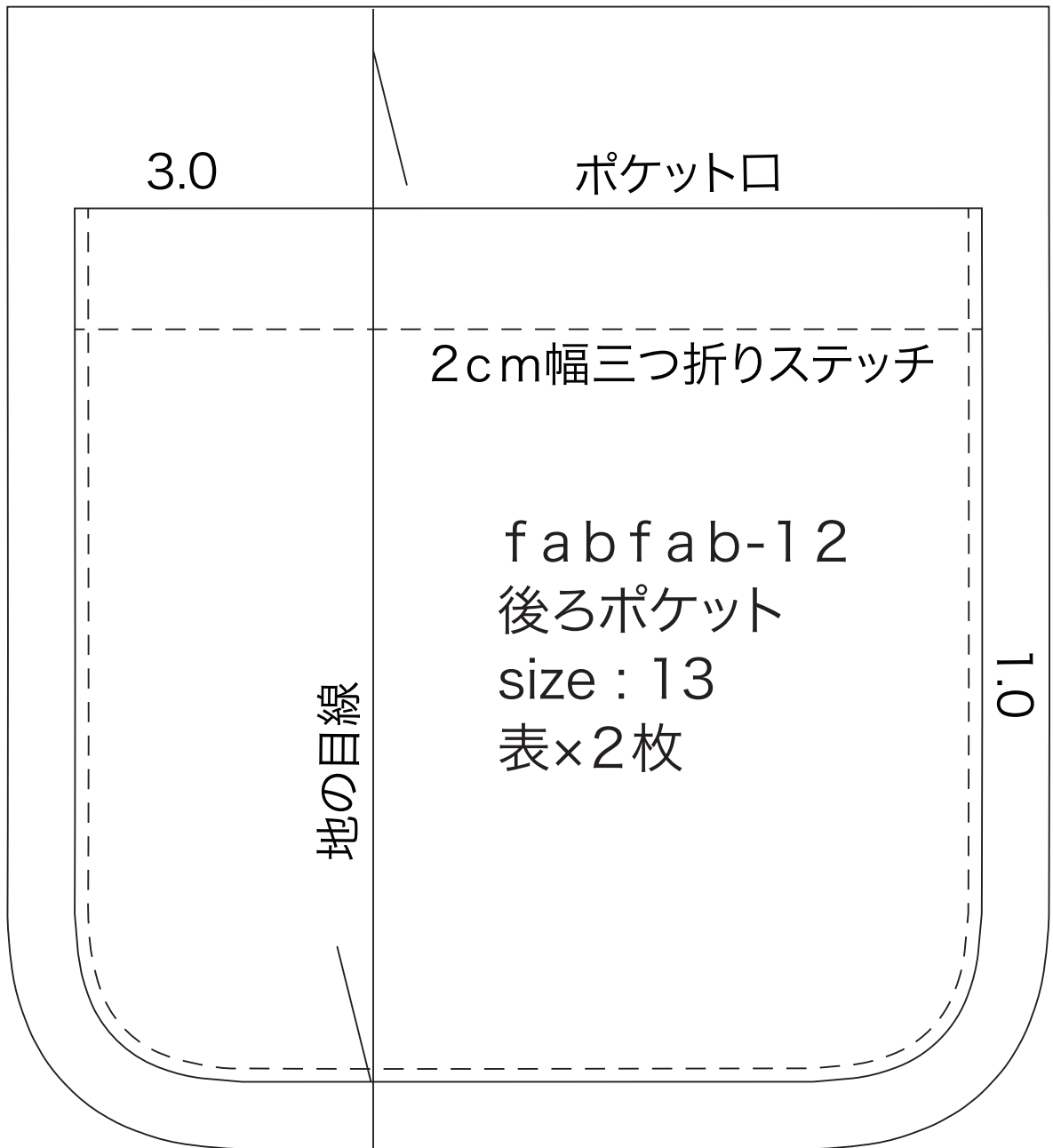

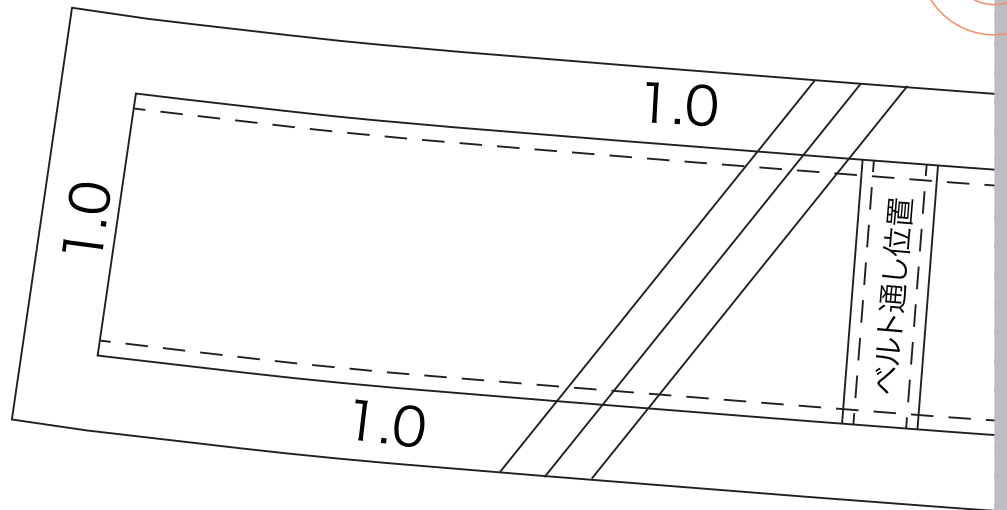
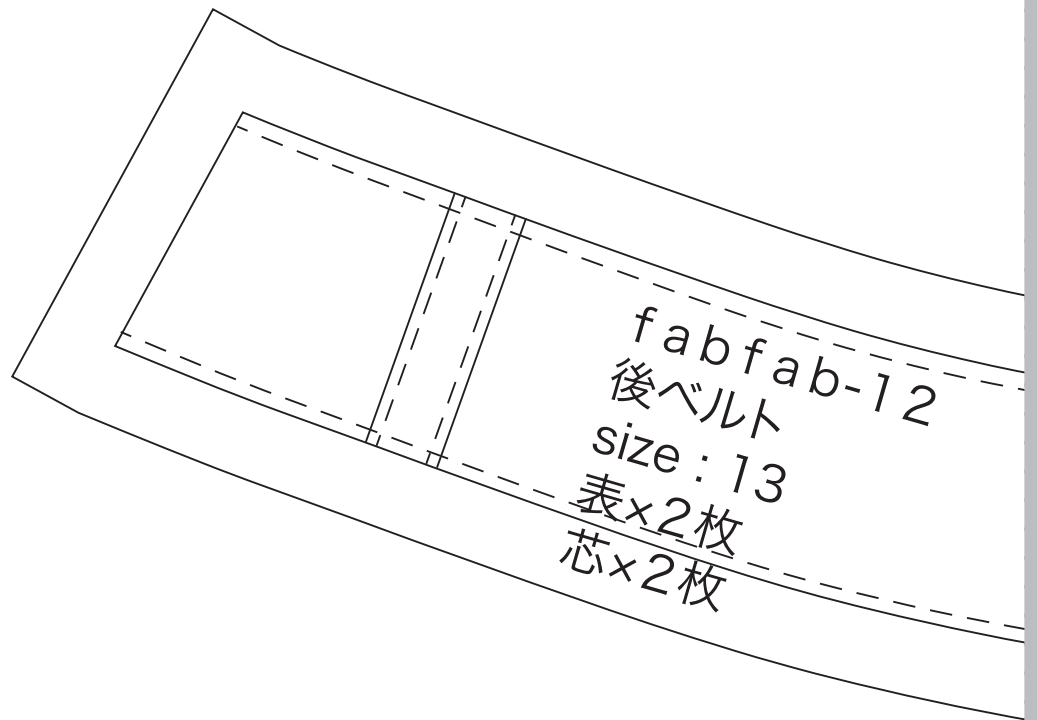

23

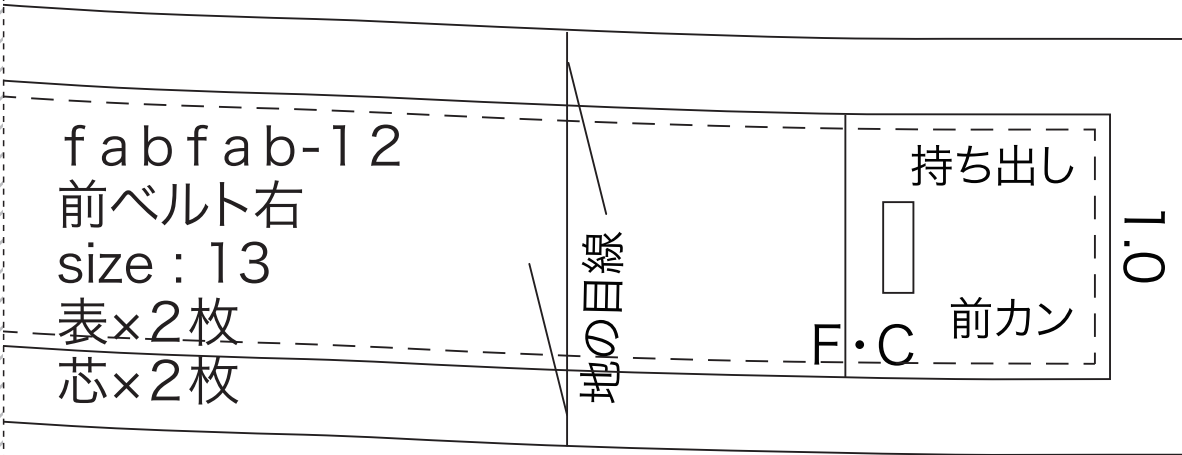
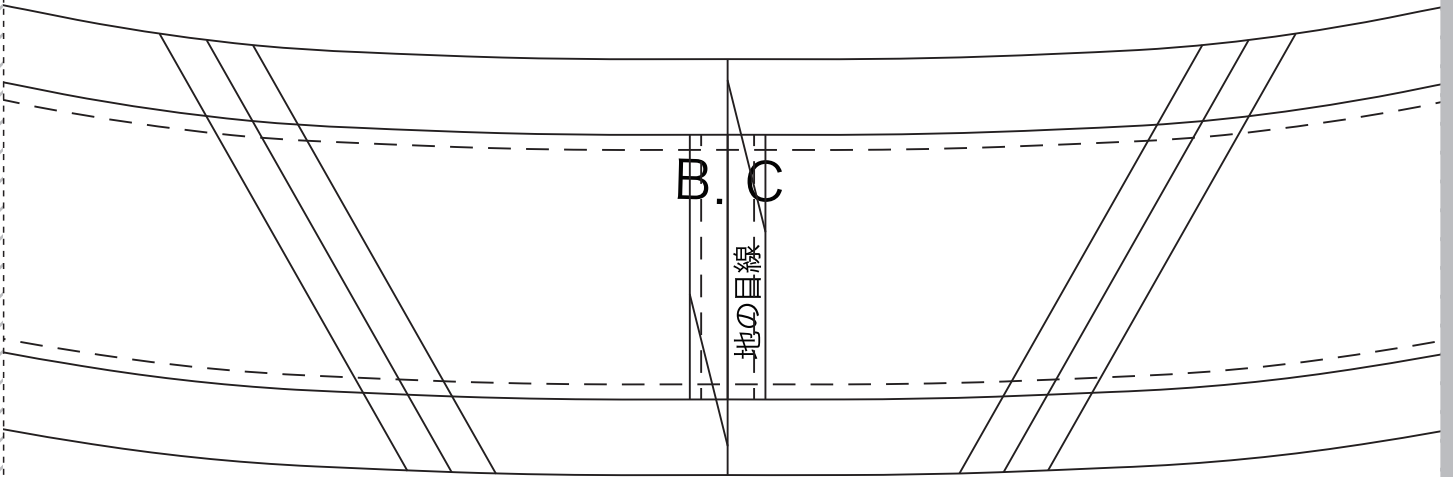

24

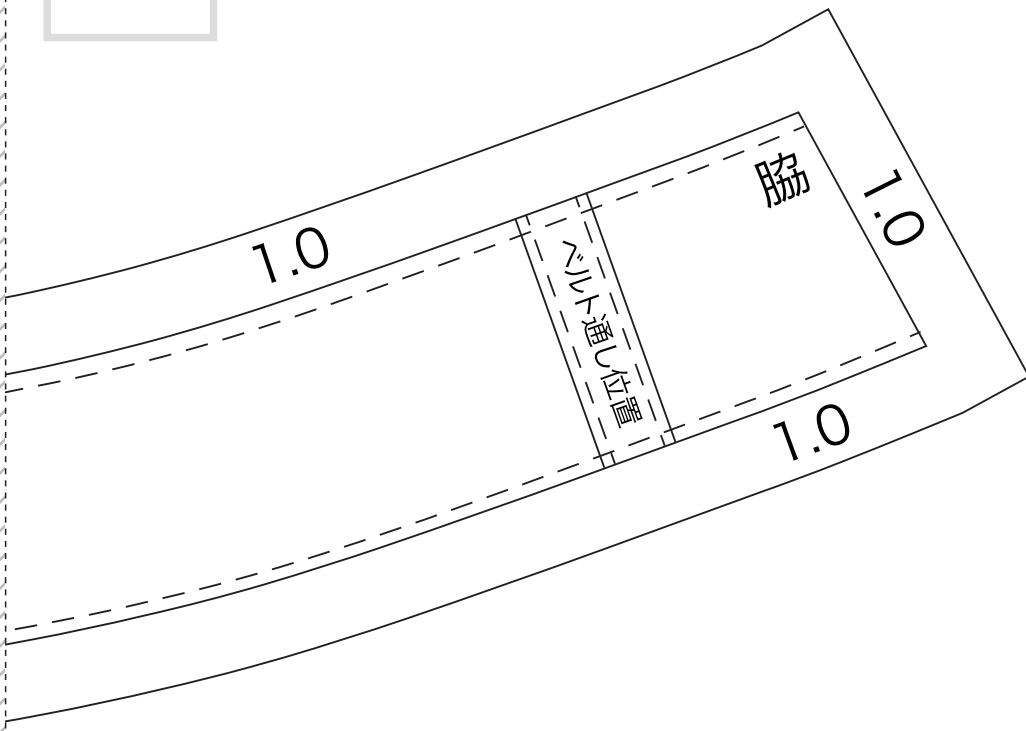

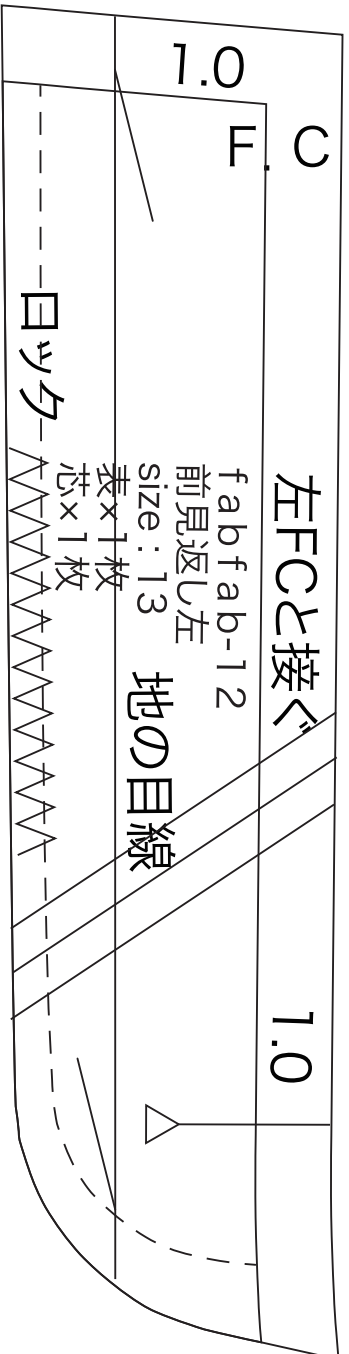
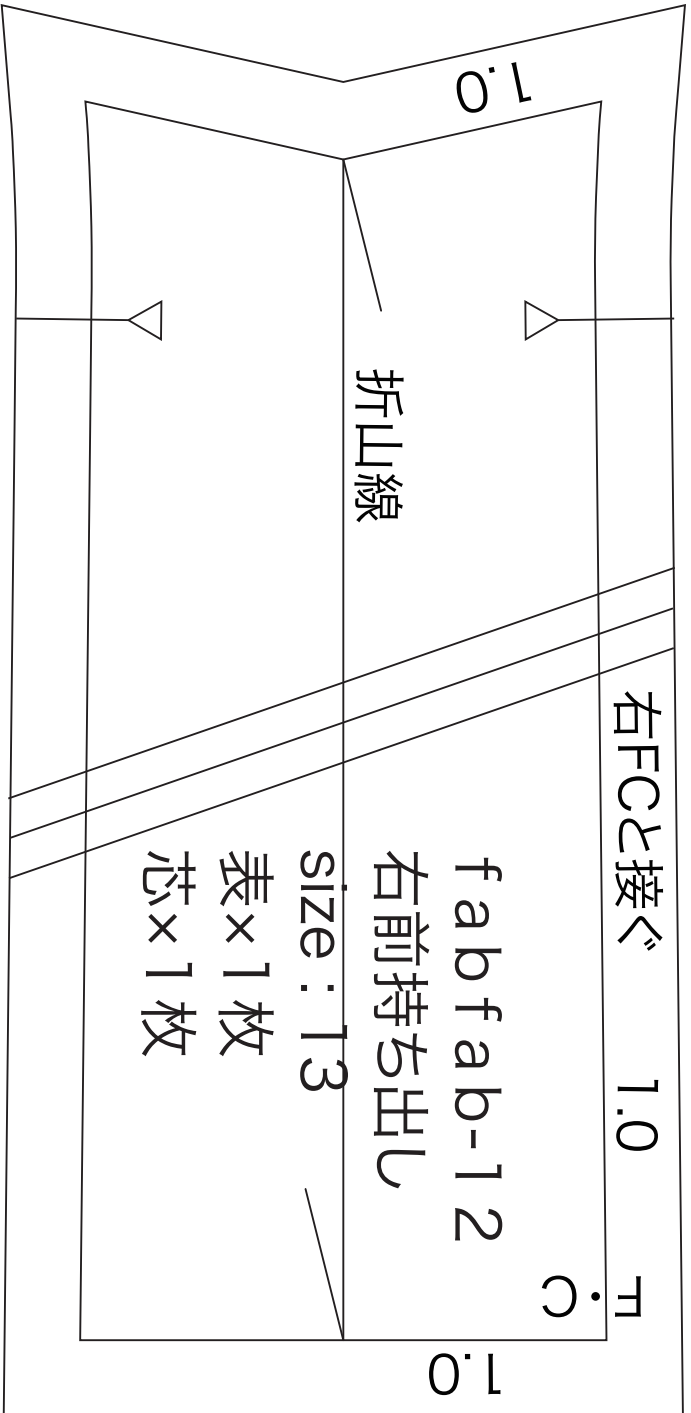

26

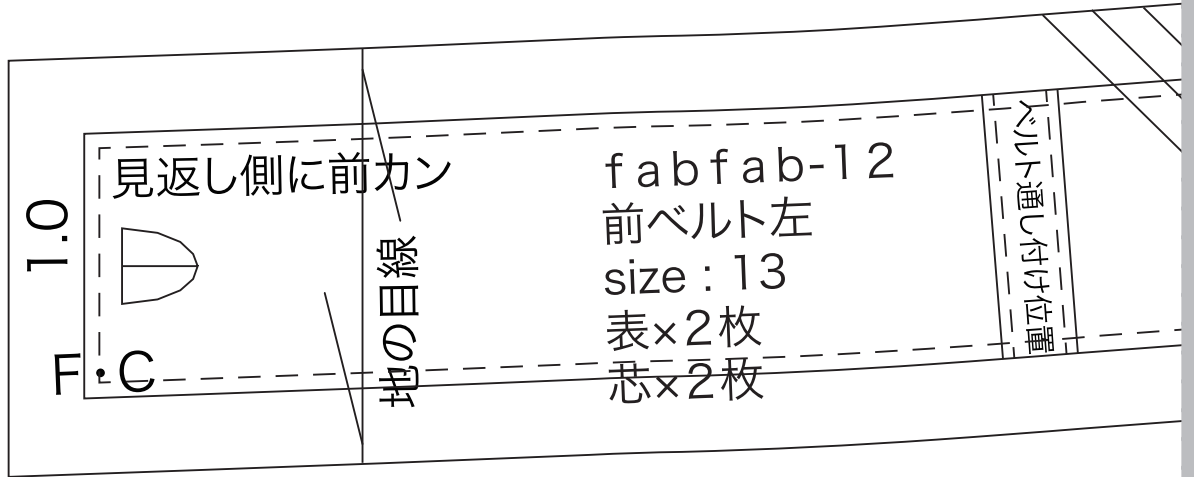

				fabfab-12			
				ベルト通し			
				size: 13			
				表×1枚			

27

