

introduction はじめに

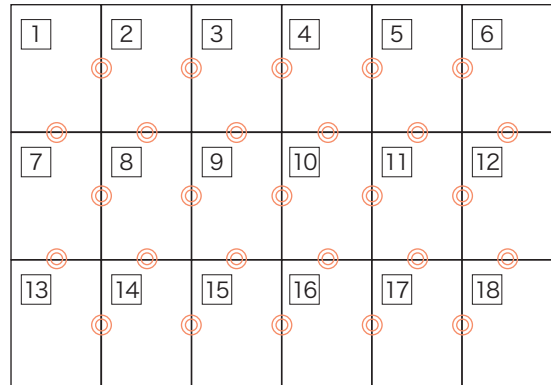

パターンは A4 サイズ 27 枚に分割されています。
印刷後、右図のようにつなぎ合わせてください。

! 印刷時の注意

印刷設定では、「ページの拡大や縮小」を選択せず
必ず、「実際のサイズ」(原寸) で印刷してください。



how to make パターンのつくりかた

STEP1 斜線部分  は切り取り、灰色部分  は残してのりしろにします。
(斜線と灰色を間違えないように注意)

STEP2 各用紙の番号を確認し、 の位置を合わせて、
のりづけします。
(水のりは用紙が波打ちます。スティック糊などをお使いください)

STEP3 それぞれのパーツをハサミで切り出します。

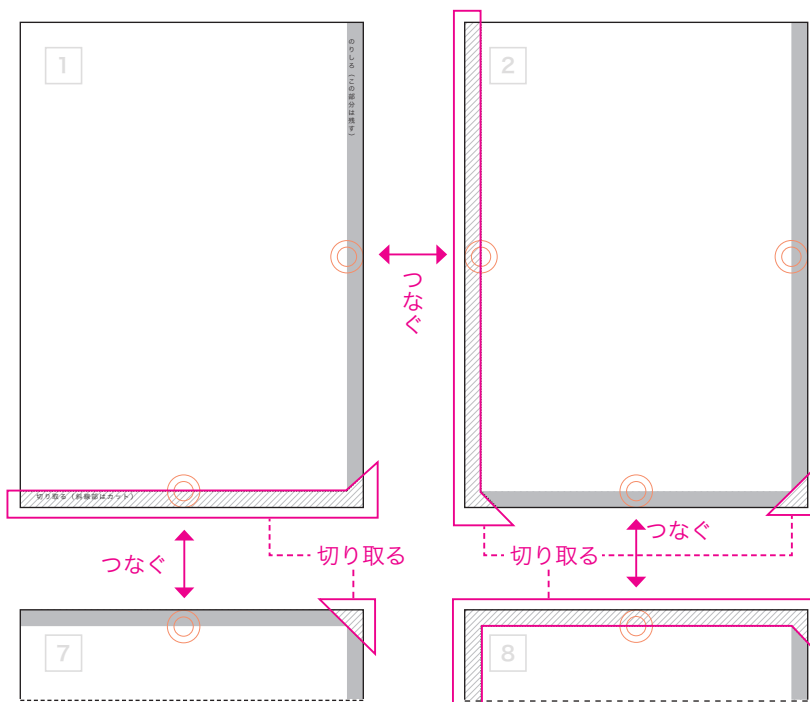
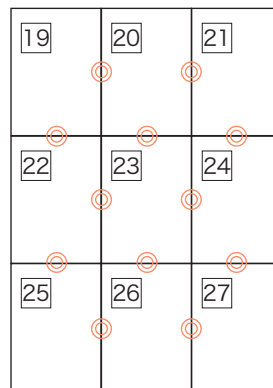

1

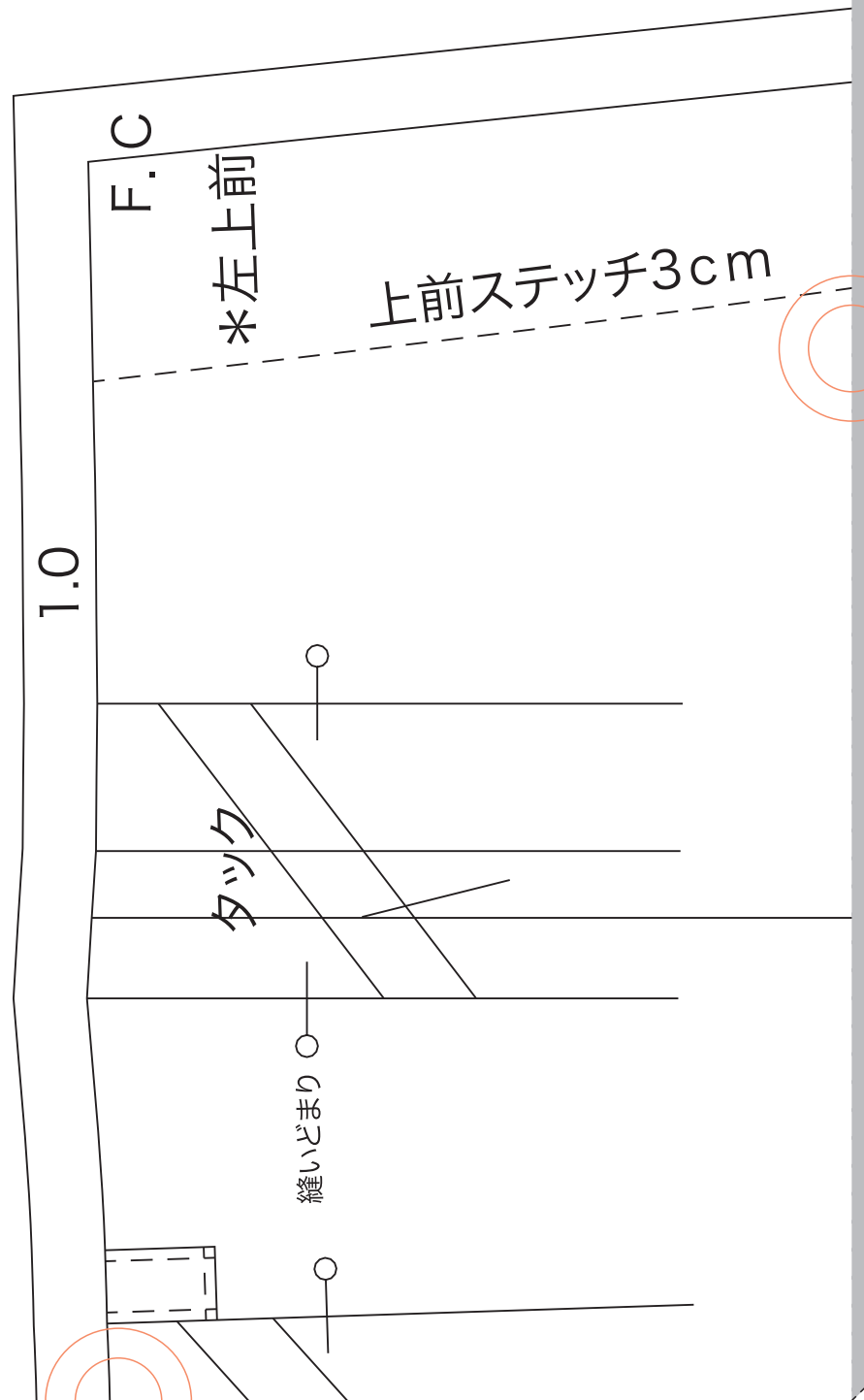

切り取る (斜線部はカット)

2

ファスナー開きどまり

1.0

タックの方向

fabfab-12

前パンツ

size : 9

表×2枚

3

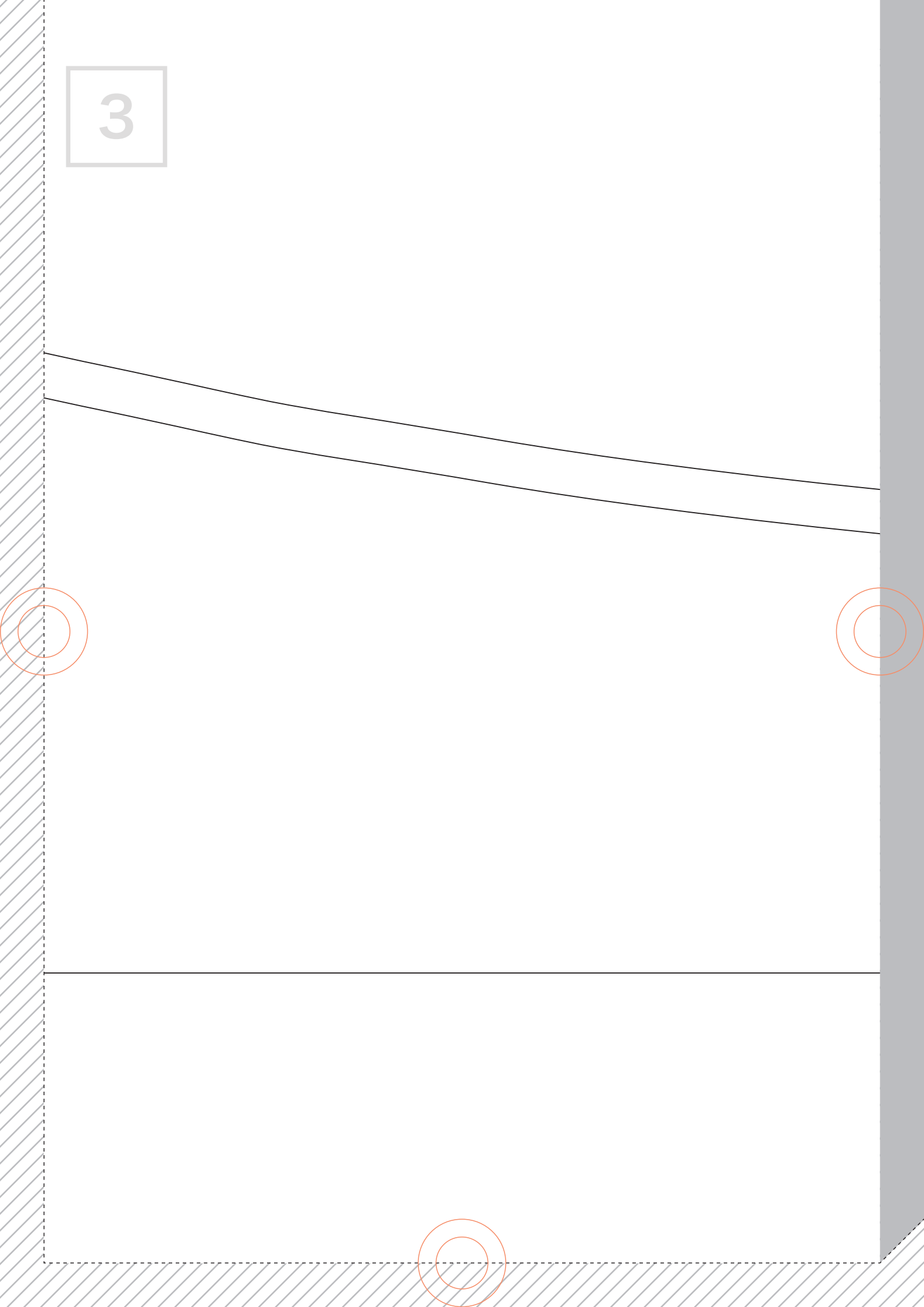
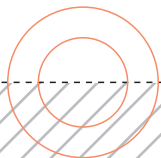
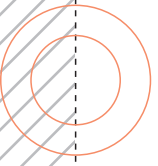

4

地の目線

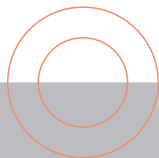
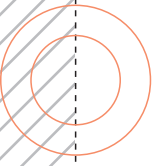

5

1.0

2cm幅三ツ折りステッチ

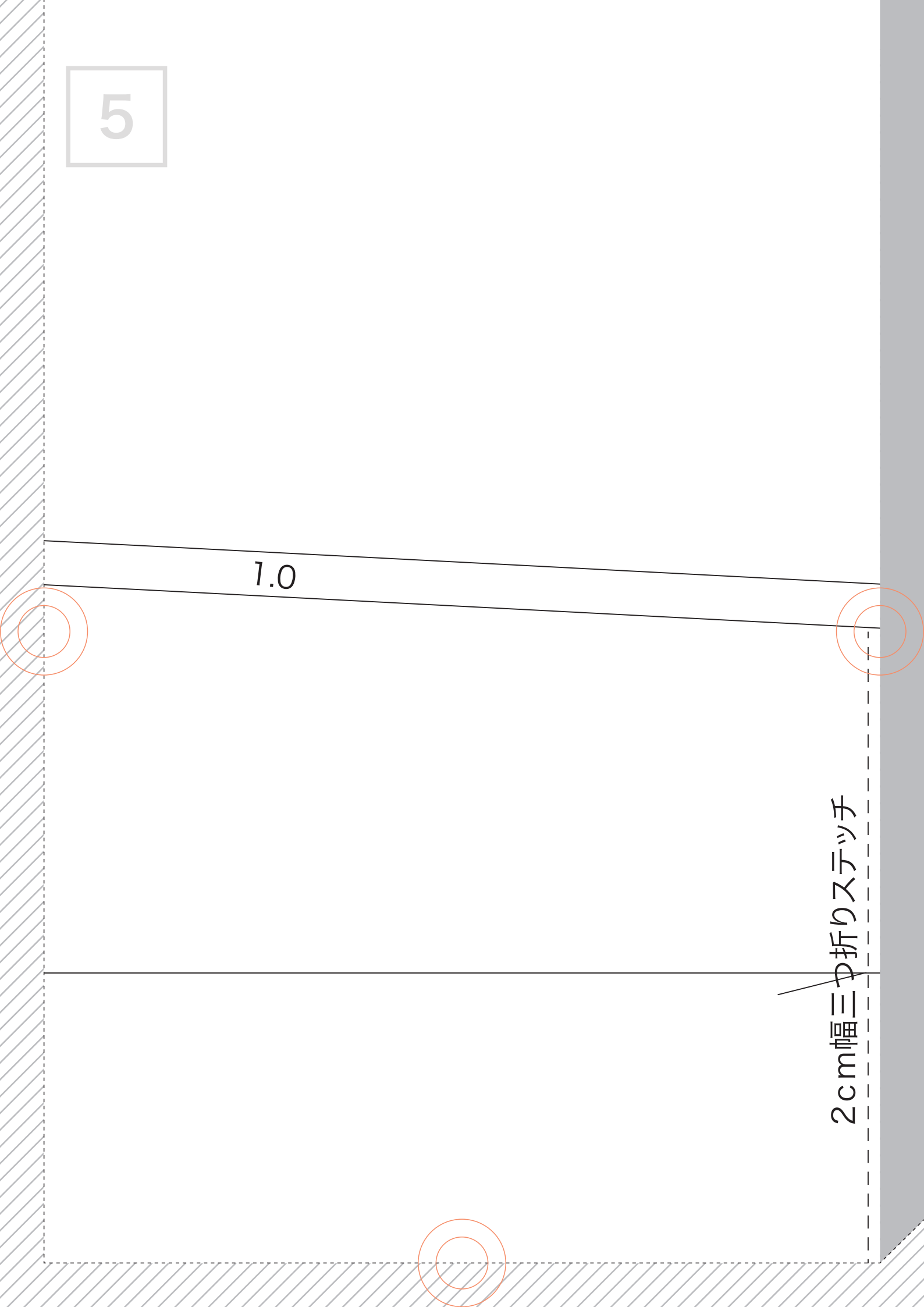

6

3.0

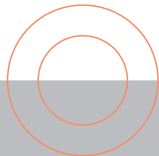
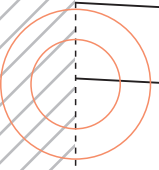

7

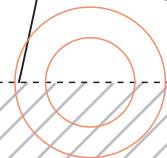
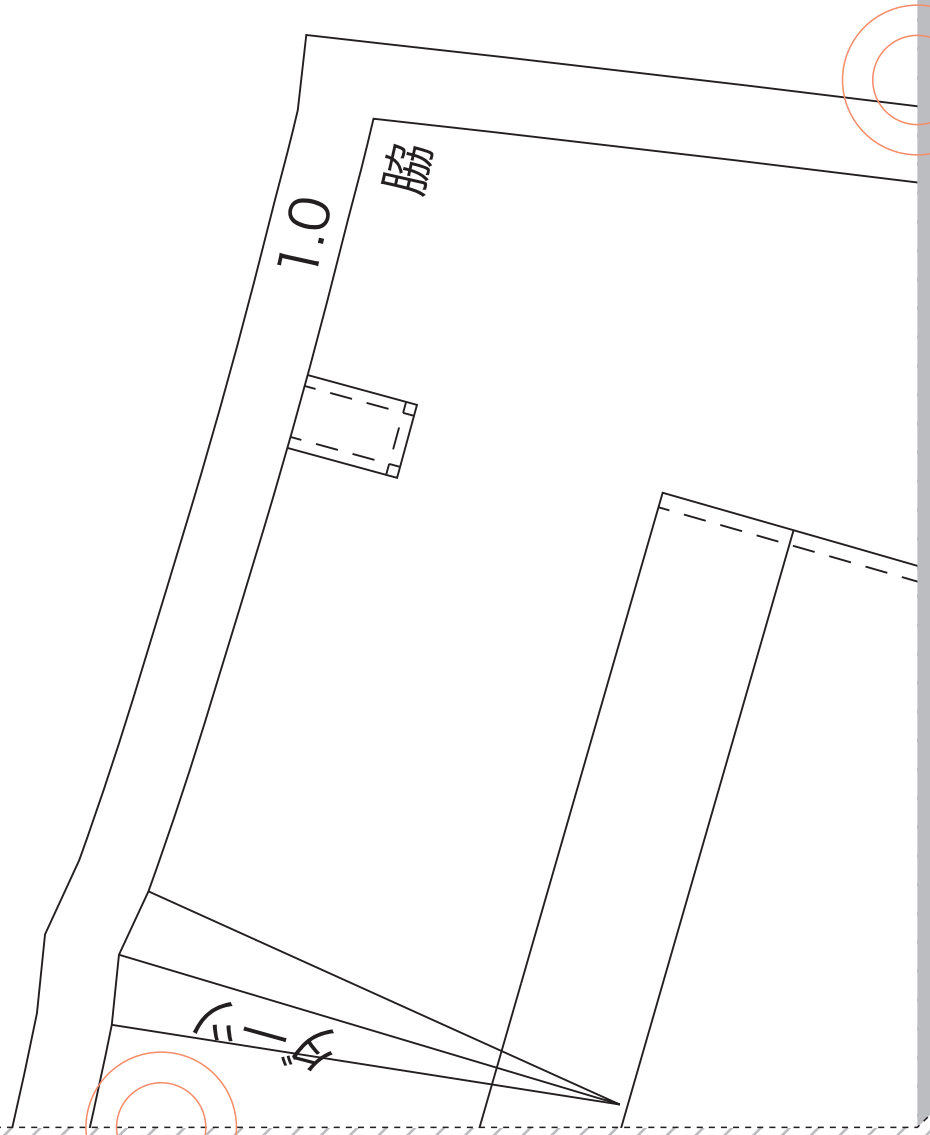
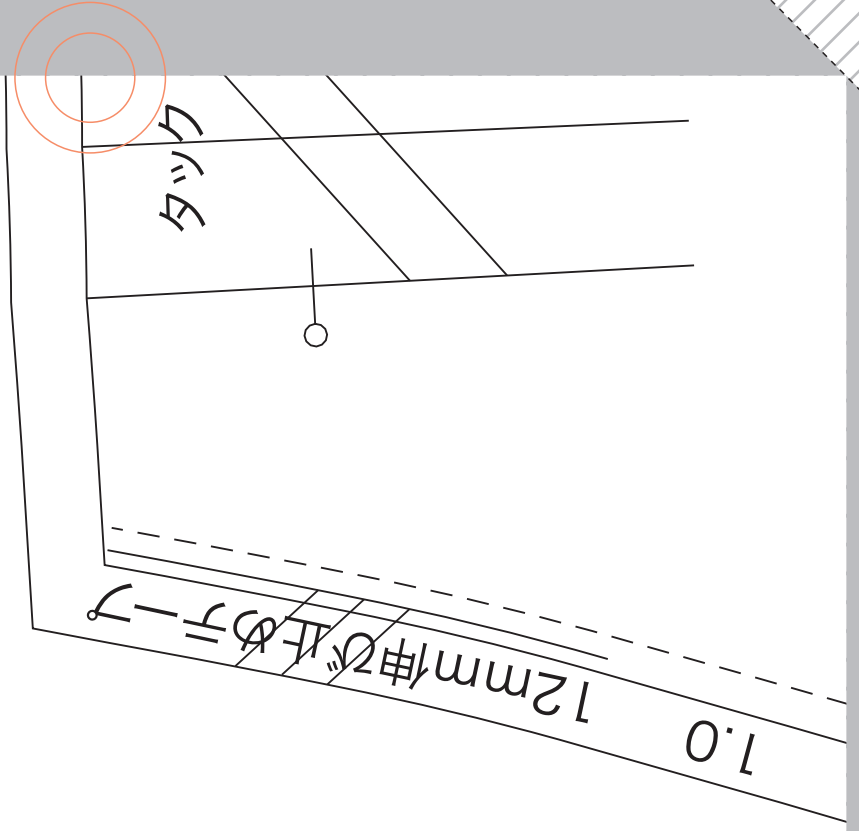

8

脇

ポケット口

fabfab-12

後パンツ

size : 9

表×2枚

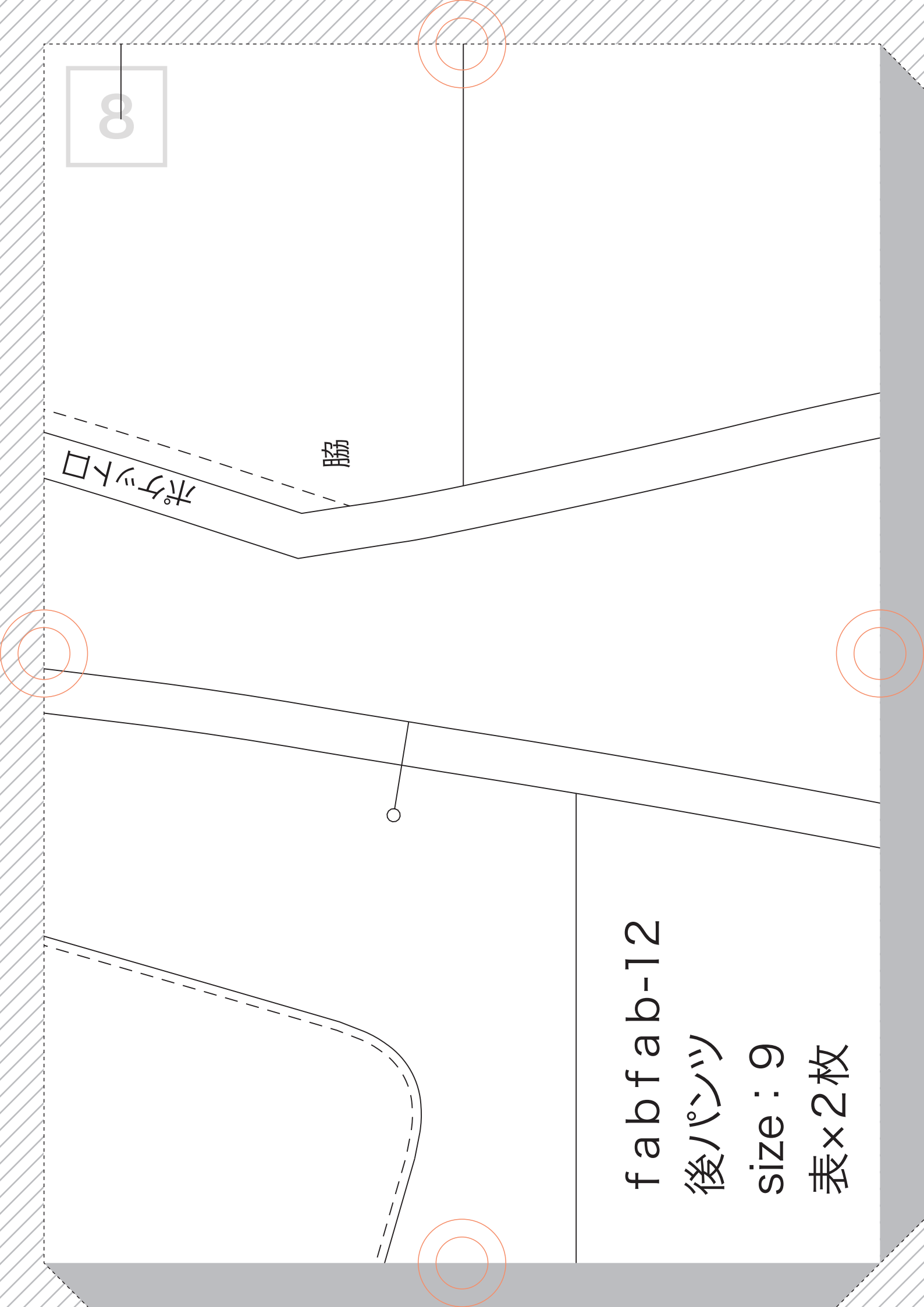

9

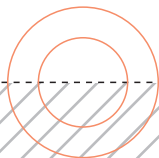
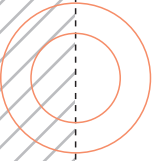
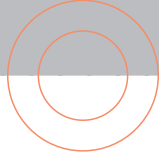

10

ロック 片倒し(後高)

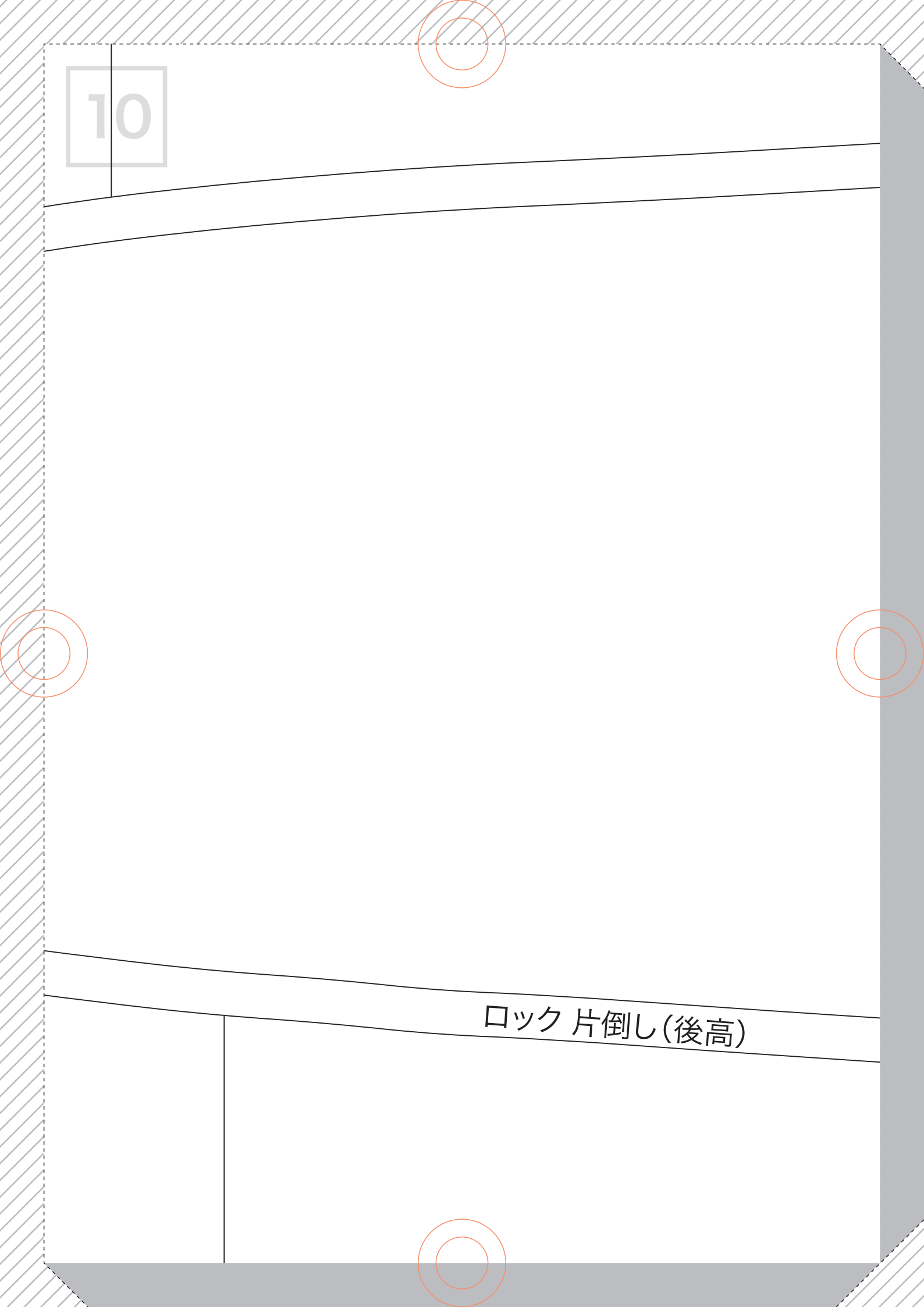

11

0.1

1.0

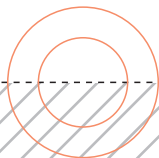
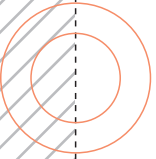
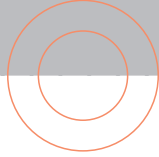

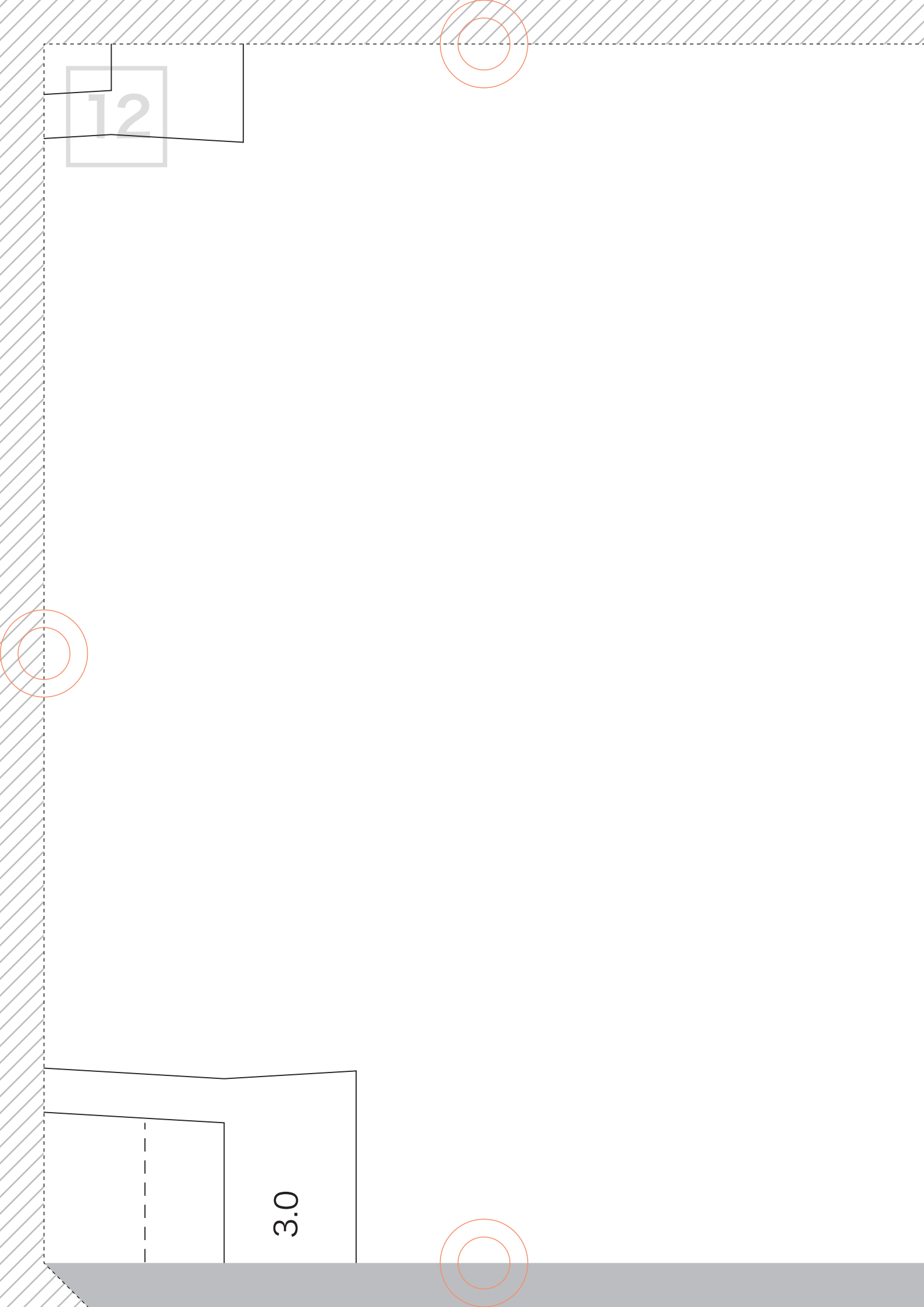

12

3.0

13

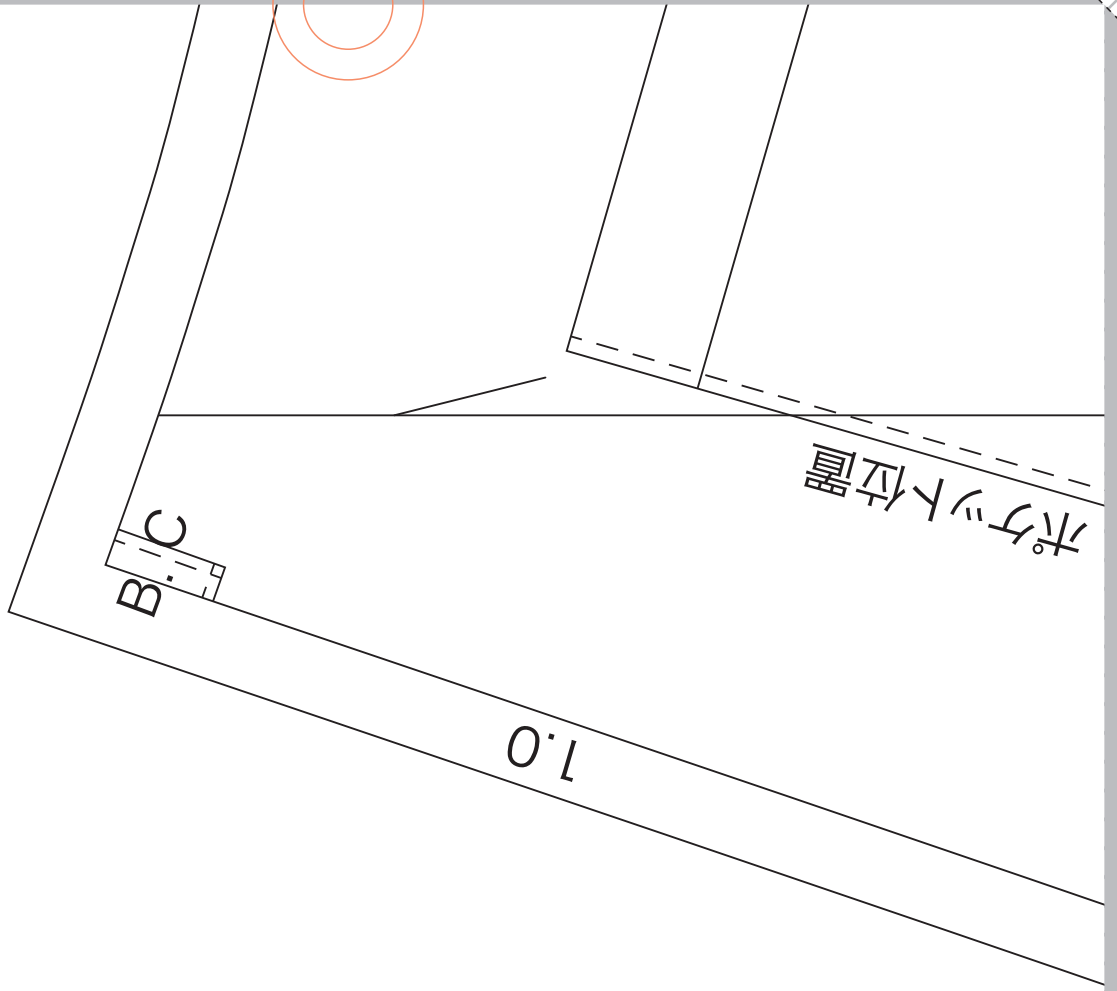

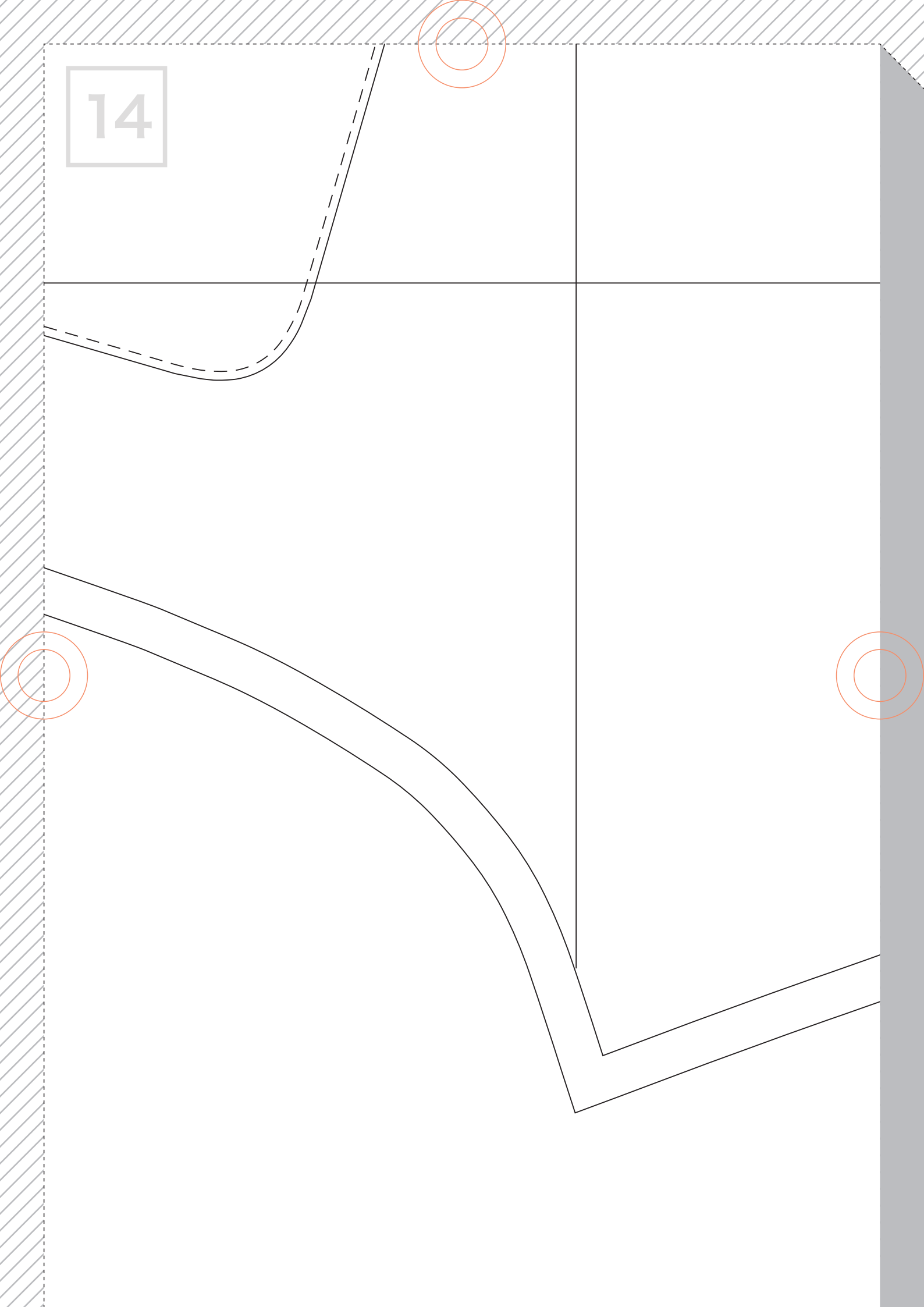

14

15

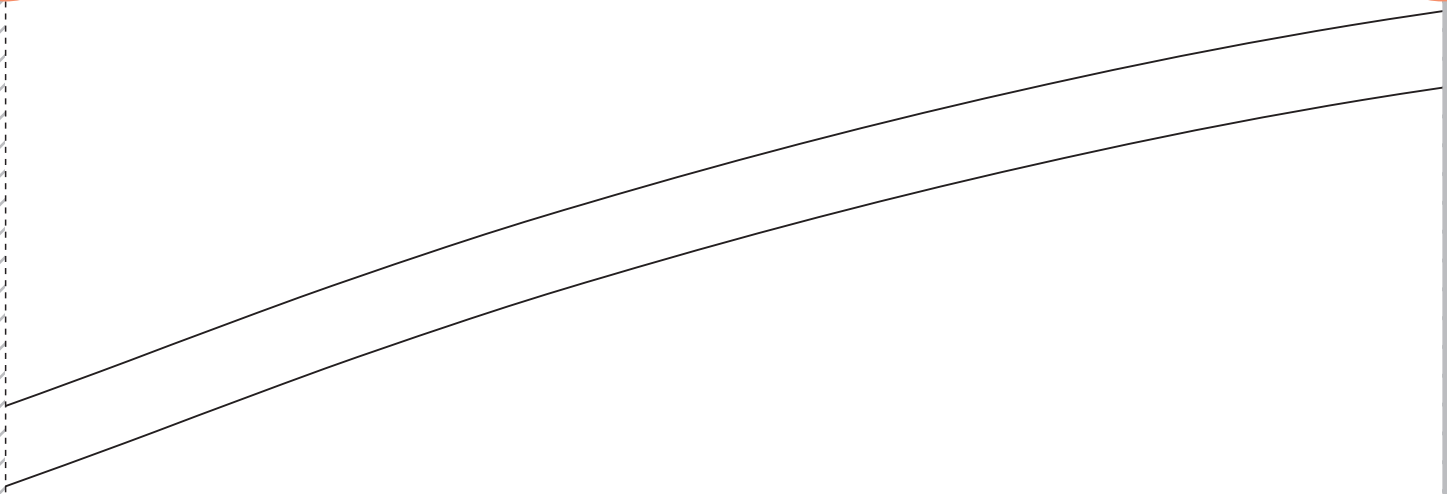
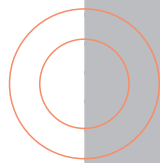
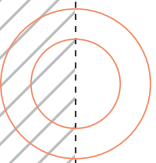
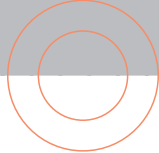

16

ロック片倒し(後高)

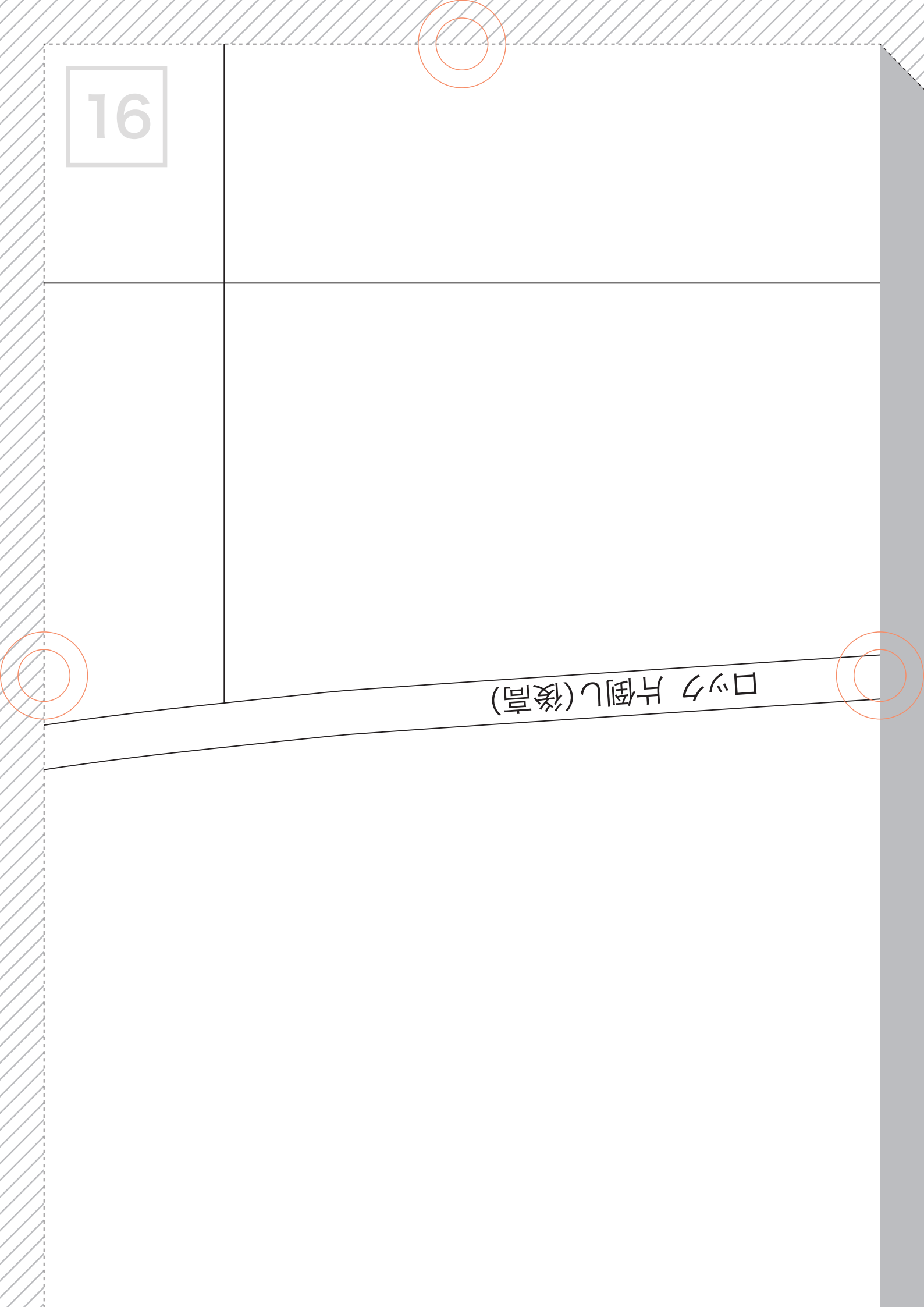

17

地の目線

0.1

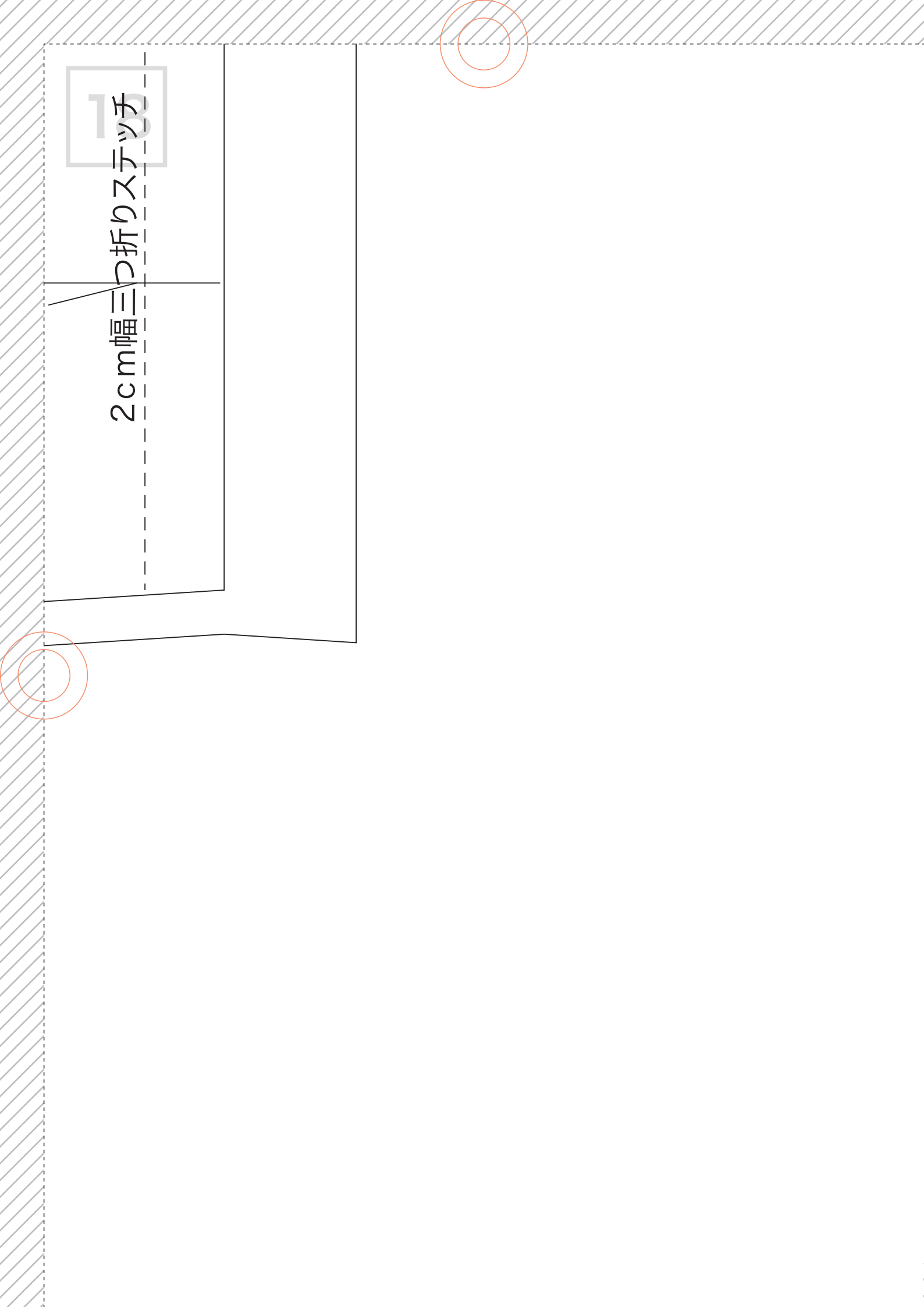

2cm幅三つ折りステッチ

13

19

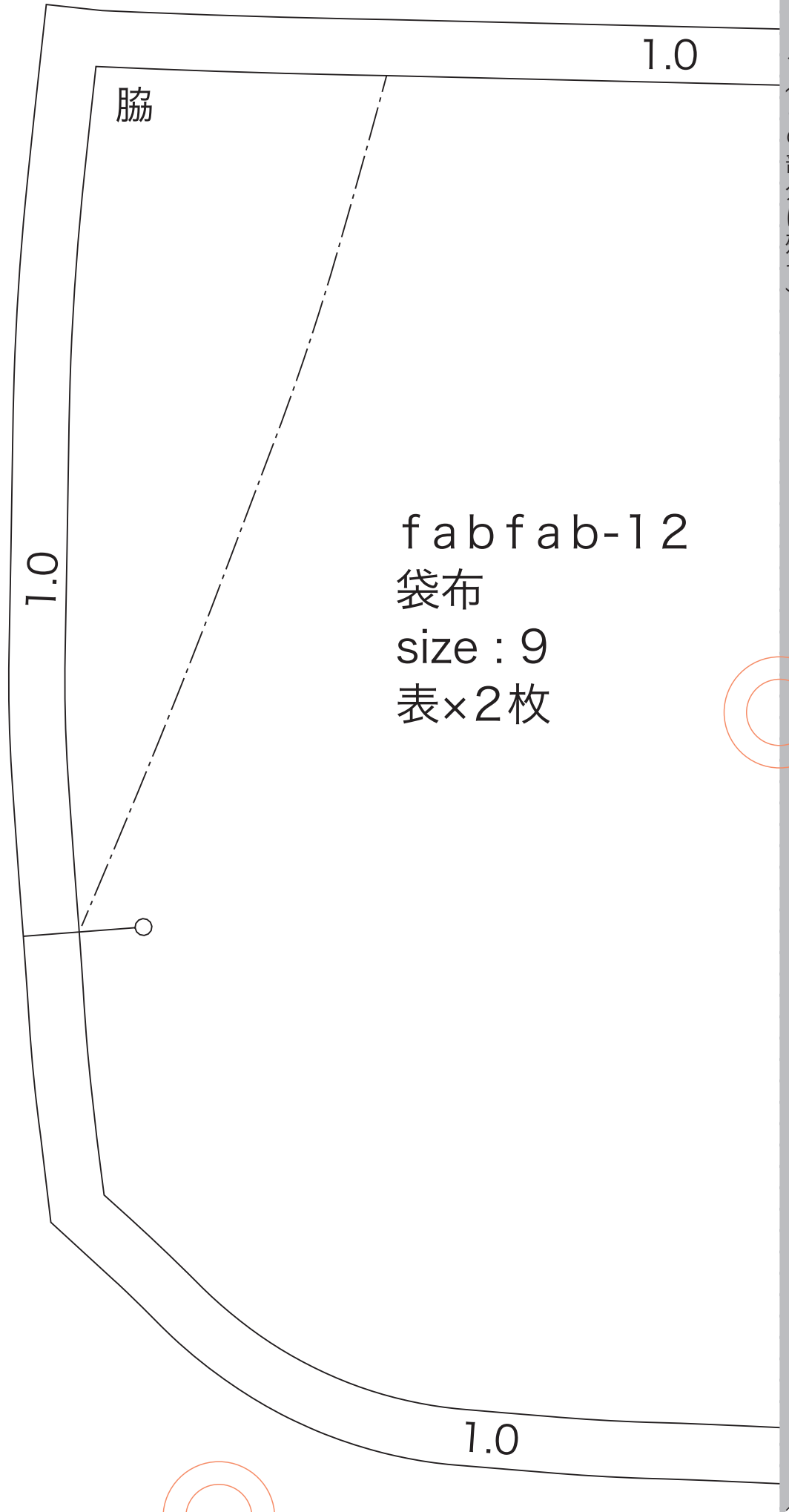

切り取る (斜線部はカット)

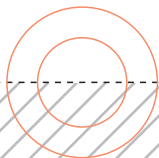

20

1.0

折山線

地の目線

前パンツポットロと接ぐ

ロック

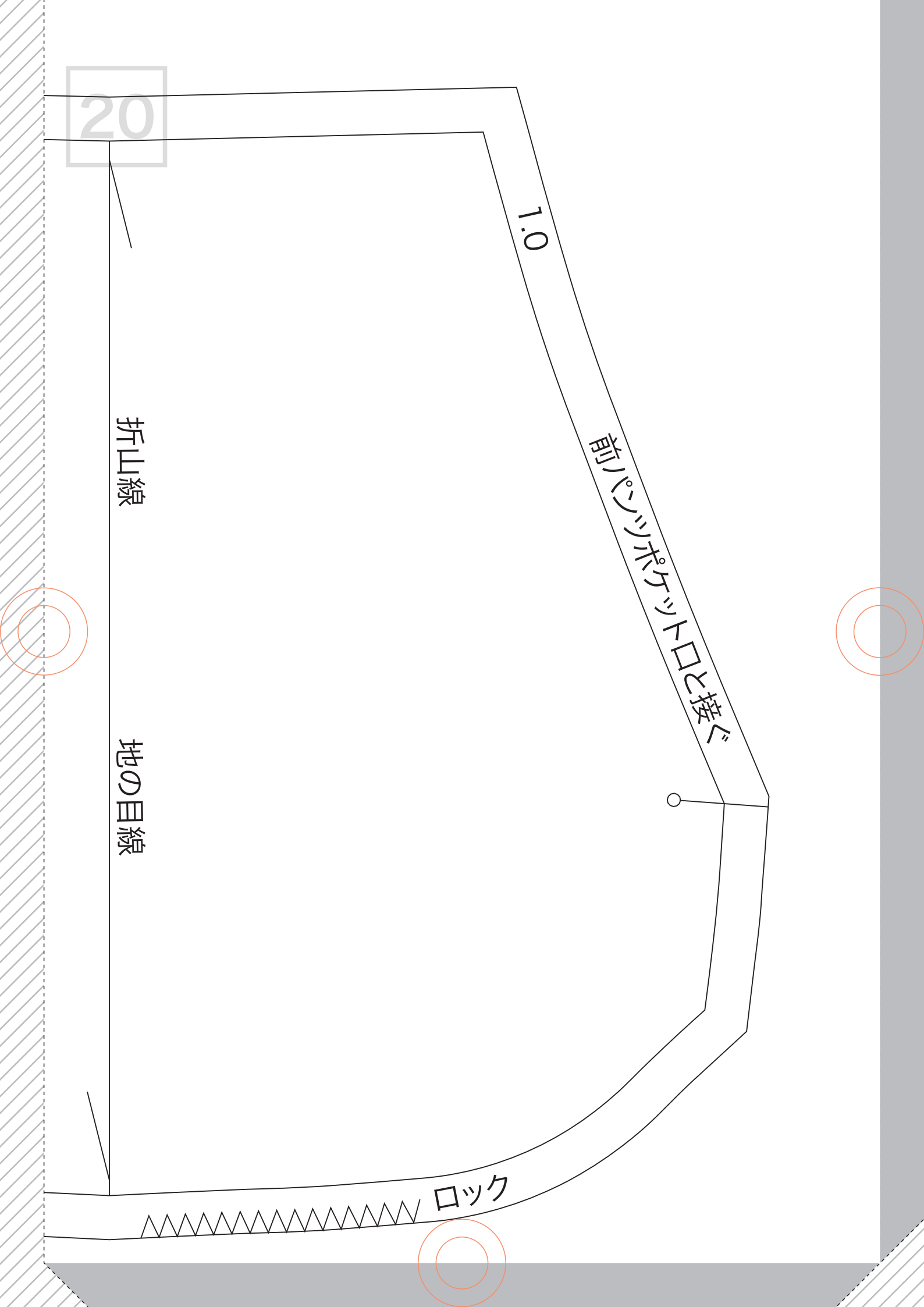

21

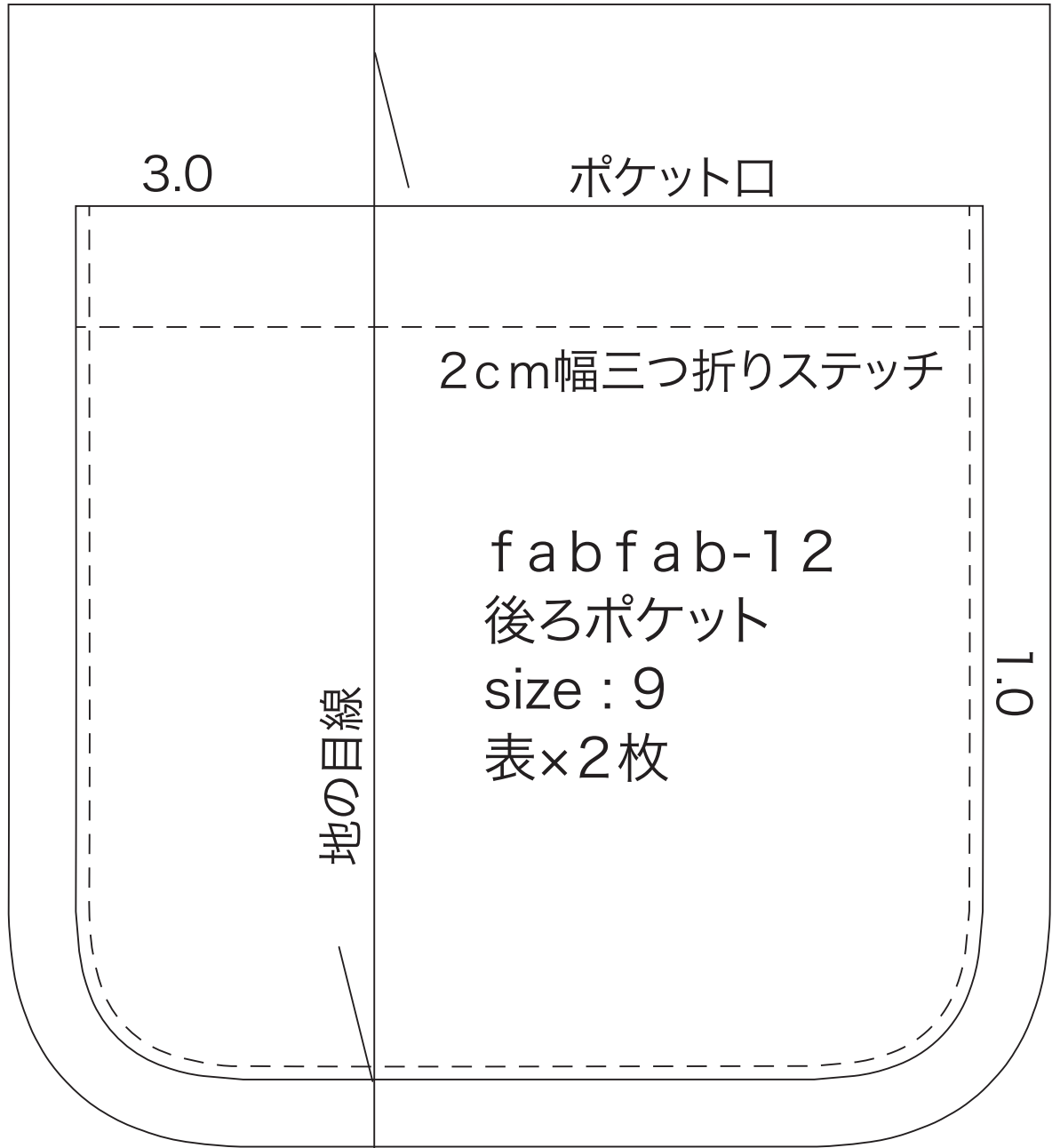

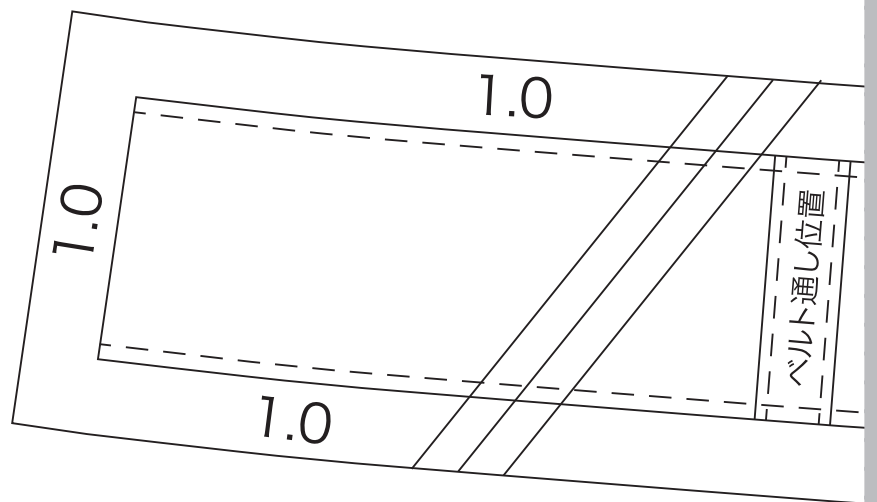
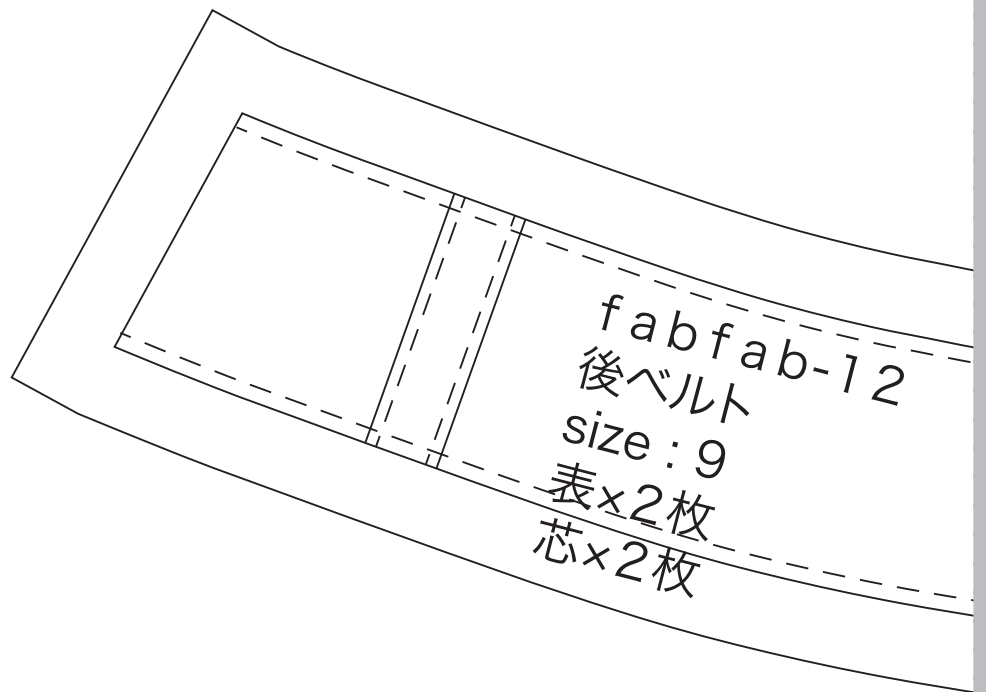

23

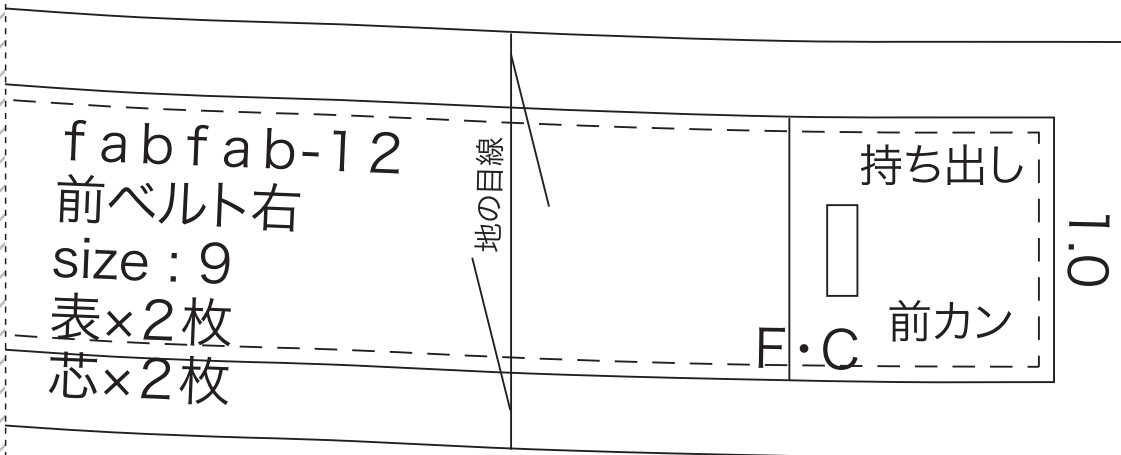
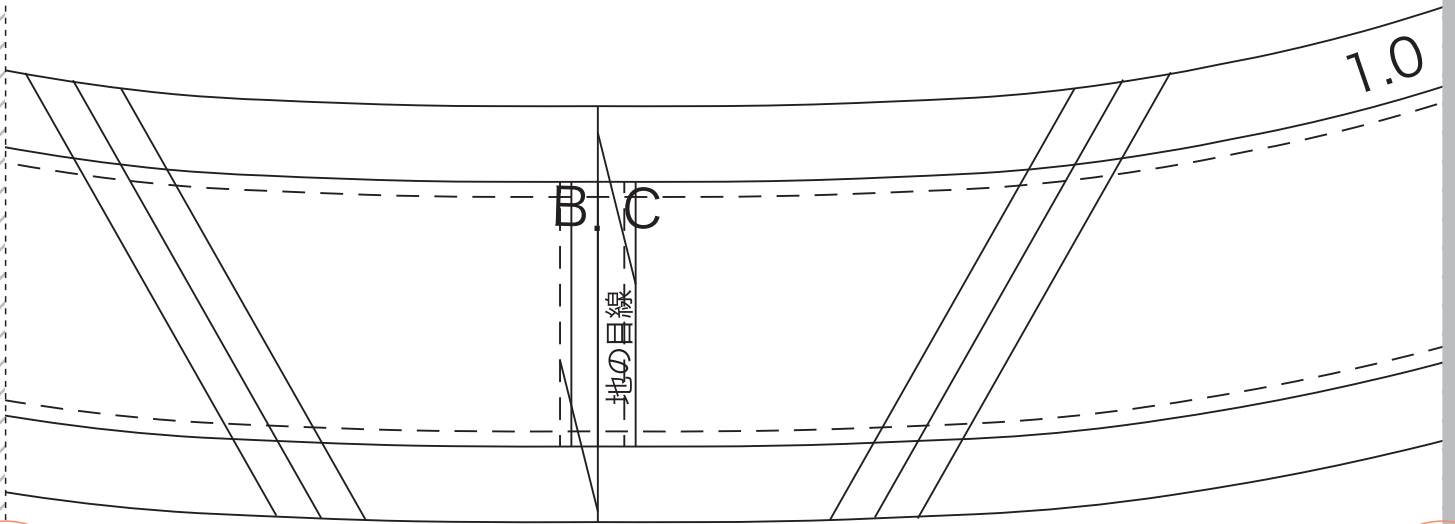

24

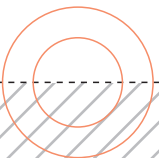
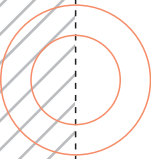
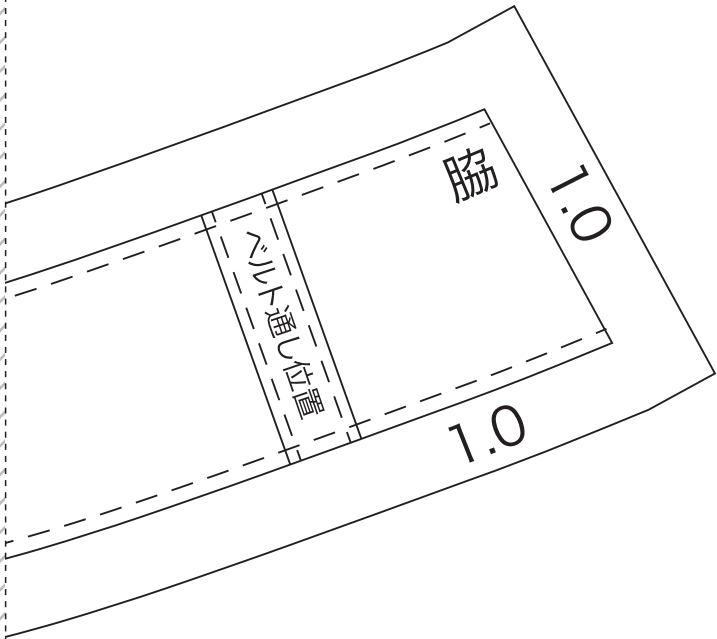

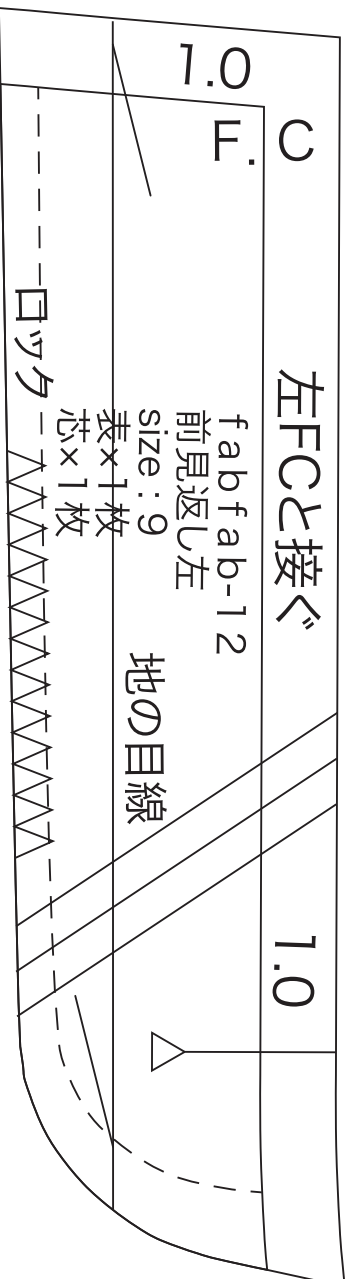
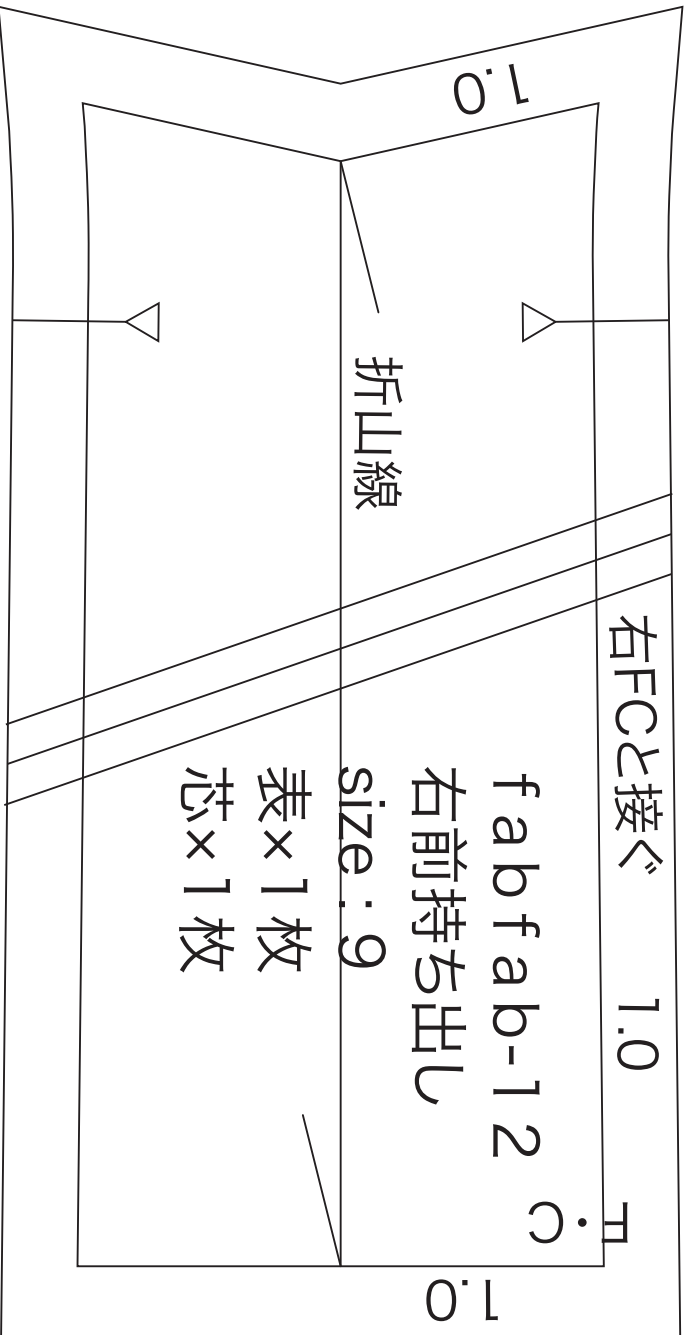

26

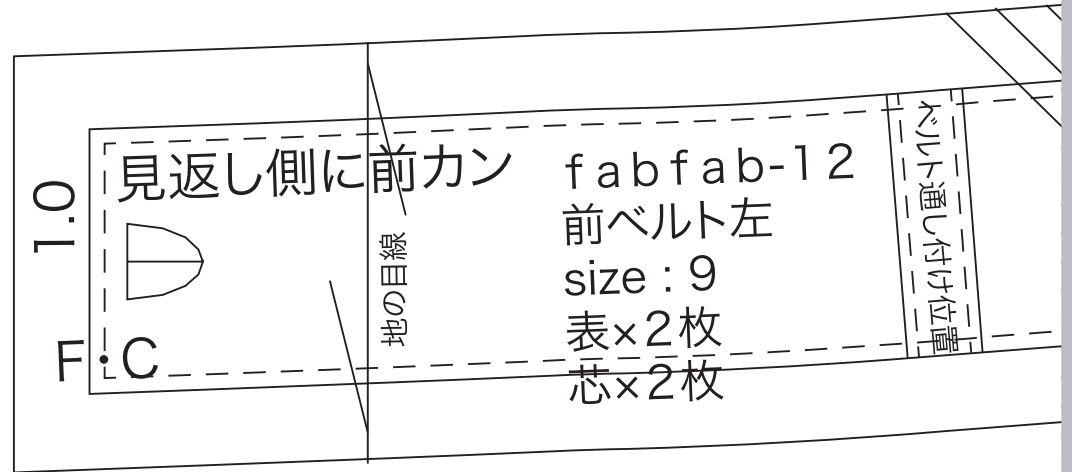

				fabfab-12			
				ベルト通し			
				size : 9			
				表×1枚			

27

