

introduction はじめに

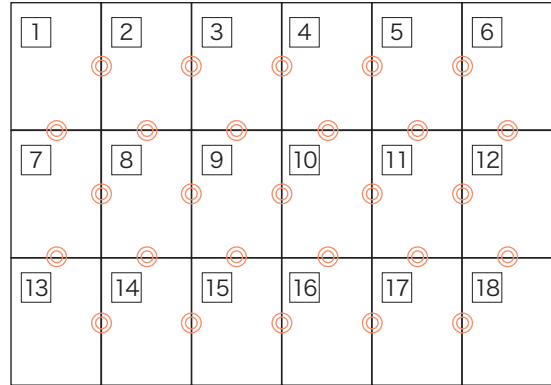

パターンは A4 サイズ 36 枚に分割されています。
印刷後、右図のようにつなぎ合わせてください。

! 印刷時の注意

印刷設定では、「ページの拡大や縮小」を選択せず
必ず、「実際のサイズ」(原寸) で印刷してください。



how to make パターンのつくりかた

STEP1 斜線部分  は切り取り、灰色部分  は残してのりしろにします。
(斜線と灰色を間違えないように注意)

STEP2 各用紙の番号を確認し、 の位置を合わせて、
のりつけします。
(水のりは用紙が波打ちます。スティック糊などをお使いください)

STEP3 それぞれのパーツをハサミで切り出します。

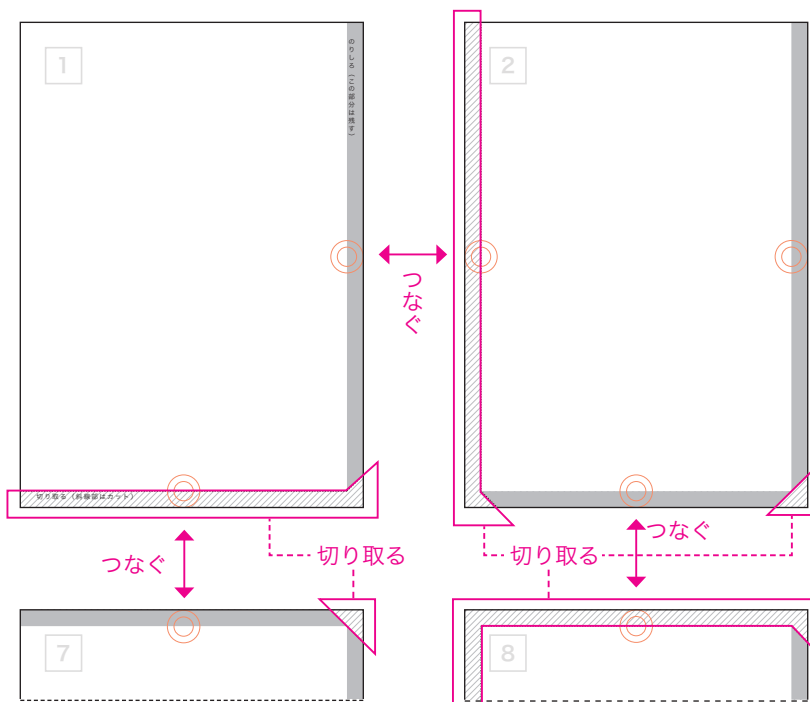
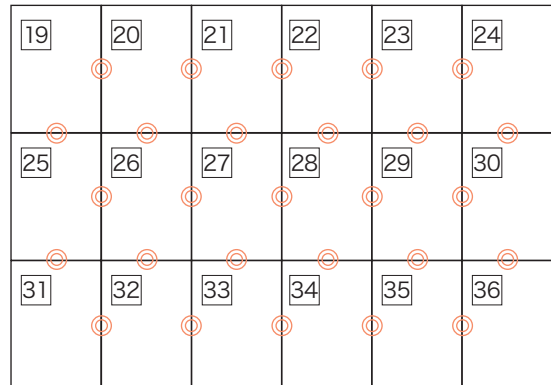

のりしろ (この部分は残す)

1

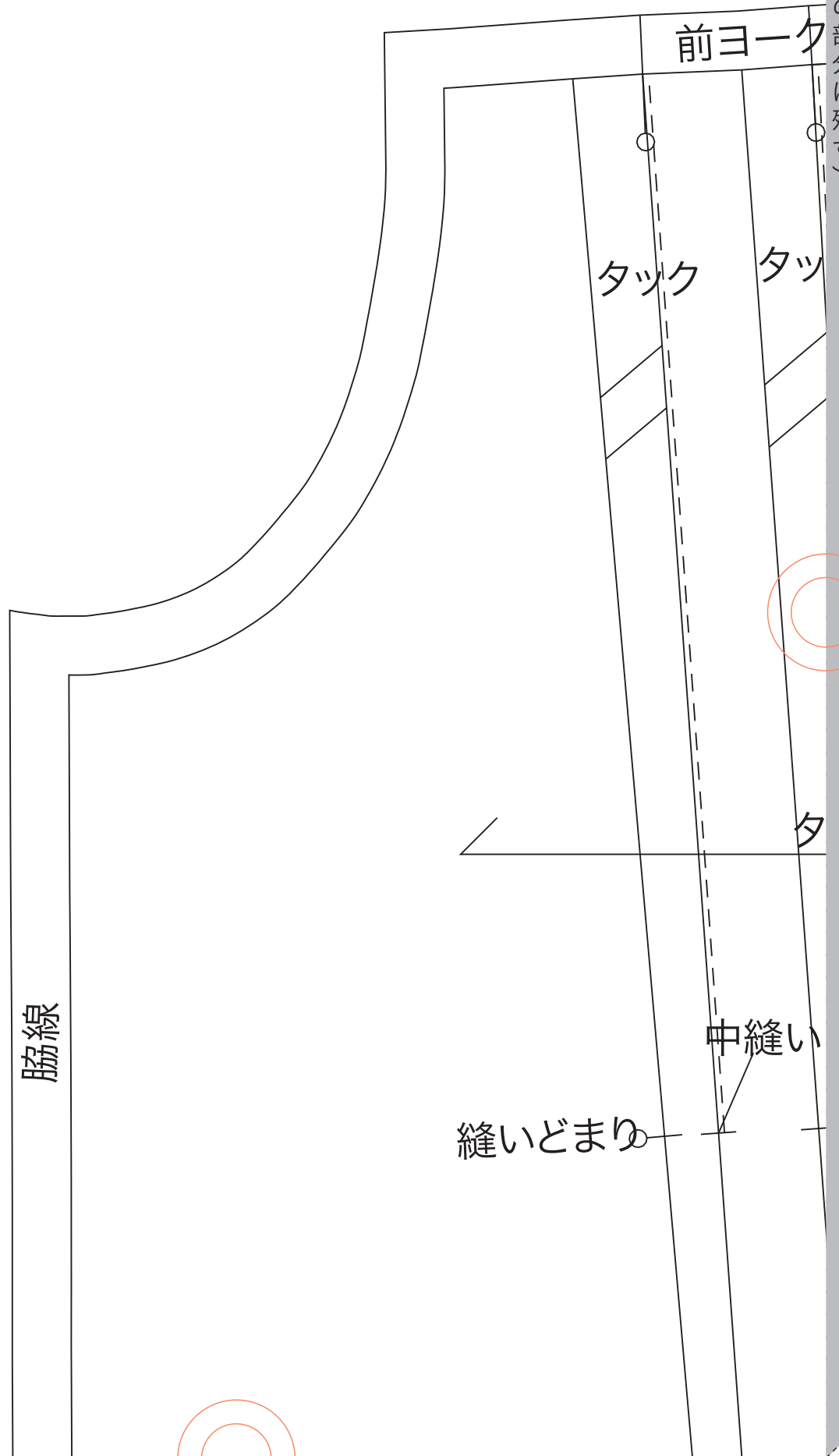

切り取る (斜線部はカット)

2

とはぐ

ク

タック

タック

タック

0.5cm巾ステッチ

共
(釦)

タック倒し方向

切りぬく

中縫い

中縫い

中縫い

中縫い

縫いどまり

F. C

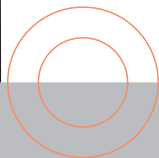
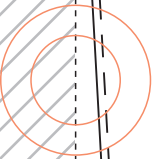

3

1.0

布ループ
(=12mm)

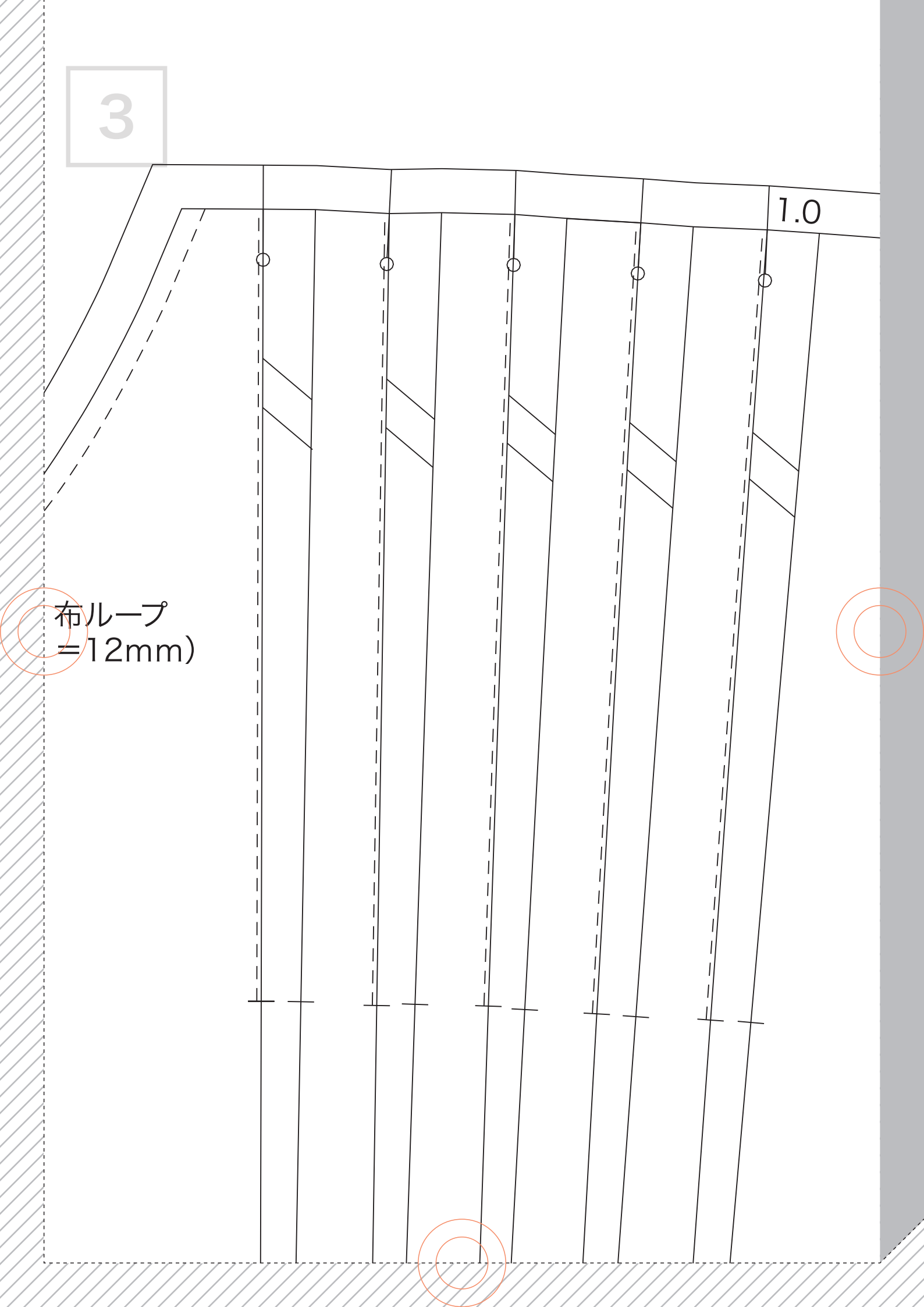

4

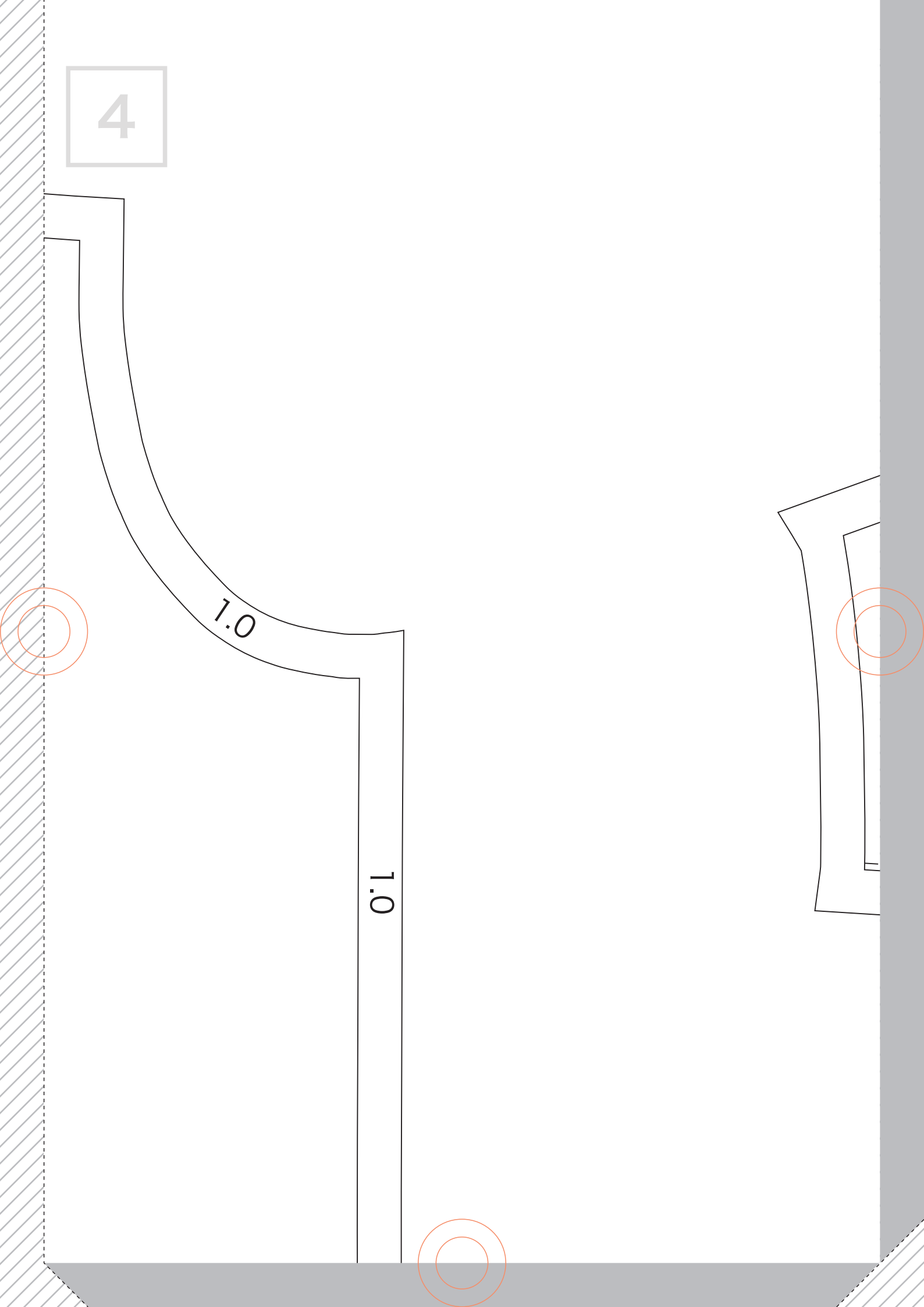

5

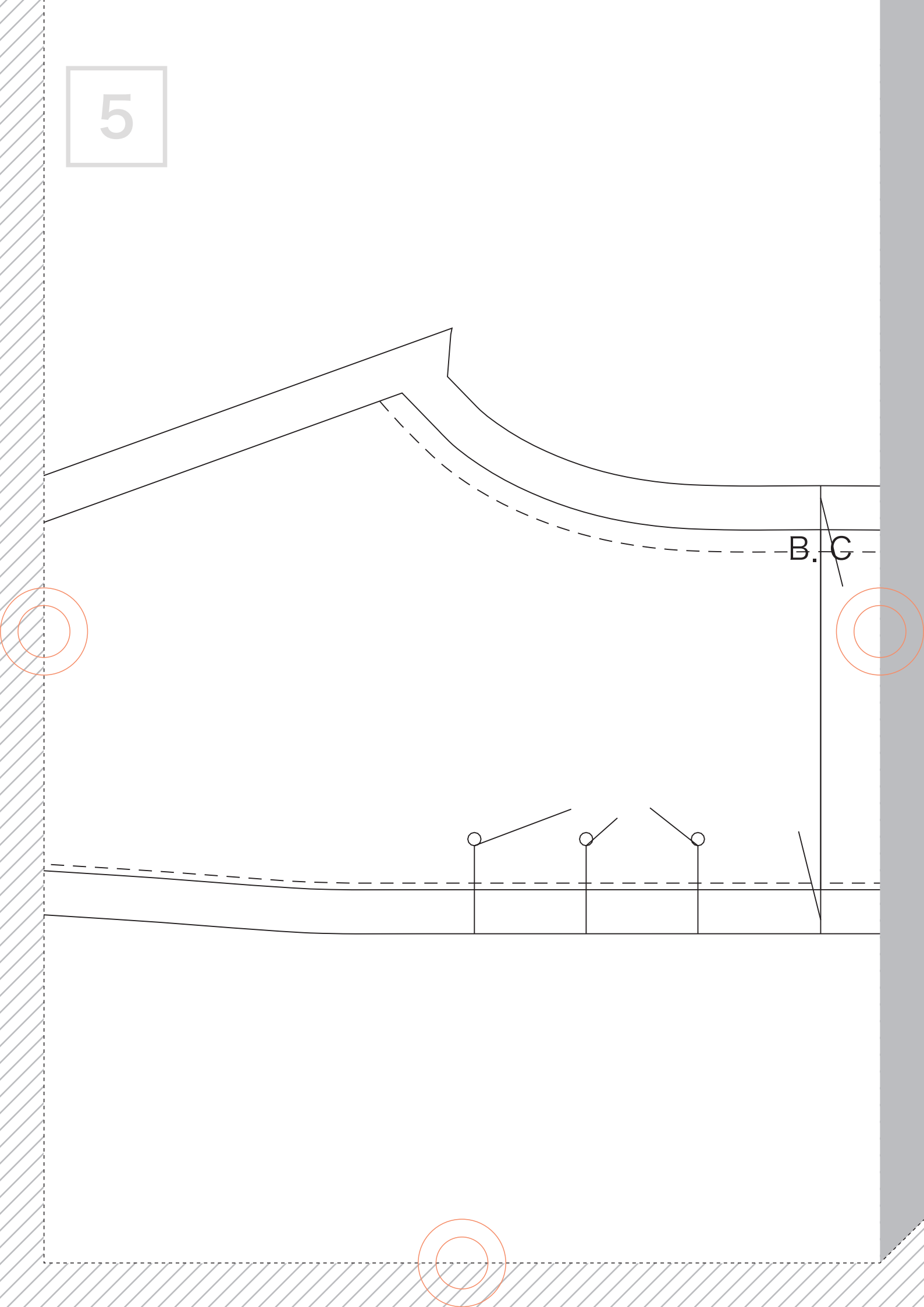

6

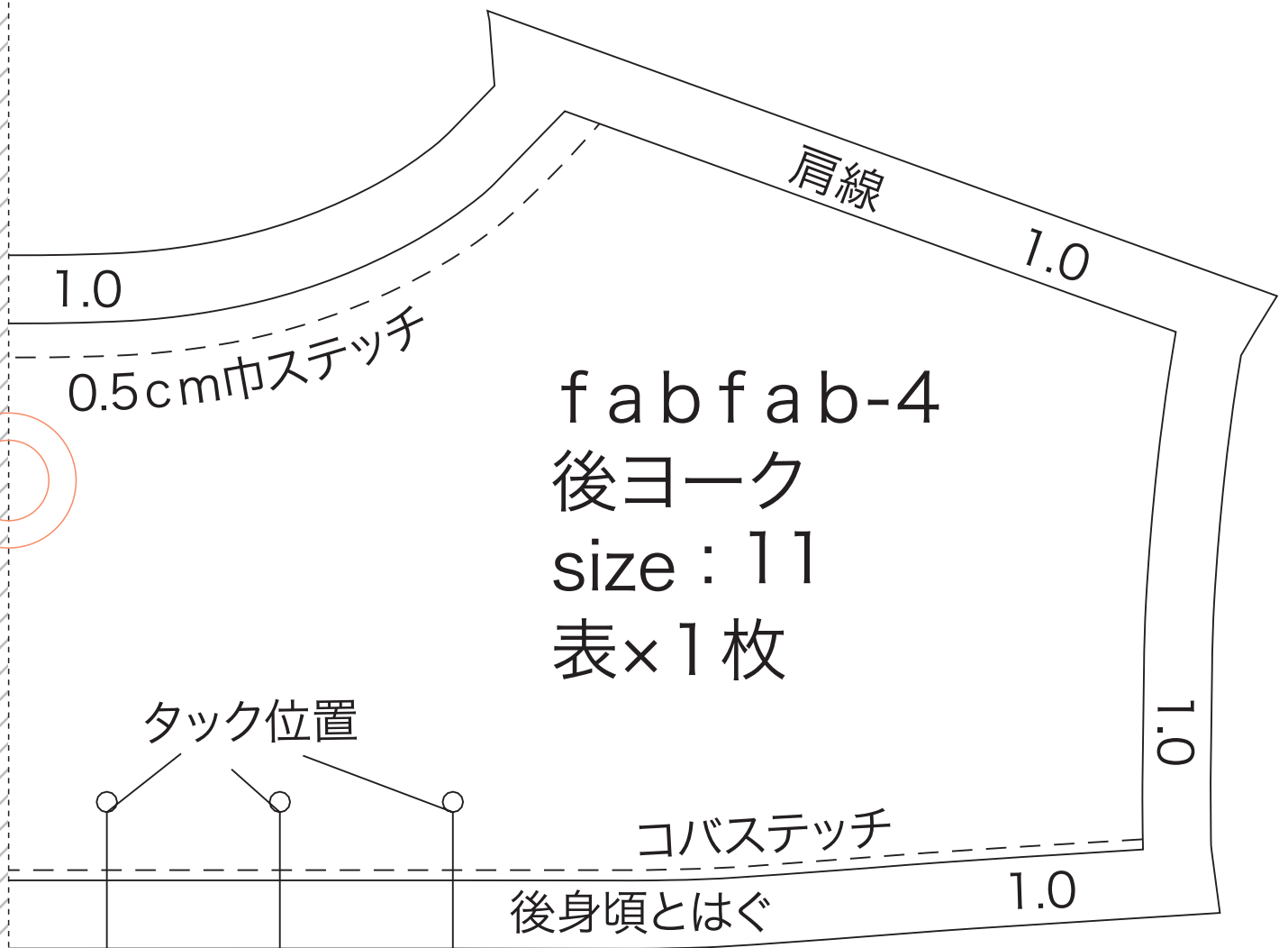

1.0

0.5cm巾ステッチ

肩線

1.0

fabfab-4

後ヨーク

size : 11

表 x 1枚

タック位置

コバステッチ

1.0

後身頃とはぐ

1.0

7

糸ループ 付く

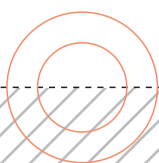
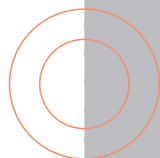
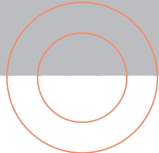

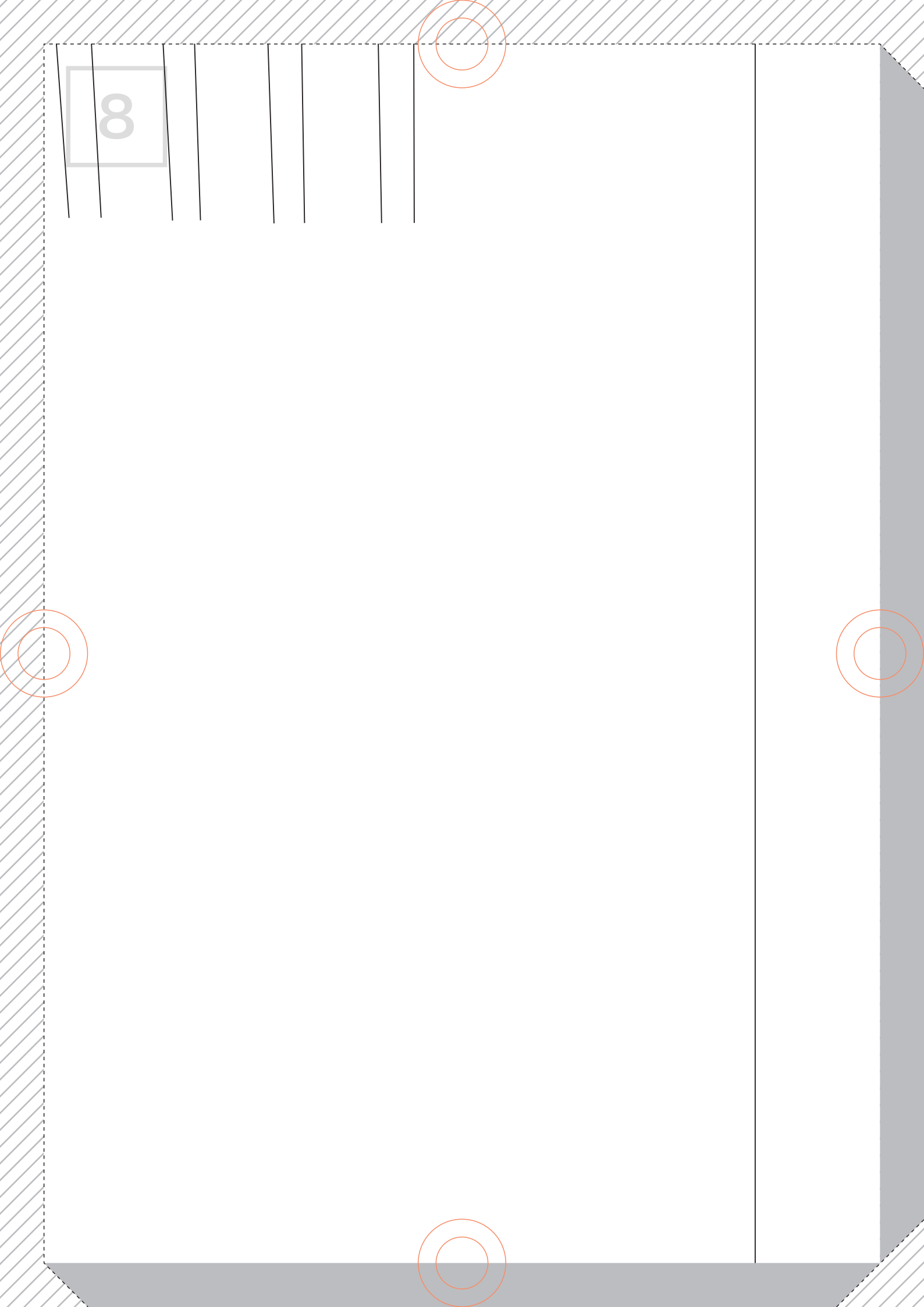

8

9

f a b f a b-4

前身頃

size : 11

表×1枚

10

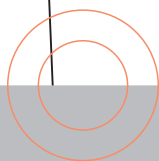
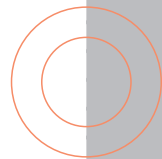
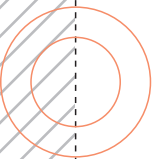
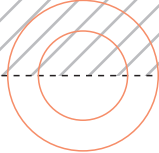

11

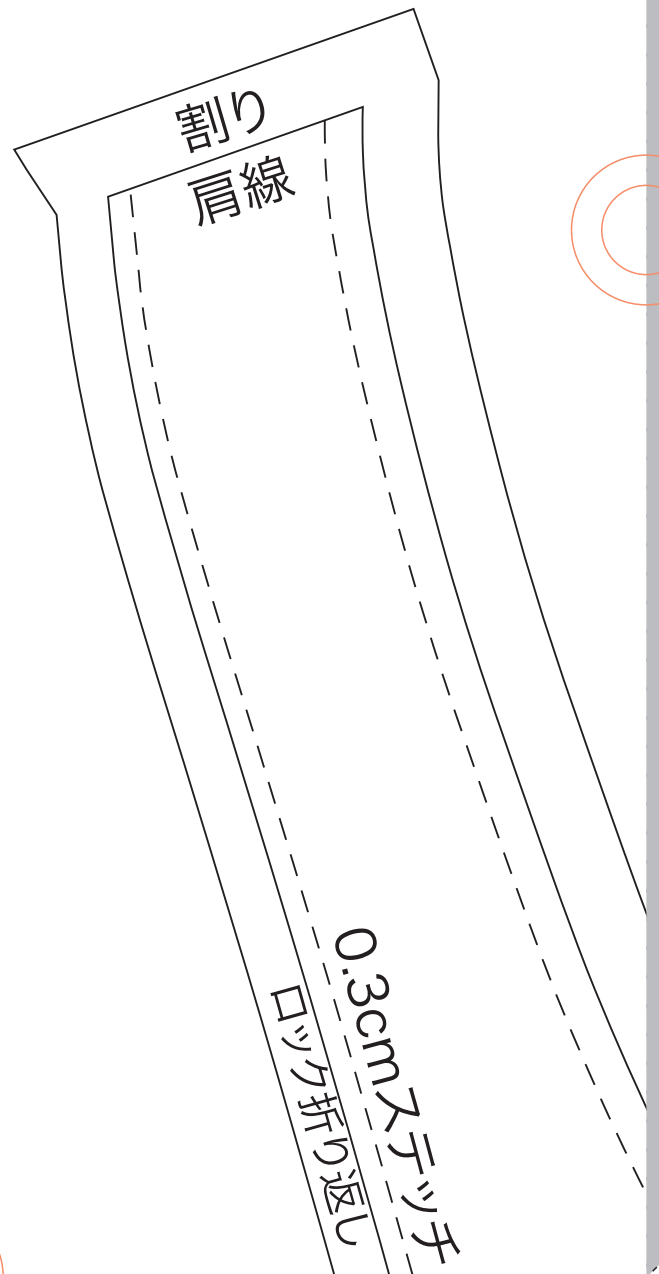

12

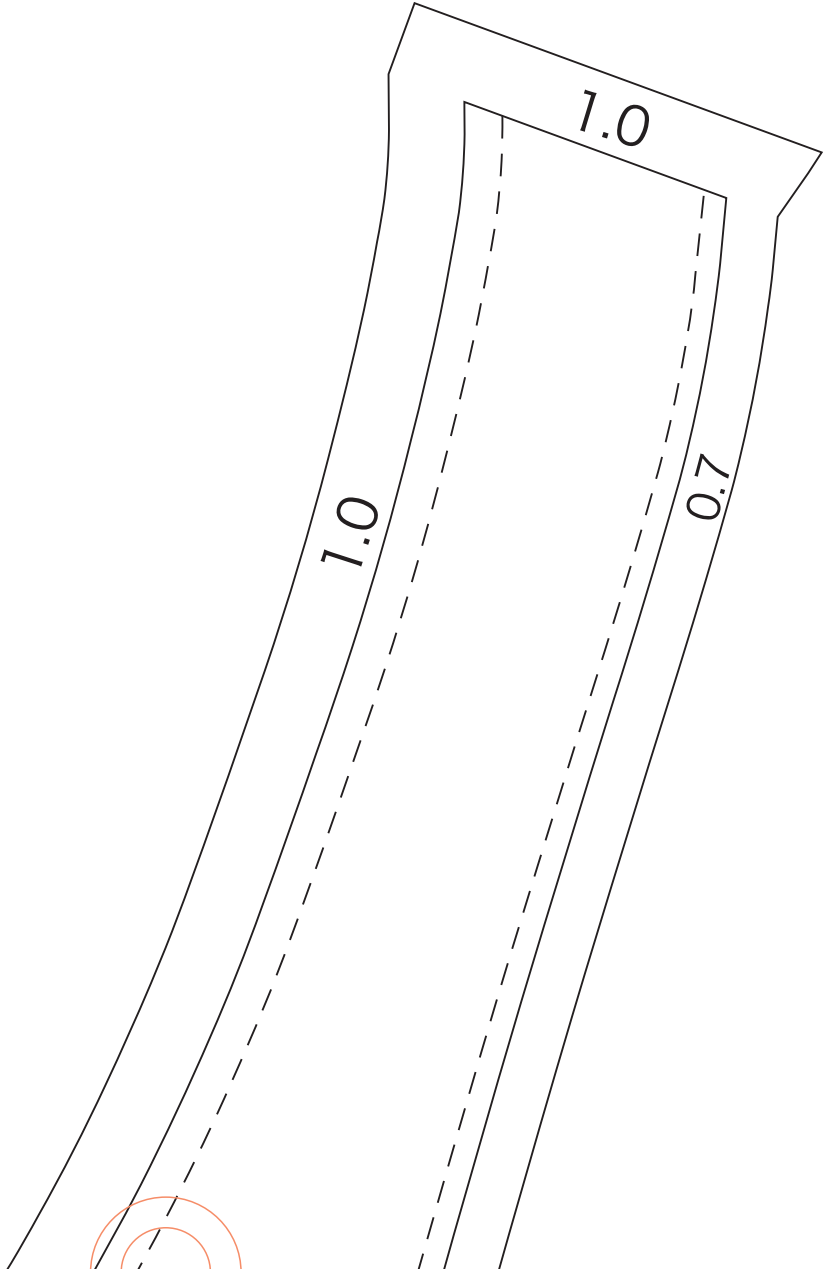
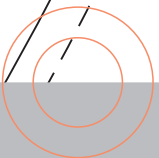
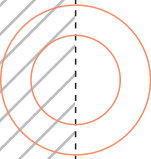
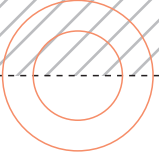

13

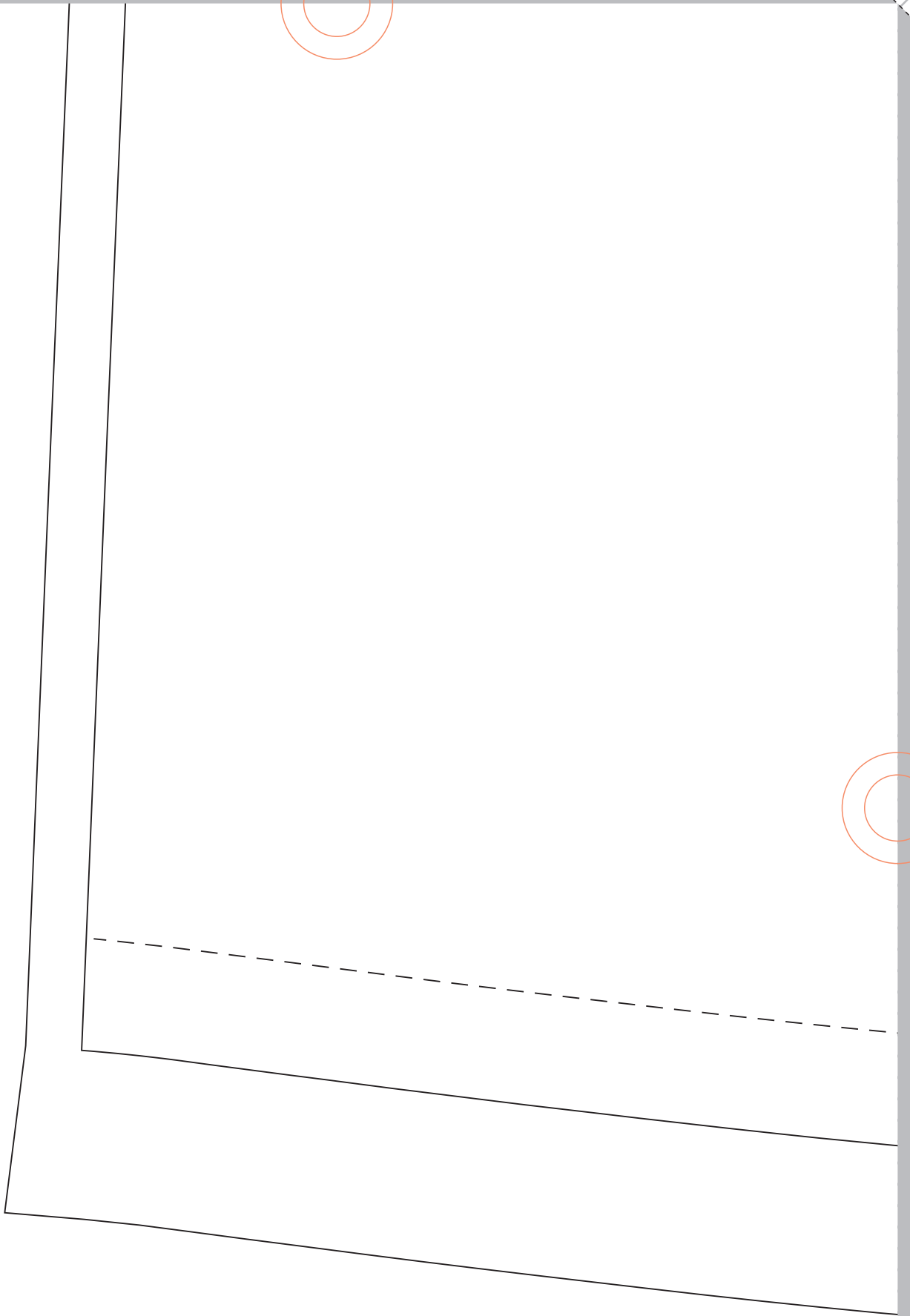
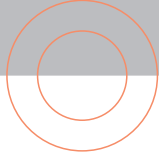

14

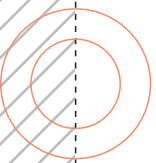
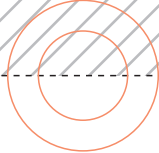

3つ折りして2cm幅ステッチ

裾出来上がり線

15

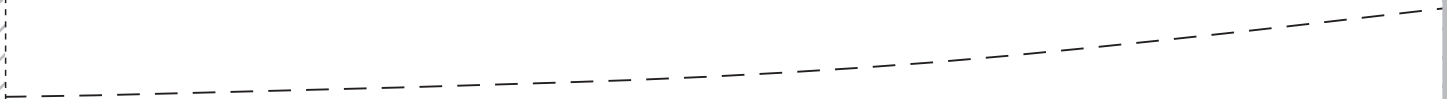
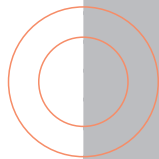
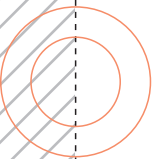
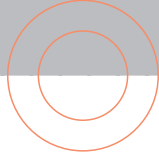

3.0

16

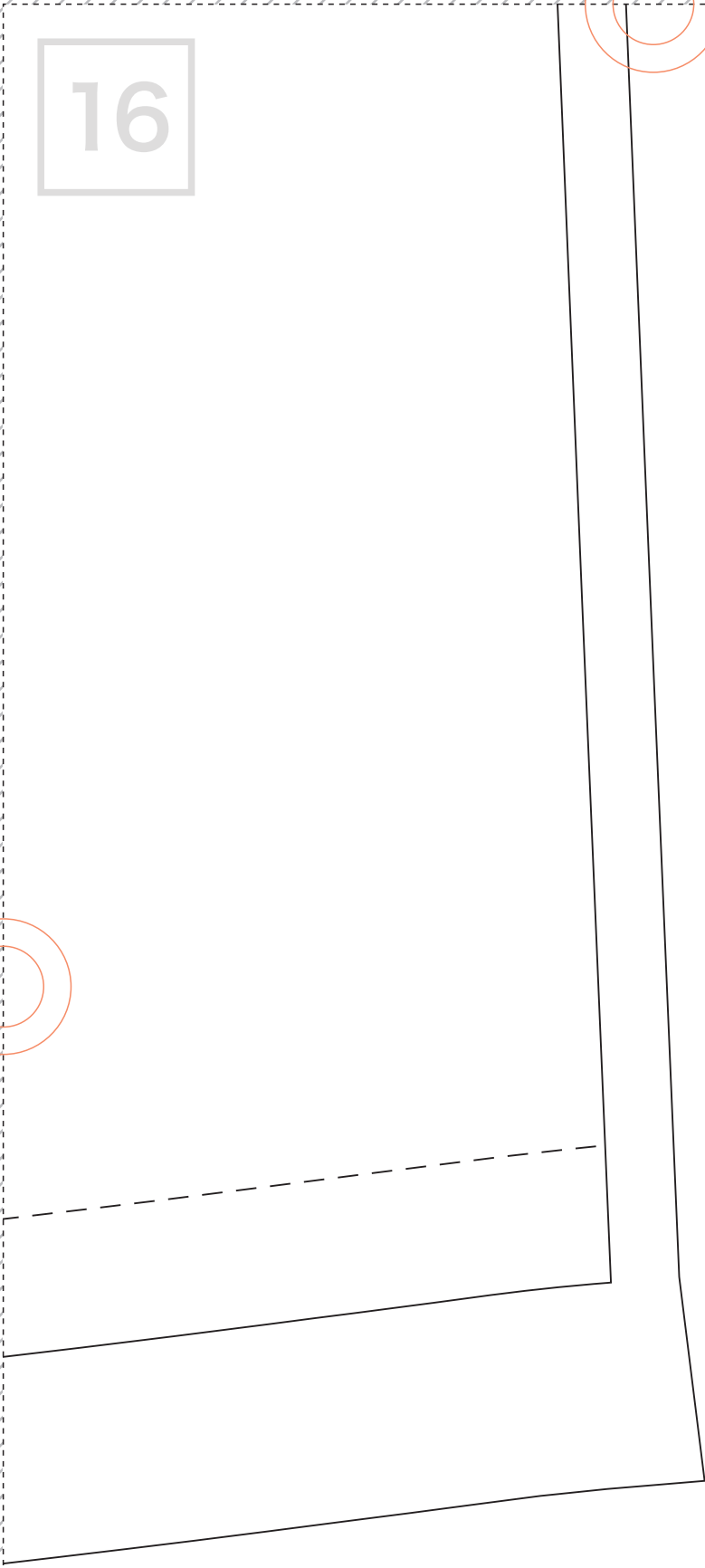
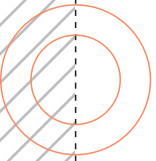
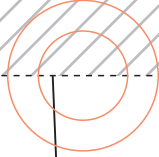

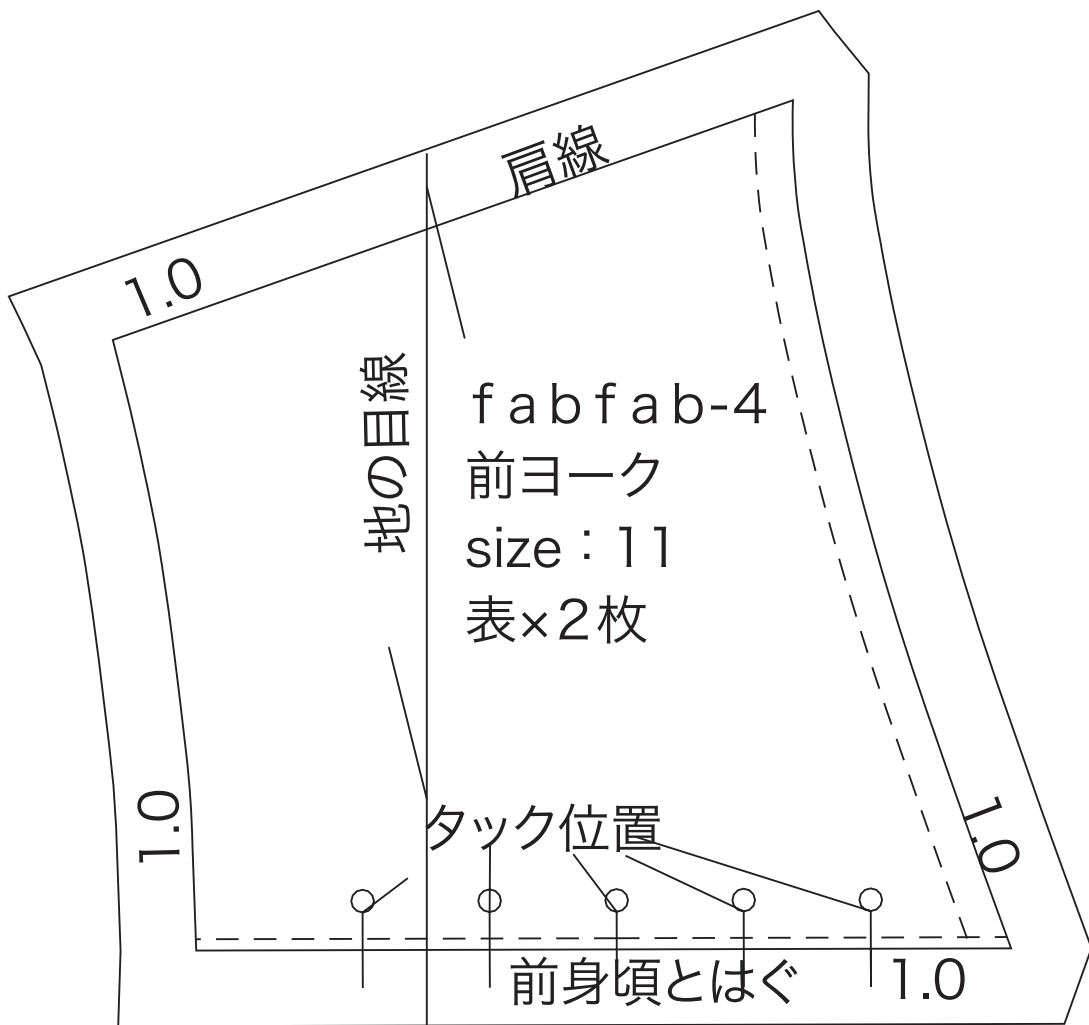

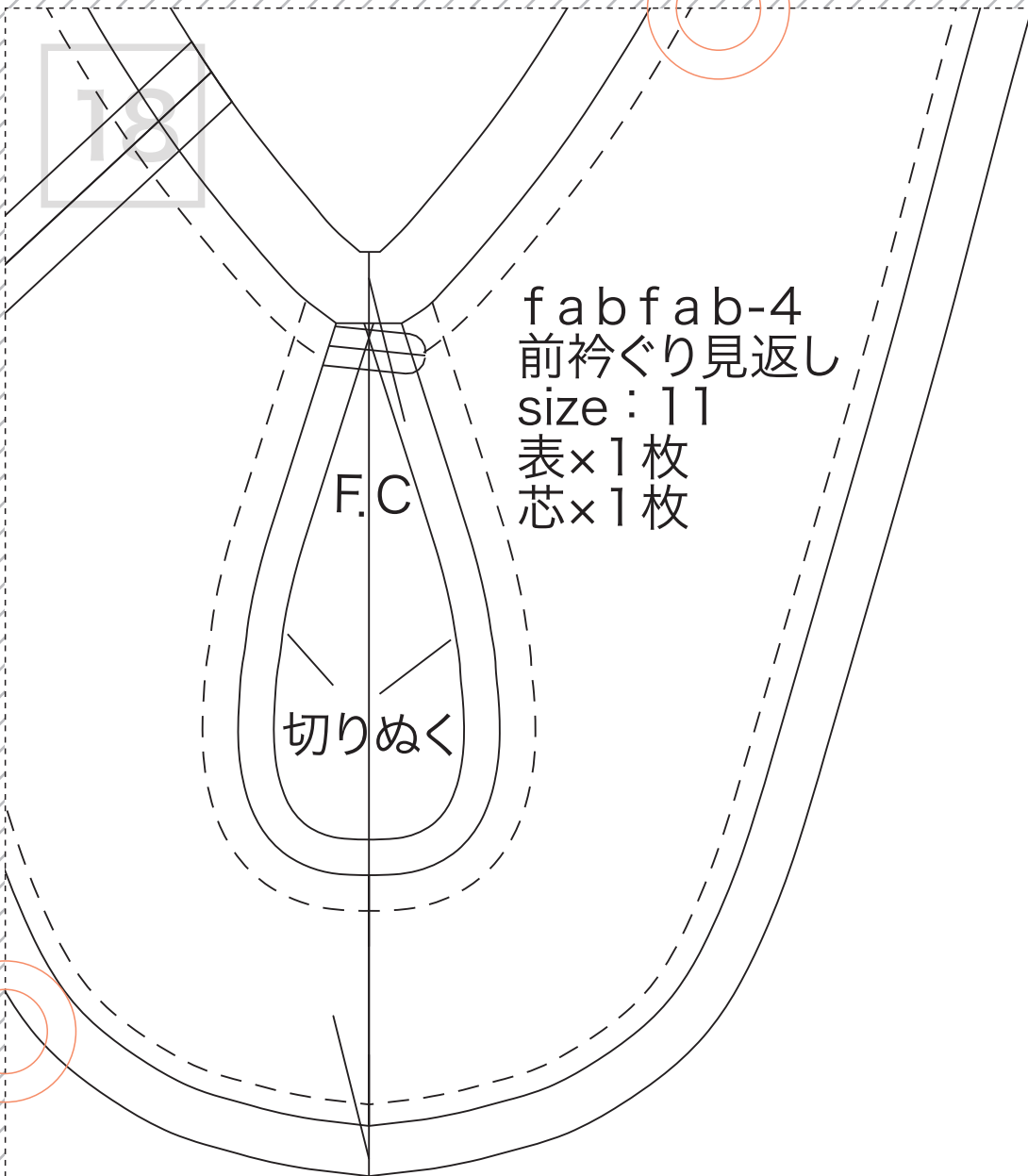

f a b f a b - 4
前衿ぐり見返し
size : 11
表 × 1 枚
芯 × 1 枚

F.C

切りぬく

18

19

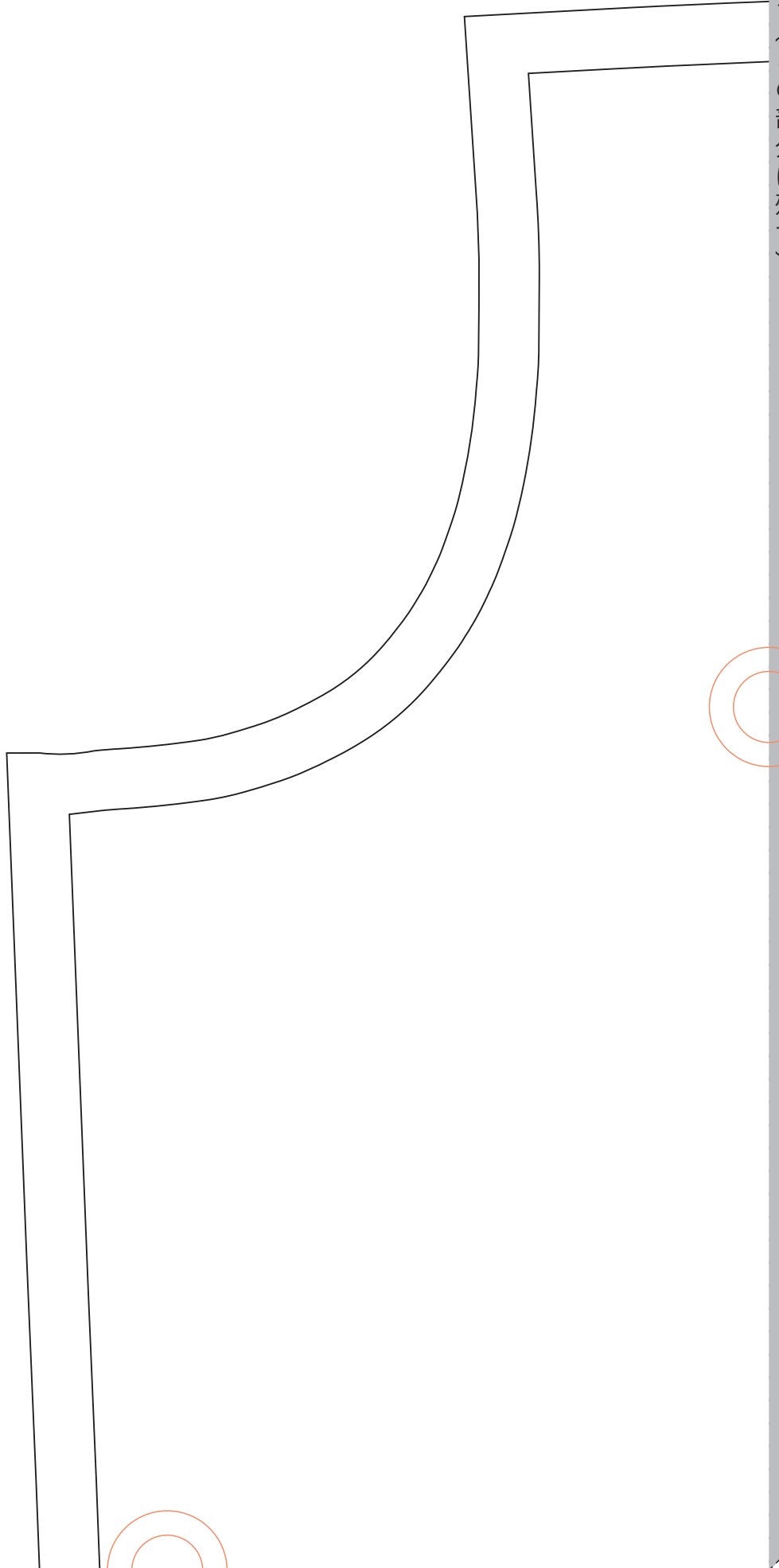

切り取る (斜線部はカット)

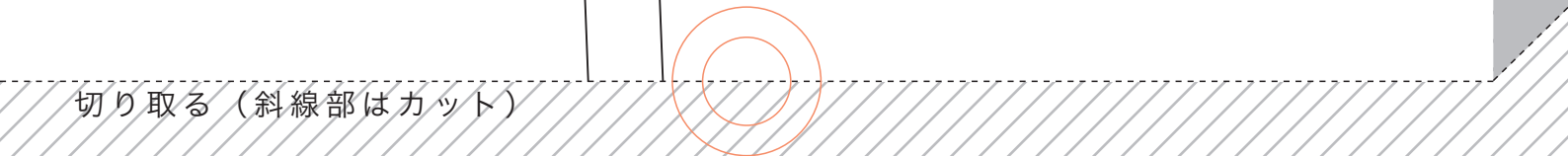

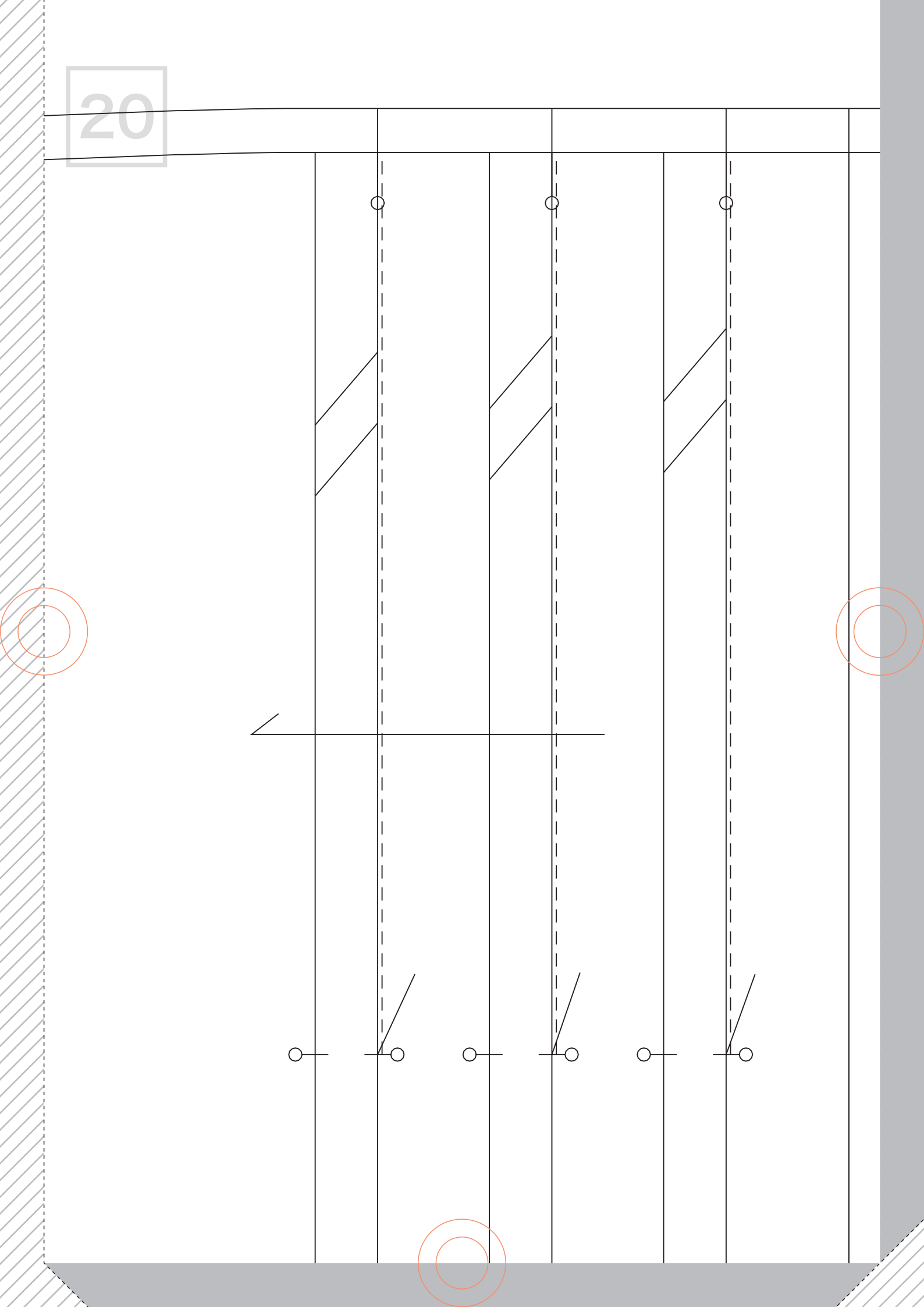

タック

タック

タック

タック倒し方向

中縫い

中縫い

中縫い

縫いどまり

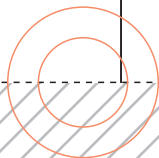
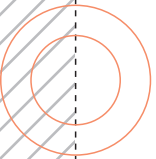

22

1.0

1.0

脇線

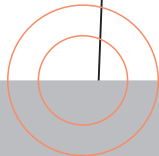
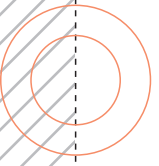

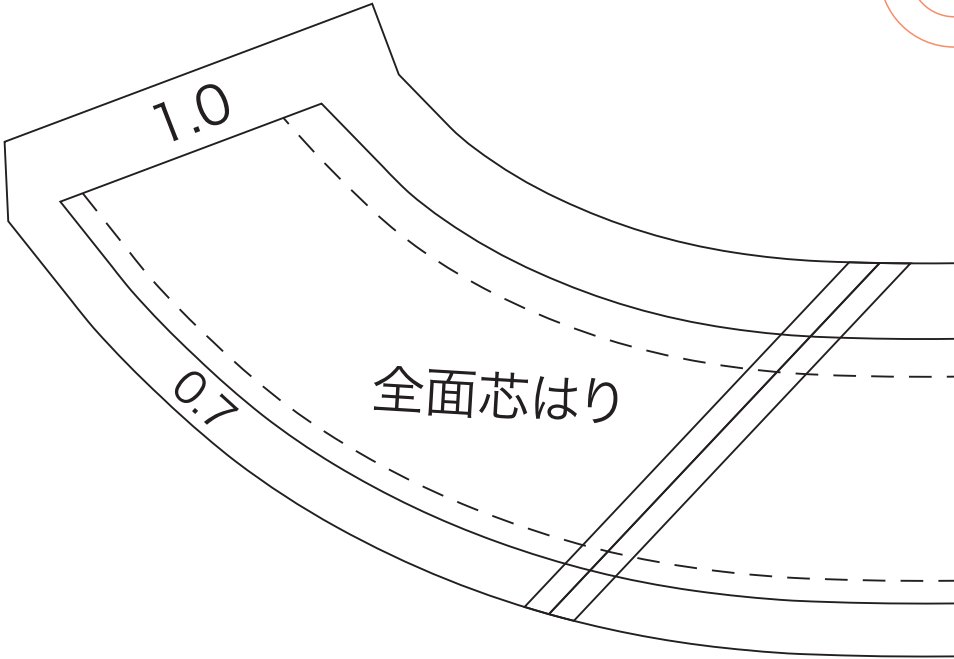
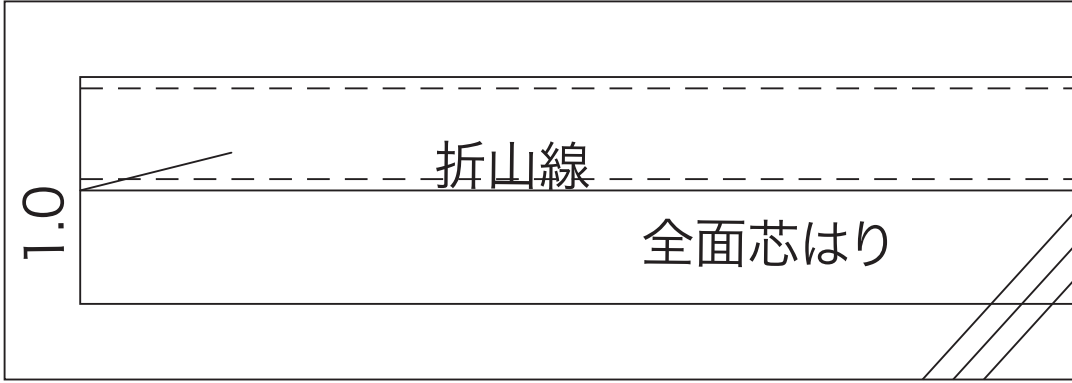

24

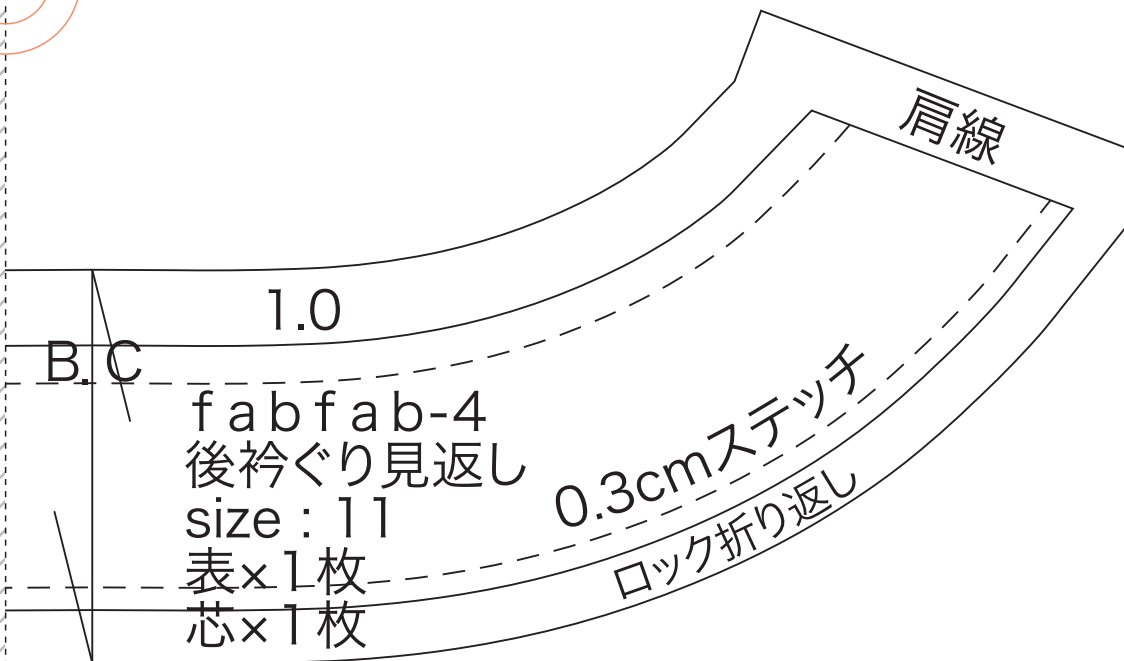
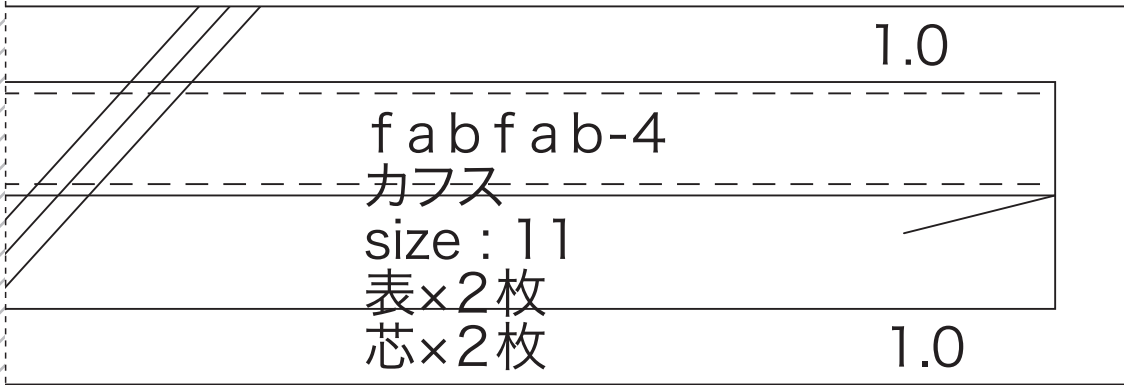

25

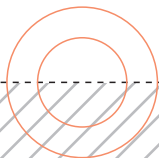
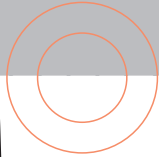
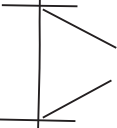
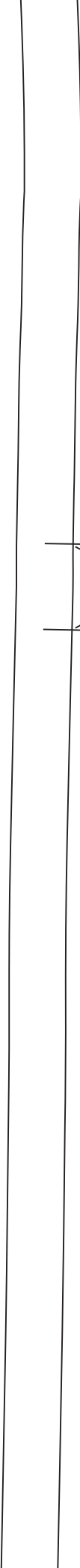

26

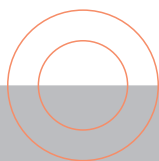
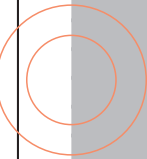
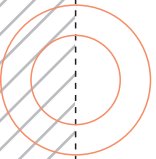
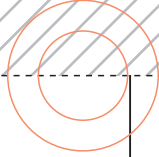

27

f a b f a b-4

後身頃

size : 11

表×1枚

28

糸ループ 付く

袖下

後ろ

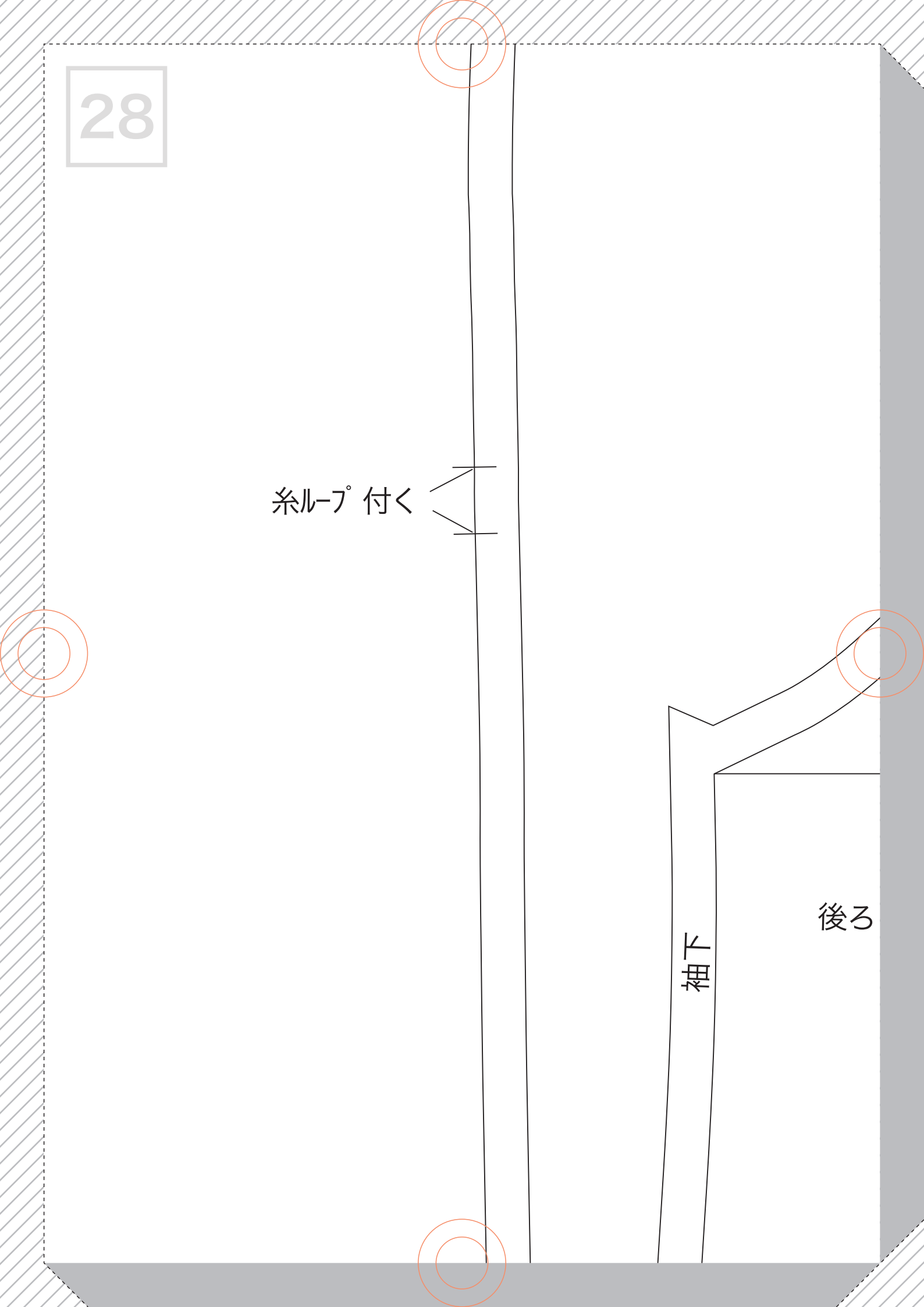

29

袖山

f a b f a b - 4

袖

size : 11

表 × 2 枚

地の目線

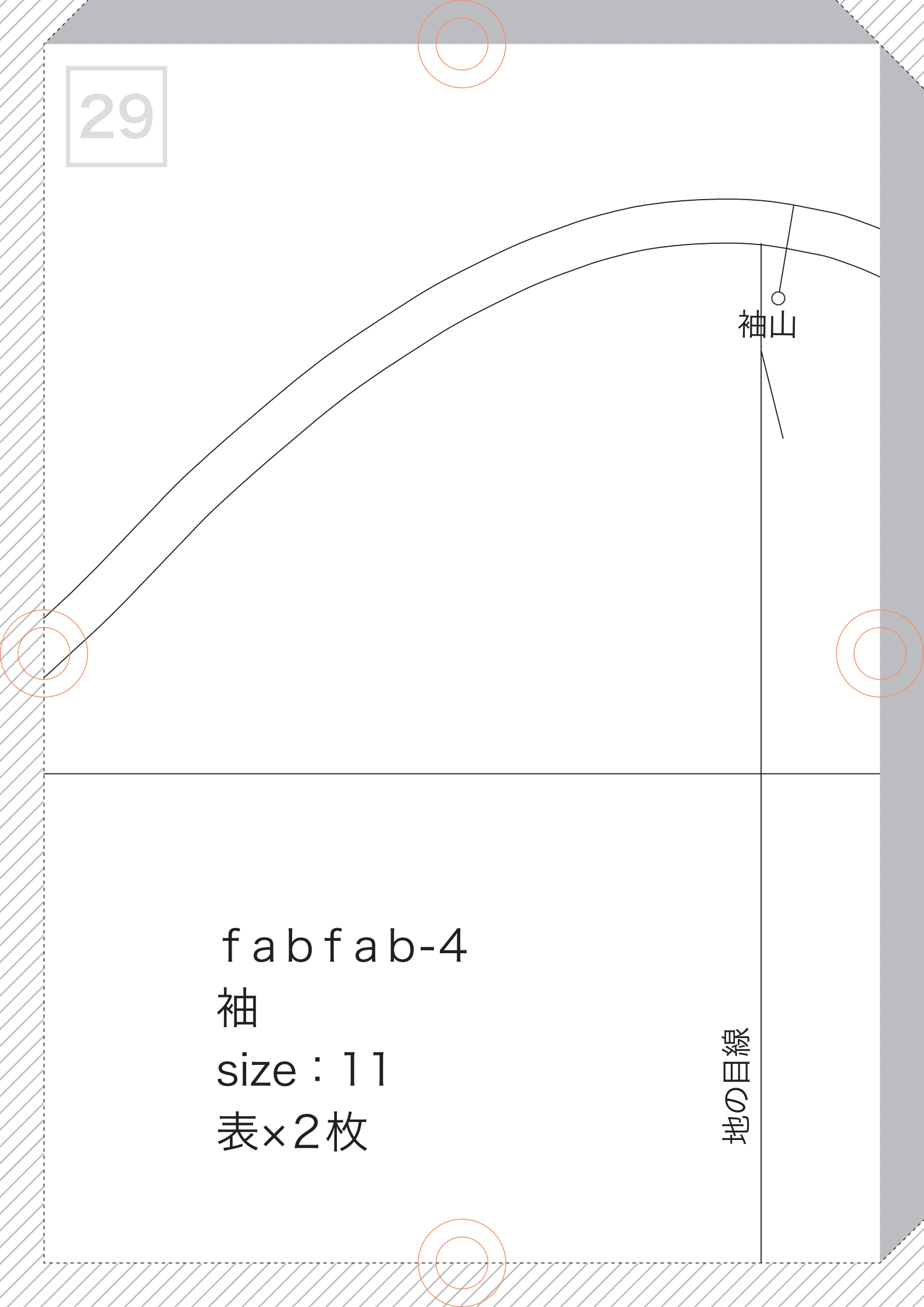

30

	fabfab-4
	ループ
---	size: 11
	表×1枚

1.0

前

台下

31

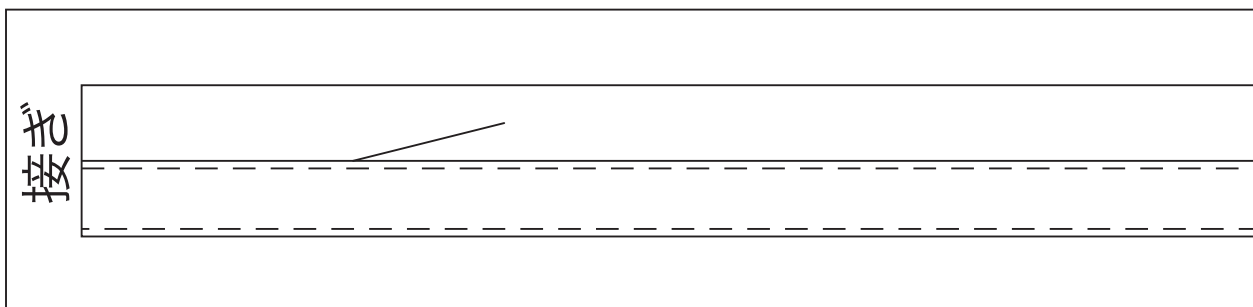
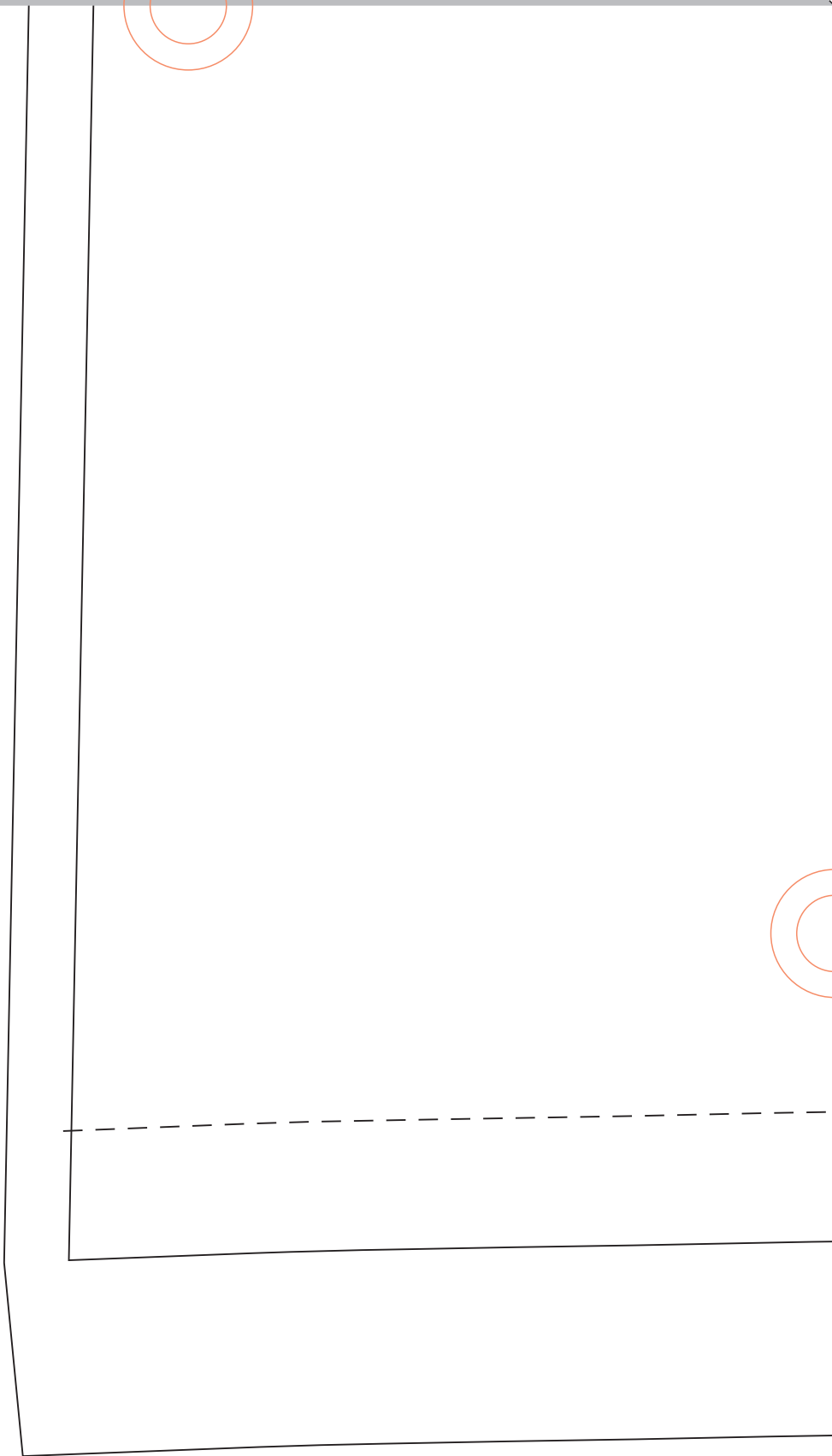
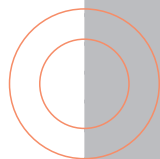
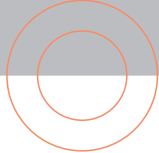

32

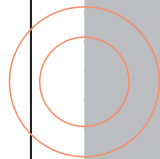
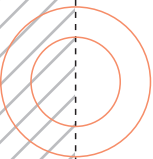
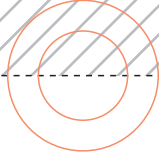

1.0

33

3つ折りして2cm幅ステッチ

裾出来上がり線

3.0

fabfab-4

リボン

size : 11

表×2枚

34

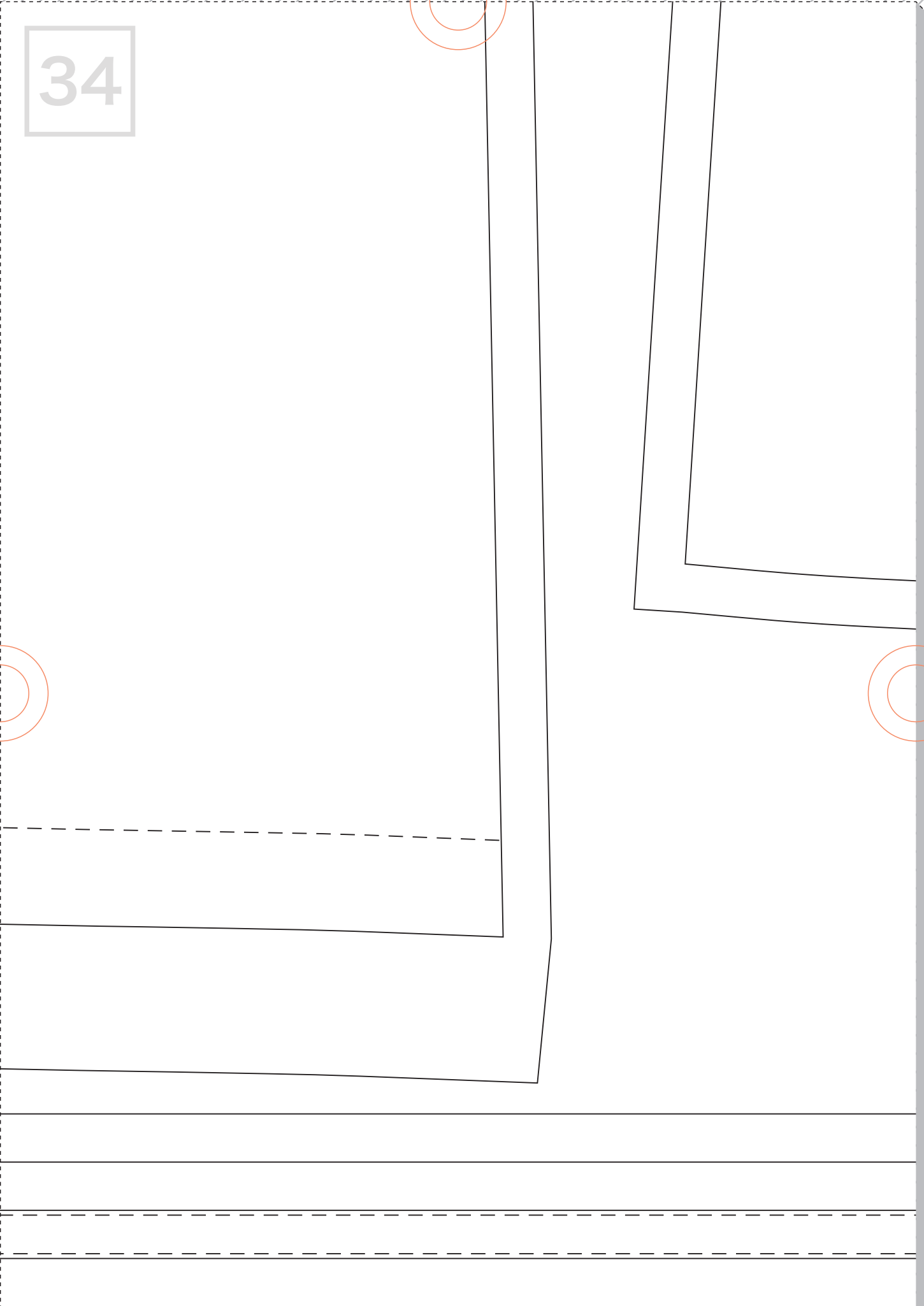
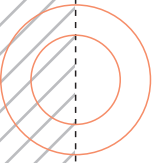
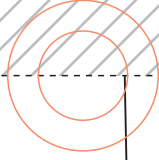

35

ギャザー均等に寄せる

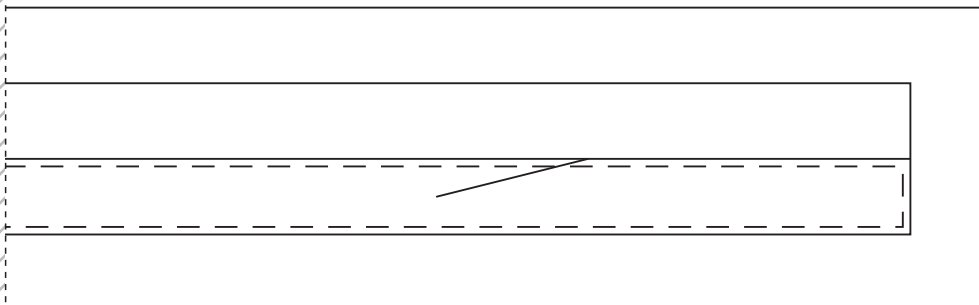
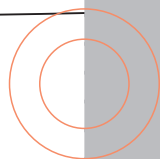
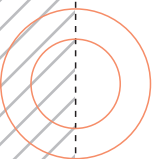

36

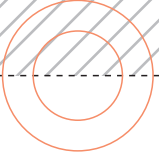

1.0



カフスと接ぐ

1.0

