

introduction はじめに

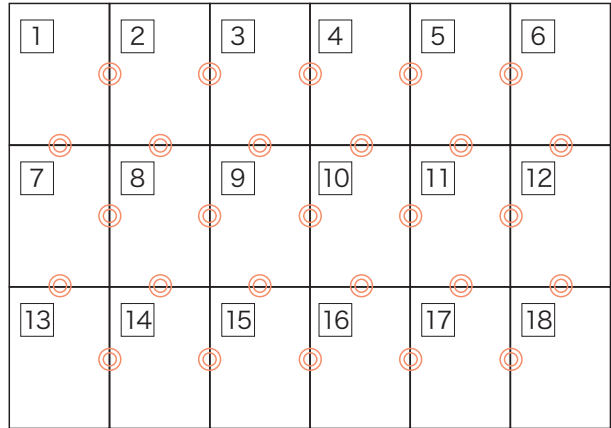

パターンは A4 サイズ 18 枚に分割されています。
印刷後、右図のようにつなぎ合わせてください。

! 印刷時の注意

印刷設定では、「ページの拡大や縮小」を選択せず
必ず、「実際のサイズ」(原寸) で印刷してください。



how to make パターンのつくりかた

- STEP1** 斜線部分  は切り取り、灰色部分  は残してのりしろにします。
(斜線と灰色を間違えないように注意)
- STEP2** 各用紙の番号を確認し、 の位置を合わせて、のりづけします。
(水のりは用紙が波打ちます。スティック糊などをお使いください)
- STEP3** それぞれのパーツをハサミで切り出します。

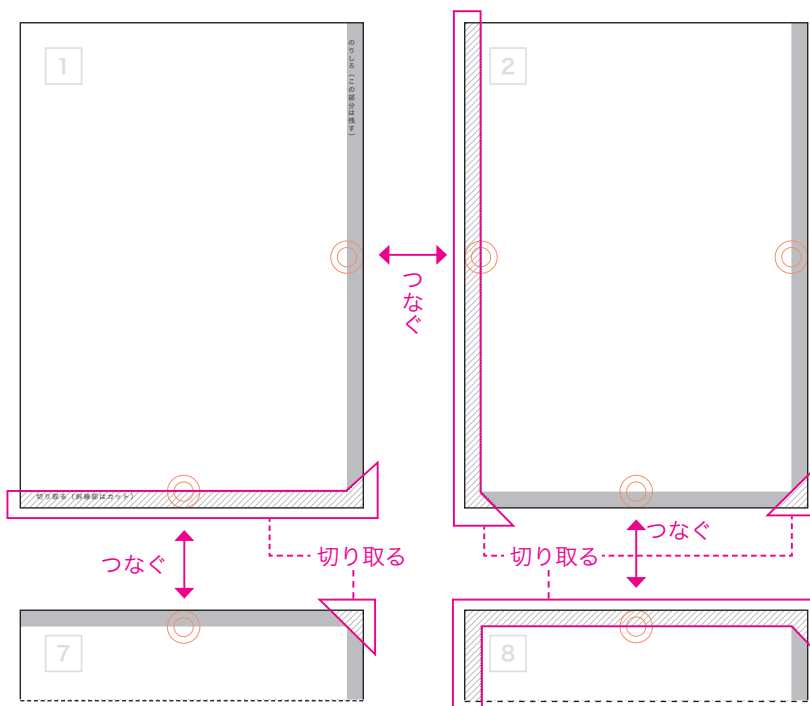

1

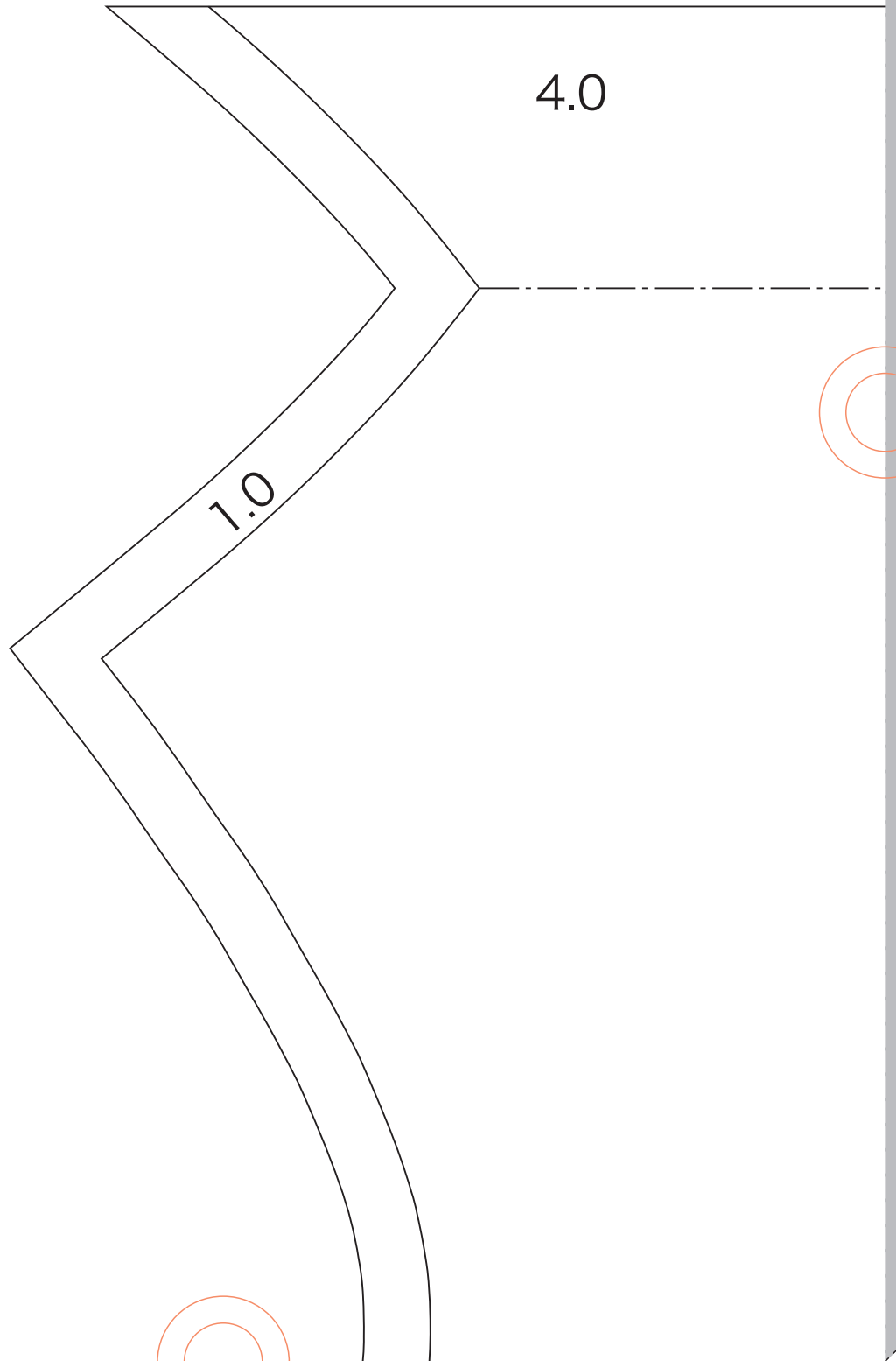

切り取る (斜線部はカット)

2

ロック 

折山線

前中心わ

f a b f a b-5

前身頃

size : 9

表×1枚

3

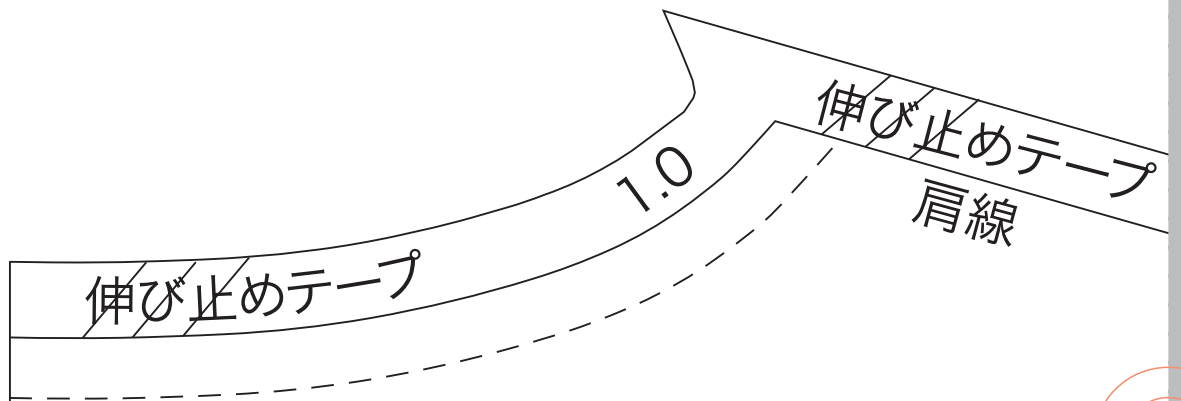

後ろ中心わ

f a b f a b - 5

後身頃

size : 9

表 × 1 枚

4

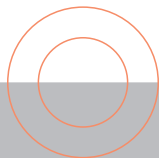
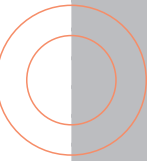
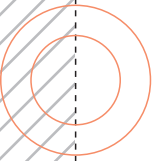
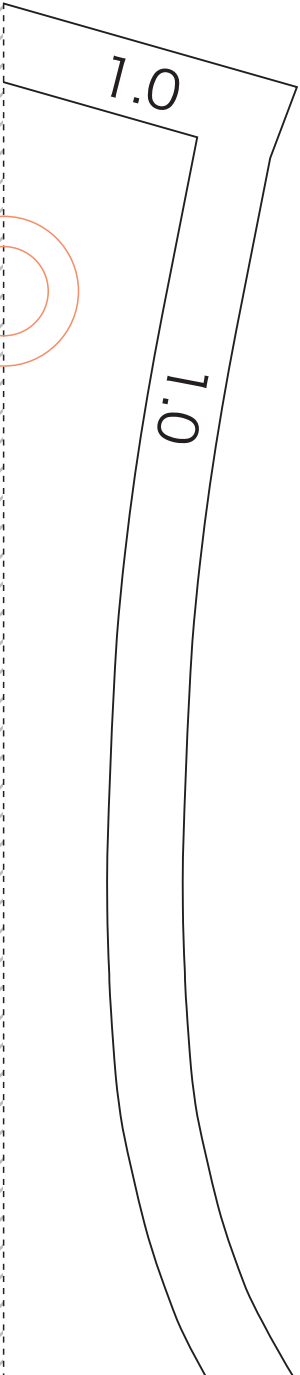

5

f a b f a b - 5
後衿ぐり布
size : 9
表 x 1 枚

B C

6

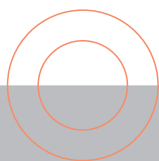
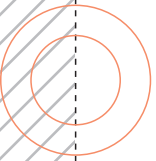

7

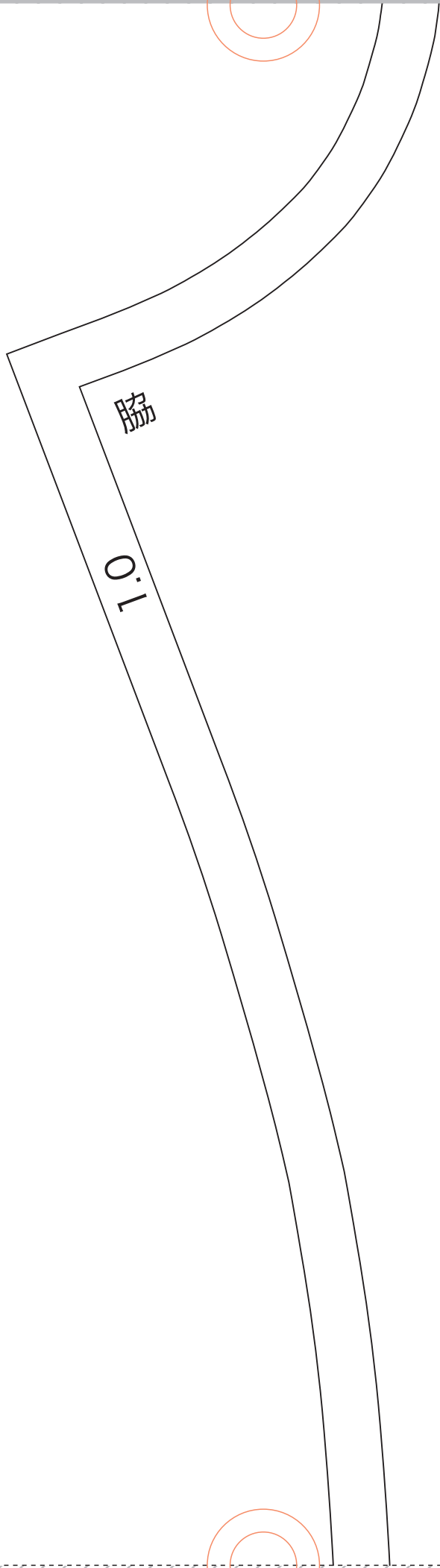

脇

1:0.1

8

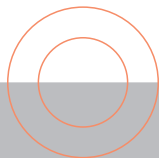
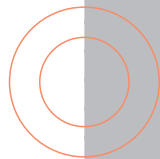
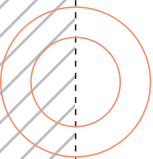
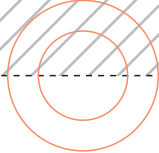

9

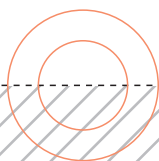
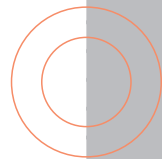
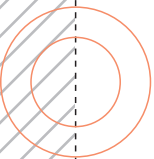
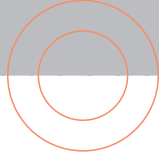

10

脇

1.0

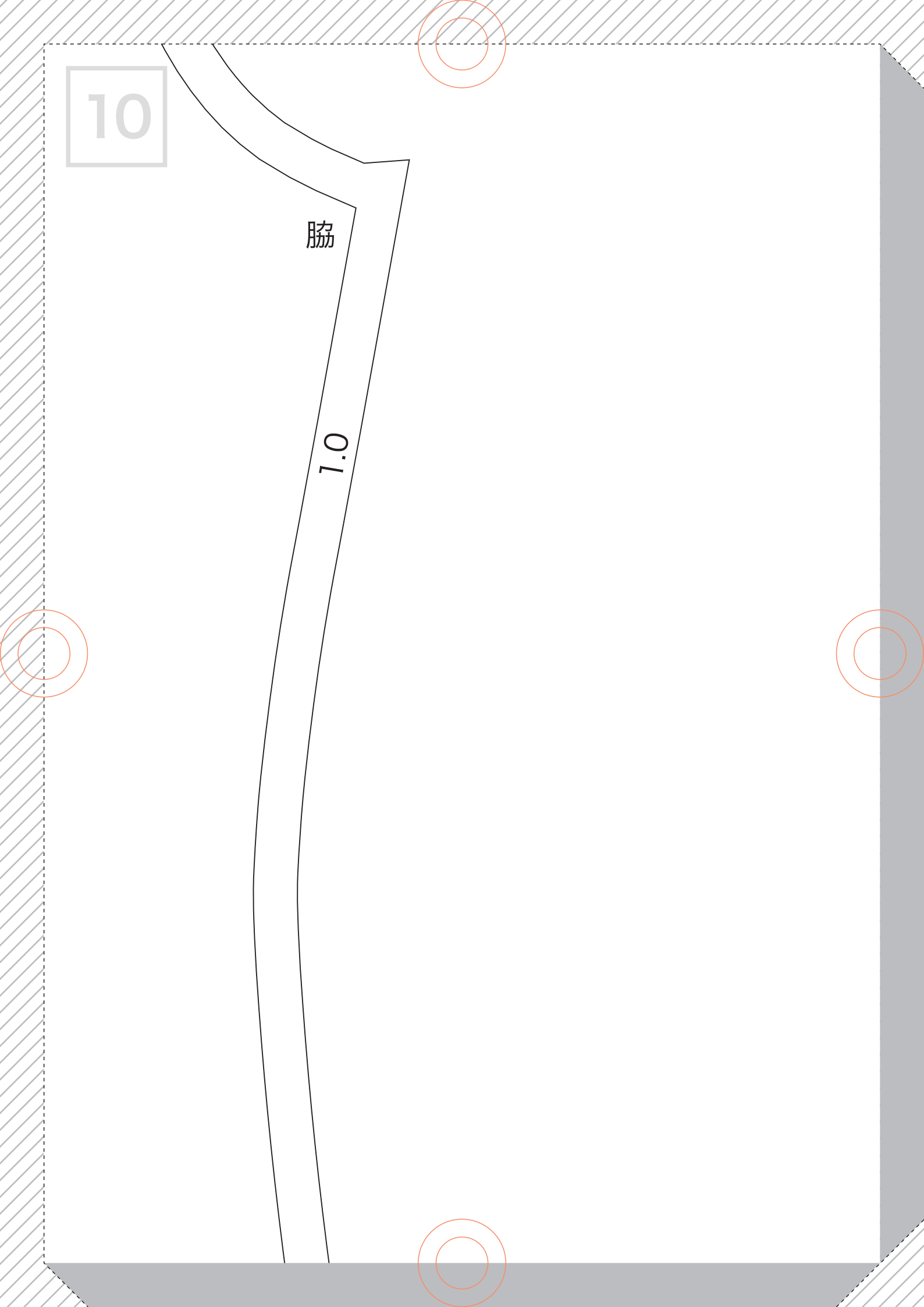

11

後ろ

1.0

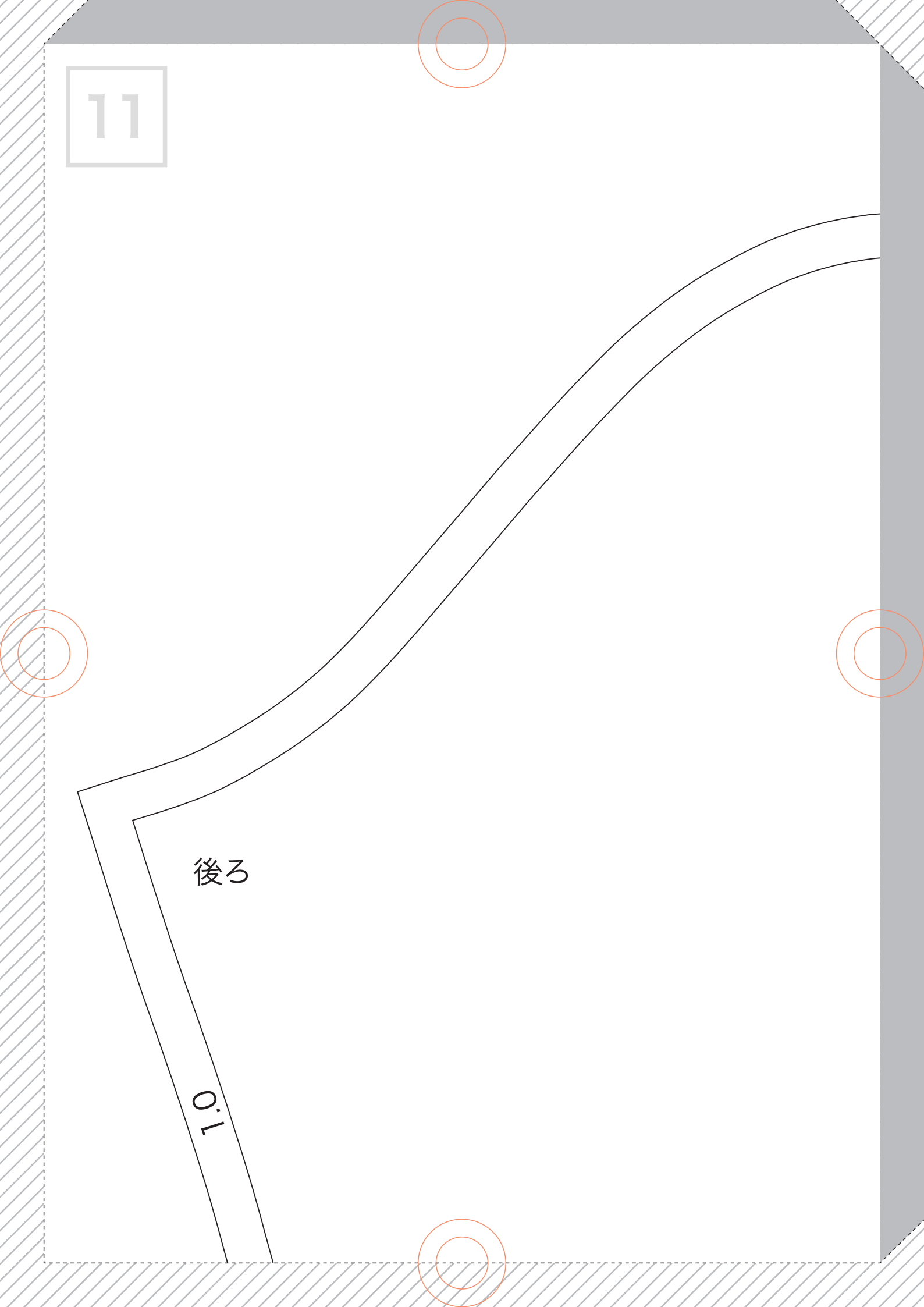

12

袖山

f a b f a b - 5
袖
size : 9
表 × 2 枚

1.0

前

1.0

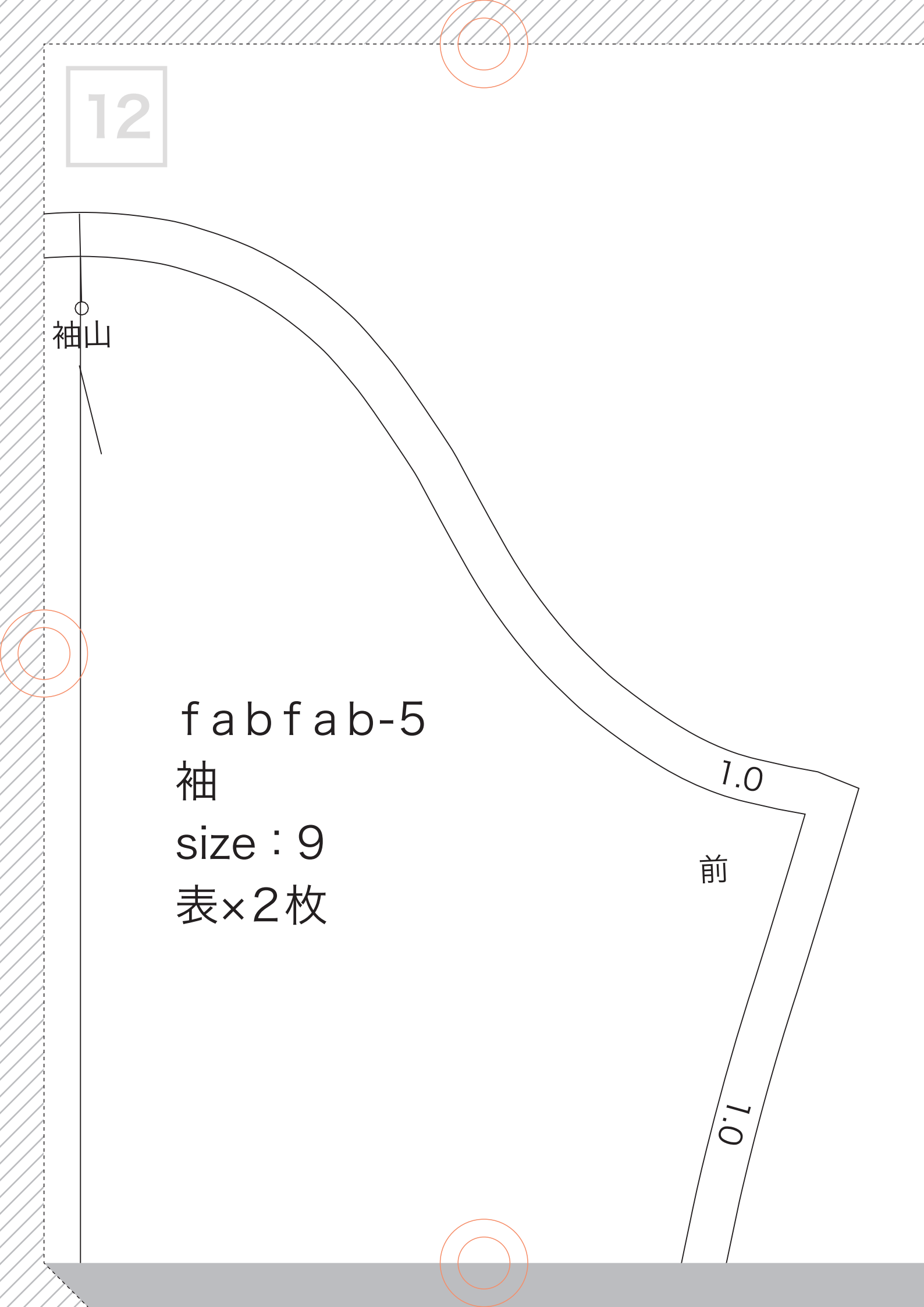

13

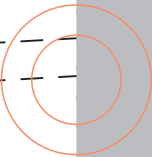
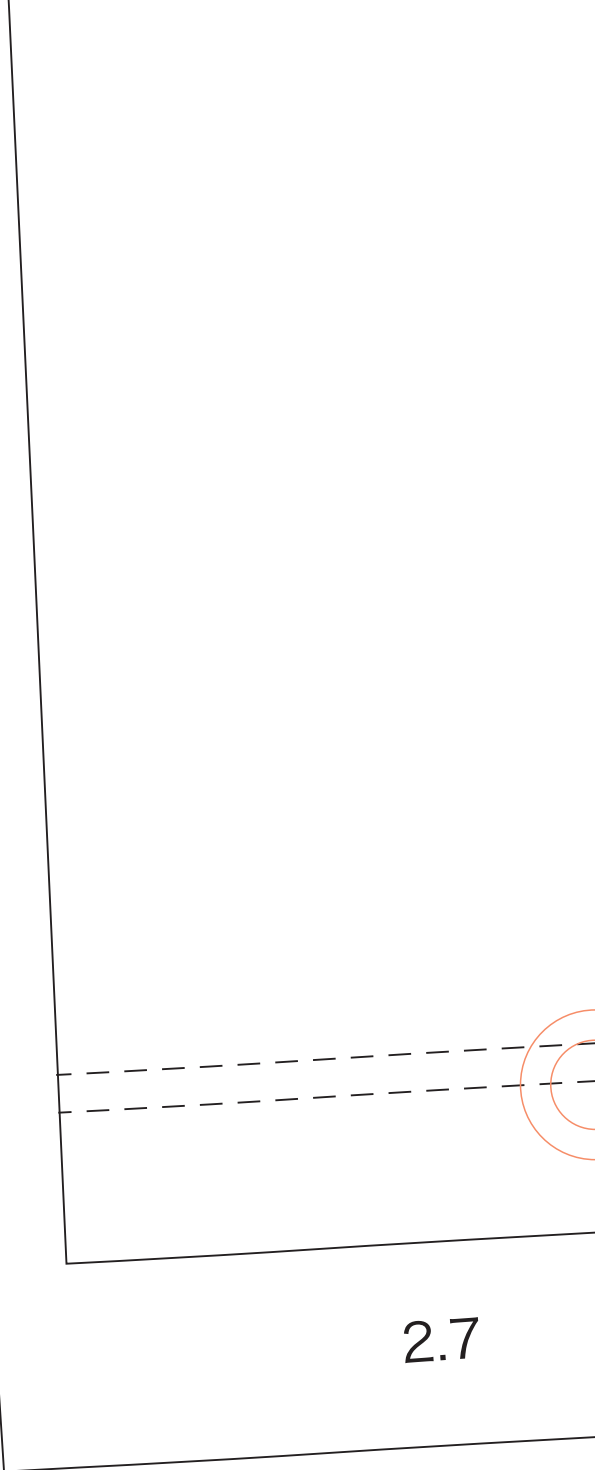

2.7

14

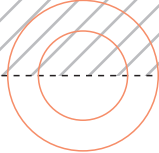

2cm+0.5cmWステッチ

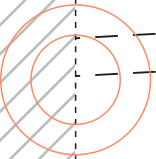

裾出来上がり線



15

2cm+0.5cmWステッチ

裾出来上がり線

2.7

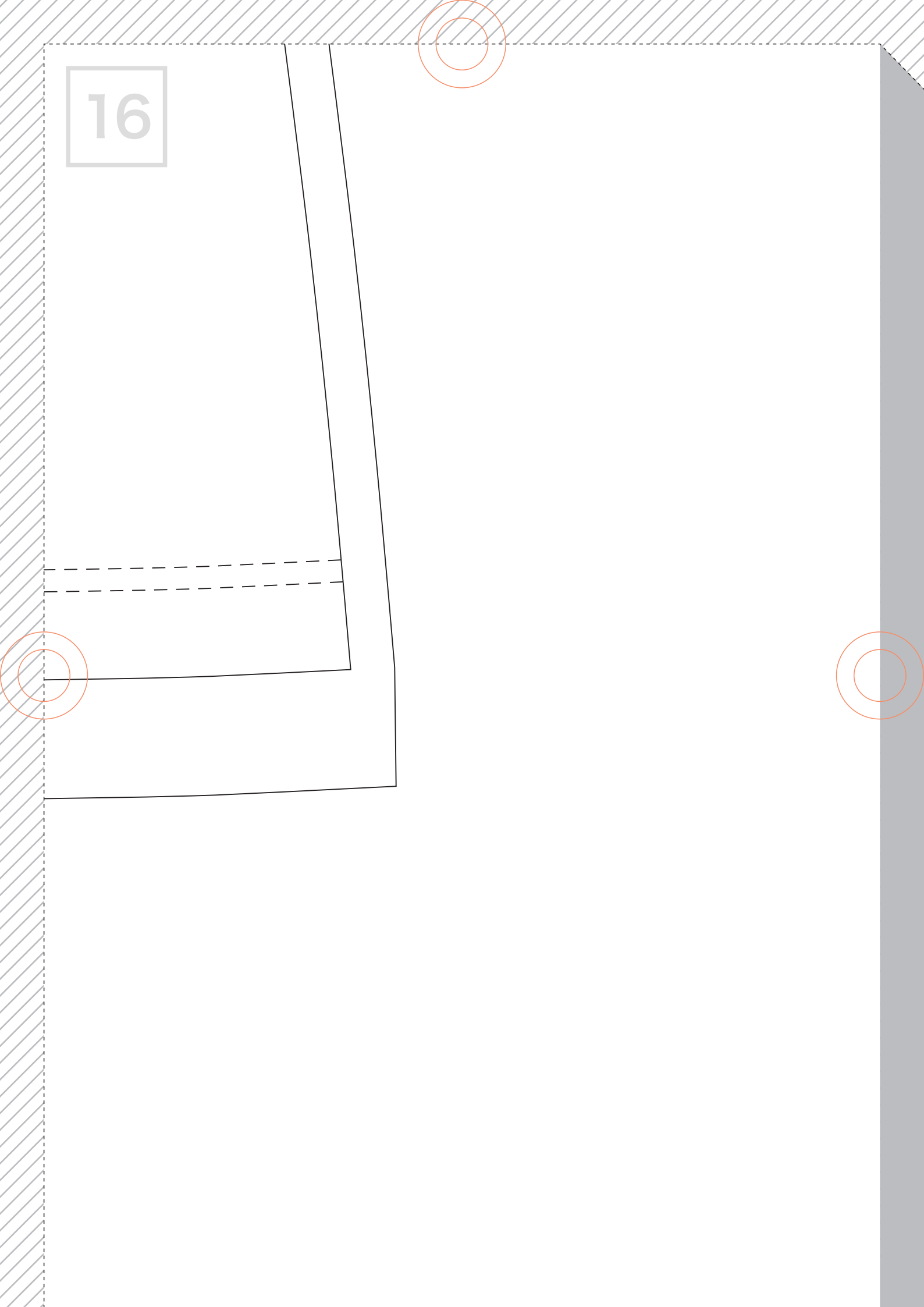

16

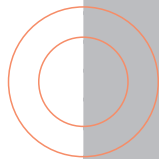
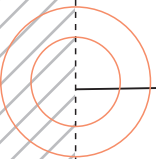
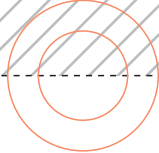

17

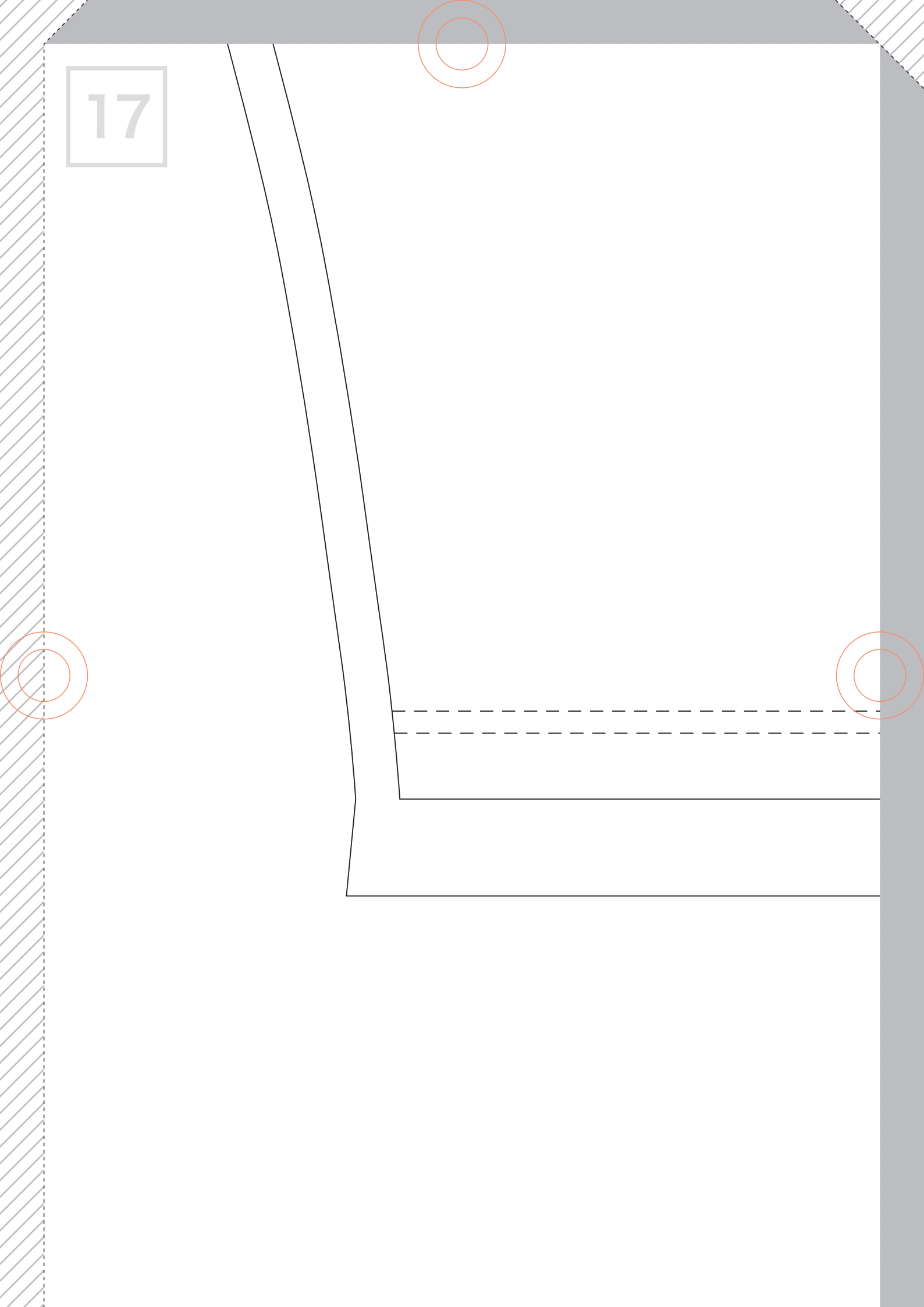
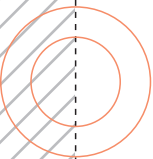
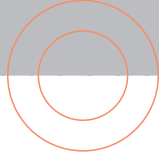

18

1.5cm+0.5cmWステッチ

袖口出来上がり線

2.2

