

introduction はじめに

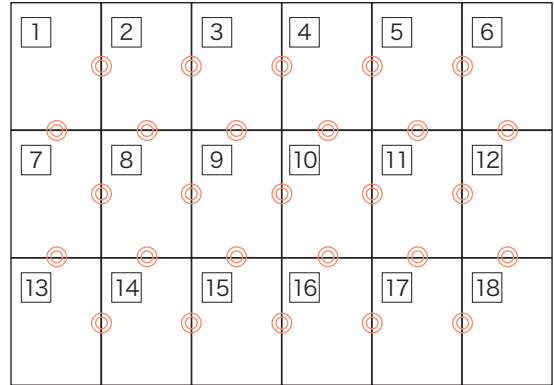

パターンは A4 サイズ 36 枚に分割されています。
印刷後、右図のようにつなぎ合わせてください。

! 印刷時の注意

印刷設定では、「ページの拡大や縮小」を選択せず
必ず、「実際のサイズ」(原寸) で印刷してください。



how to make パターンのつくりかた

STEP1 斜線部分  は切り取り、灰色部分  は残してのりしろにします。
(斜線と灰色を間違えないように注意)

STEP2 各用紙の番号を確認し、 の位置を合わせて、のりつけします。
(水のりは用紙が波打ちます。スティック糊などをお使いください)

STEP3 それぞれのパーツをハサミで切り出します。

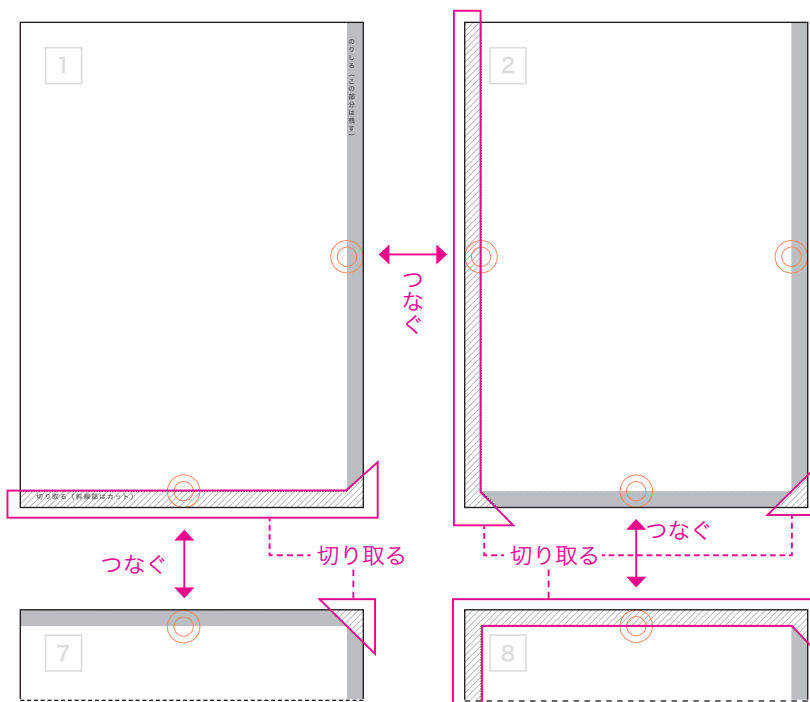
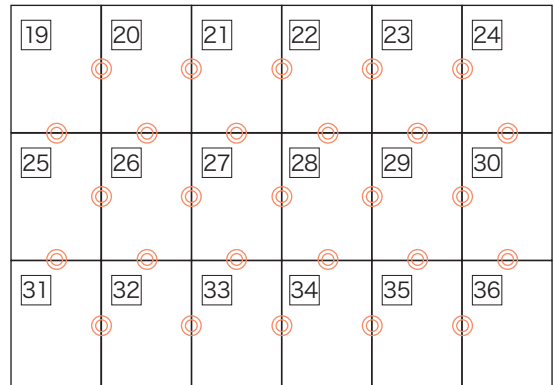

1

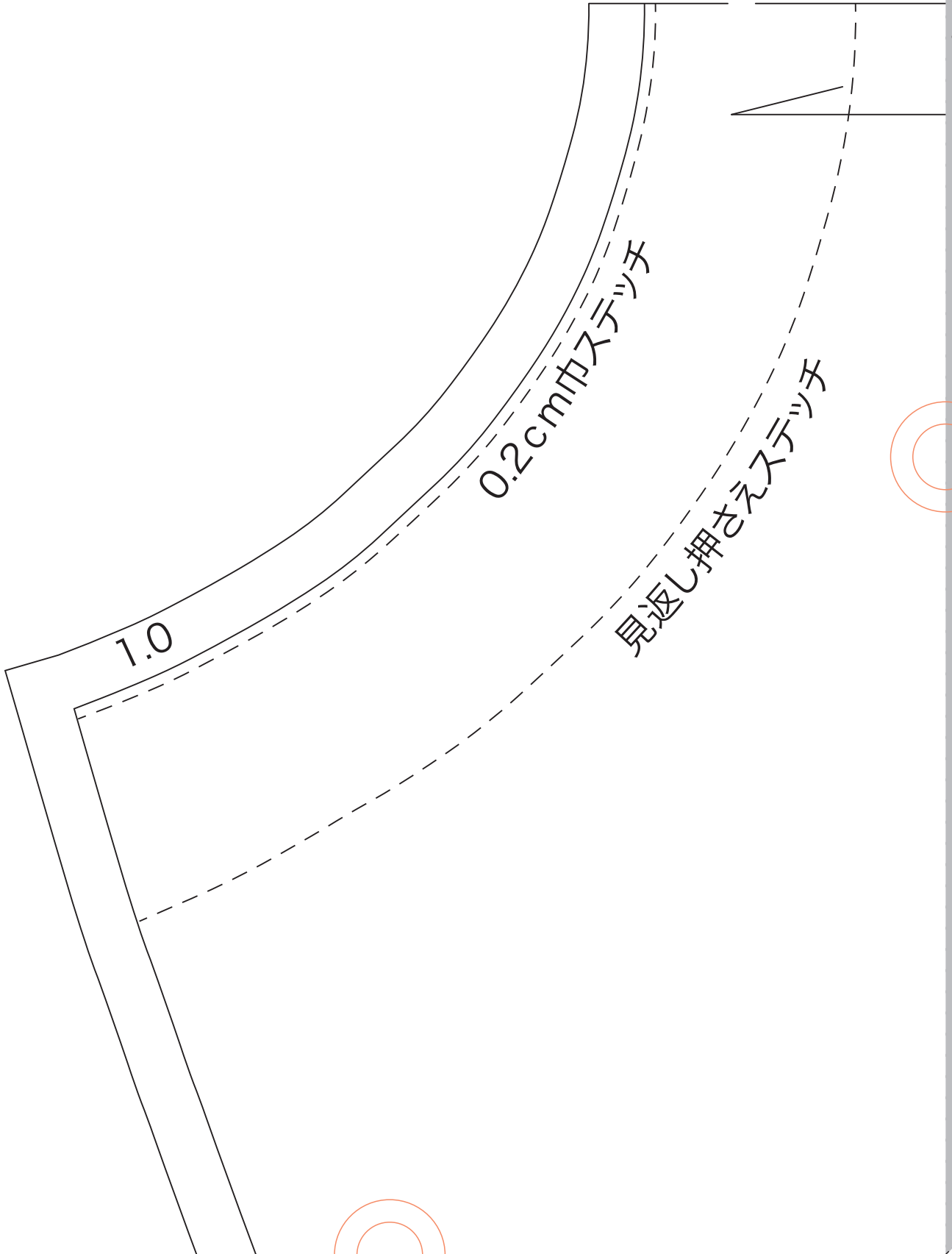

切り取る (斜線部はカット)

2

前中心カ

fabfab-6

前身頃

size: 11

表×1枚

3

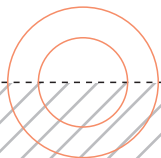
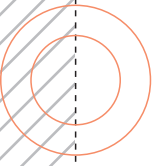

4

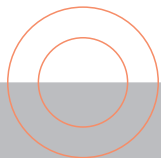
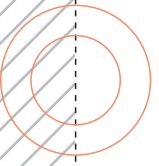

5

2.5cm幅三つ折りステッチ

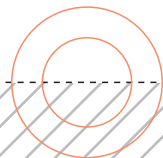
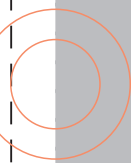
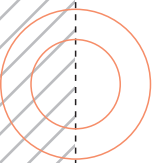

6

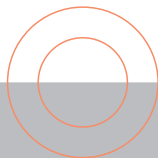
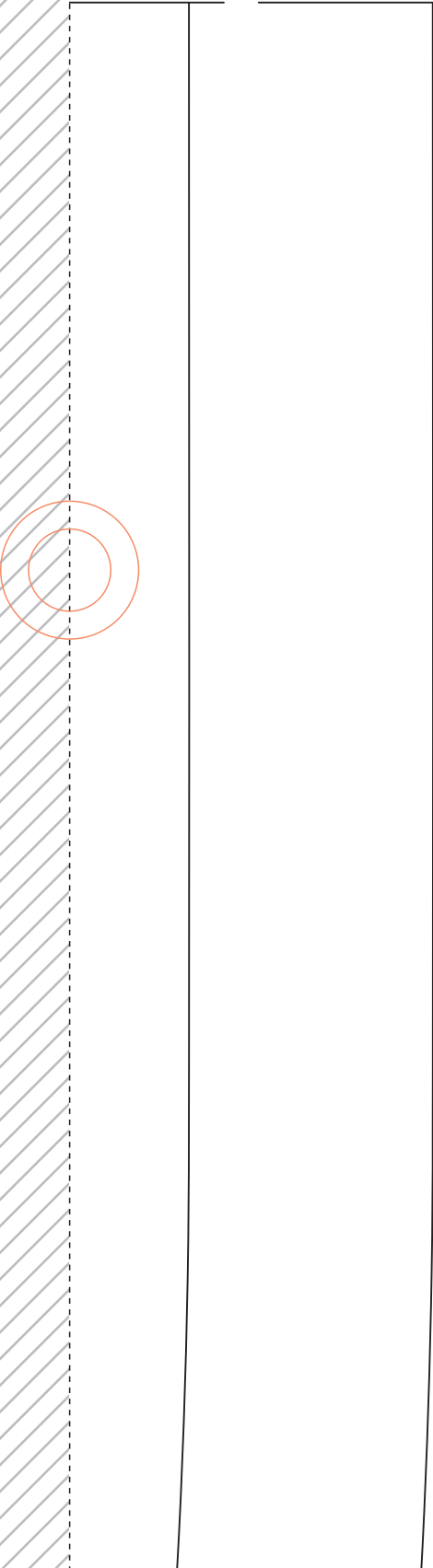

7

1:0

1:0

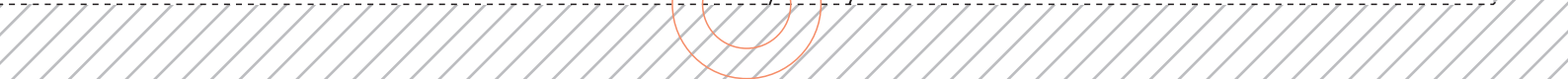
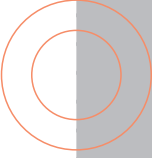
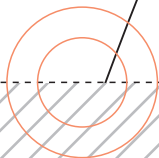
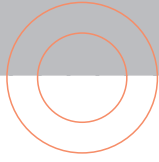

8

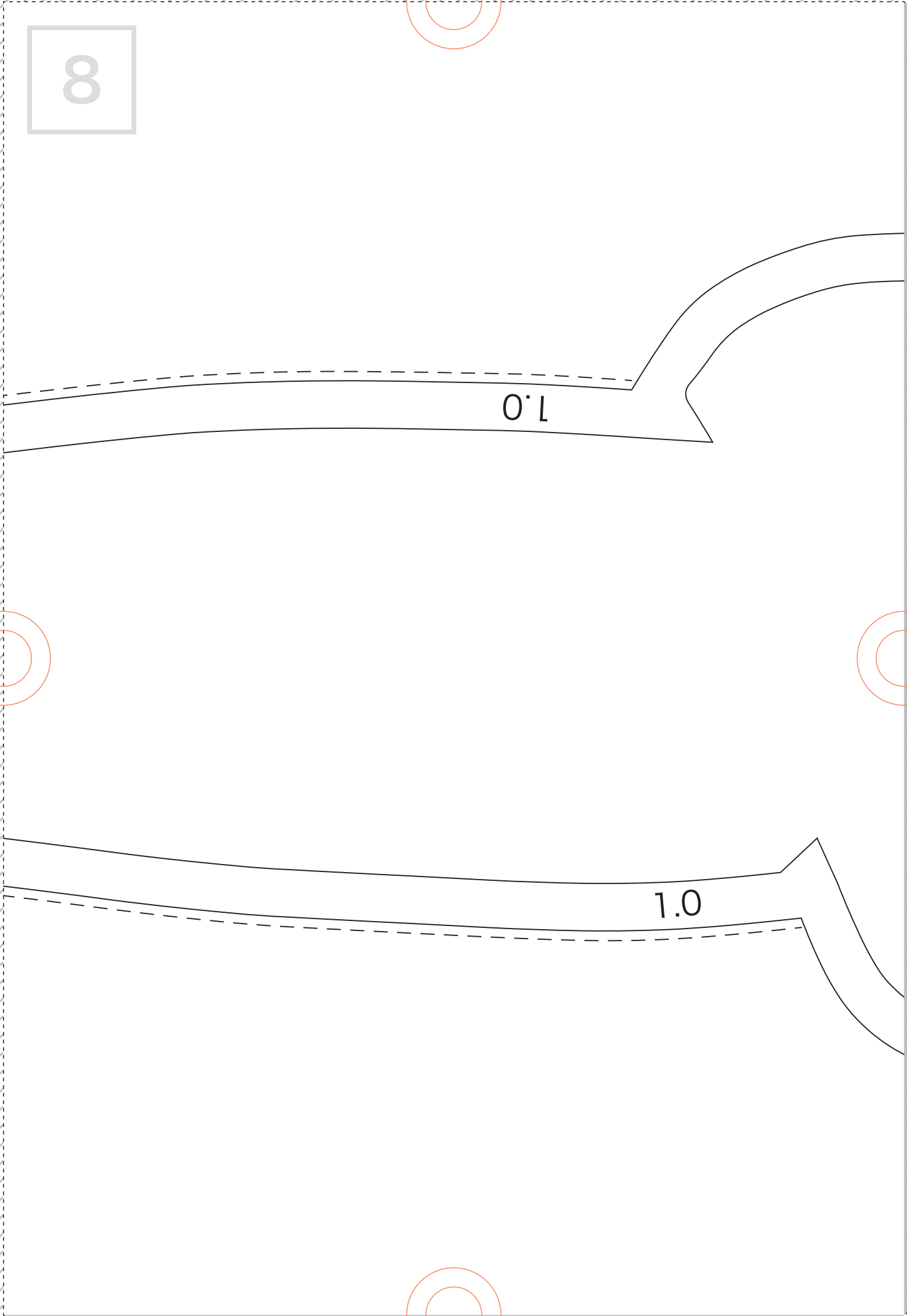
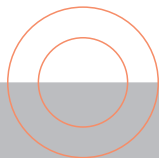
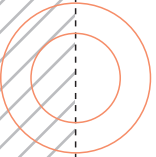
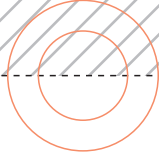

0.1

1.0

9

1.0

1.0

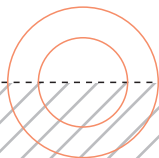
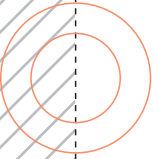
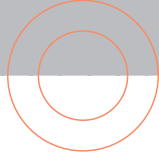

10

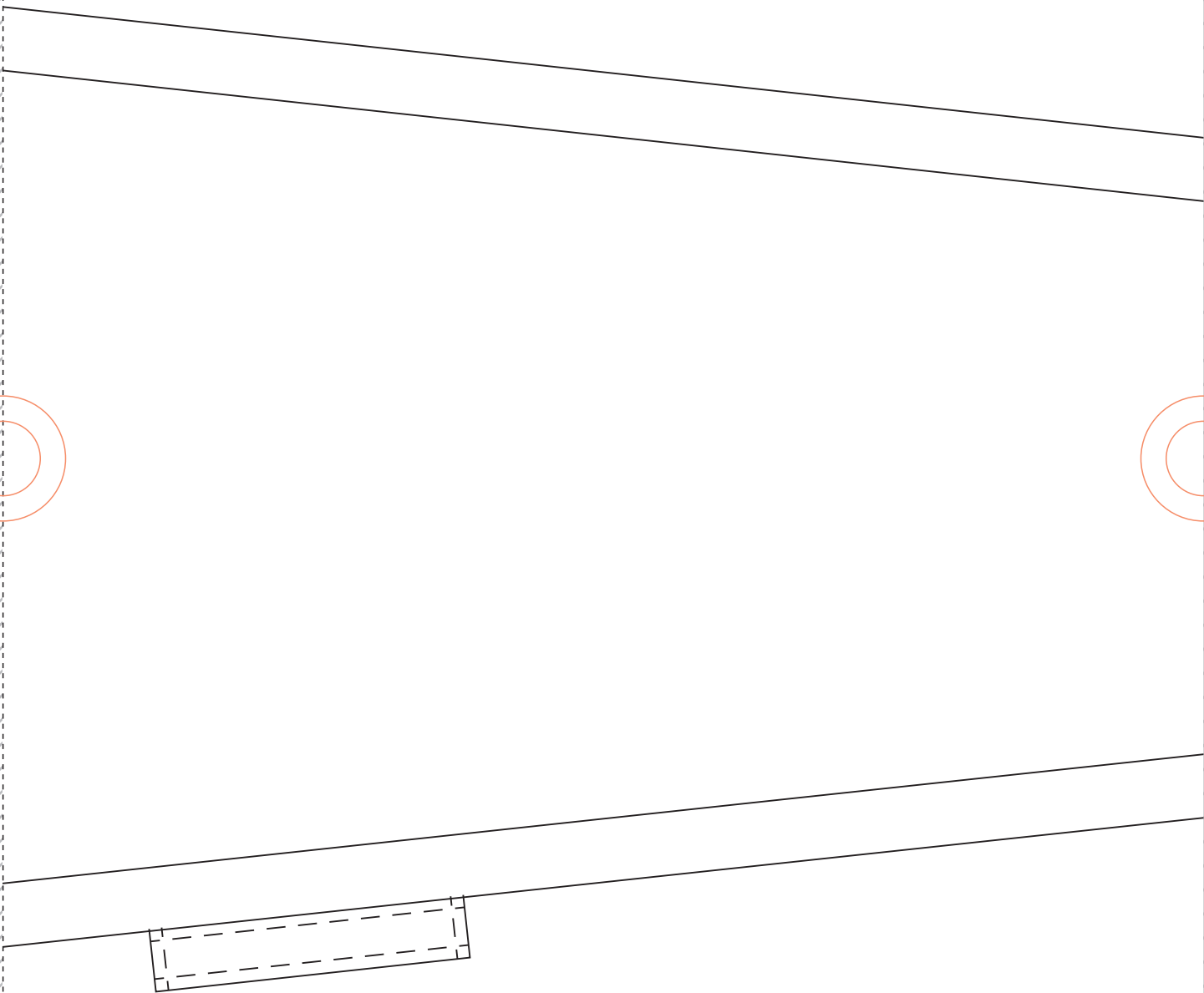
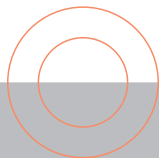
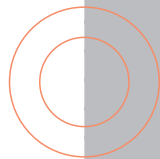
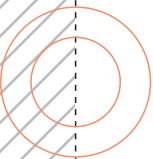
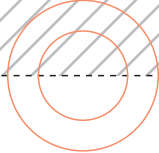

11

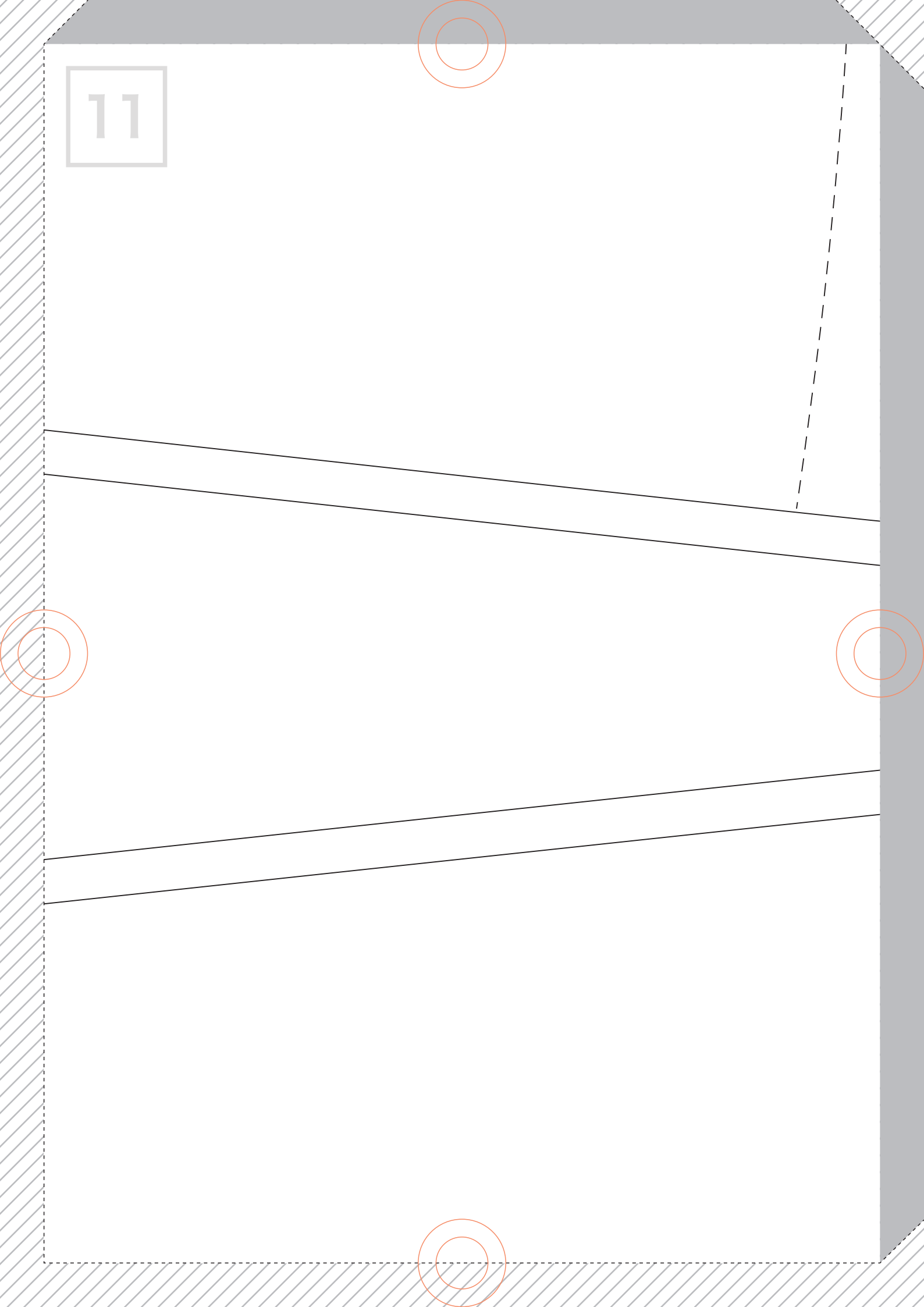
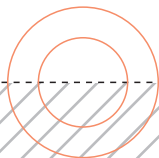
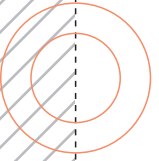
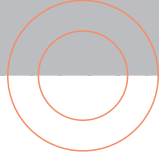

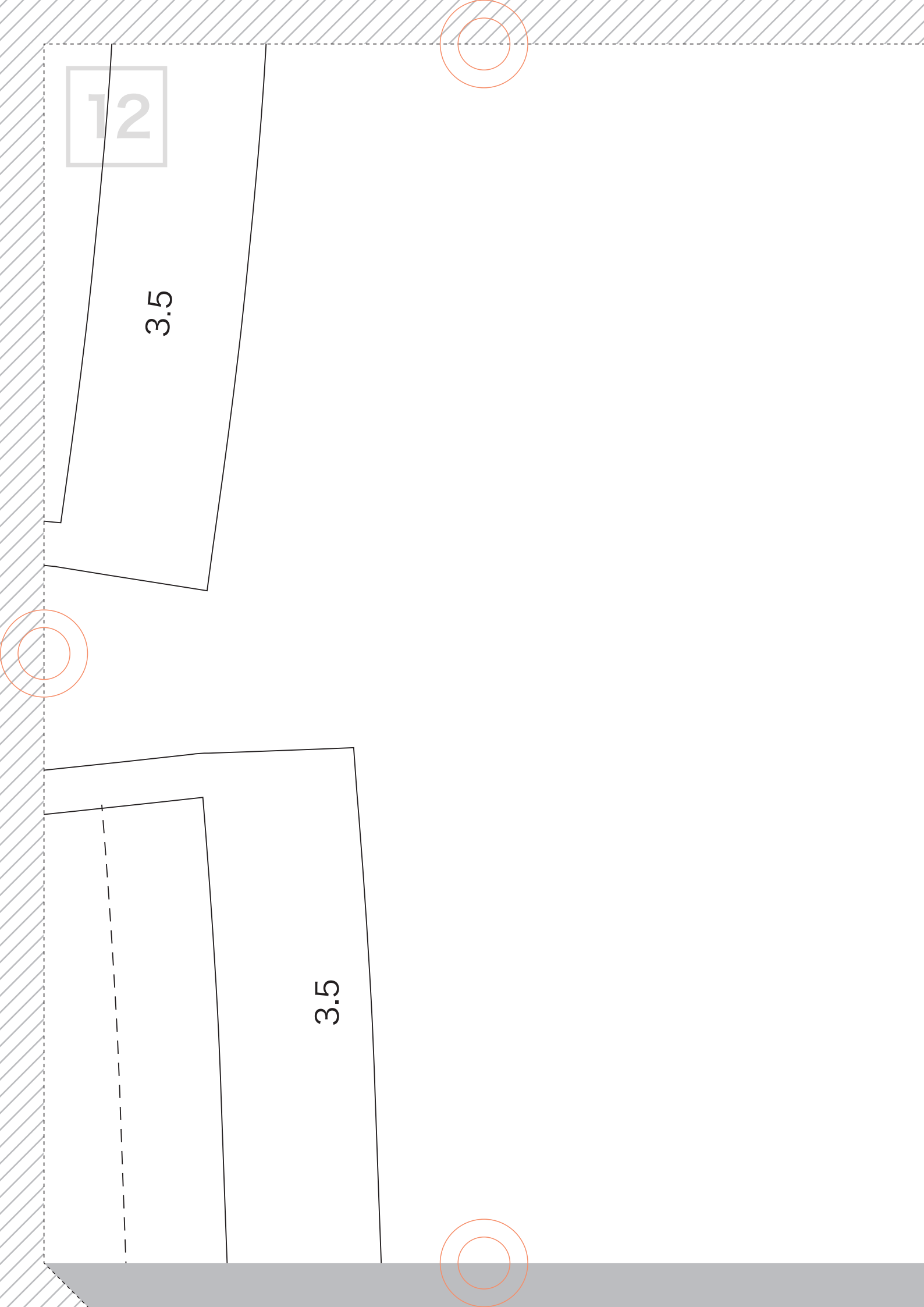

12

3.5

3.5

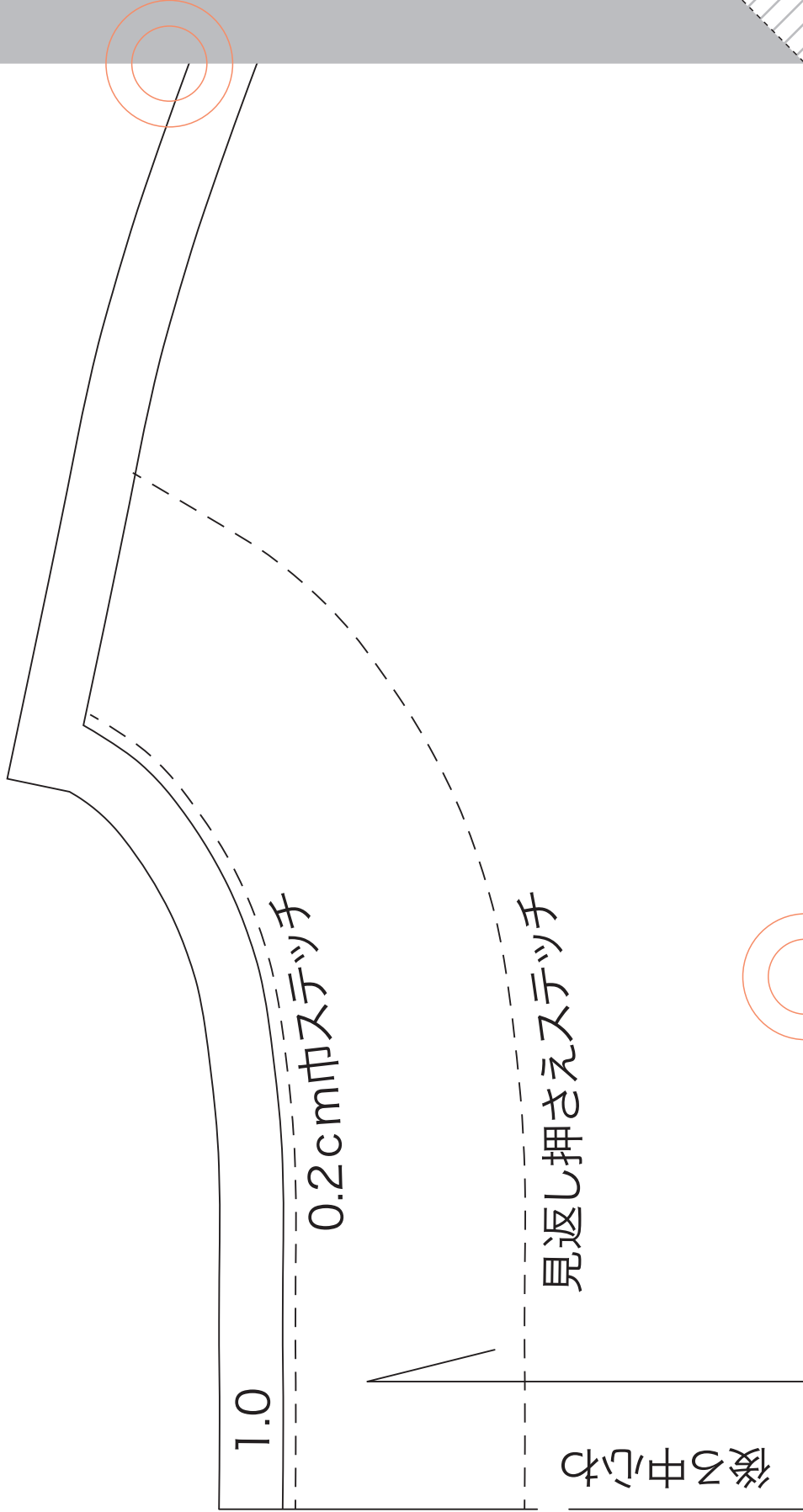

14

f a b f a b - 6

後身頃

size : 11

表×1枚

15

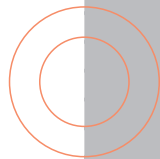
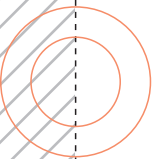
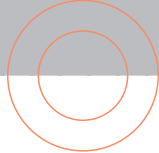

16

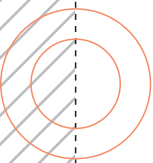
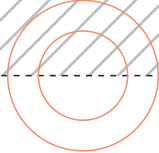

17

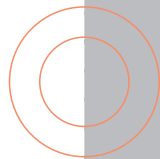
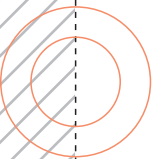
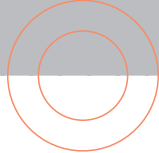

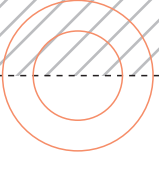

18

2.5cm幅三つ折りステッチ

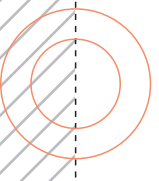

19

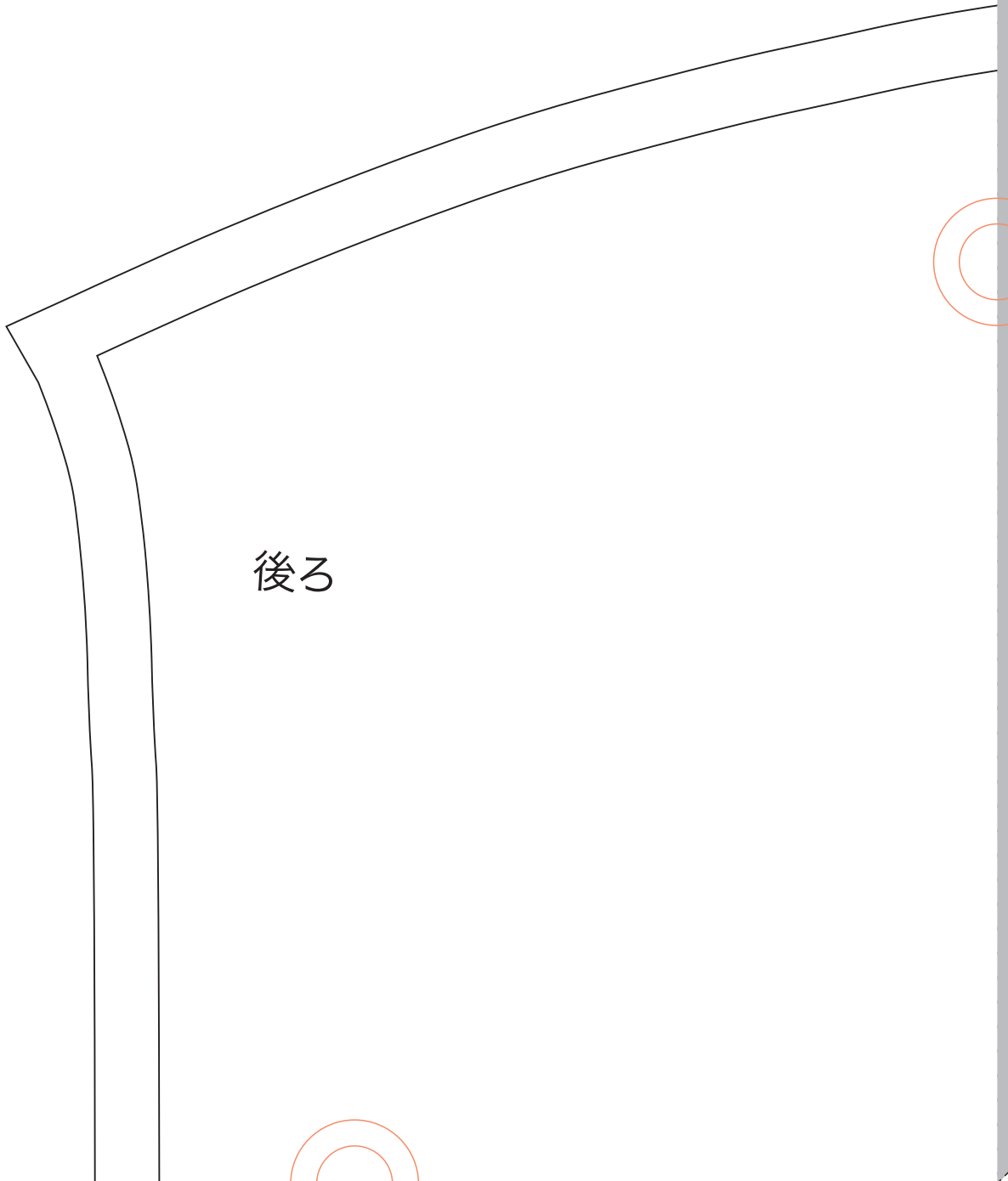

切り取る (斜線部はカット)

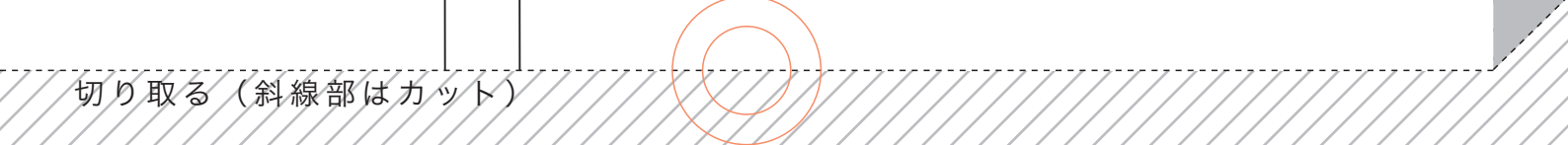

20

袖山

地の目線

f a b f a b - 6

袖

size : 11

表×2枚

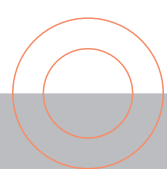
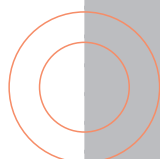
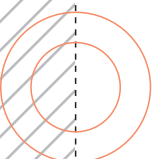

21

1.0

前

1.0

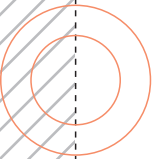

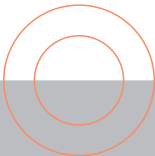
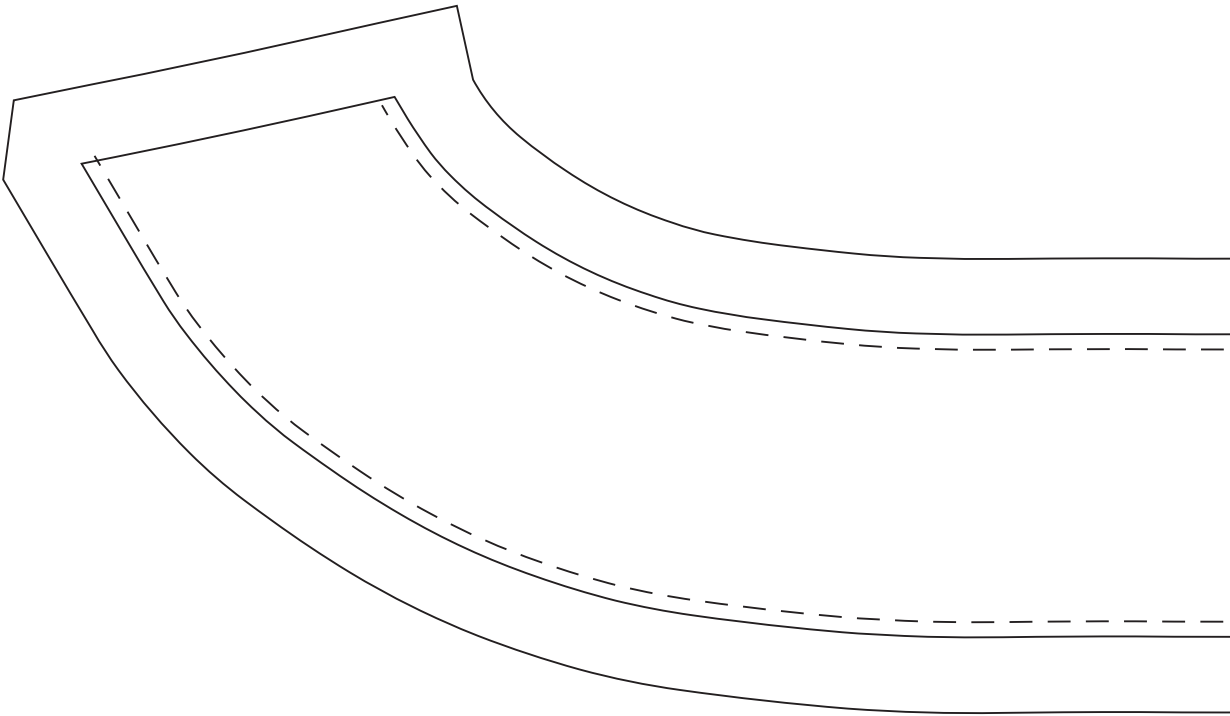
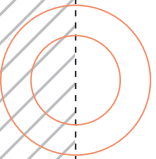

23

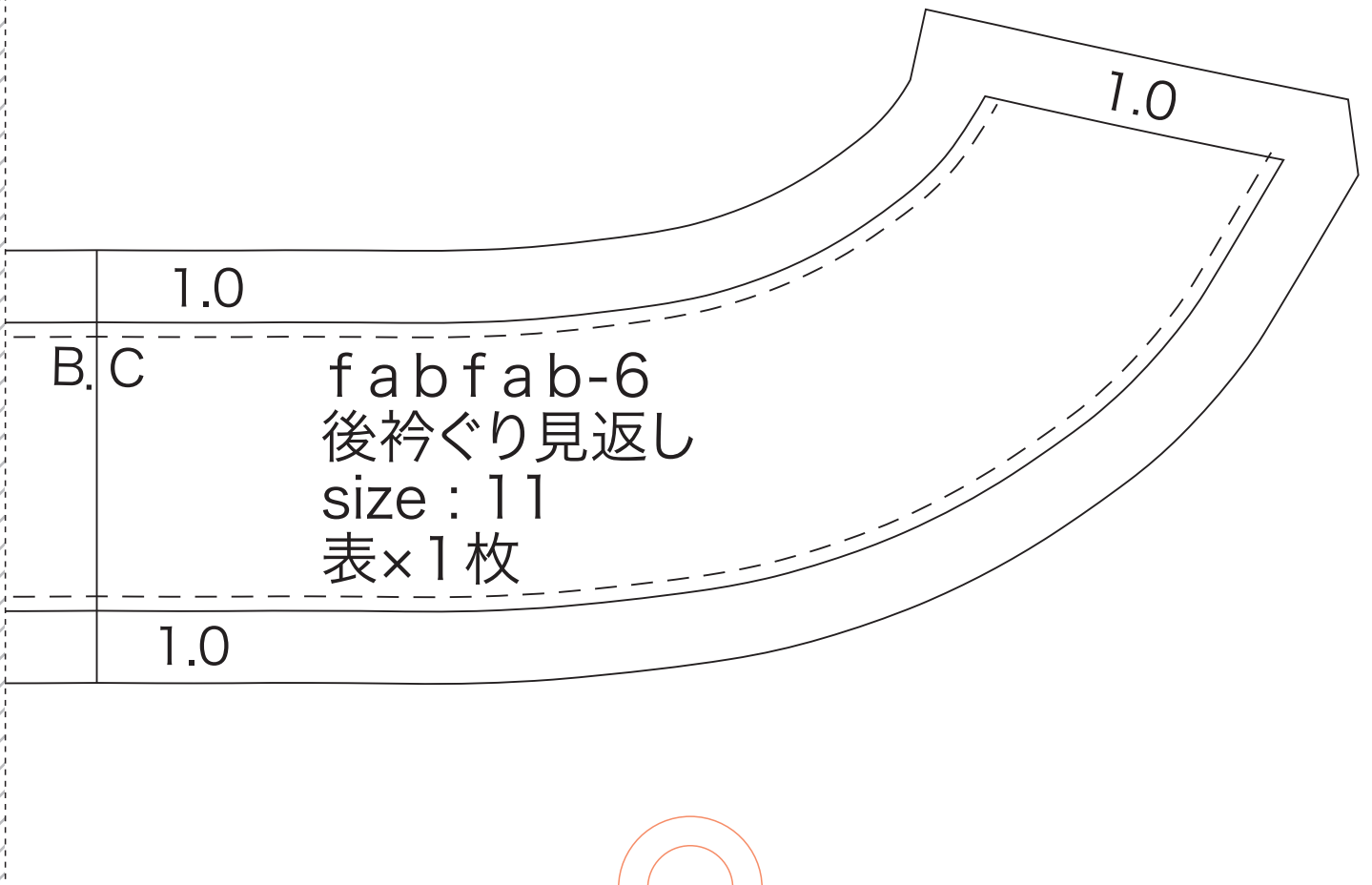

24

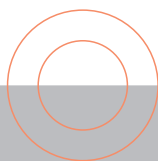
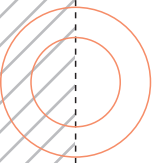

25

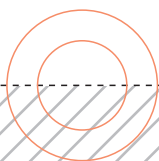
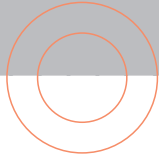
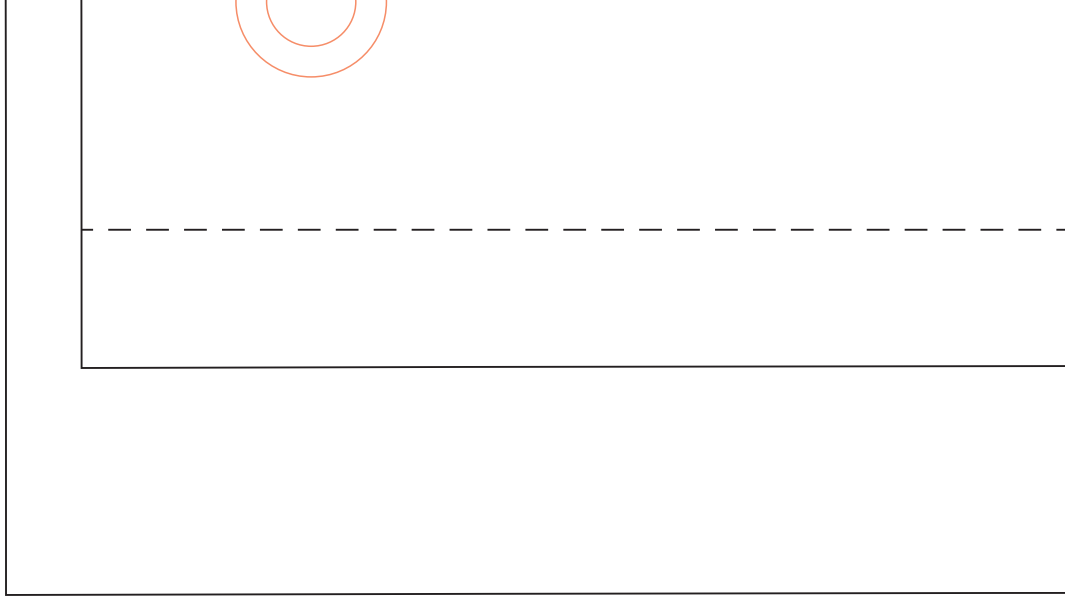

26

2cm幅三つ折りステッチ

fabfab-6	
ベルト通し	
size : 11	
1.0	表×2枚

27

3.0

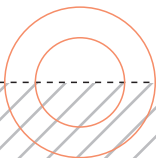
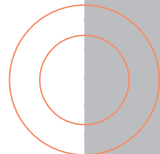
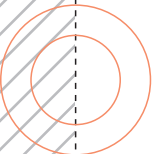
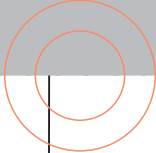

28

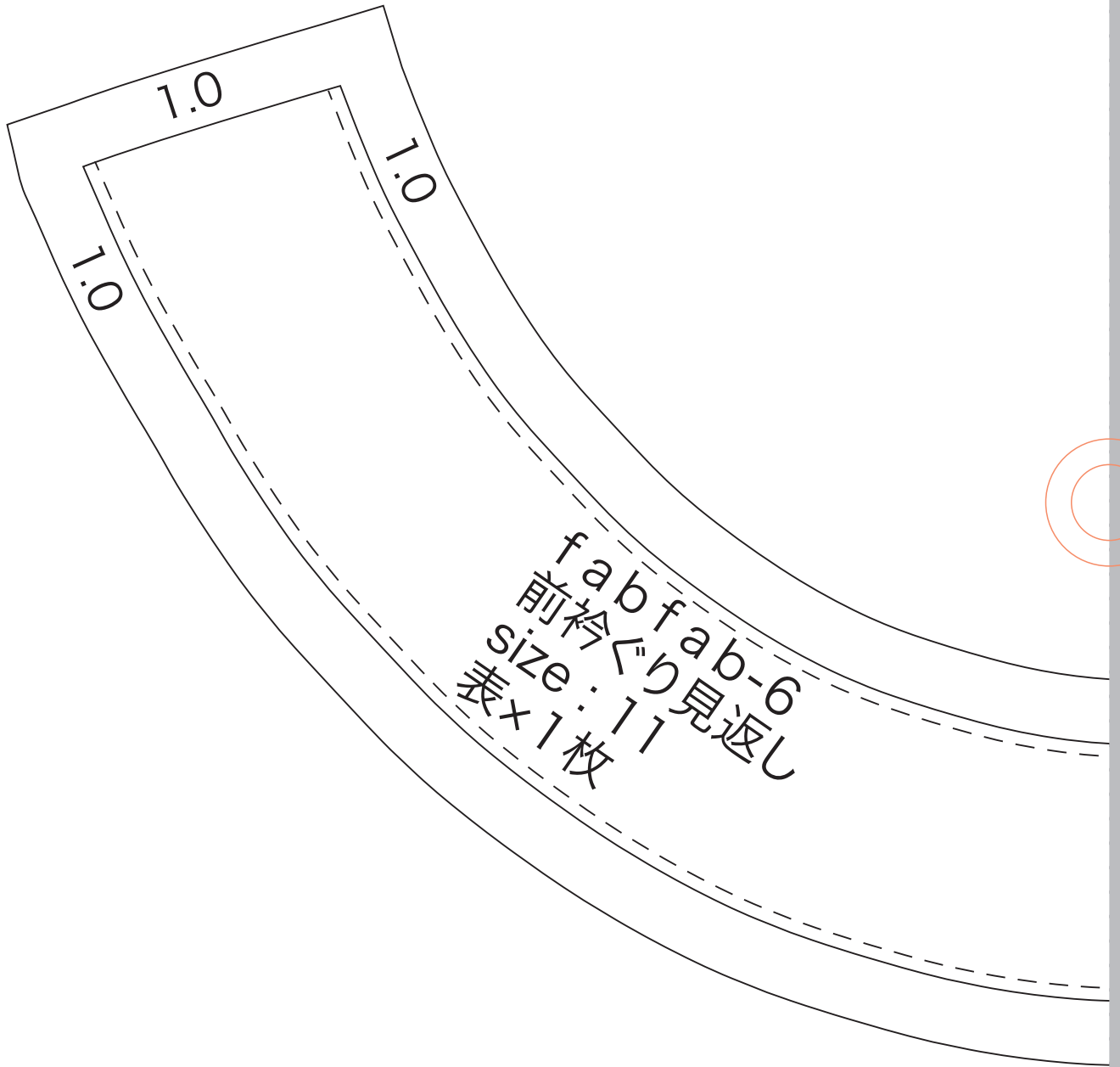

29

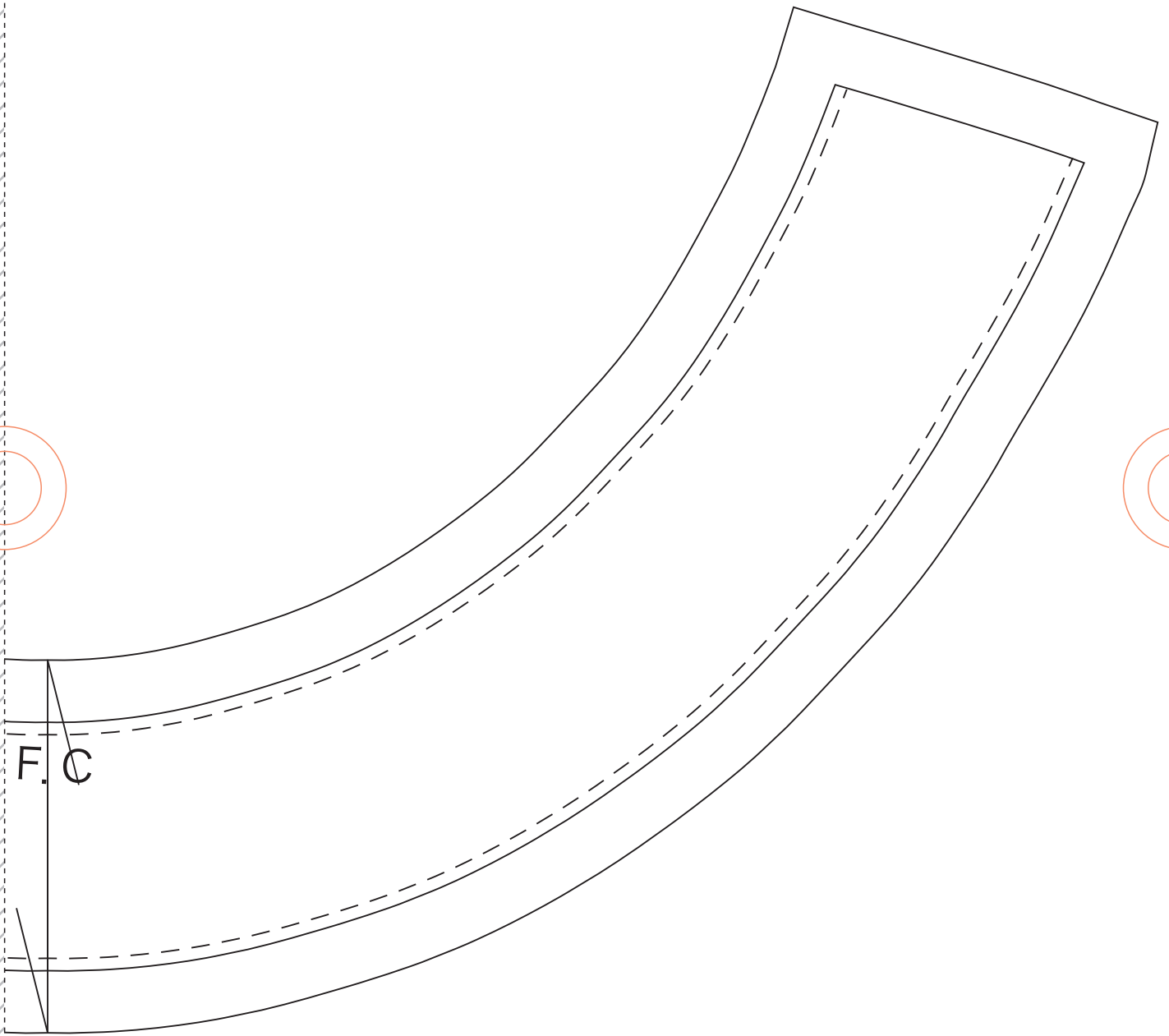

30

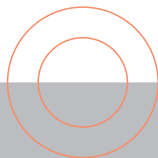
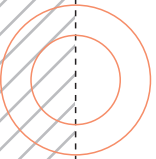
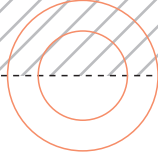

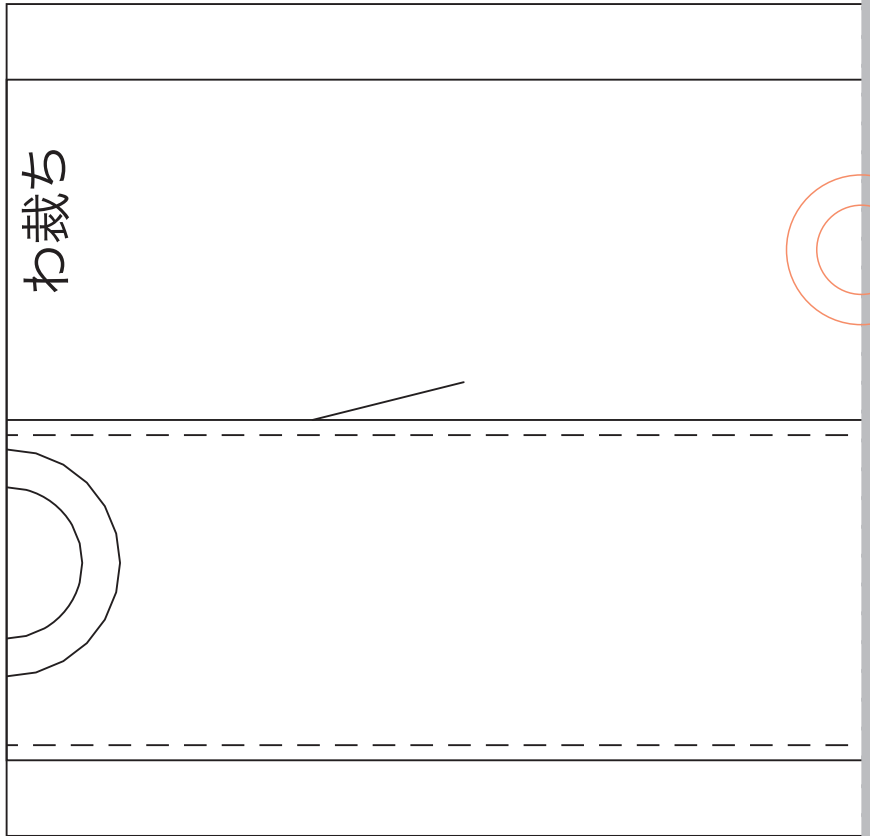
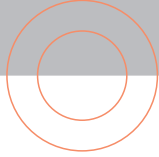

32

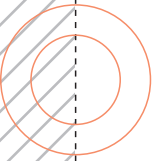
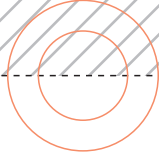

33

fabfab-6
ベルト
size : 11
表×1枚

34

折山線

35

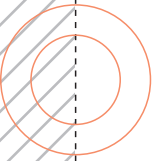
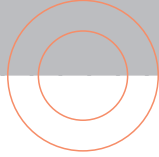

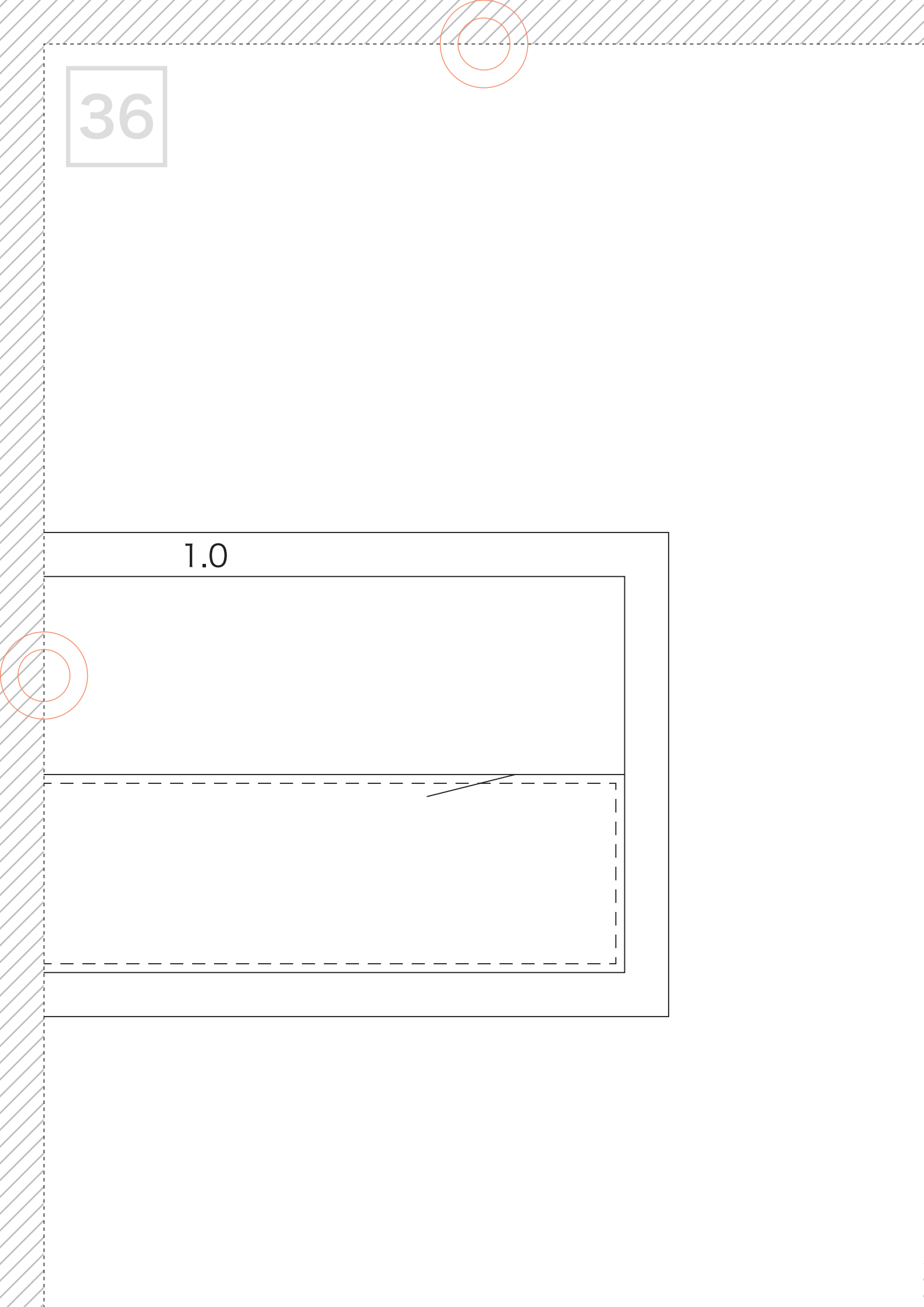

36

1.0