

## introduction はじめに

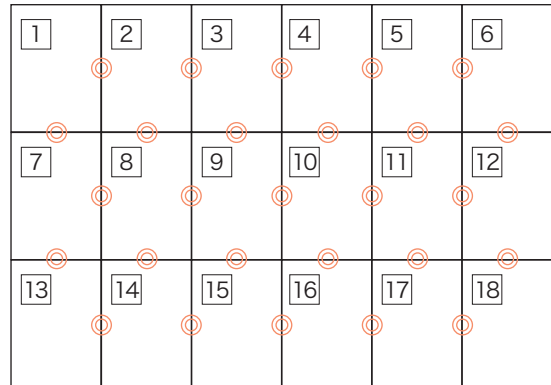

パターンは A4 サイズ 36 枚に分割されています。  
印刷後、右図のようにつなぎ合わせてください。

### ! 印刷時の注意

印刷設定では、「ページの拡大や縮小」を選択せず  
必ず、「実際のサイズ」(原寸) で印刷してください。



## how to make パターンのつくりかた

**STEP1** 斜線部分  は切り取り、灰色部分  は残してのりしろにします。  
(斜線と灰色を間違えないように注意)

**STEP2** 各用紙の番号を確認し、 の位置を合わせて、のりつけします。  
(水のりは用紙が波打ちます。スティック糊などをお使いください)

**STEP3** それぞれのパーツをハサミで切り出します。

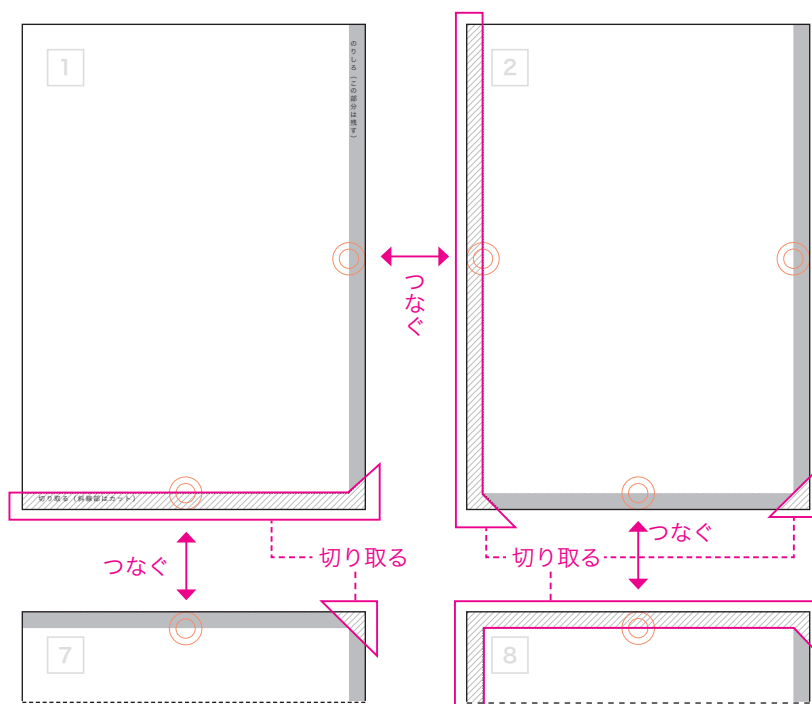
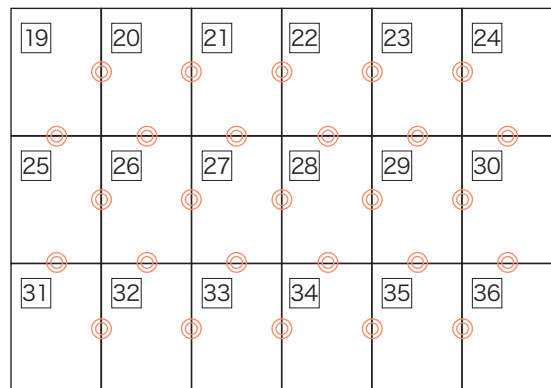

1

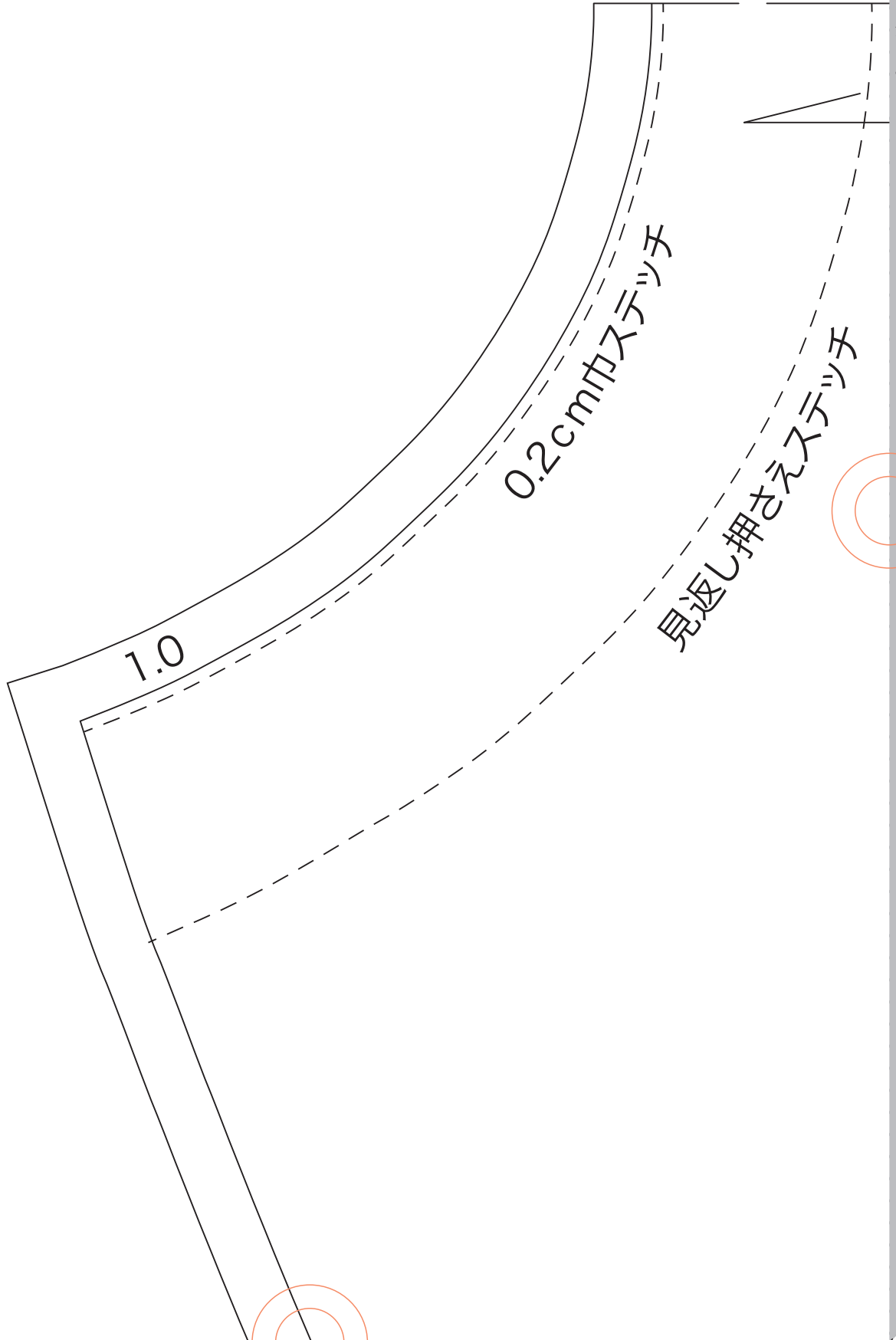

切り取る (斜線部はカット)

2

前中心わ

f a b f a b - 6

前身頃

size : 7

表×1枚

3

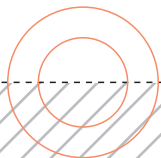
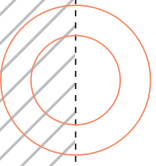

4

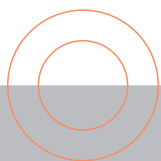
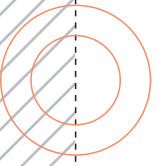

5

2.5cm幅三つ折りステッチ

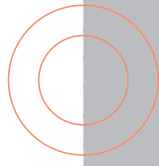
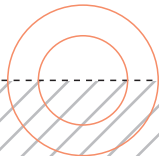
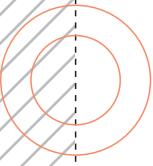

6

3.5

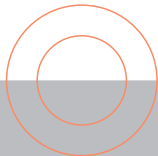
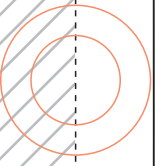

7

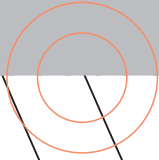

1:0



1:0

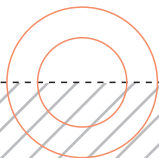



8

0.1

1.0

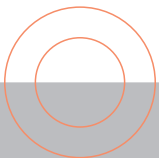
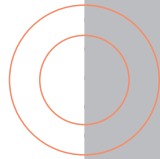
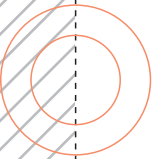
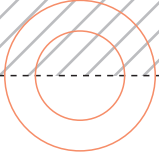

9

0.1

1.0

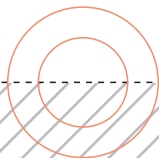
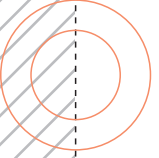
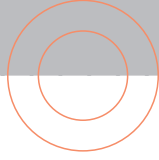

10

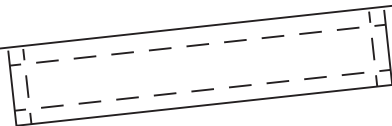
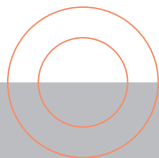
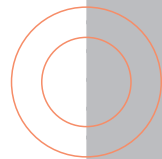
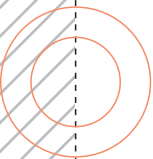
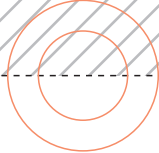

11

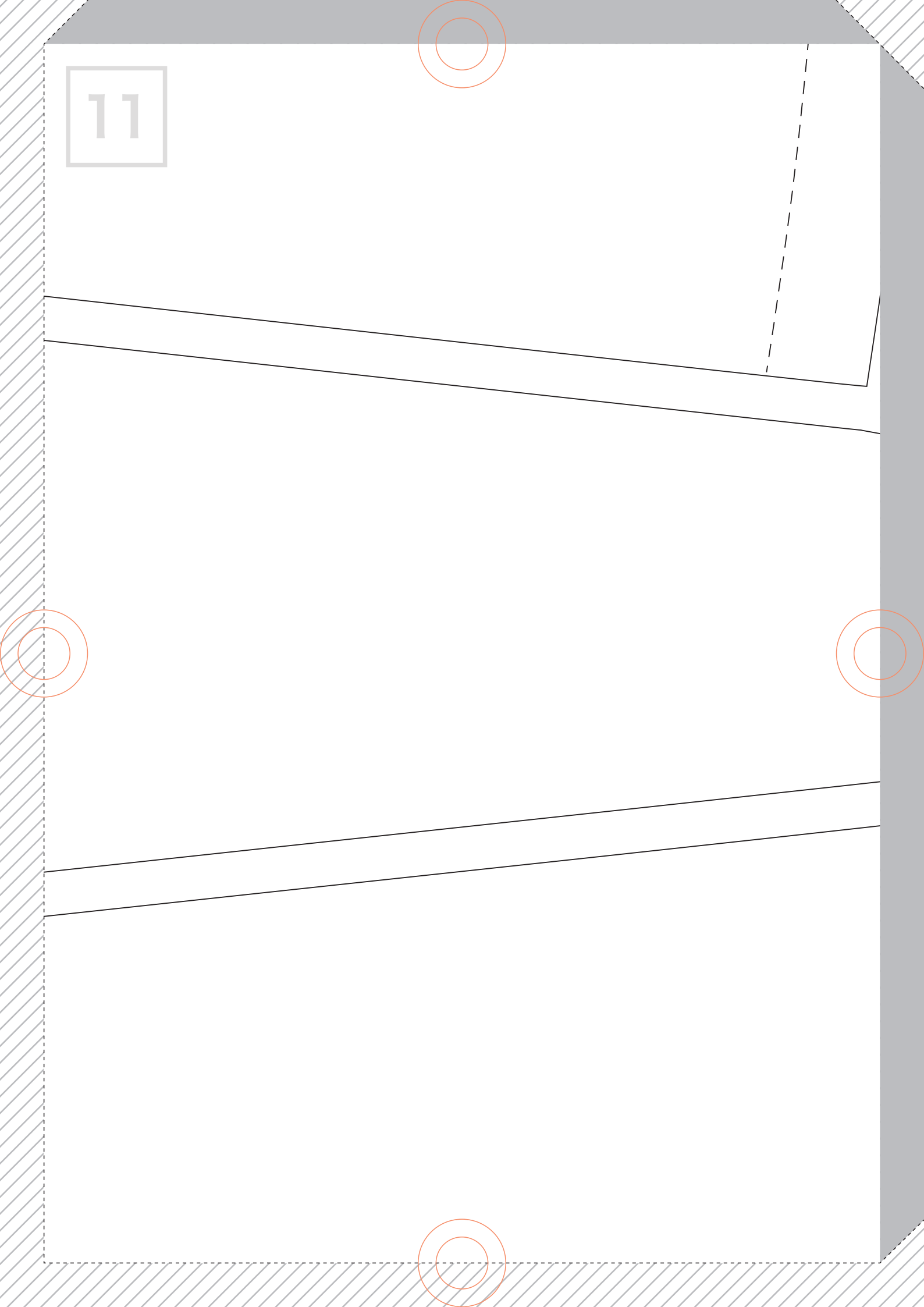
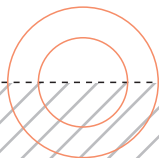
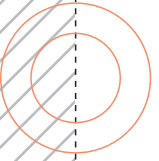
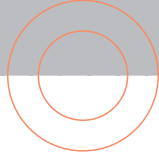

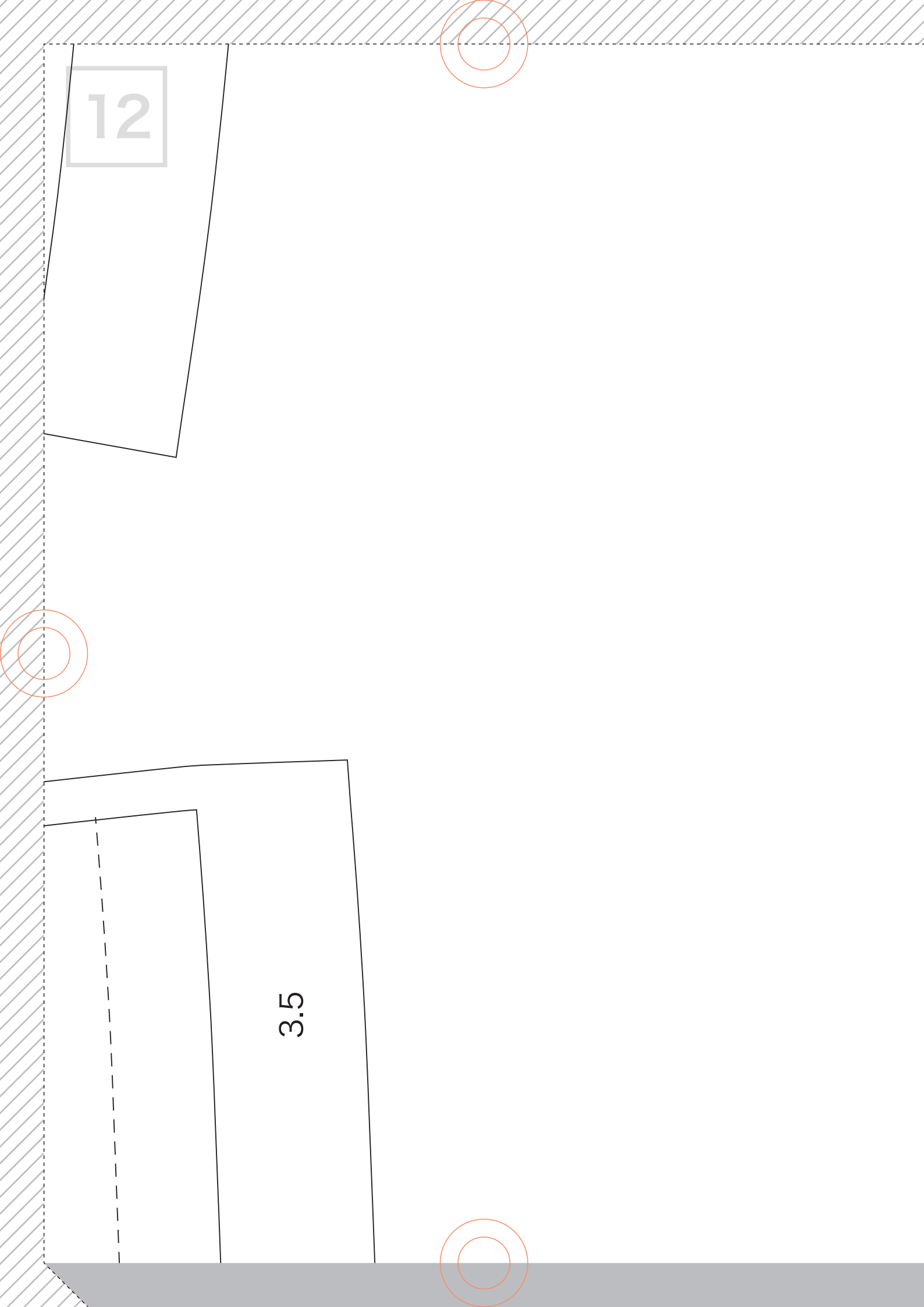

12

3.5

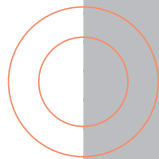
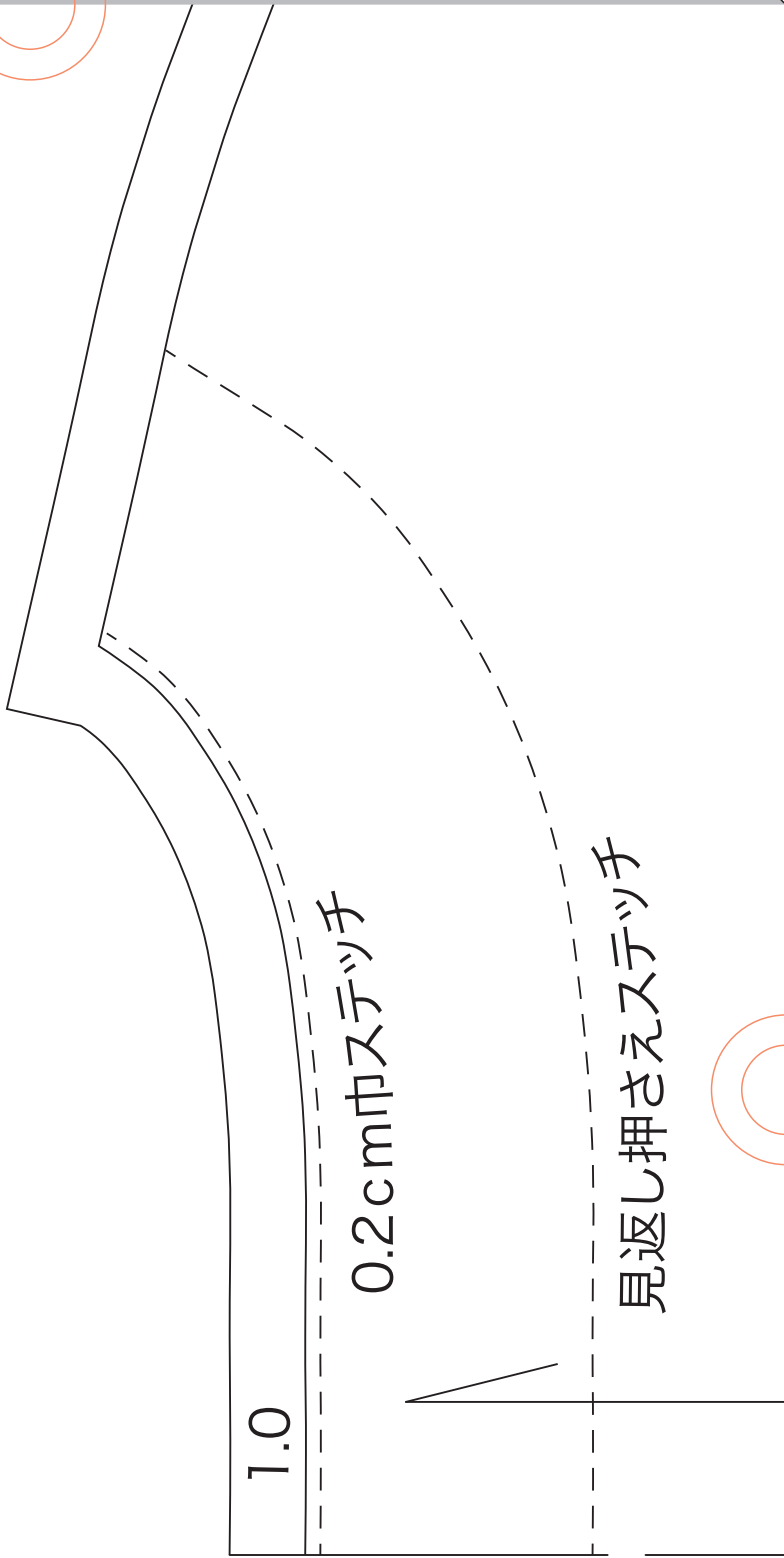

14

f a b f a b - 6

後身頃

size : 7

表×1枚

後身中心わ

15

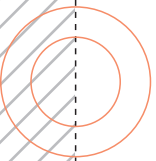
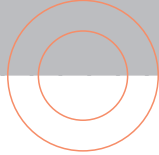



16

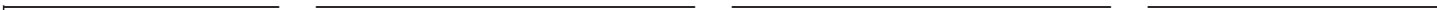
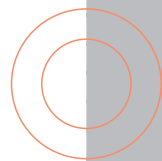
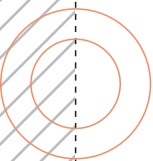
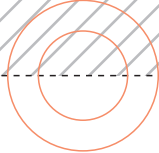

17

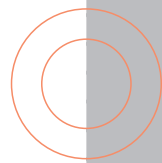
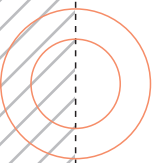
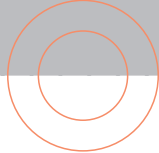

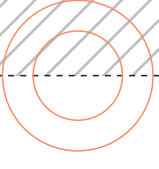

18

2.5cm幅三つ折りステッチ

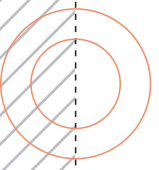

19

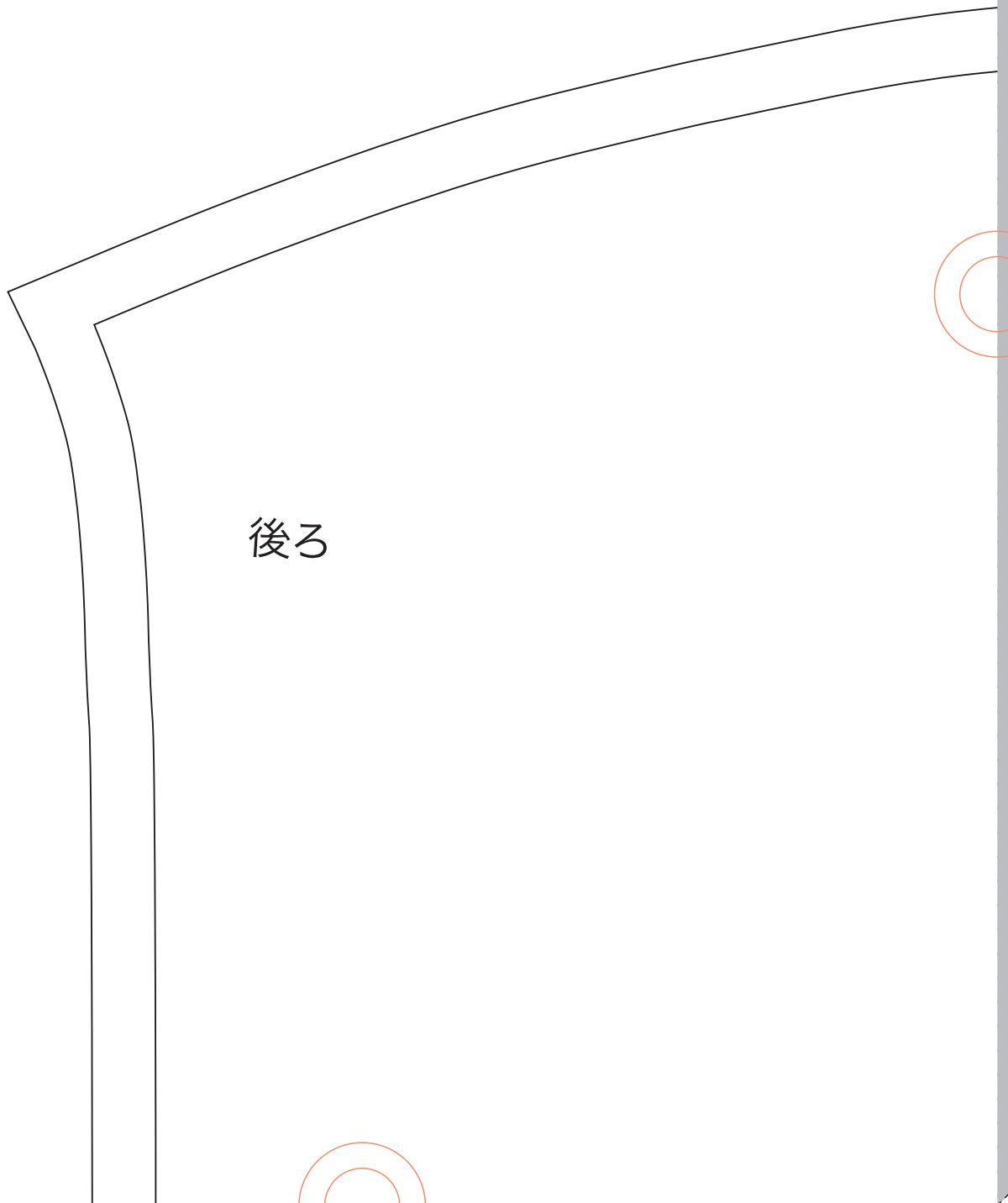

切り取る (斜線部はカット)

20

袖山

地の目線

f a b f a b - 6

袖

size : 7

表 × 2 枚

21

1.0

前

1.0

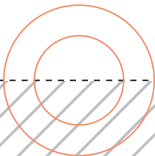
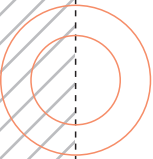

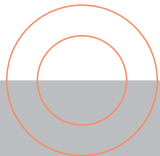
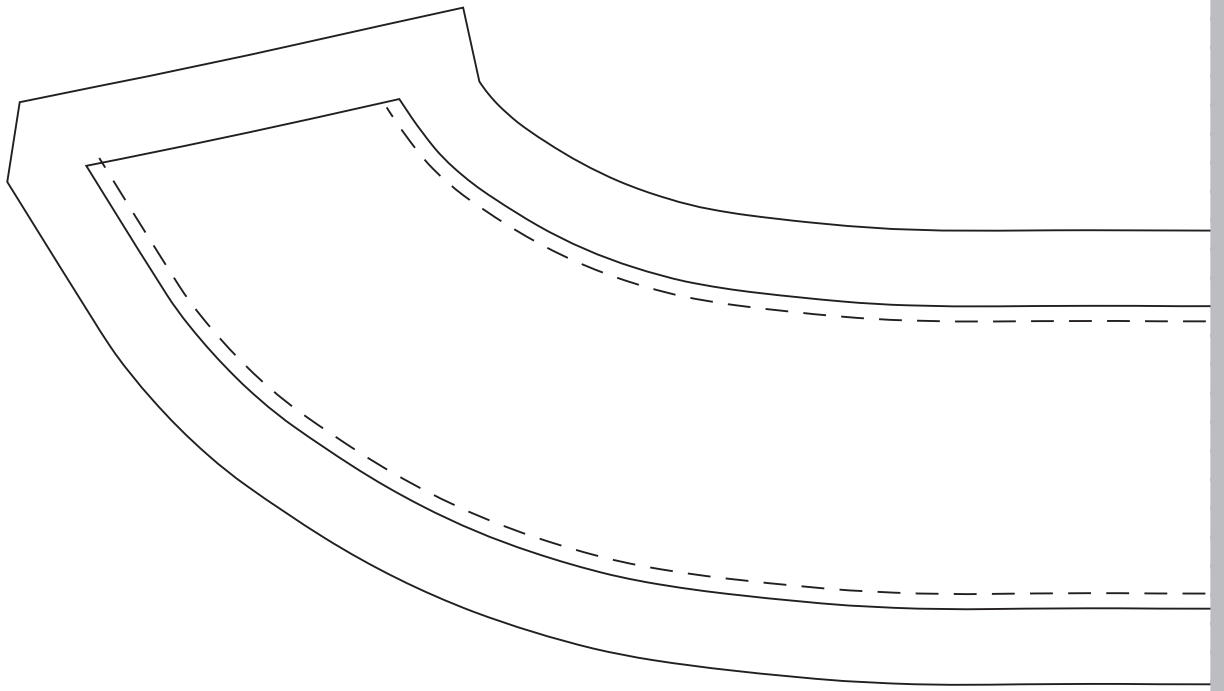
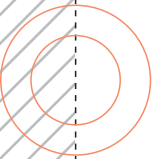

23

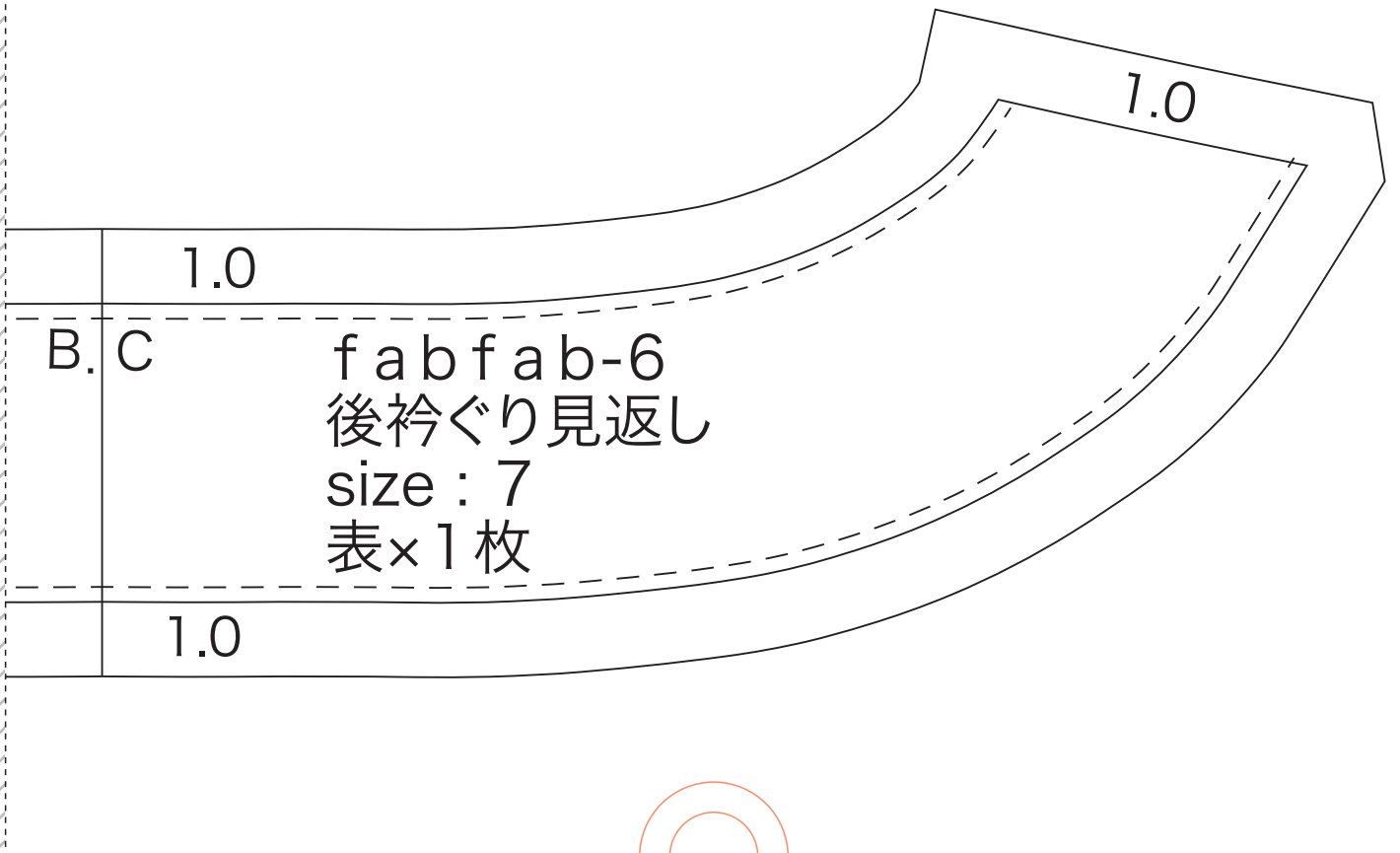



24

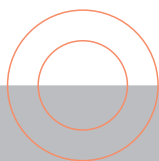
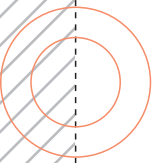

25

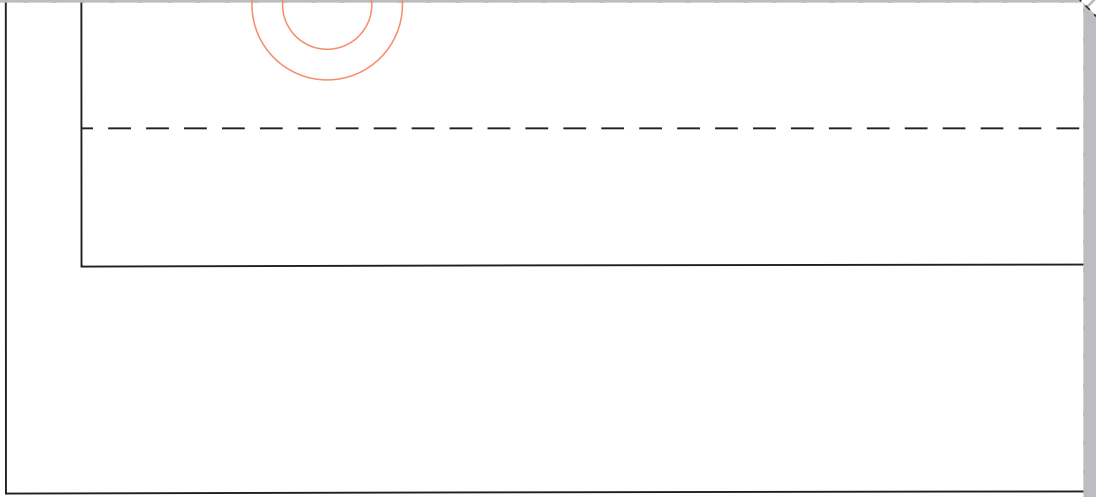

26

2cm幅三つ折りステッチ

fabfab-6	
ベルト通じ	
size: 7	
1.0	表×2枚

27

3.0

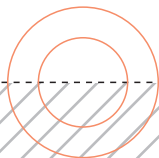
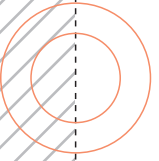
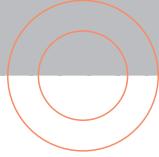

28

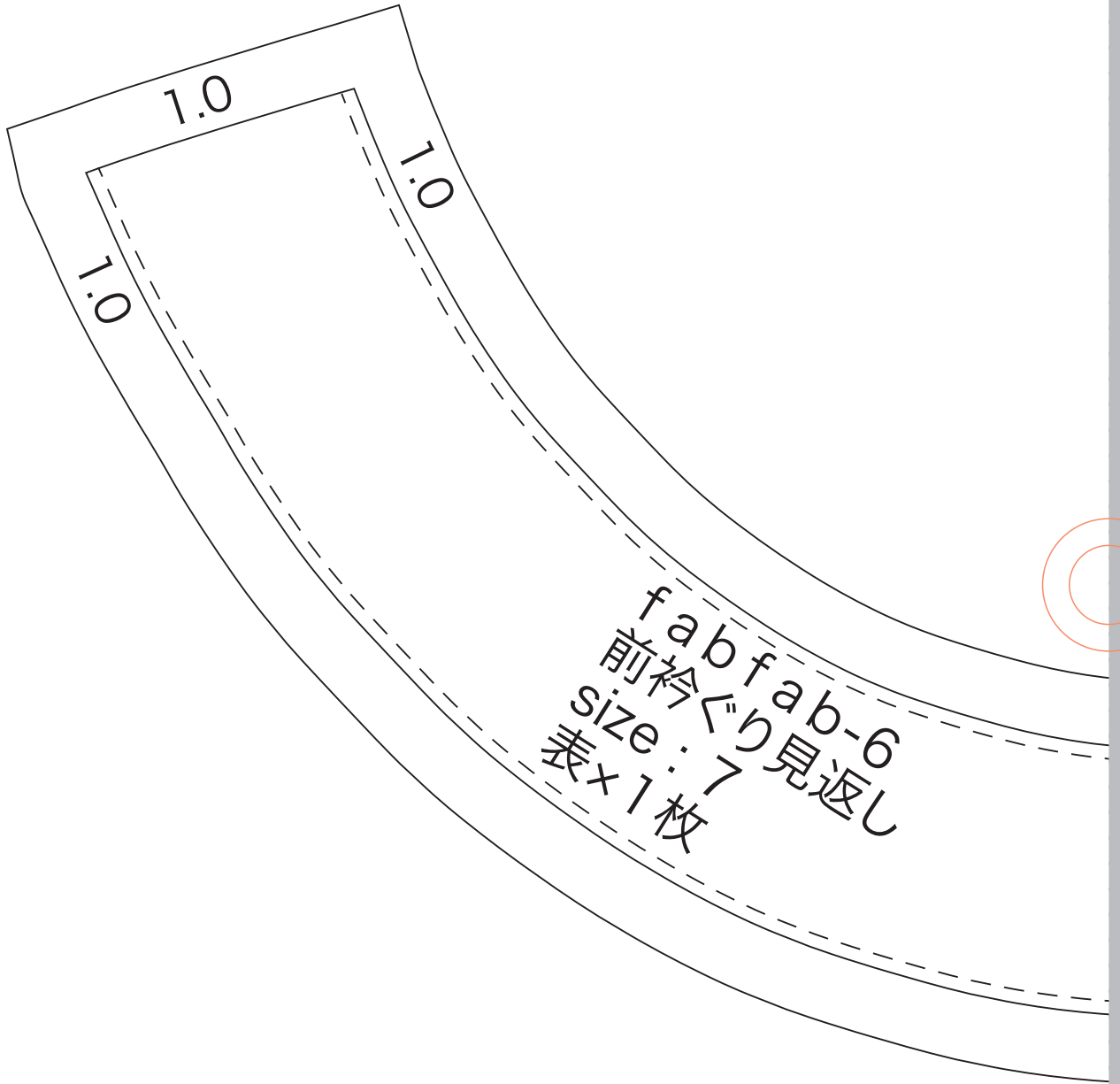

29

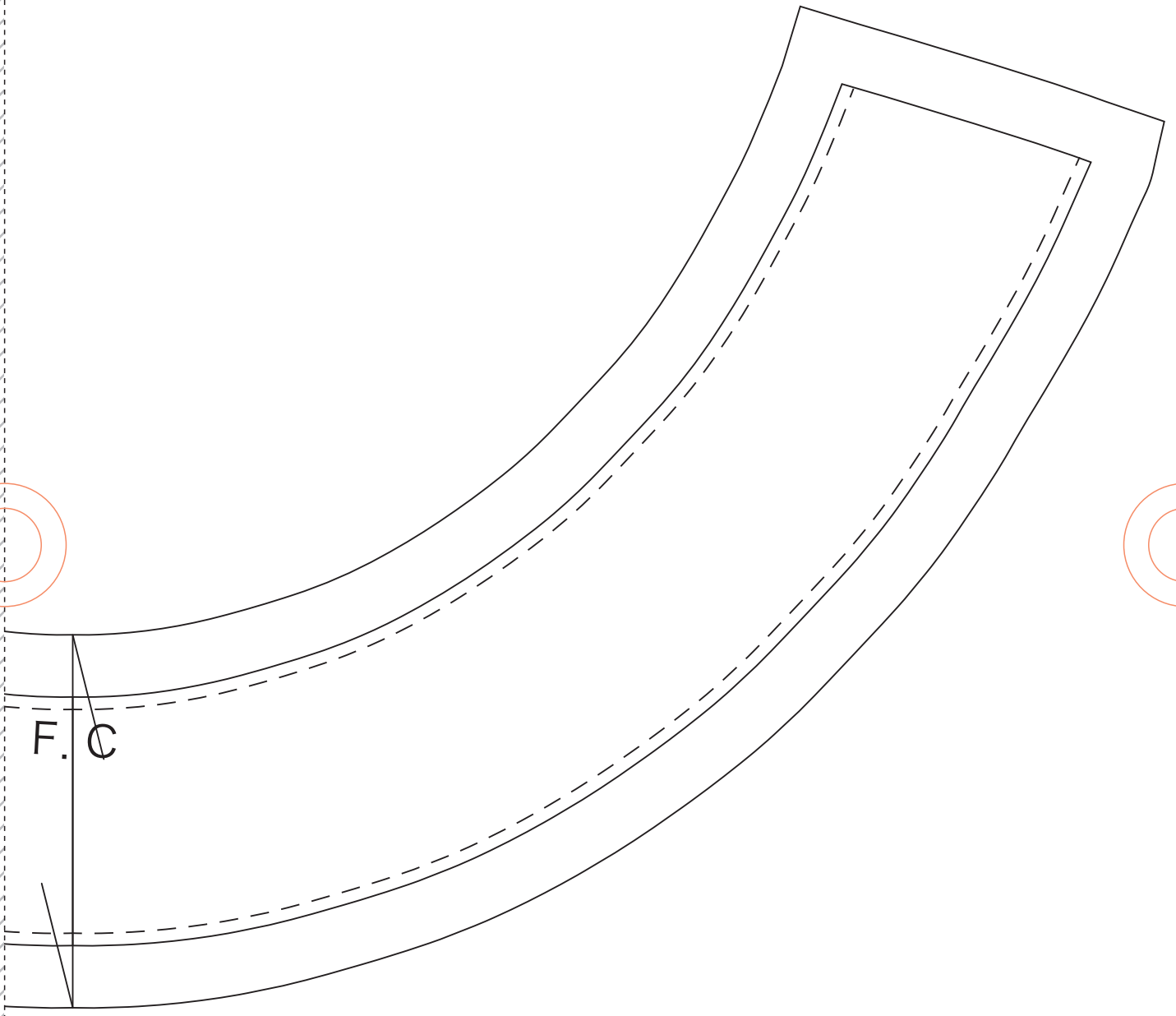

30

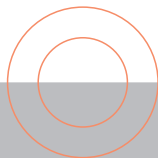
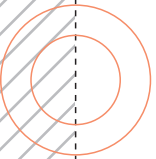
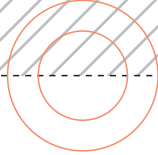

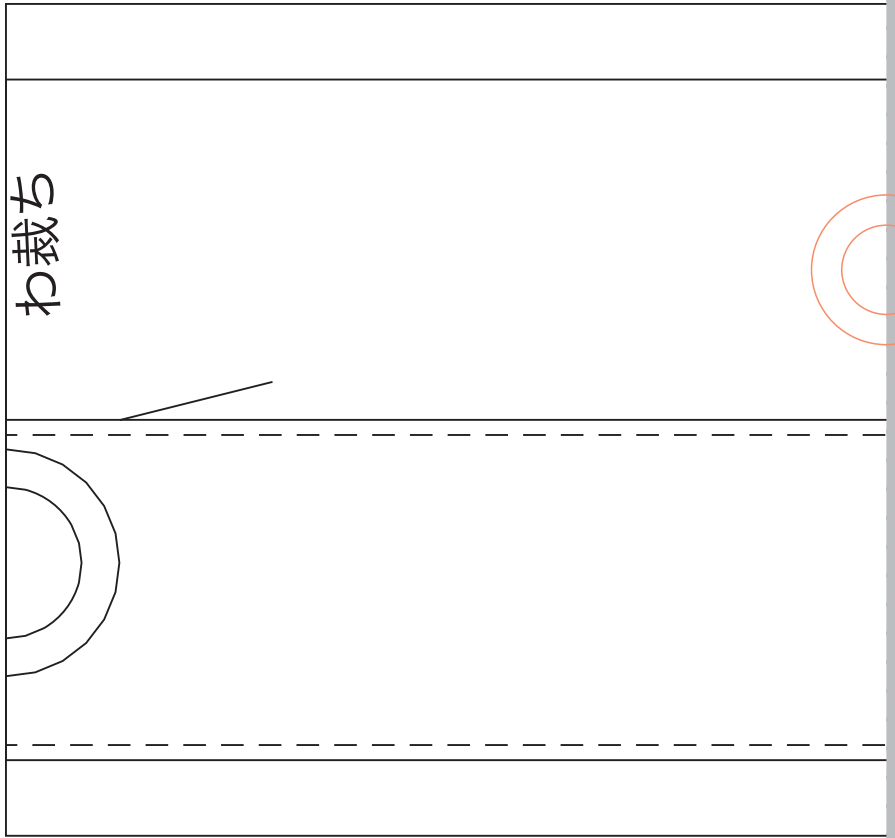
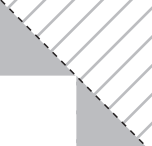
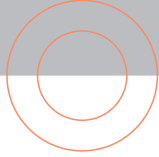



32

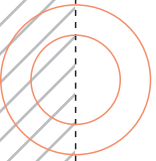
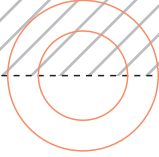

33

f a b f a b - 6  
ベルト  
size : 7  
表 × 1 枚

34

折山線

35

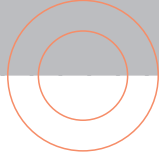

1.0

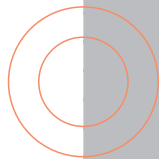
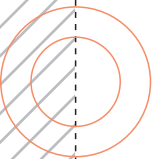

36

