

introduction はじめに

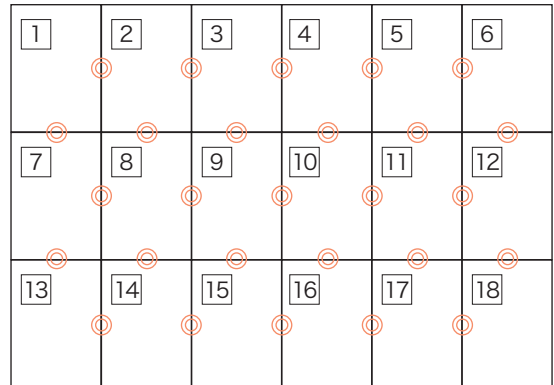

パターンは A4 サイズ 36 枚に分割されています。
印刷後、右図のようにつなぎ合わせてください。

! 印刷時の注意

印刷設定では、「ページの拡大や縮小」を選択せず
必ず、「実際のサイズ」(原寸) で印刷してください。



how to make パターンのつくりかた

STEP1 斜線部分  は切り取り、灰色部分  は残してのりしろにします。
(斜線と灰色を間違えないように注意)

STEP2 各用紙の番号を確認し、 の位置を合わせて、のりつけします。
(水のりは用紙が波打ちます。スティック糊などをお使いください)

STEP3 それぞれのパーツをハサミで切り出します。

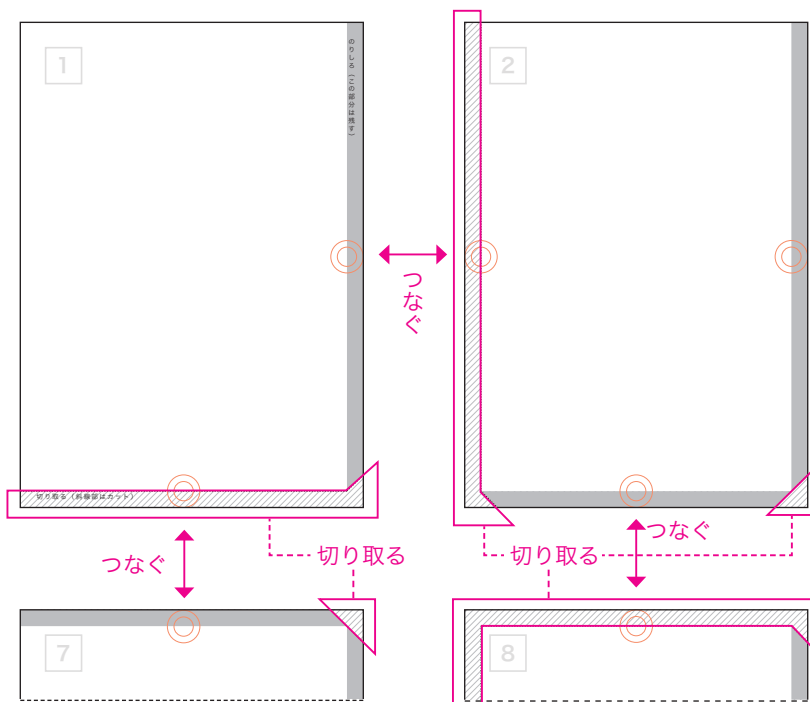
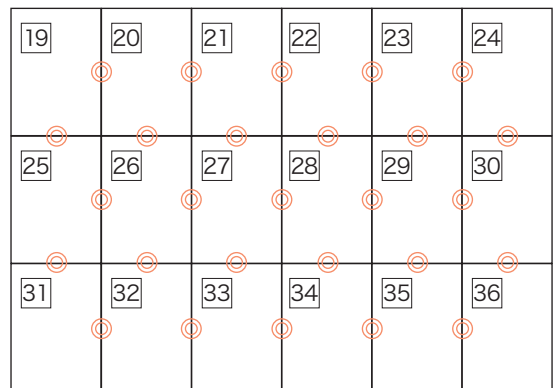

1

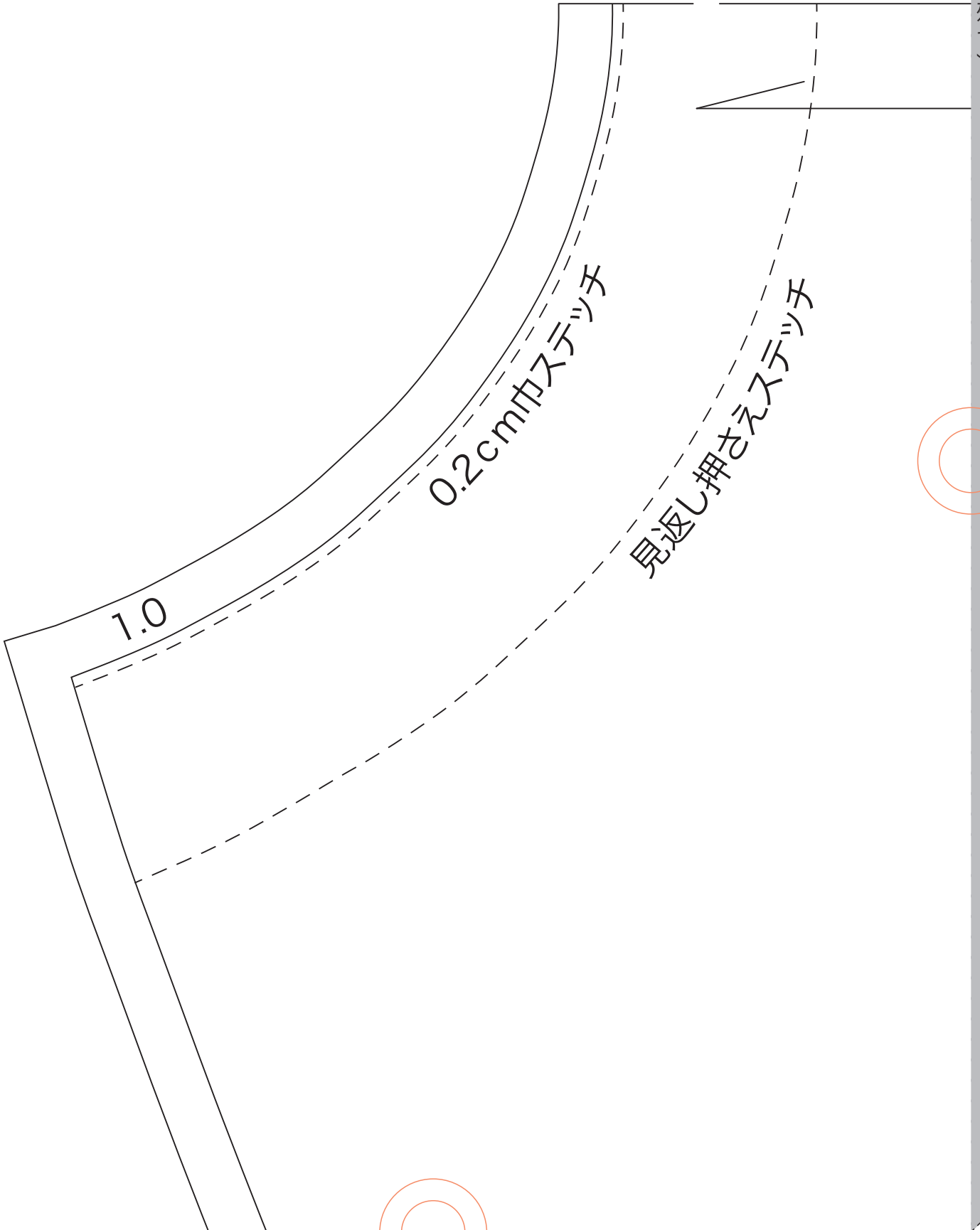

切り取る (斜線部はカット)

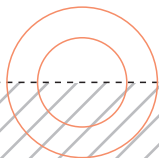

2

前中心カ

f a b f a b - 6

前身頃

size : 9

表×1枚

3

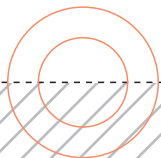
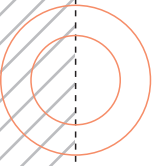

4

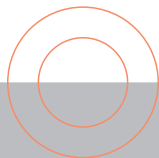
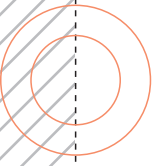

5

2.5cm幅三つ折りステッチ

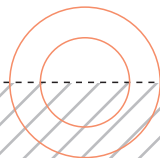
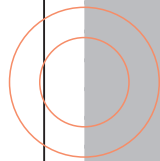
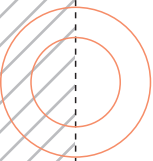

6

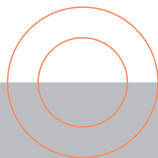
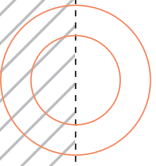

7

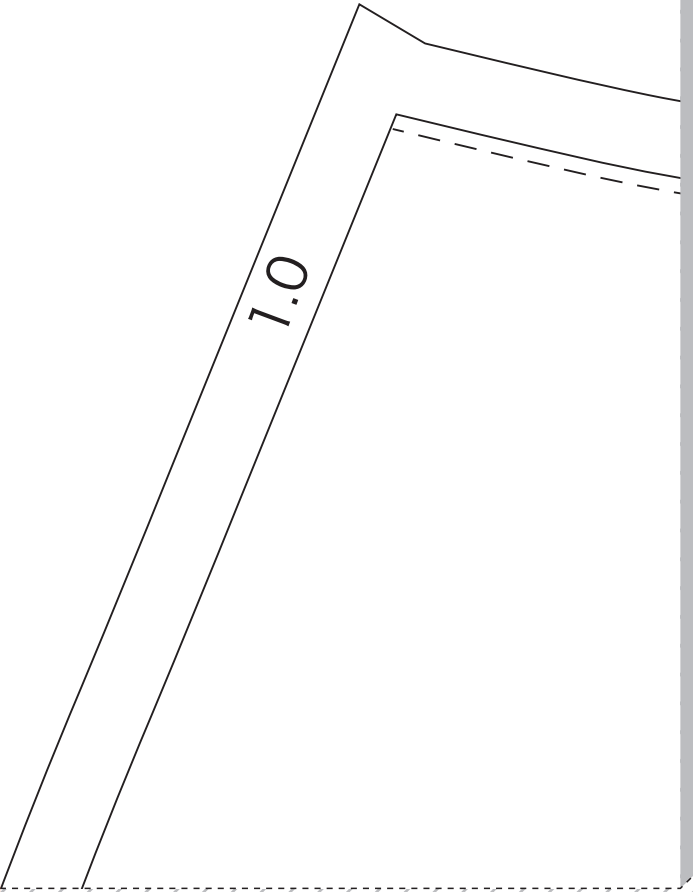
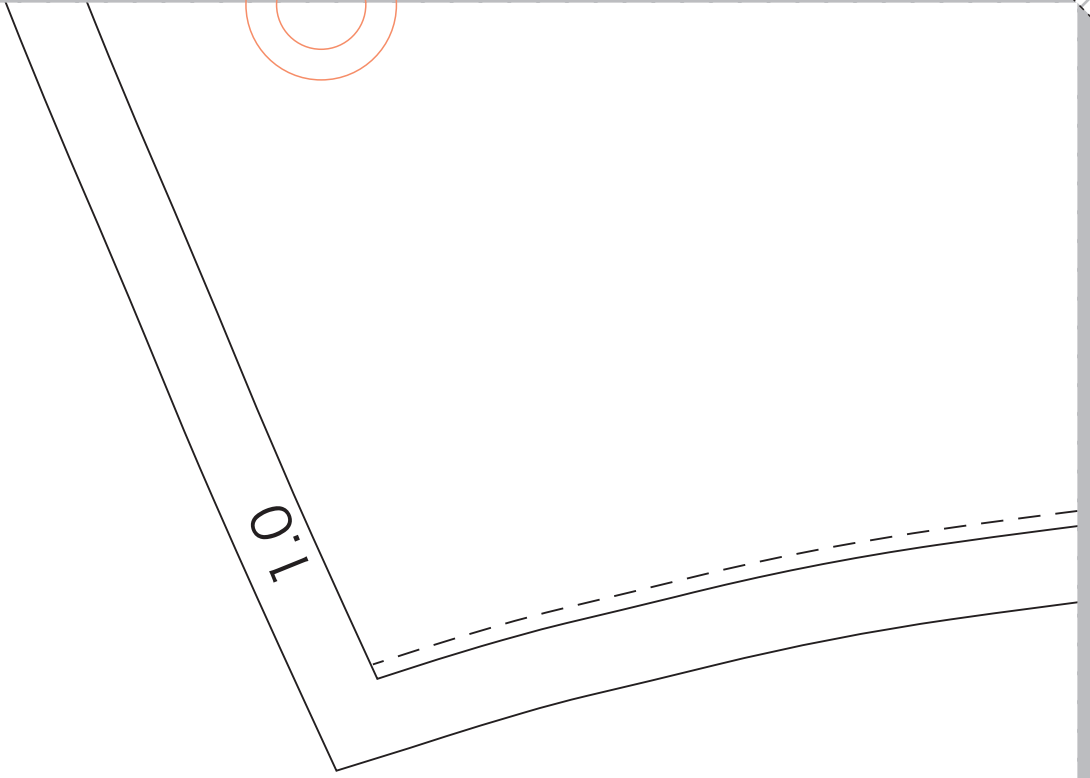
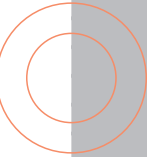
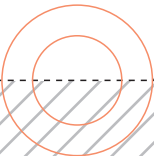
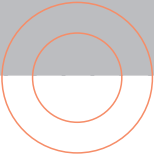

8

0.1

1.0

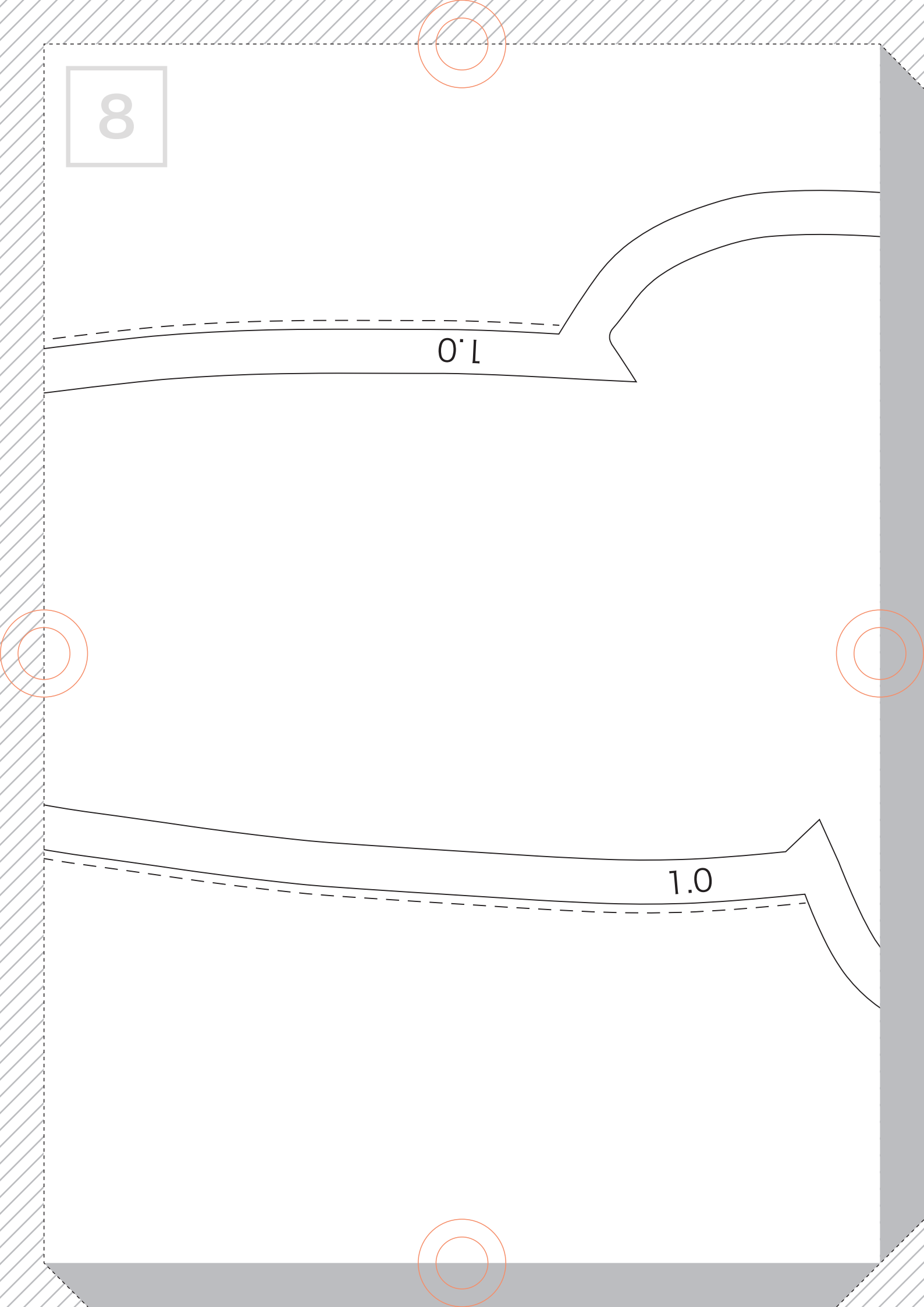

9

1.0

1.0

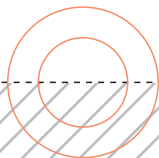
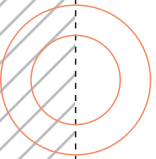
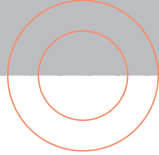

10

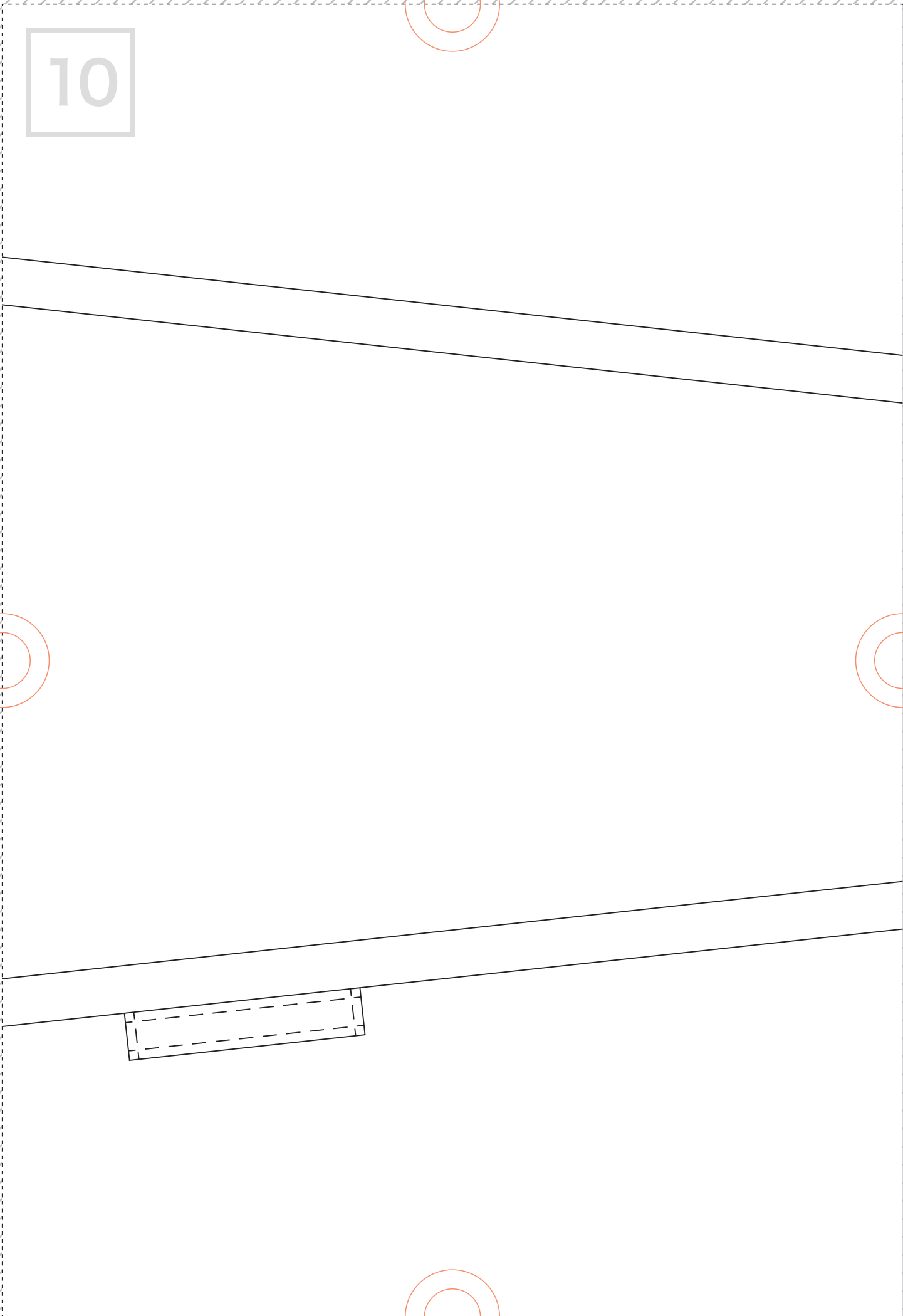
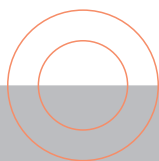
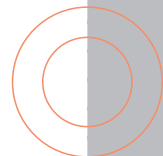
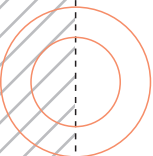
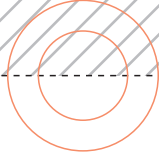

11

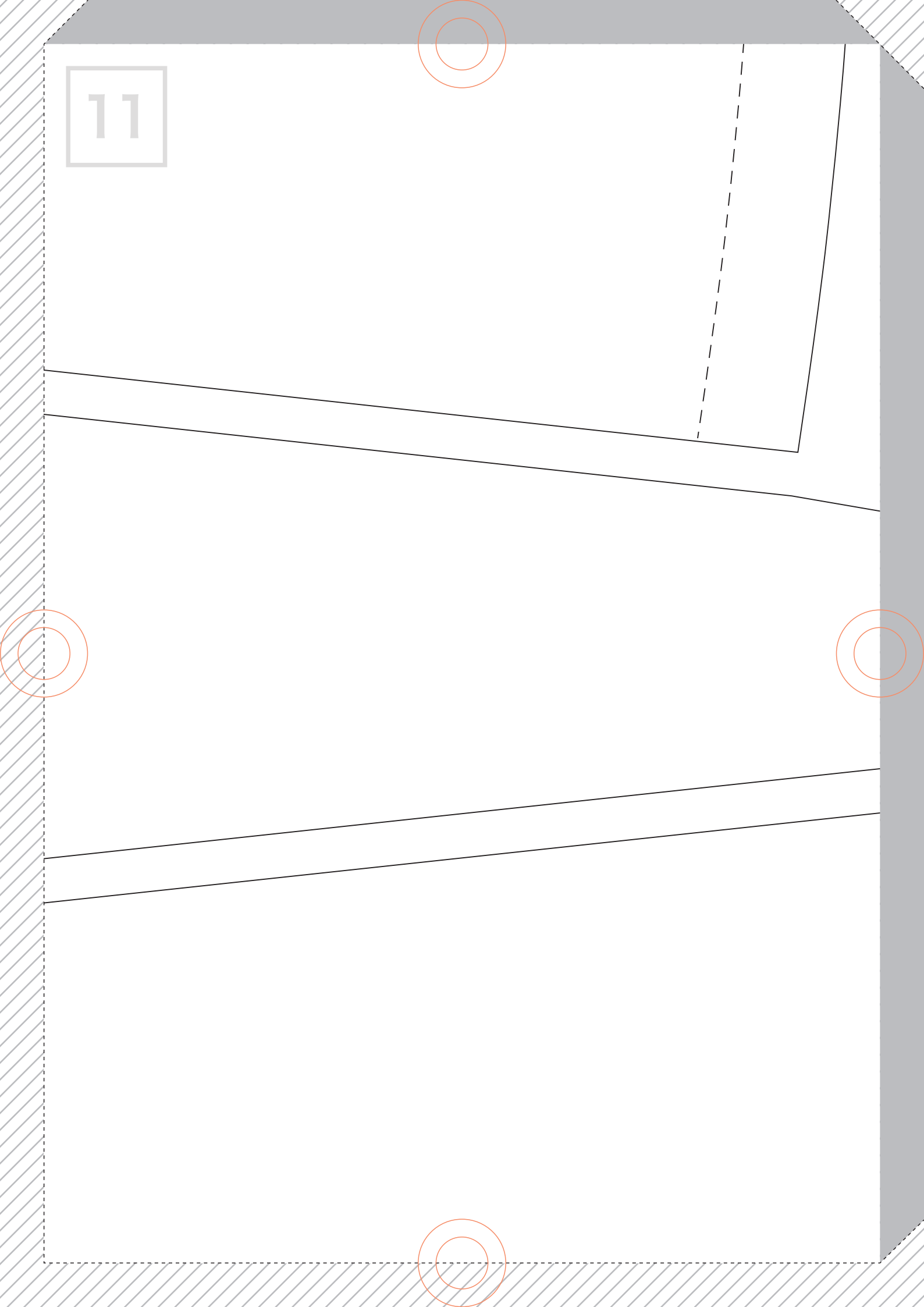
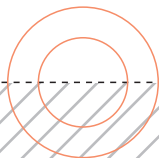
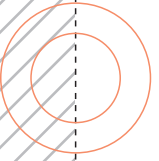
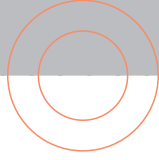

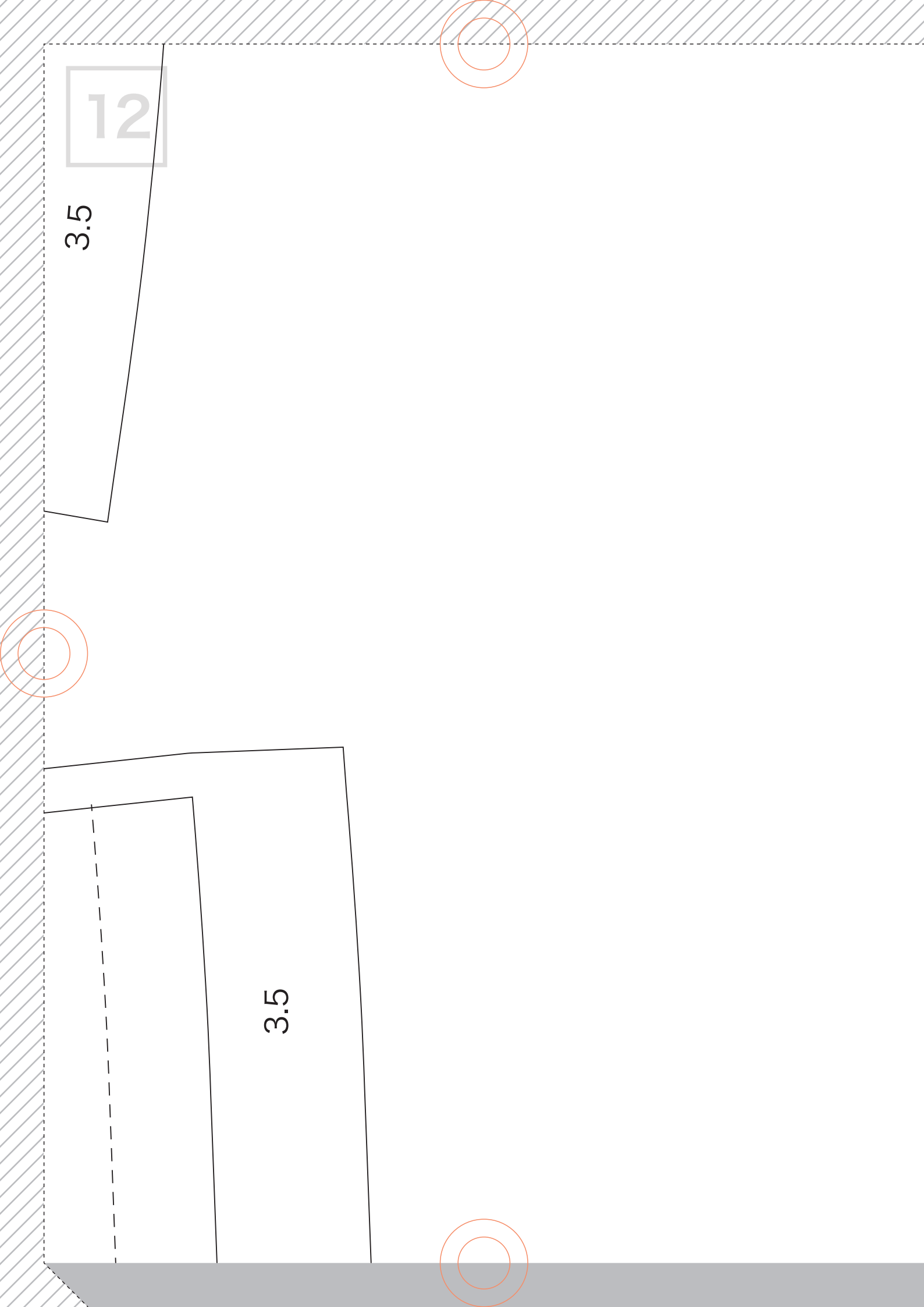

12

3.5

3.5

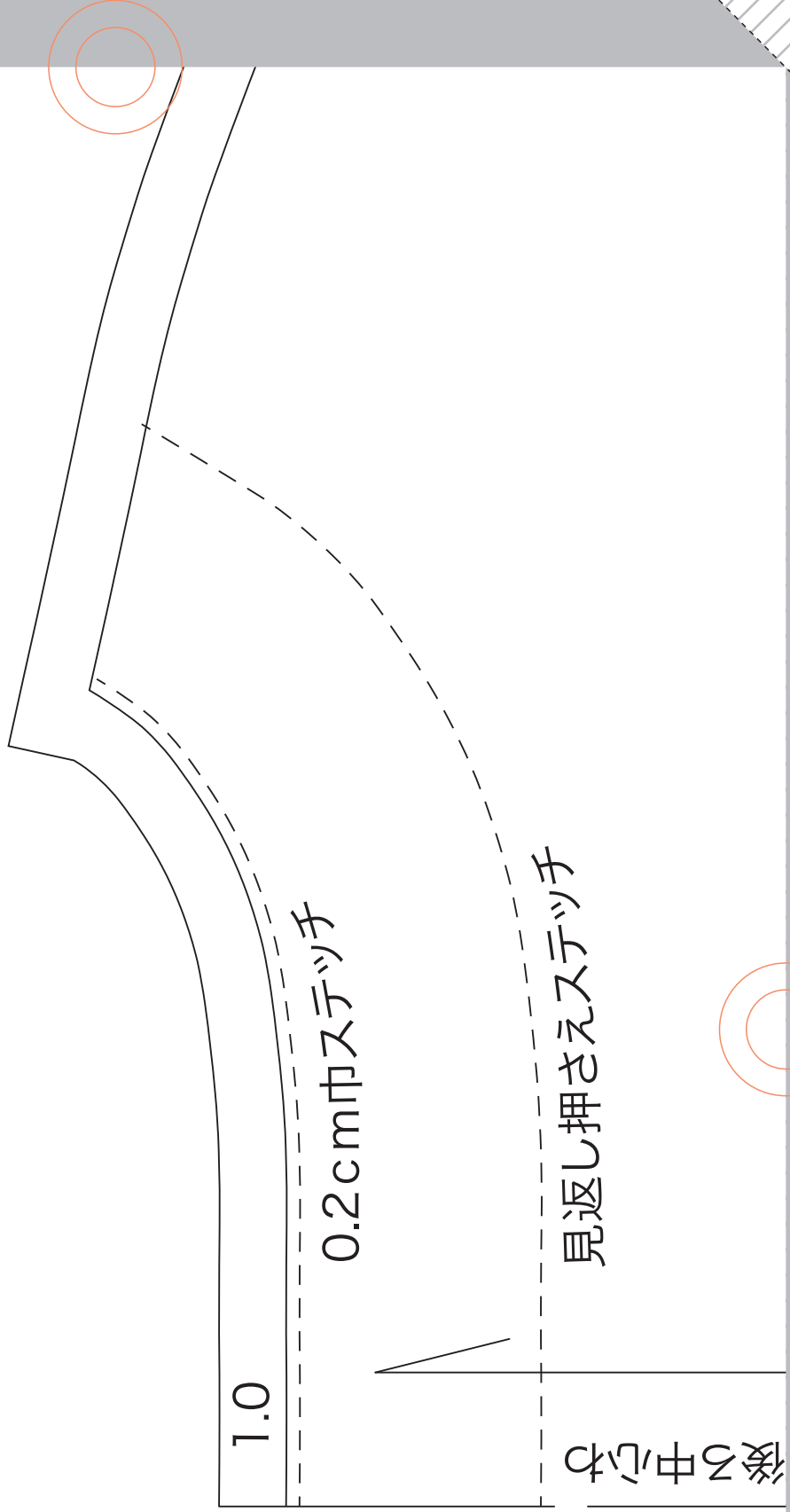

14

f a b f a b - 6

後身頃

size : 9

表×1枚

15

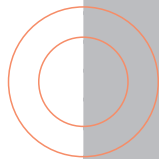
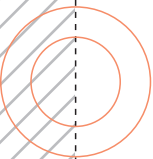
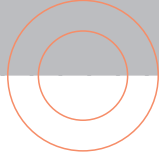

16

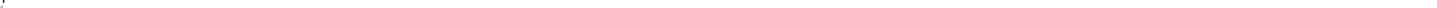
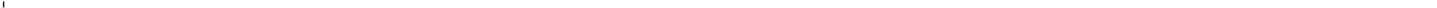
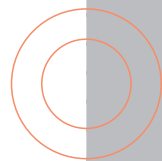
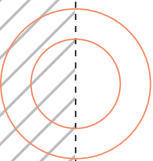
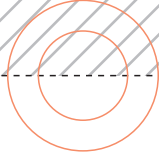

17

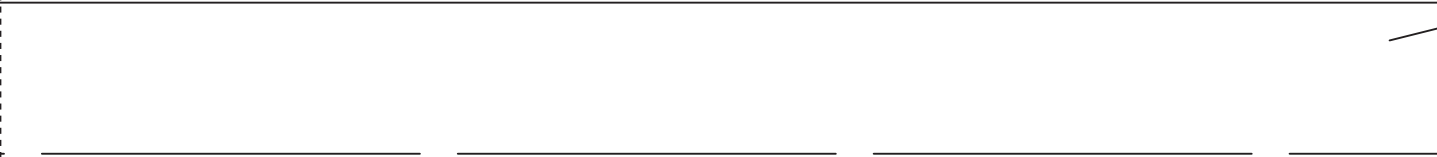
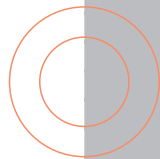
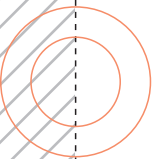
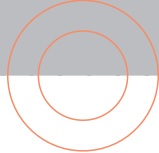

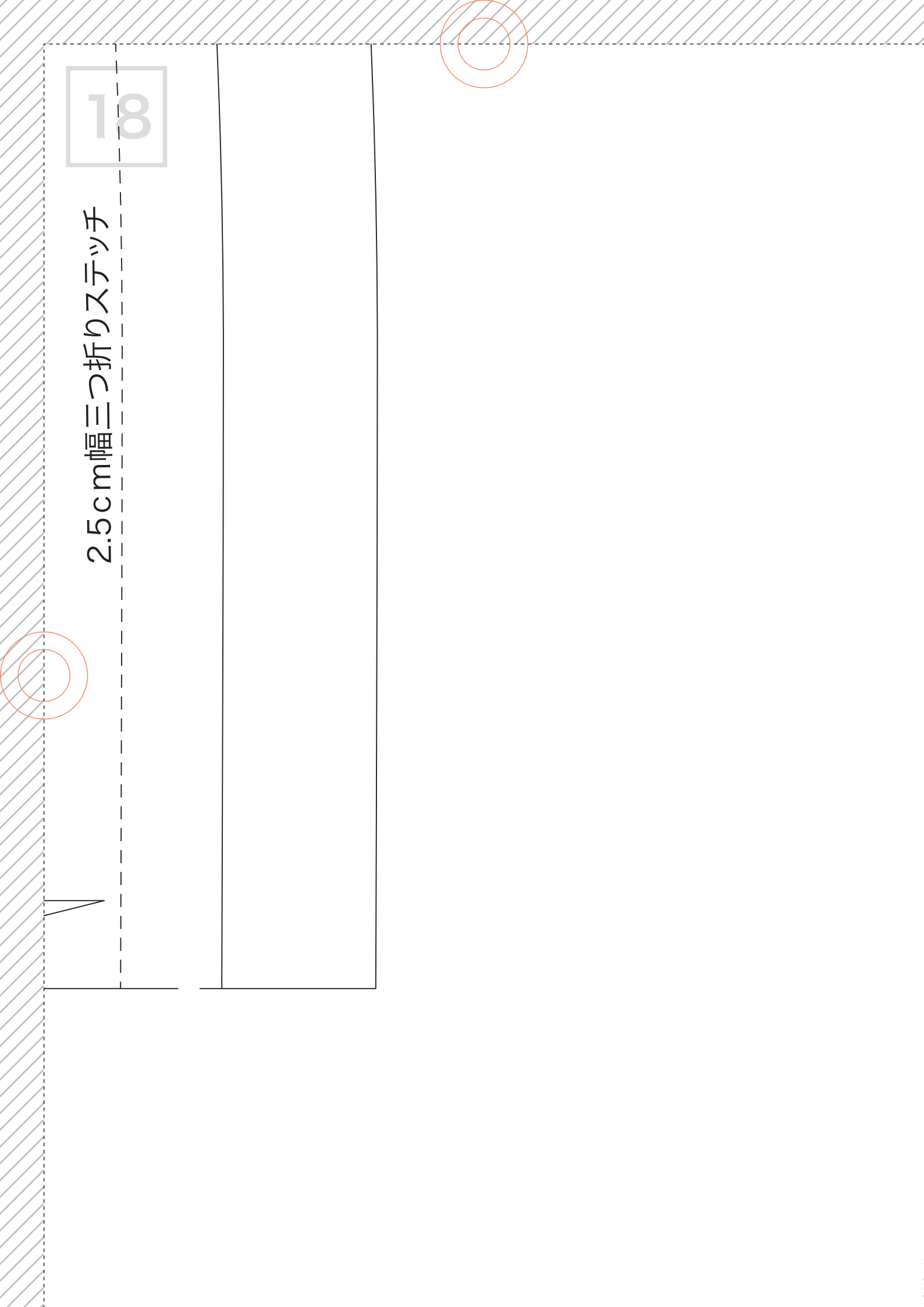

18

2.5cm幅三つ折りステッチ

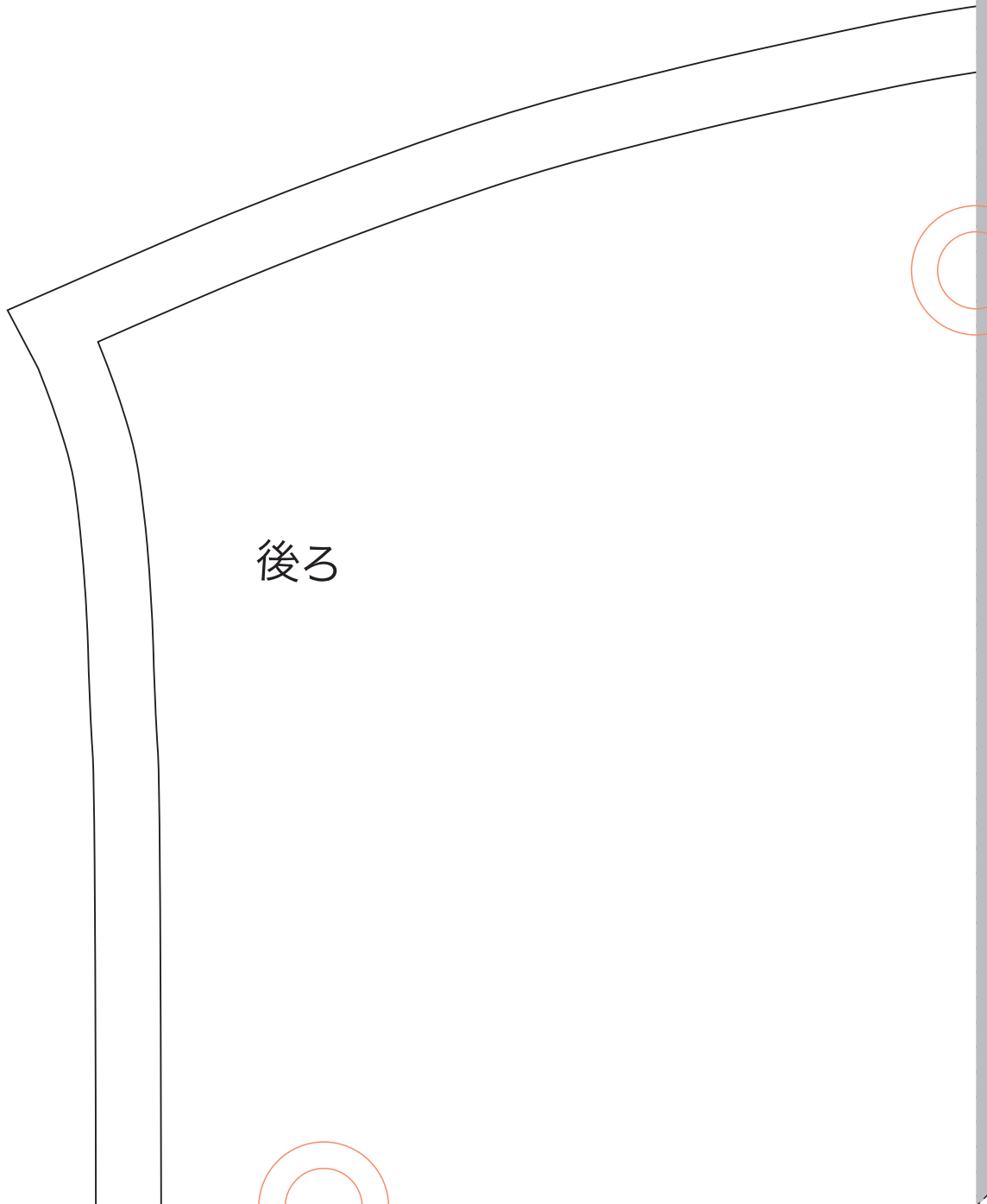

後ろ

切り取る (斜線部はカット)

20

袖山

地の目線

f a b f a b - 6

袖

size : 9

表 × 2 枚

21

1.0

前

1.0

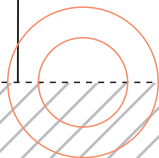
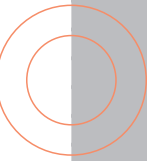
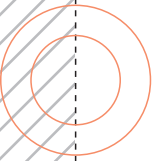

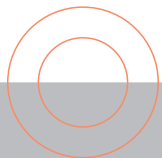
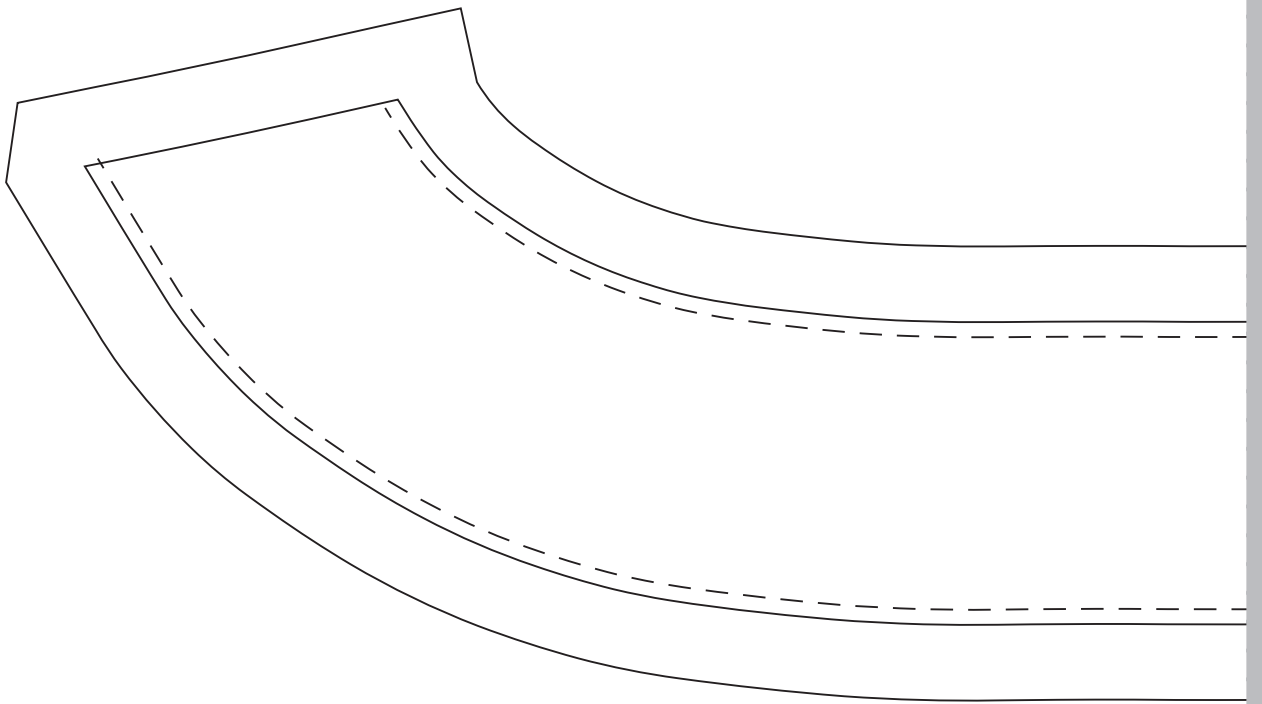
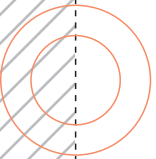

23



24

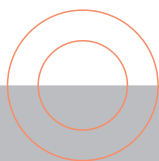
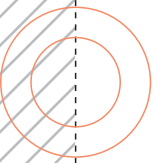

25

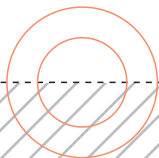
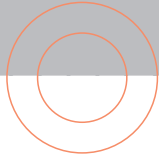

26

2cm幅三つ折りステッチ

	f a b f a b - 6		
	ベルト通し		
	size : 9		
1.0	表×2枚		

27

3.0

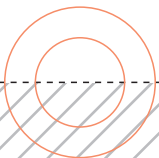
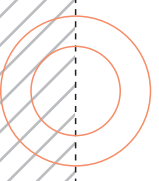
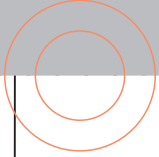

28

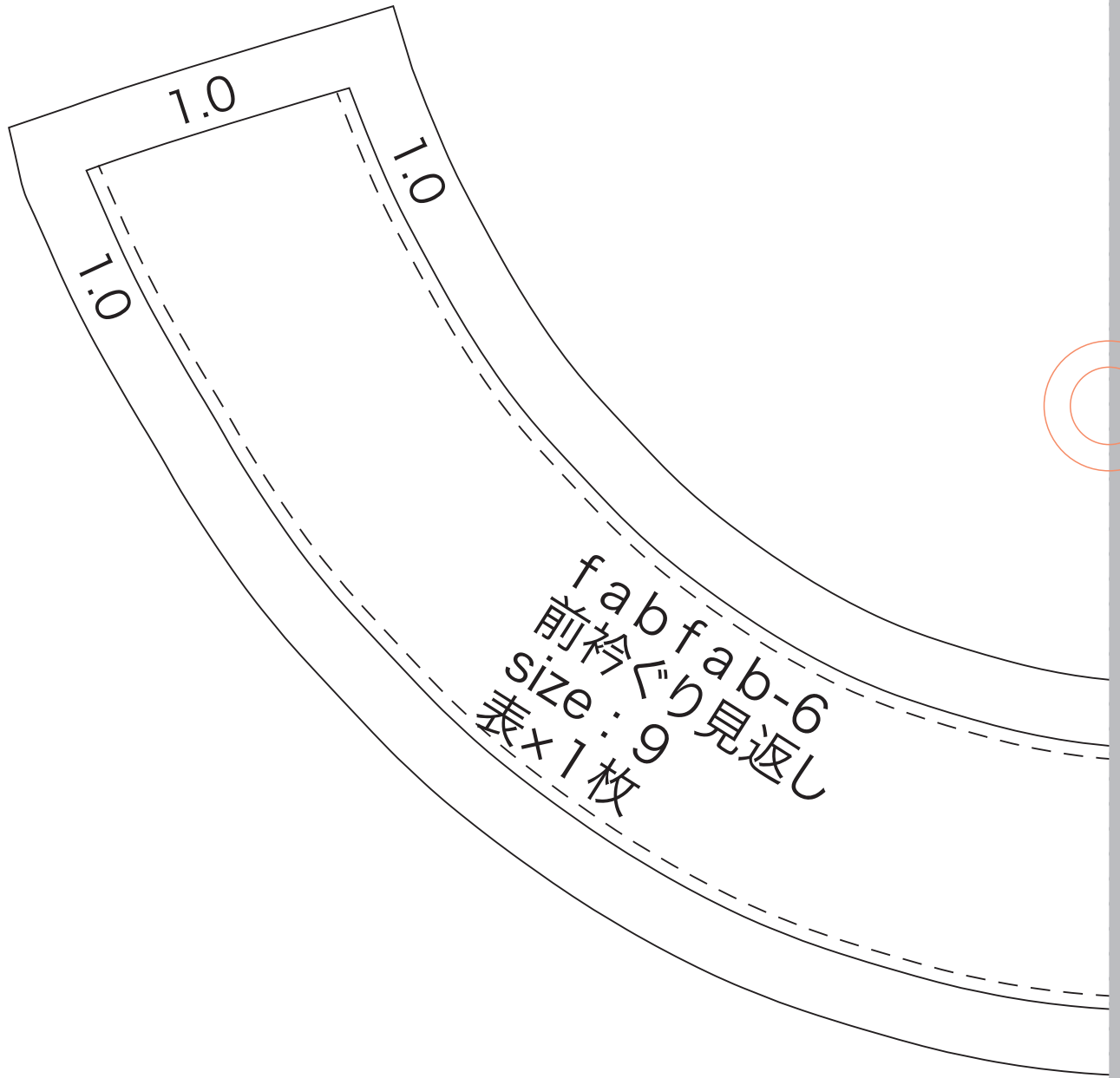

fabfab-6
前衿ぐり見返し
size: 9
表×1枚

29

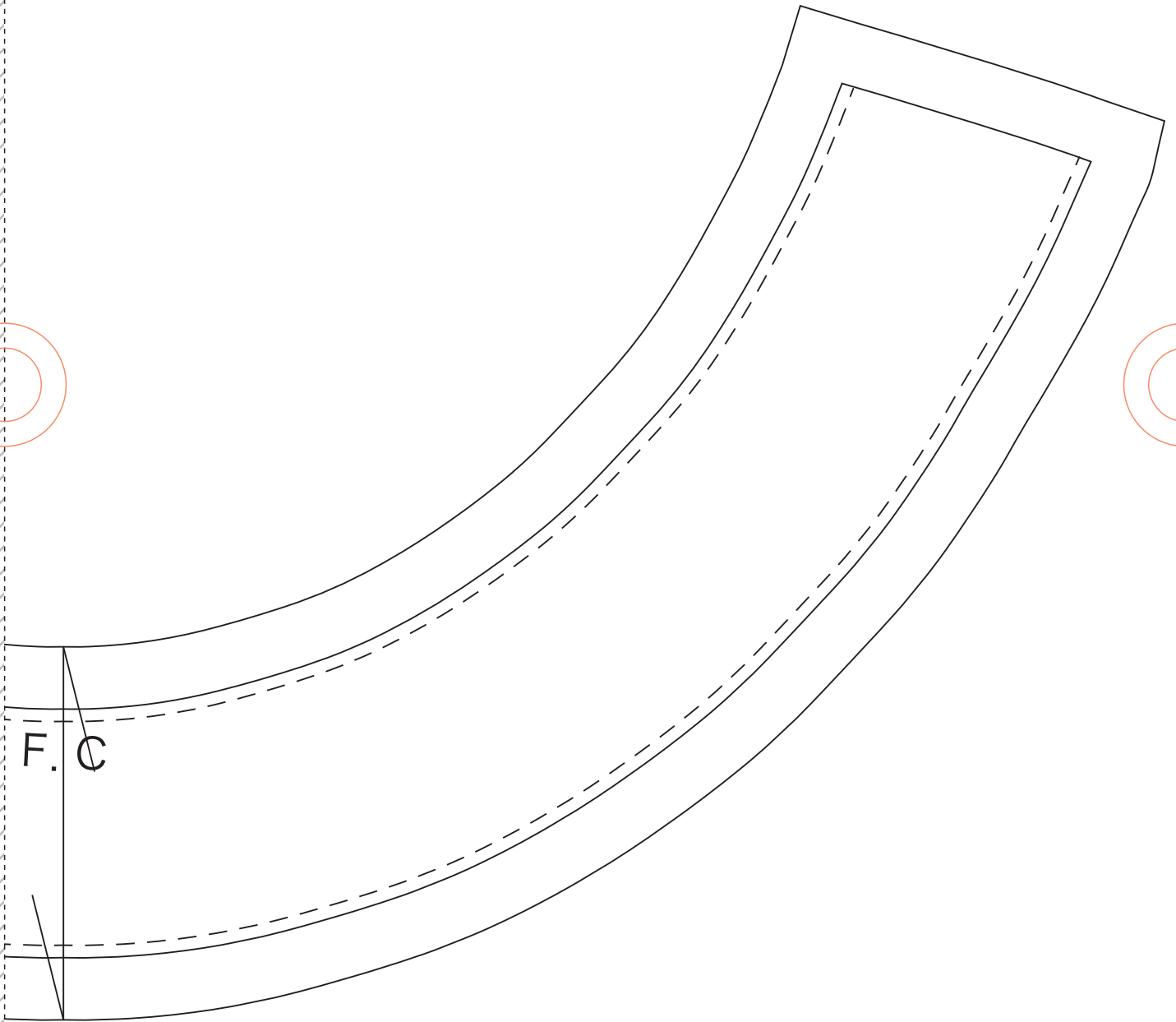

30

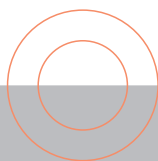
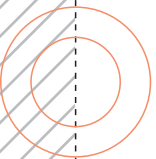
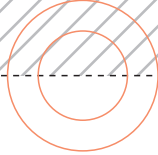

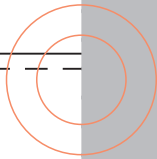
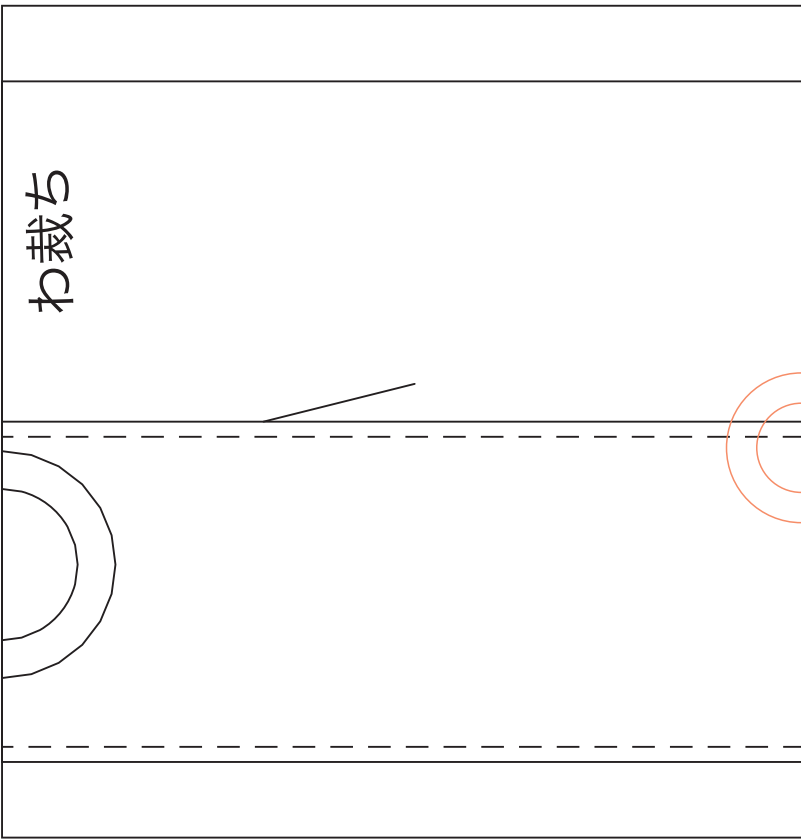

32

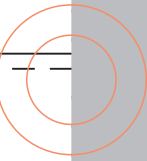
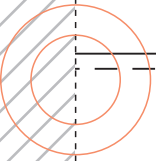
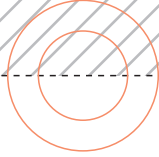

33

f a b f a b - 6

ベルト

size : 9

表 × 1 枚

34

折山線

35

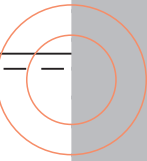
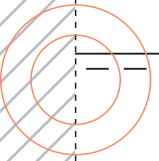
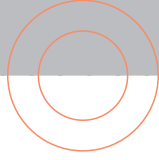

36

1.0

