



introduction はじめに

パターンは A4 サイズ 54 枚に分割されています。
印刷後、右図のようにつなぎ合わせてください。

! 印刷時の注意

印刷設定では、「ページの拡大や縮小」を選択せず
必ず、「実際のサイズ」(原寸) で印刷してください。

how to make パターンのつくりかた

STEP1 斜線部分  は切り取り、灰色部分  は残してのりしろにします。
(斜線と灰色を間違えないように注意)

STEP2 各用紙の番号を確認し、 の位置を合わせて、のりづけします。
(水のりは用紙が波打ちます。スティック糊などをお使いください)

STEP3 それぞれのパーツをハサミで切り出します。

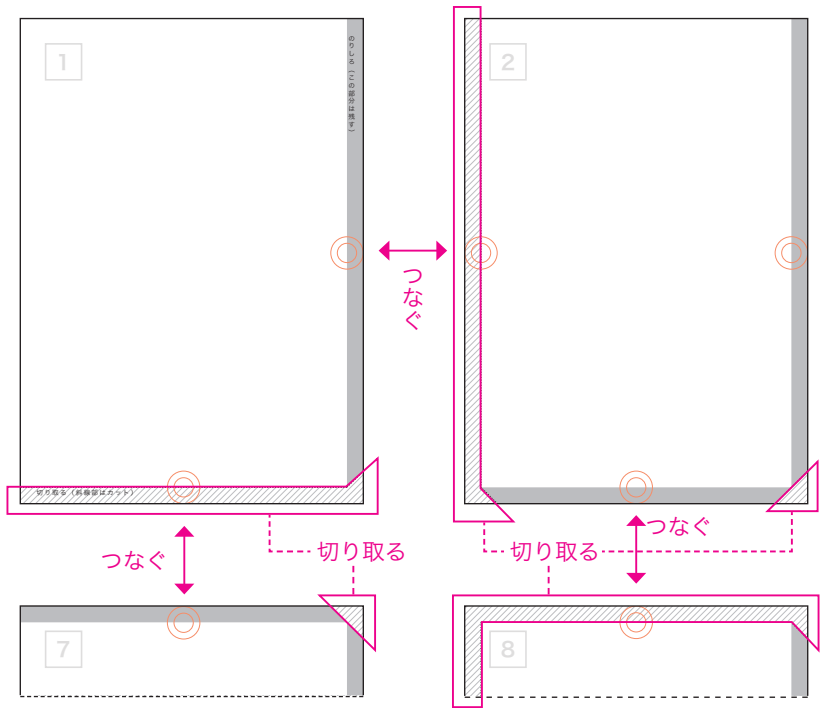
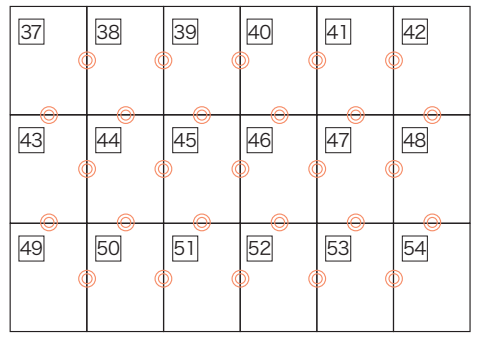
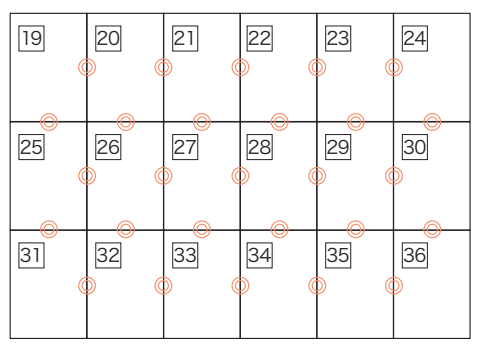
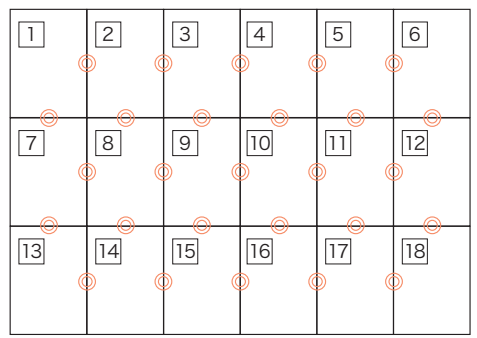

のりしろ (この部分は残す)

1

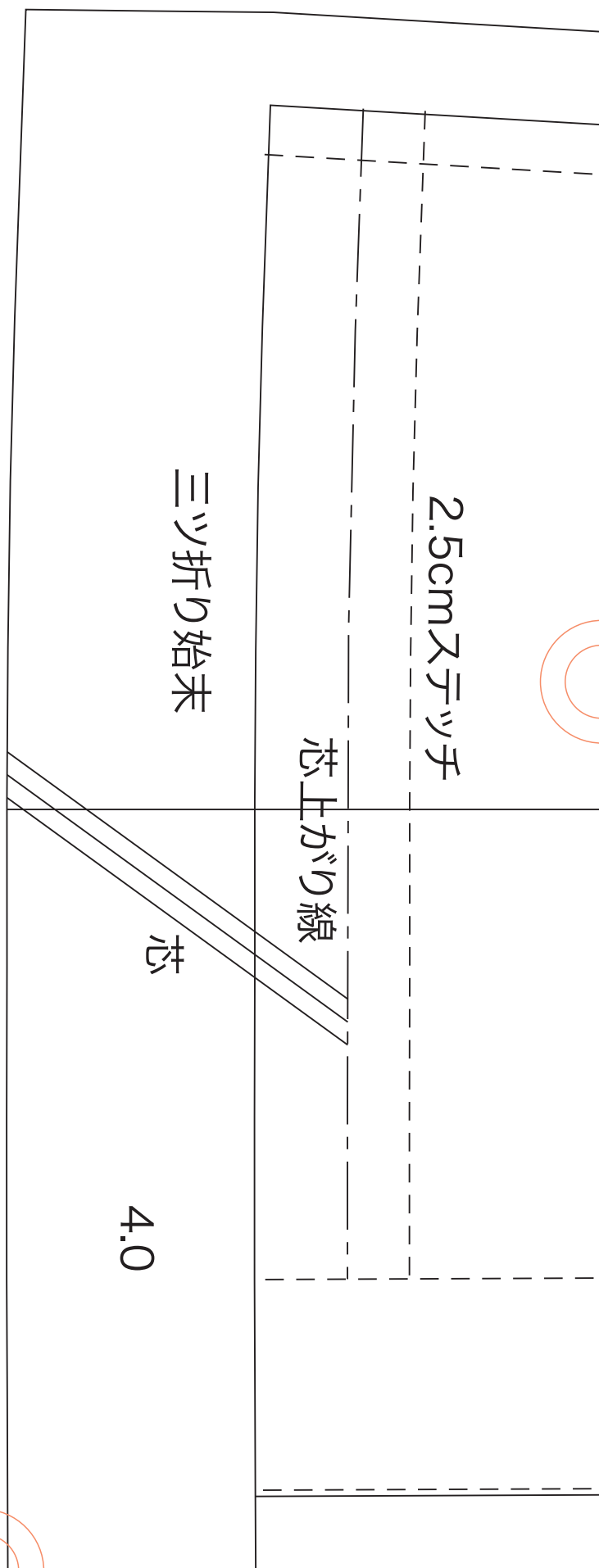

切り取る (斜線部はカット)

2

ベツ持ち出し押さえテツチ

松

コバステツチ

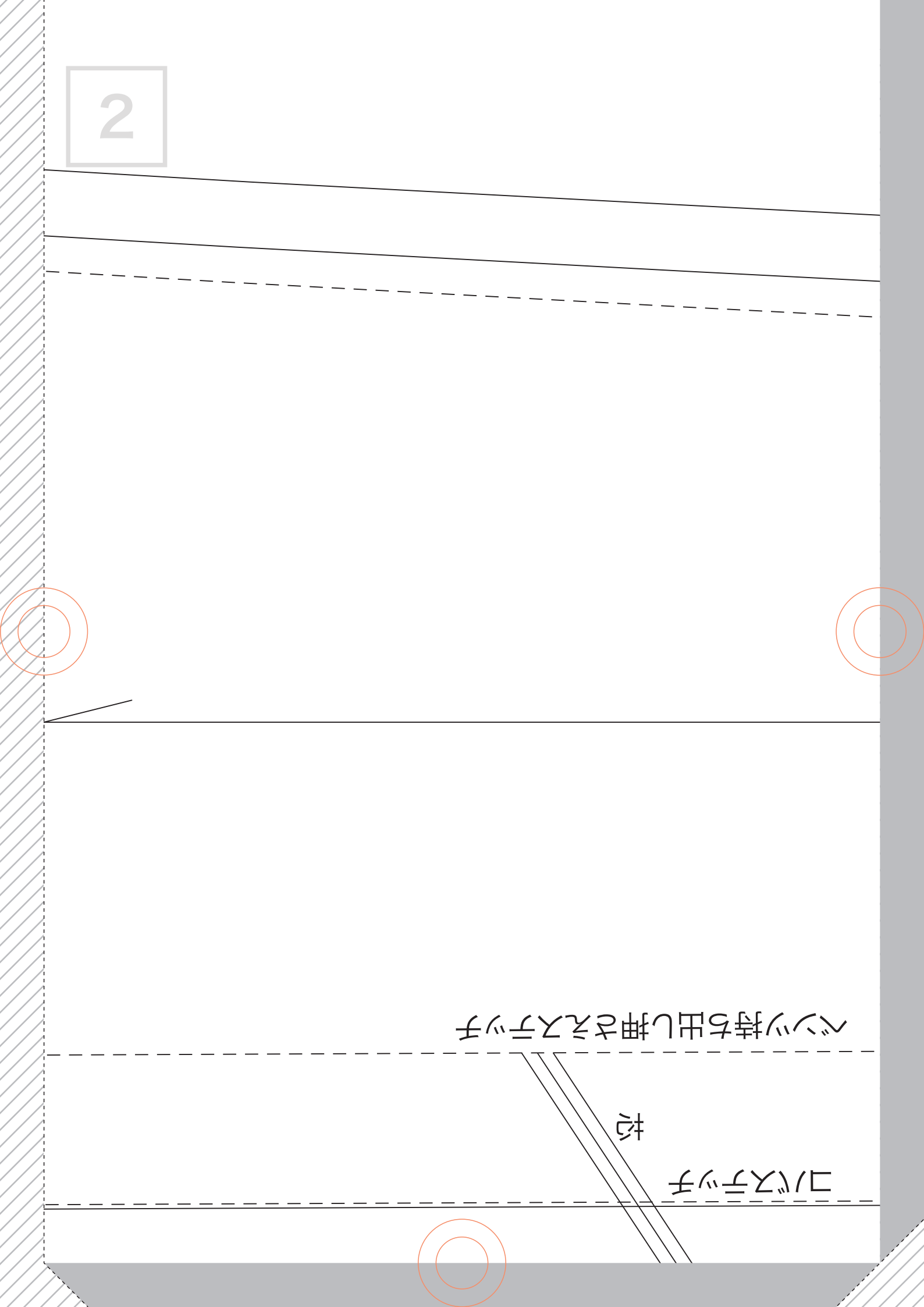

3

折り伏せ始末

折る

1.0

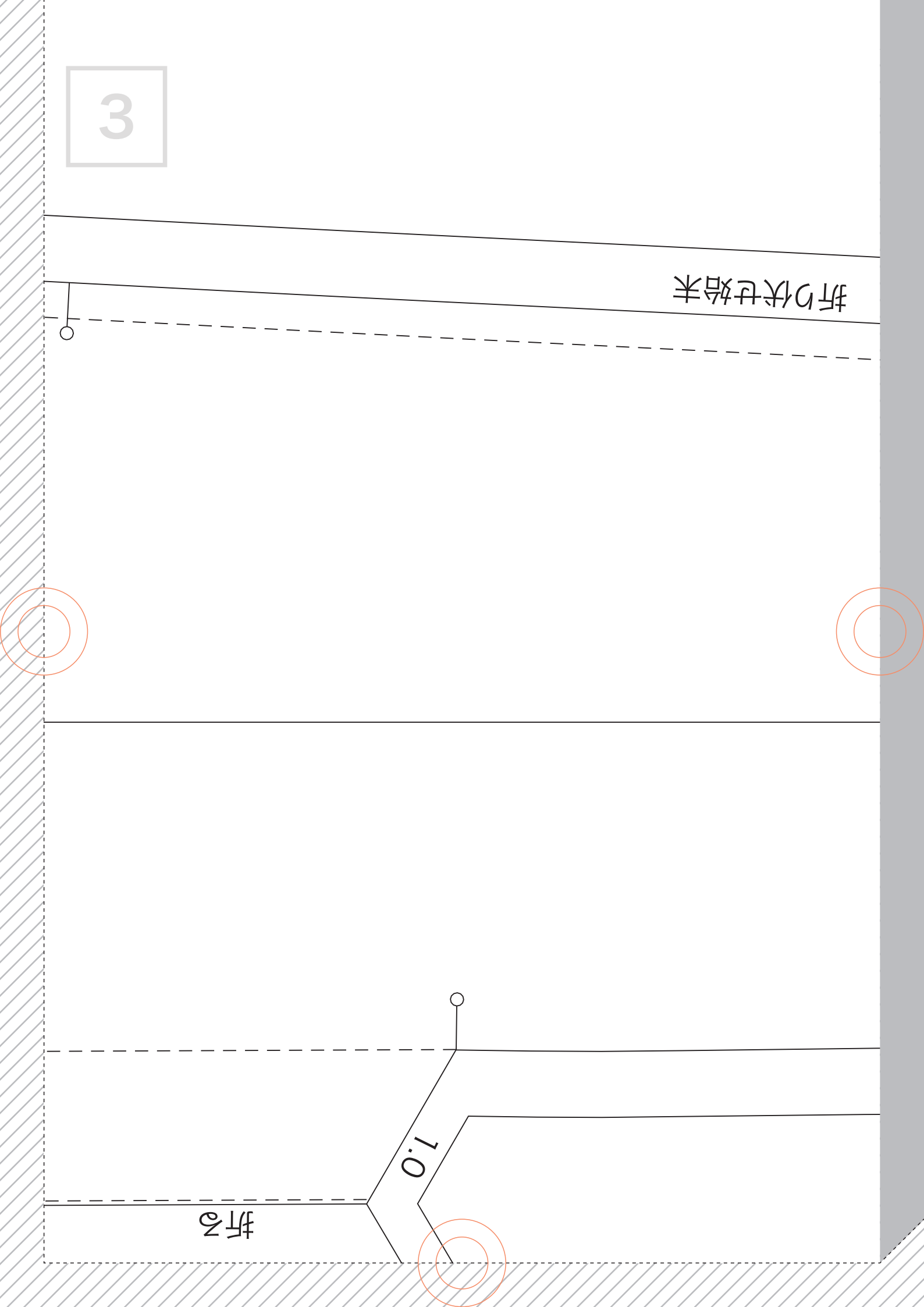
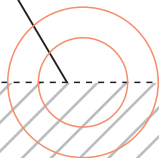
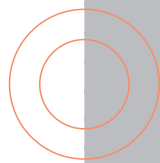
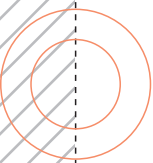

4

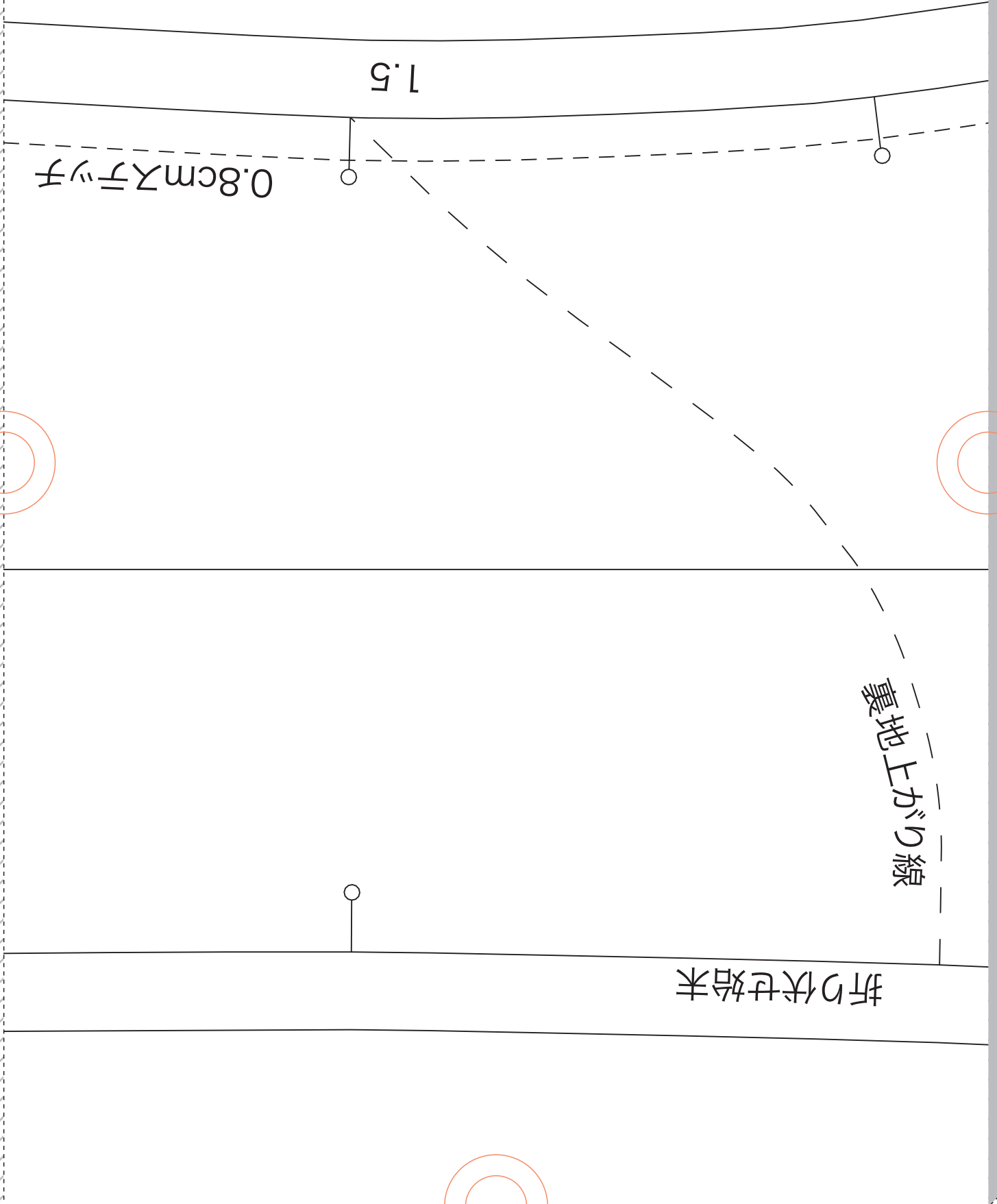

5

1.0

f a b f a b - 1 3
左後身頃
size : 1 1
表 × 1 枚

B · C

1.5

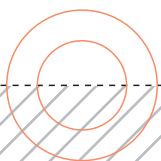
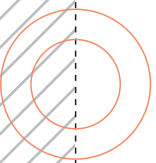

6

折り伏せ始末

1.5

0.8cmステッチ

0.5cmステッチ

1.0

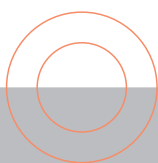
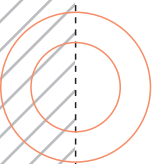

7

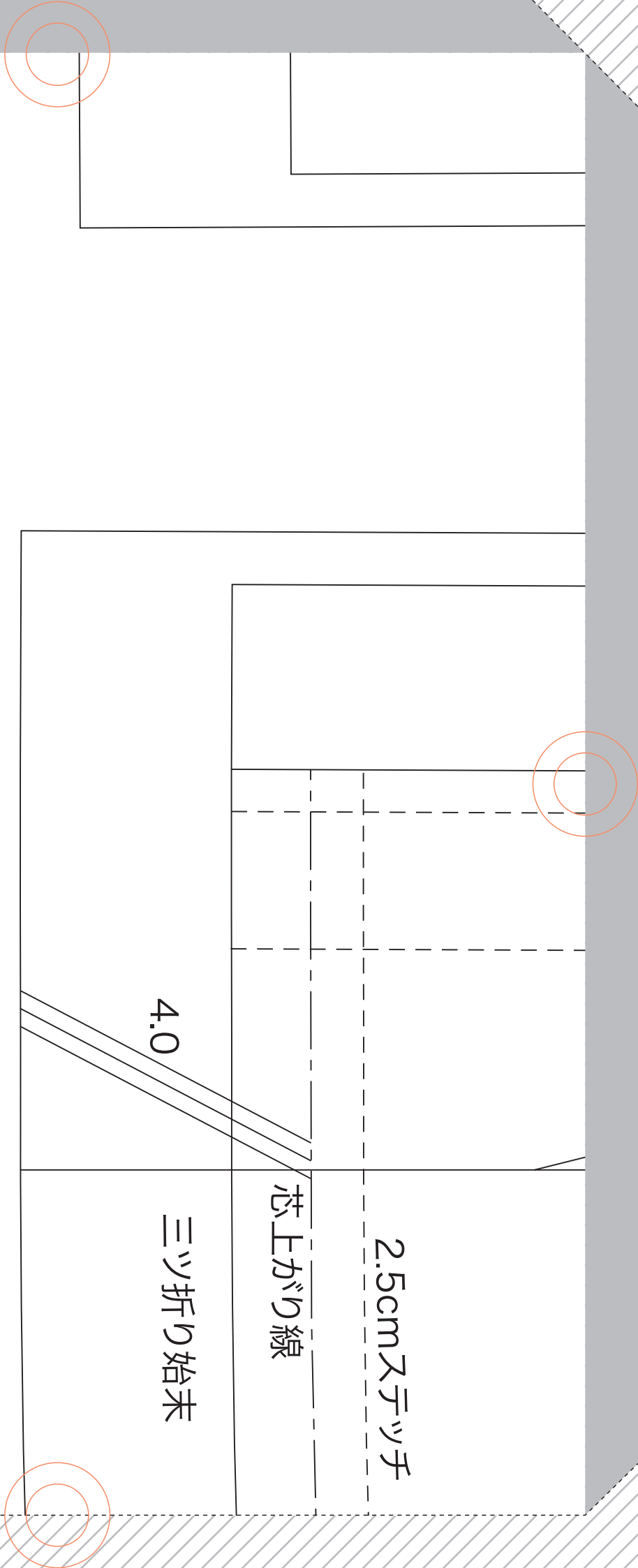

8

1.0

1.0

材

ベツ見返し押さえスツチ

9

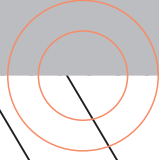

1.0

シタリ

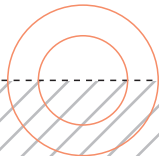
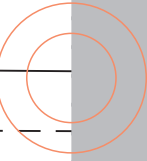
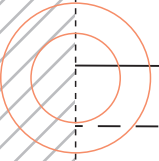

10

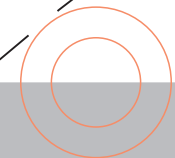
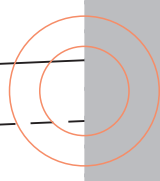
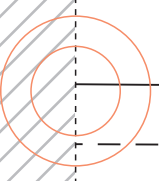
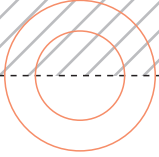

折り伏せ始末

裏地上がり線

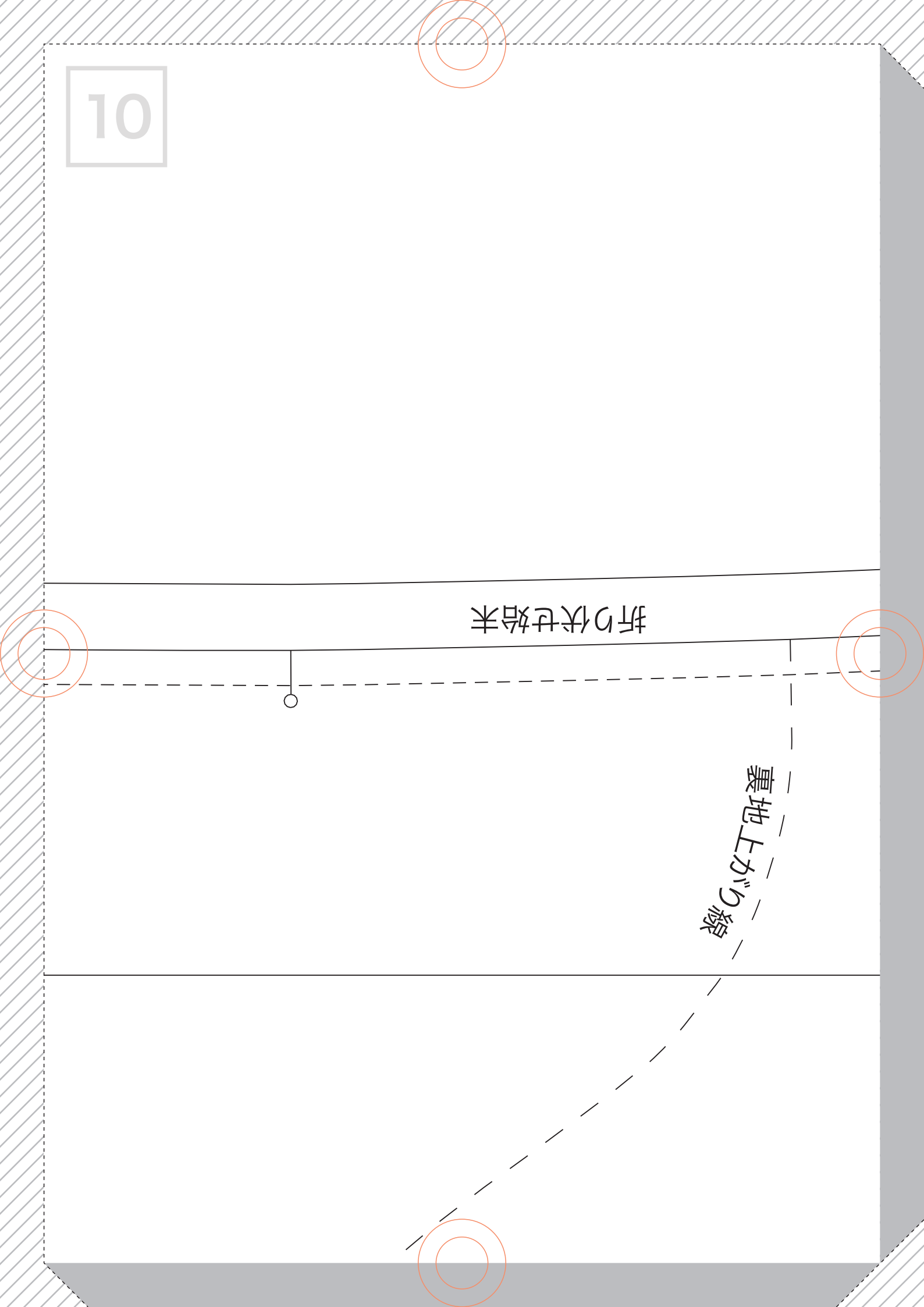

11

1.5

B・C

0.8cm入ツチ

fabfab-13

右後身頃

size : 11

表×1枚

12

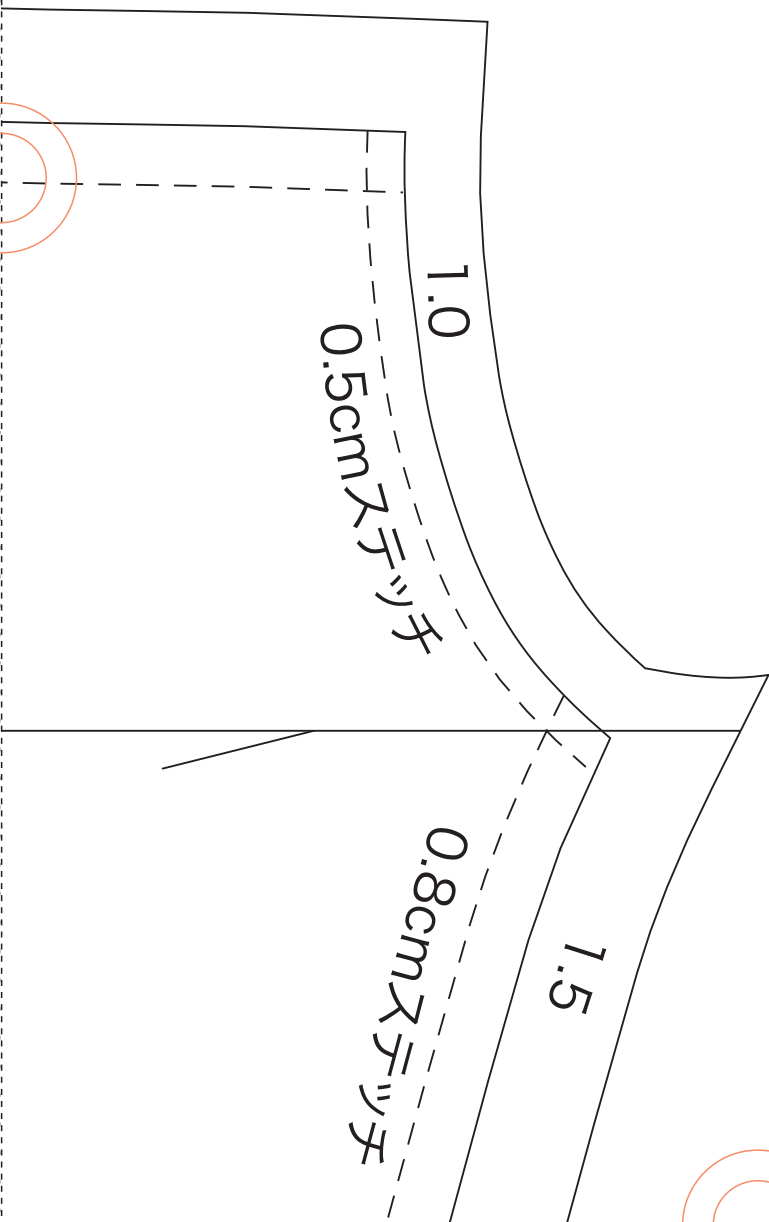

13

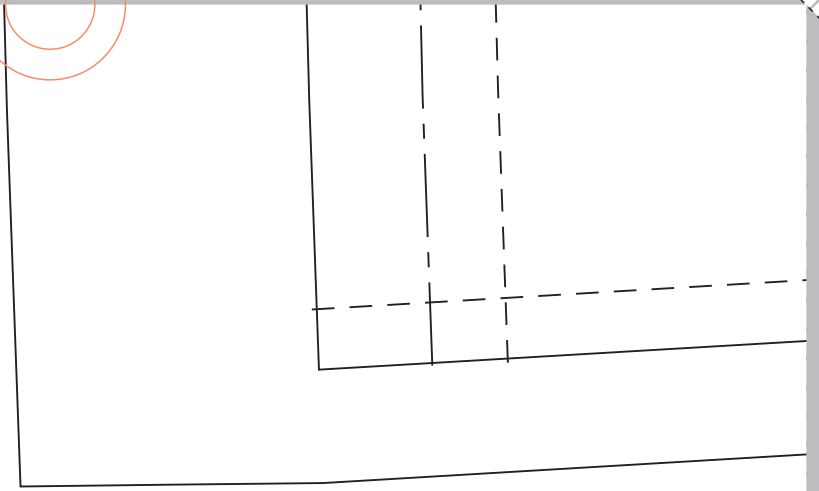
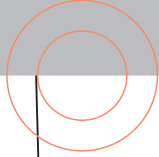

14

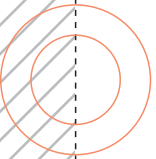
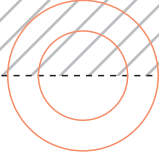

1.0

F.C

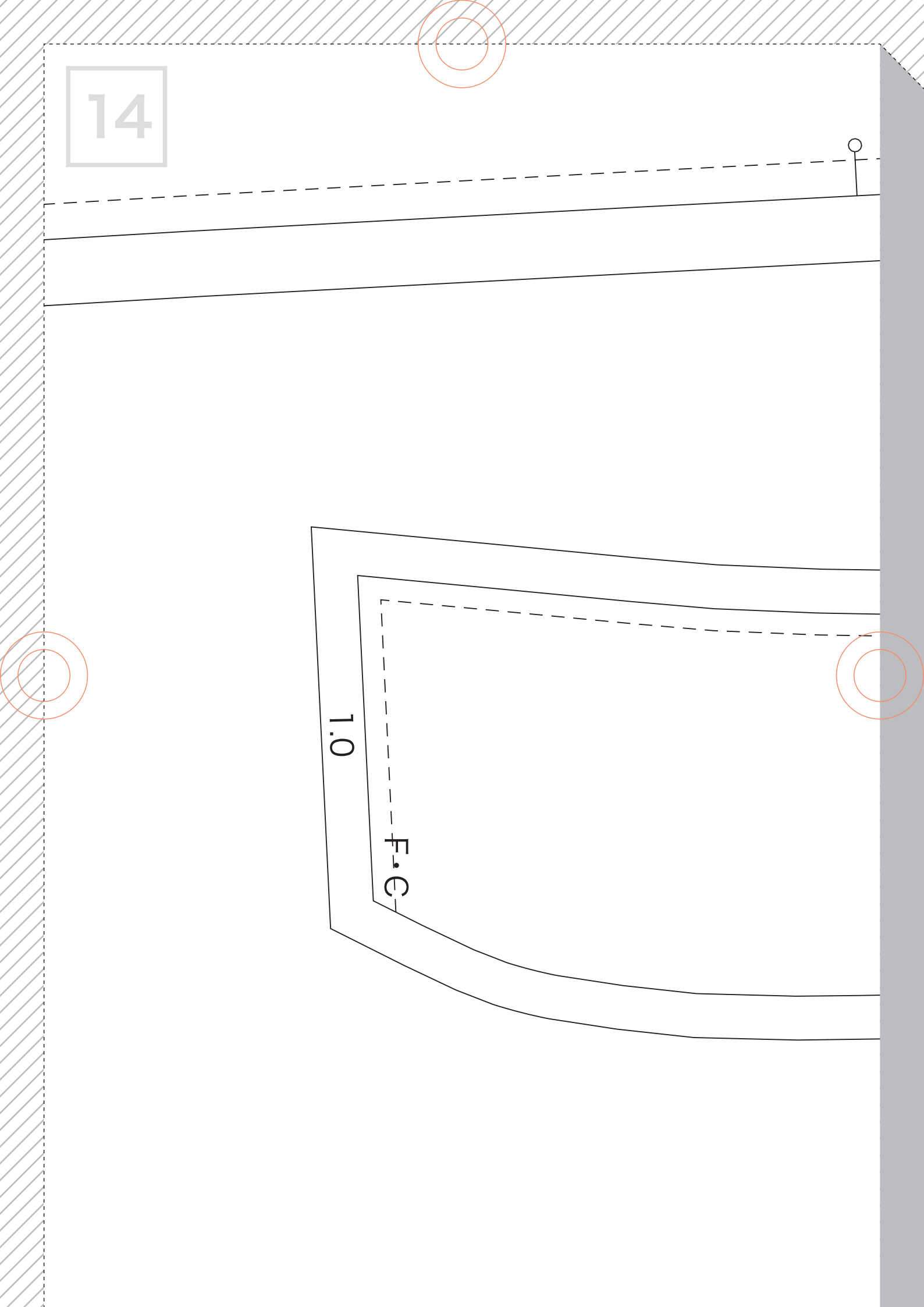

15

0.8cmステッチ

折り伏せ始末

0.5cmステッチ

N・P

B・C

N・

1.0

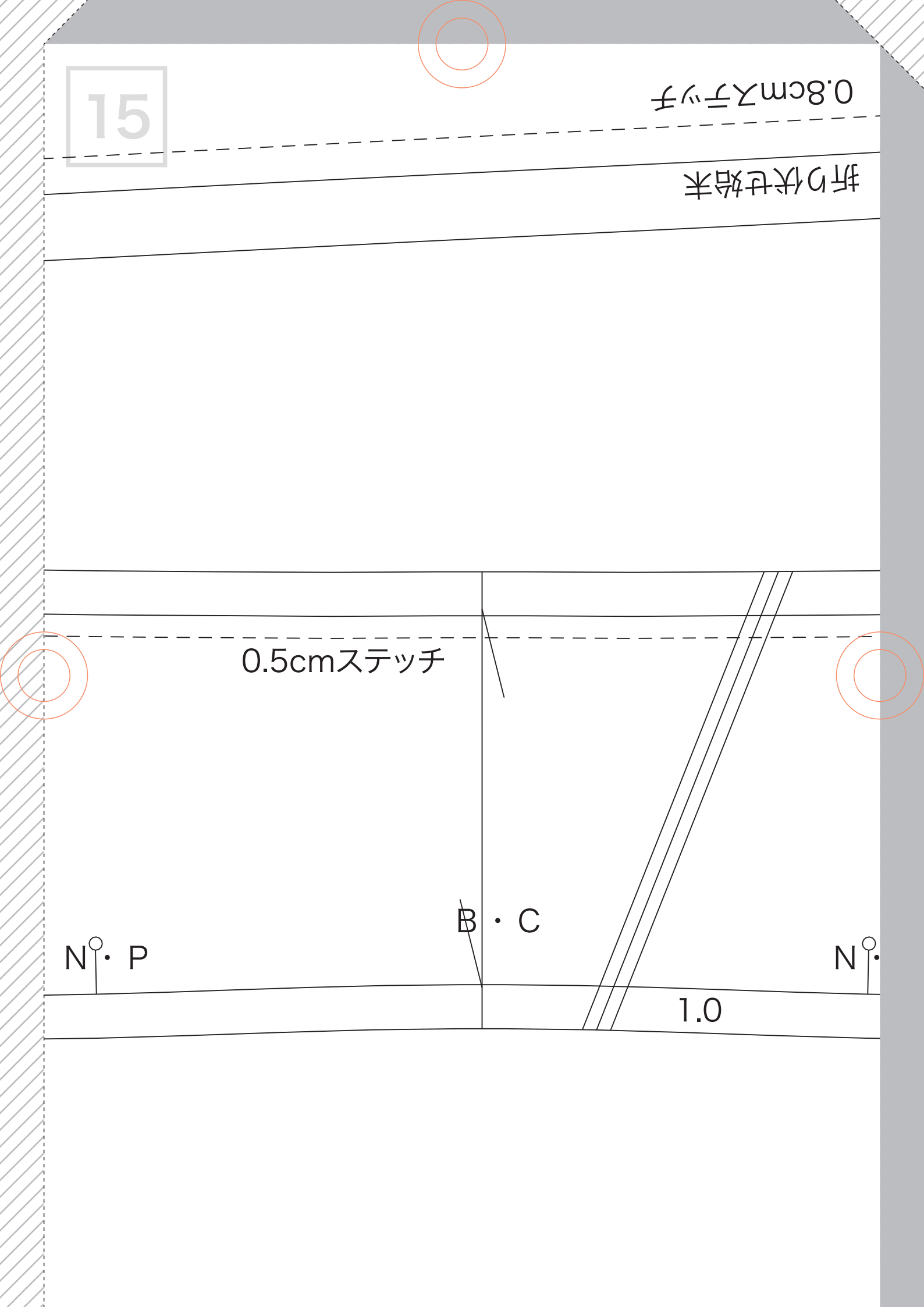

16

1.5

1.0

f a b f a b - 13

衿

size : 11

表 × 2 枚

芯 × 2 枚

F.C

1.0

P

17

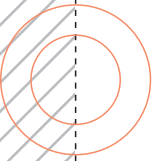
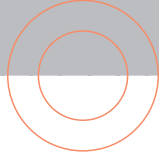
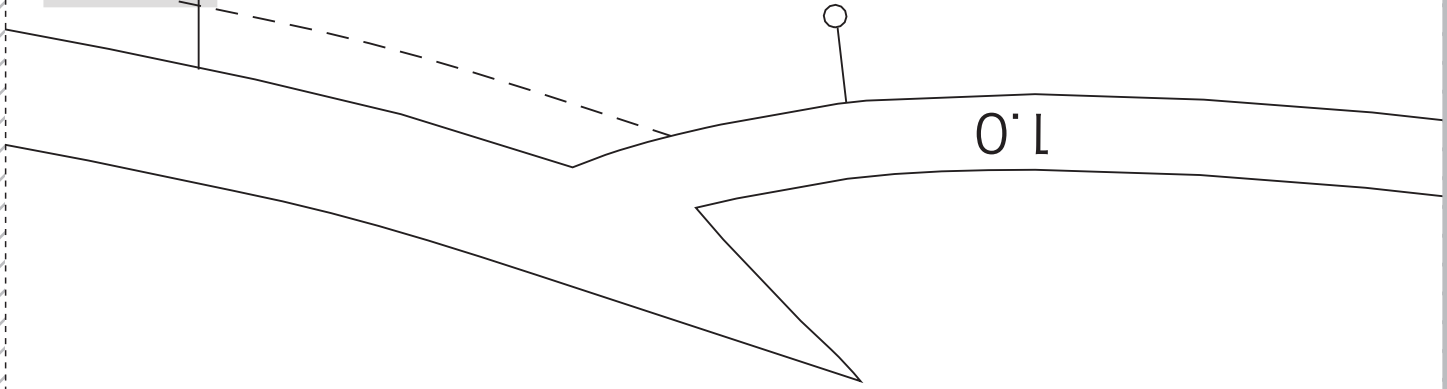

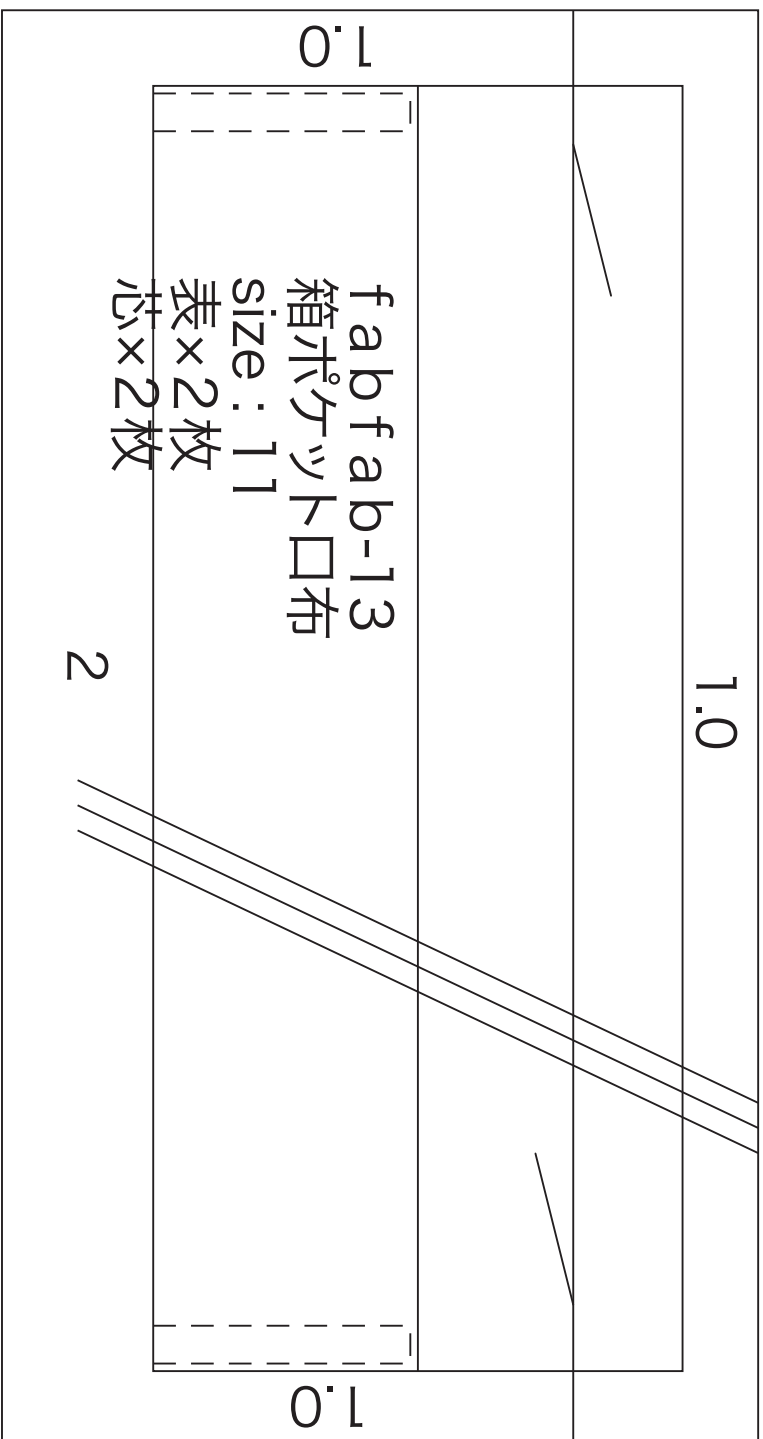

折り伏せ始末

18

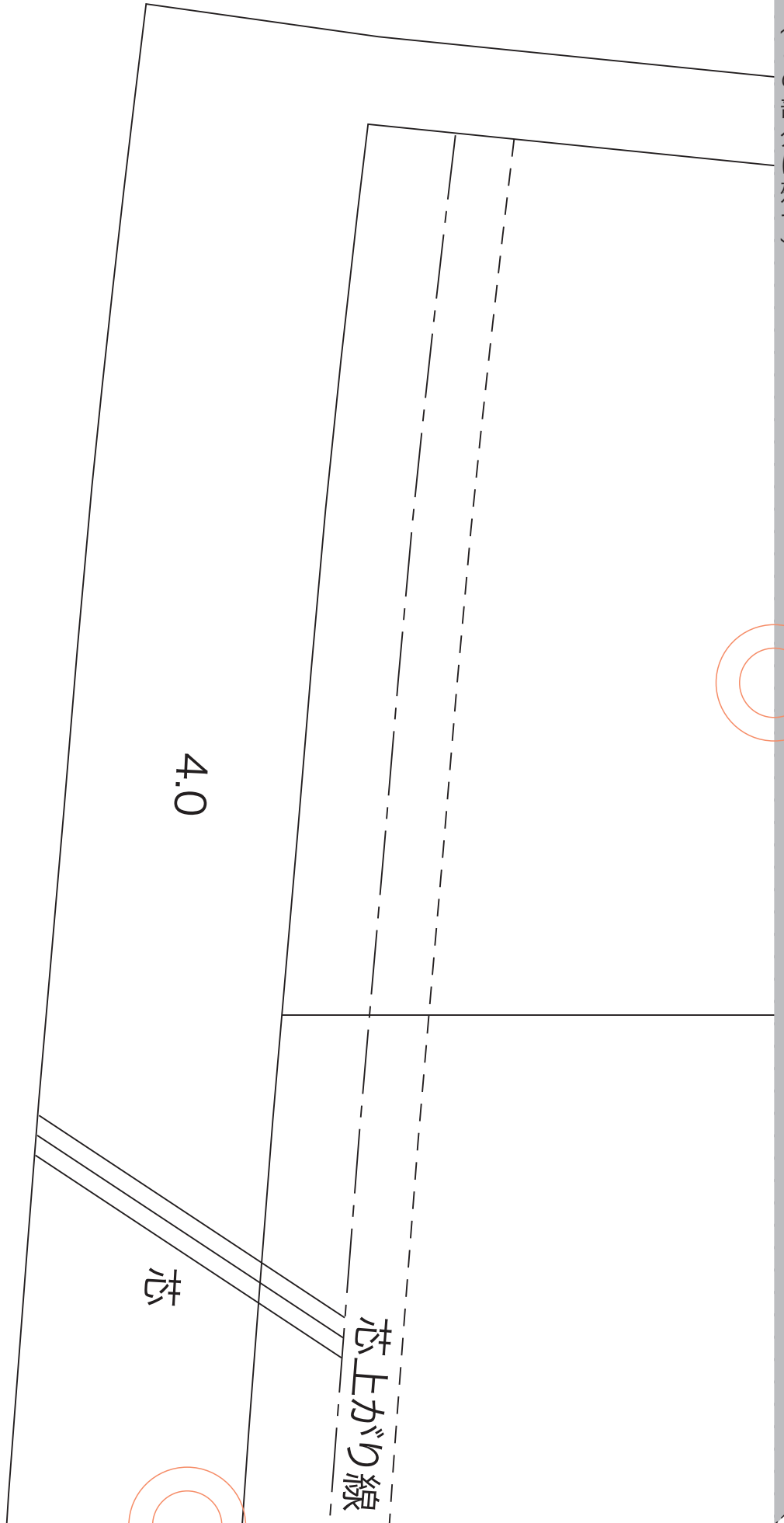

切り取る (斜線部はカット)

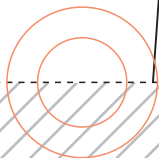

20

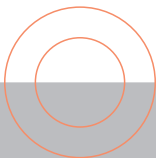
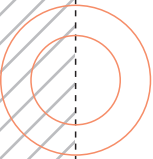
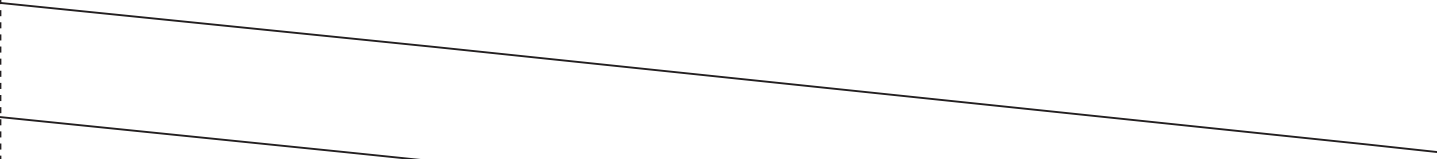

21

折り伏せ始末

裏地上がり線

切り込み位置

箱ポケット

口布のまわり芯貼る

芯

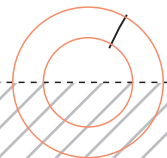
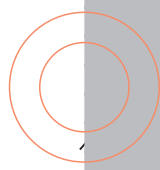
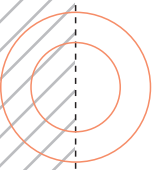

22

1.5

f a b f a b - 1 3

前身頃

size : 1 1

表×2枚

23

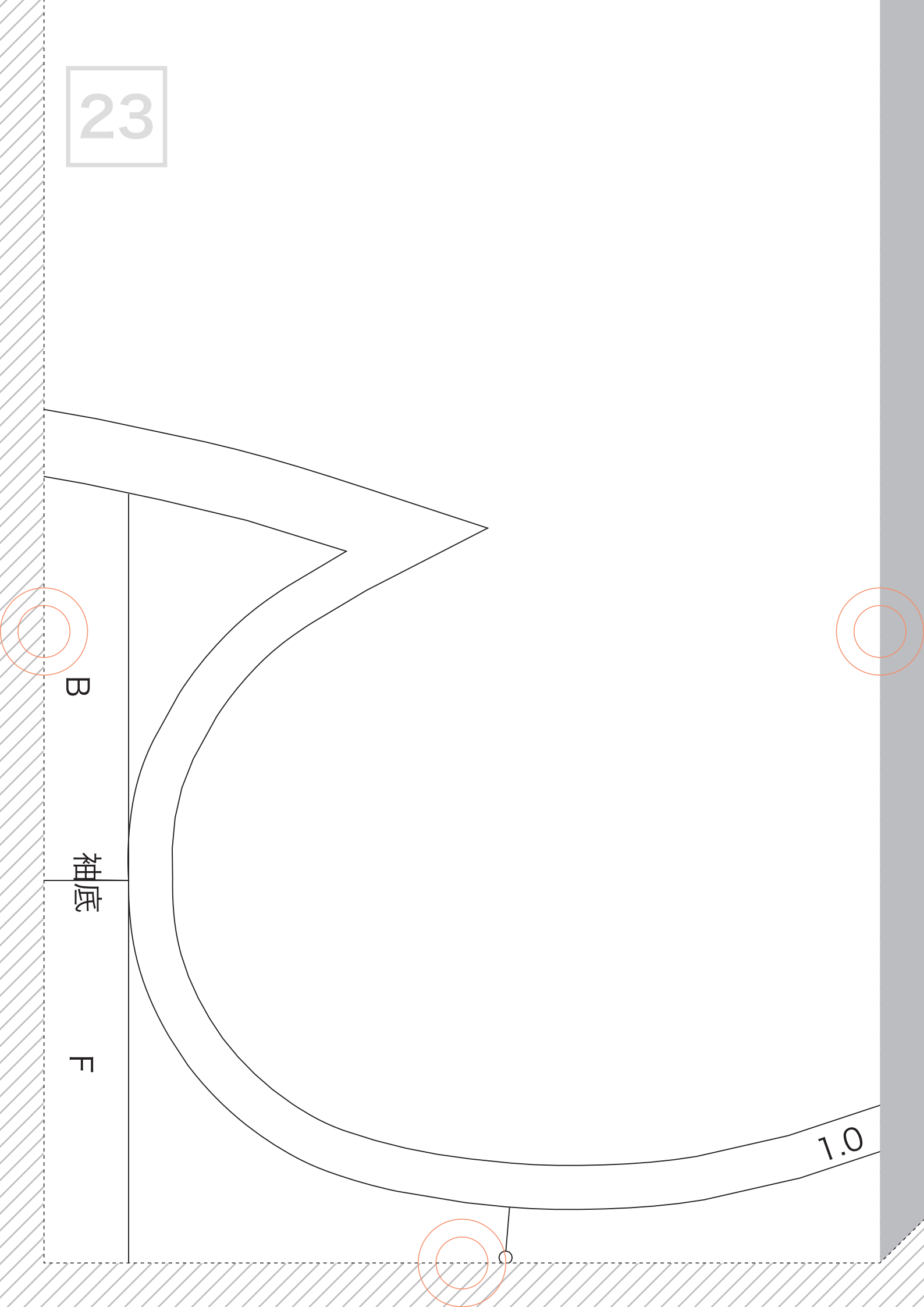

24

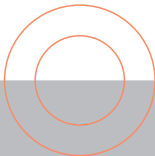
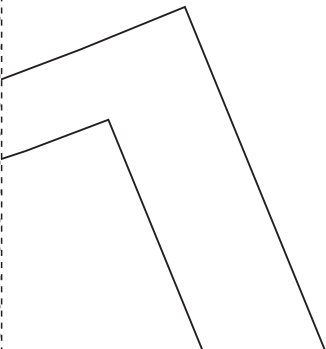
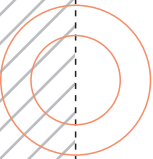

25

ミツ折り始末

2.5cmステッチ

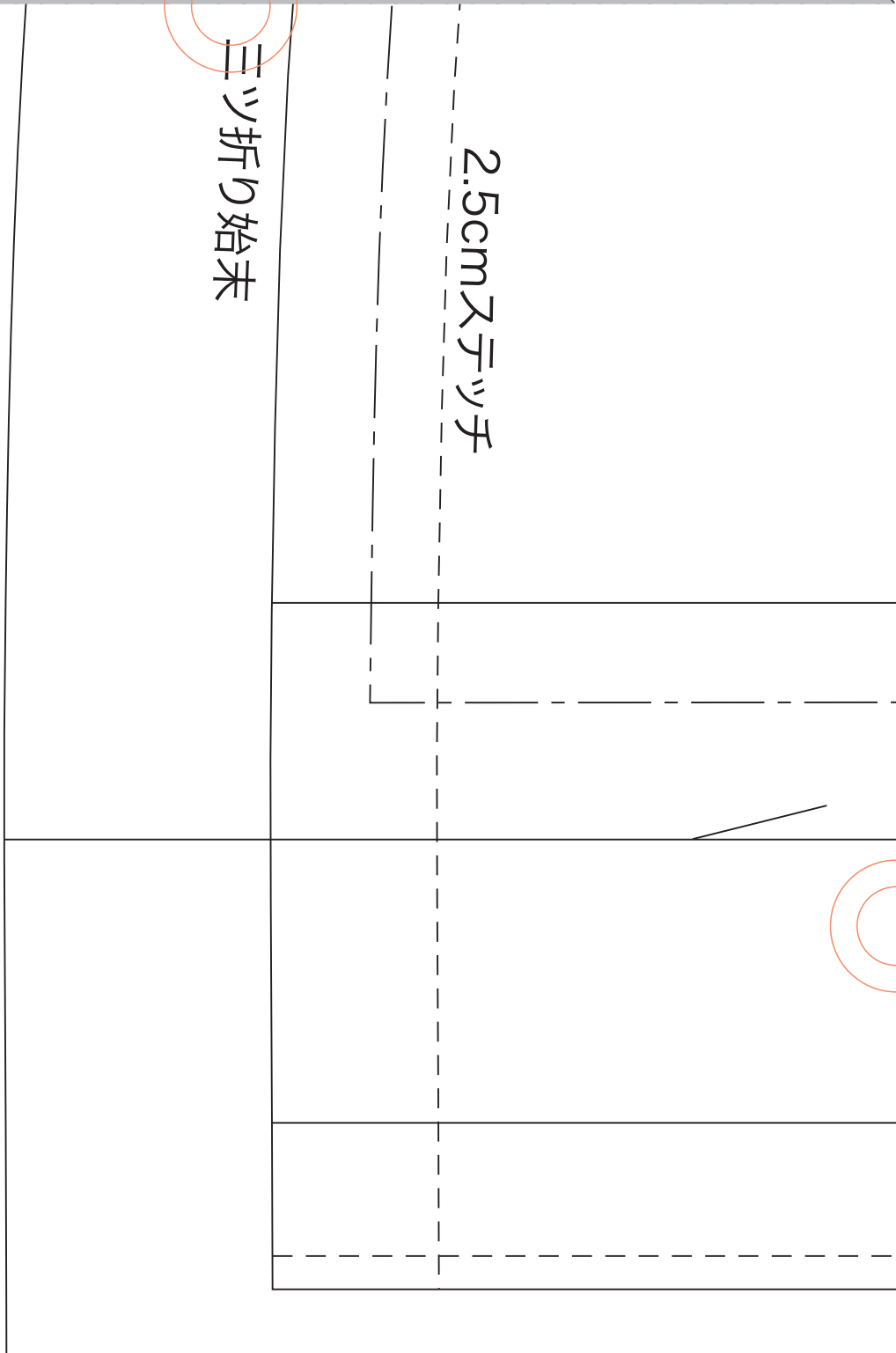

26

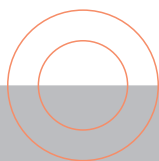
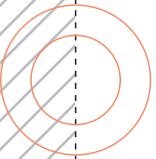
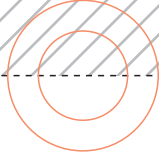

27

見返し線

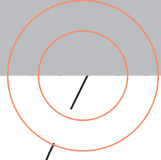
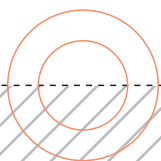
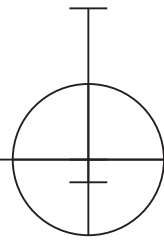
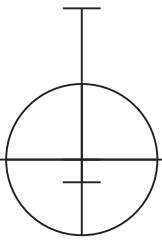

28

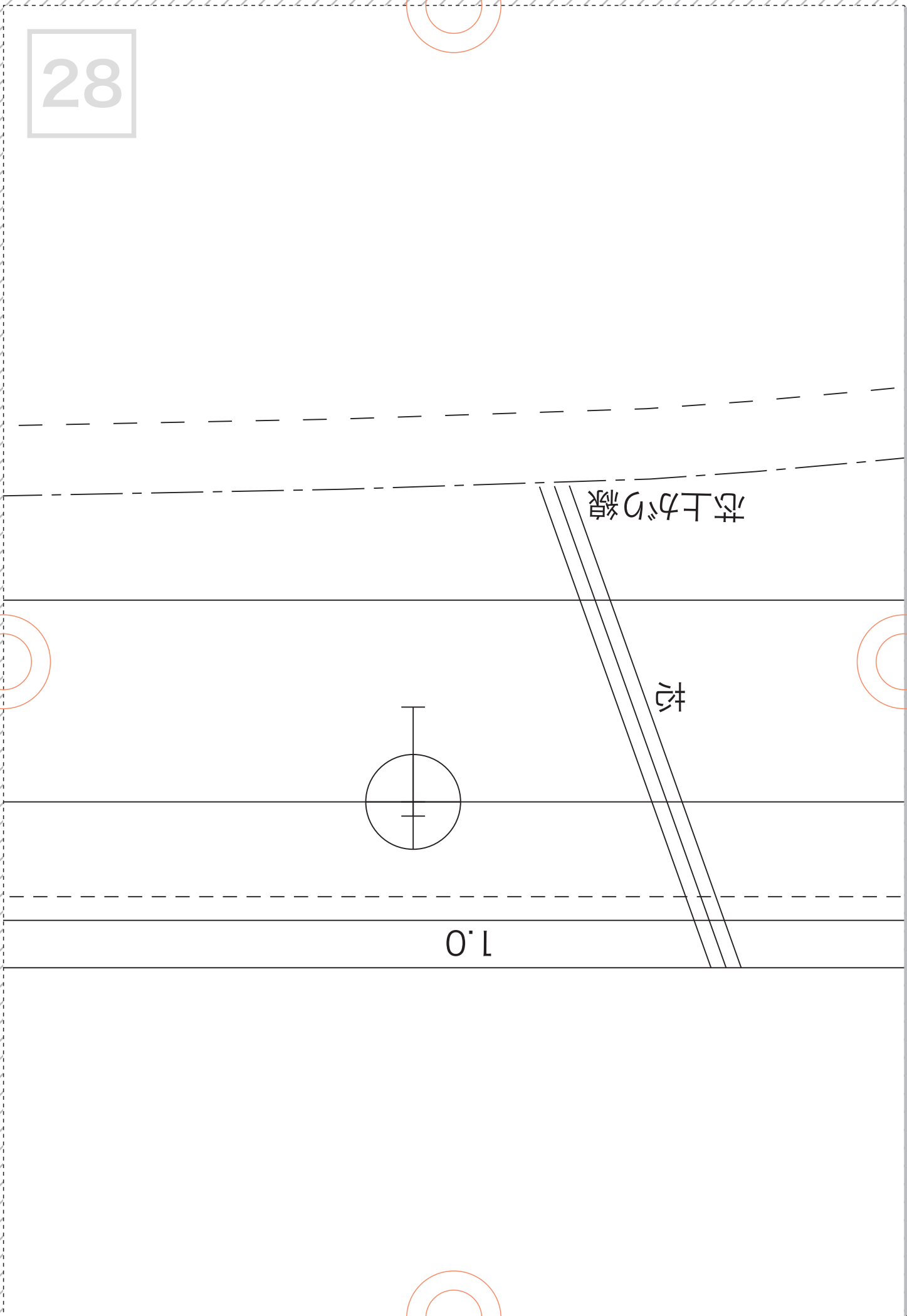

芯上がり線

杉

1.0

29

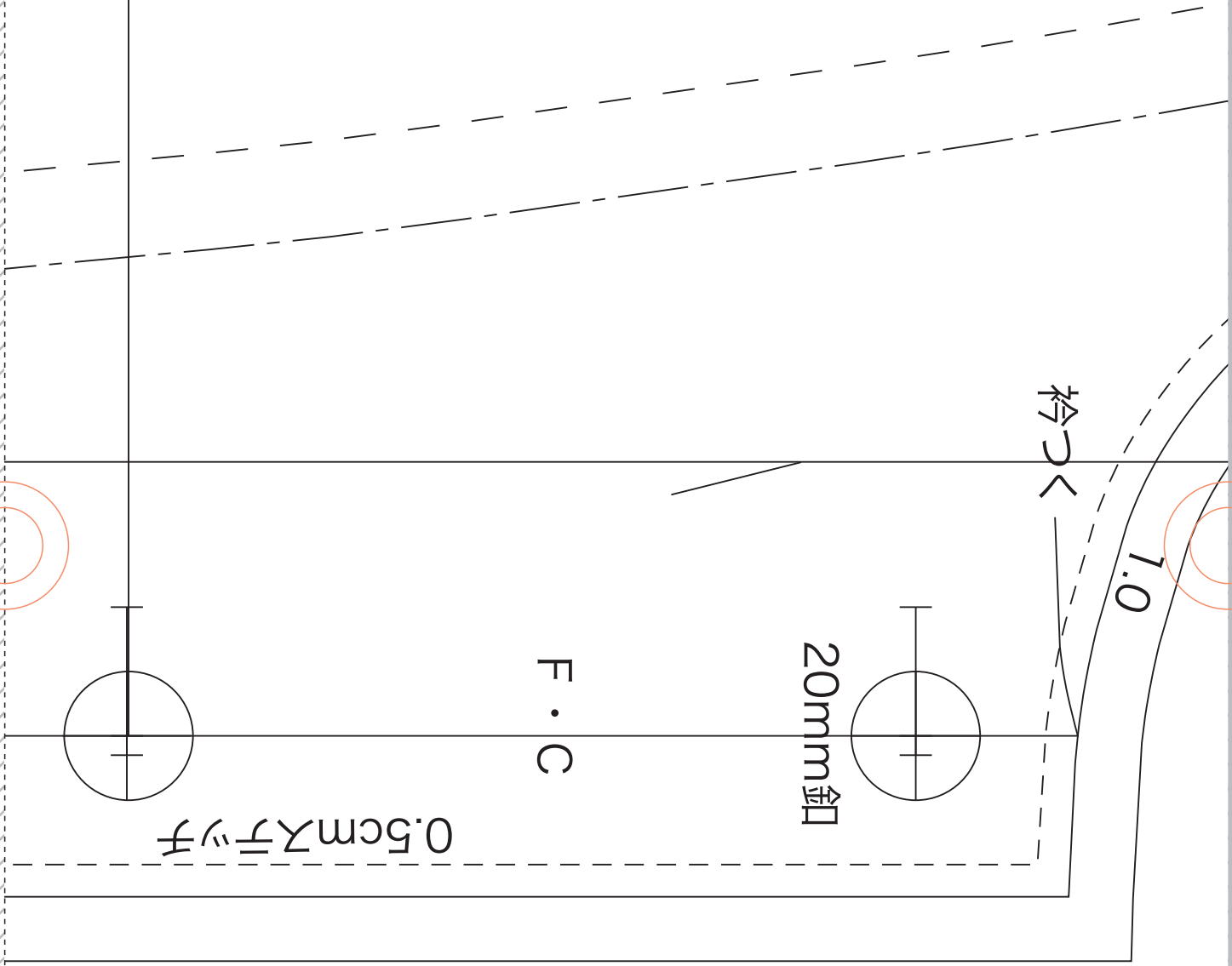

衿づく

1.0

20mm 釦

F・C

0.5cm ステッチ

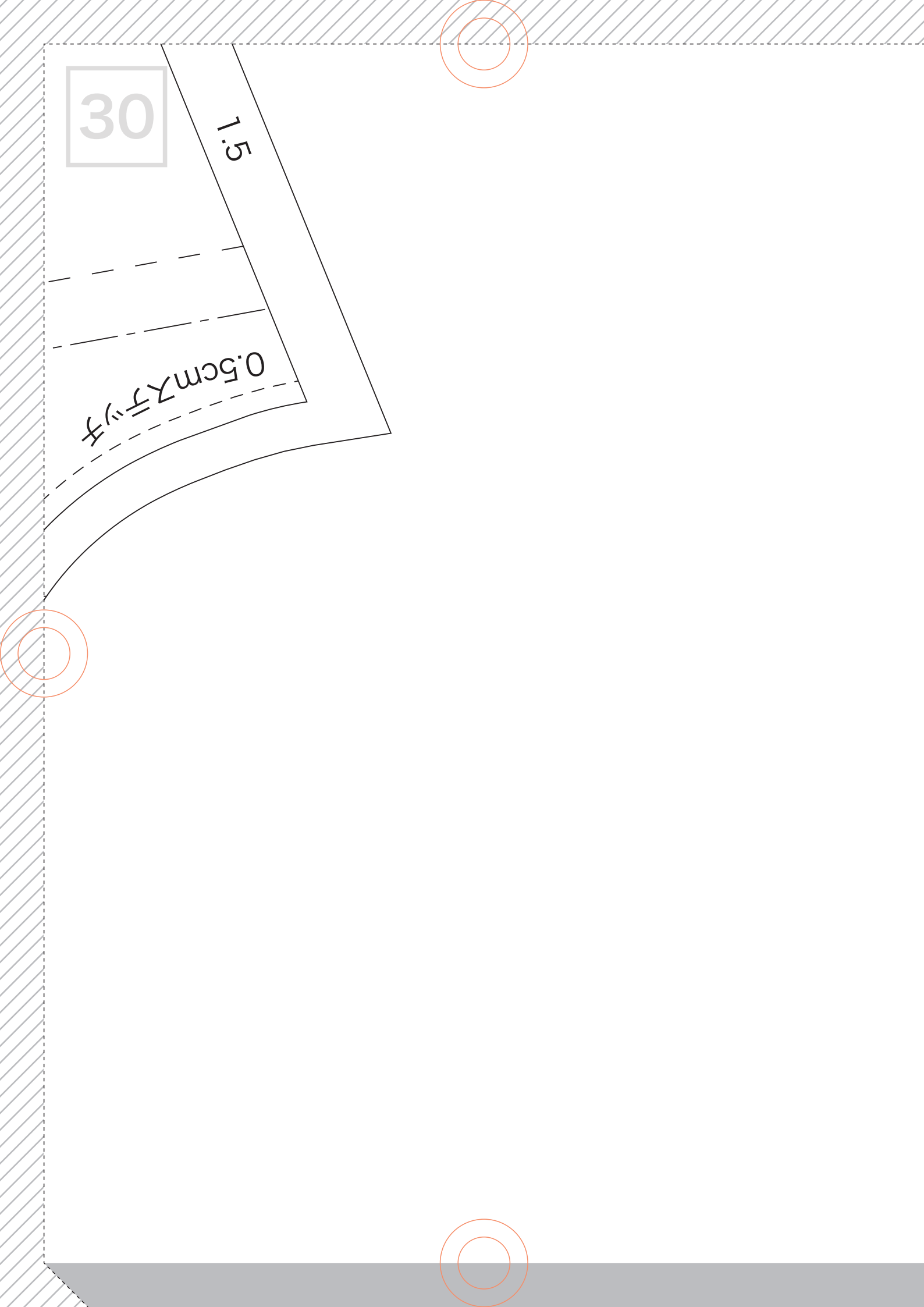

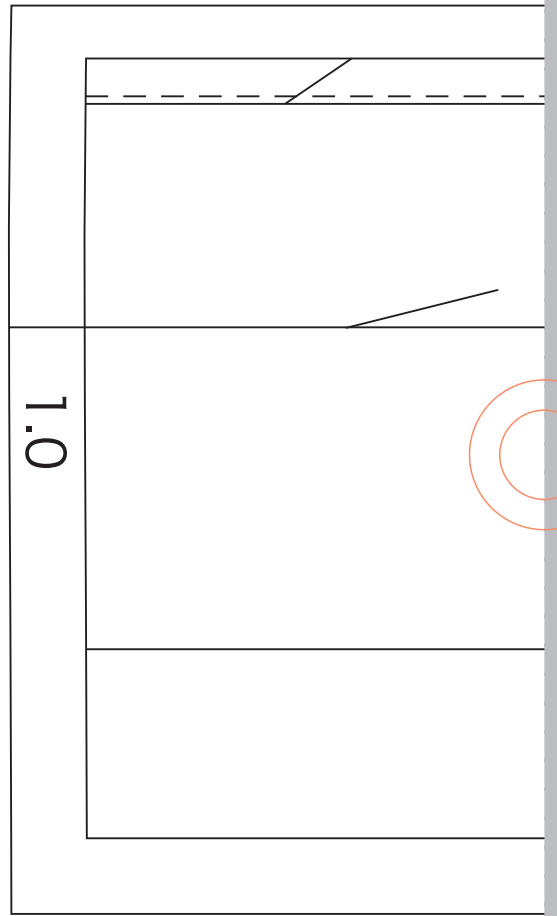
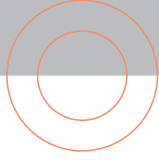

32

6mmバリエーションスタート

33

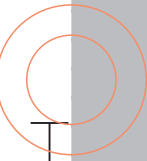
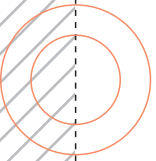
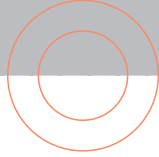

34

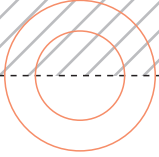

0.7

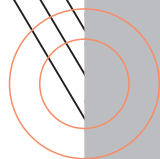
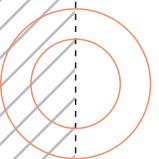

0.1

35

fabfab-13
前見返し
size : 11
表×2枚
芯×2枚

F・C

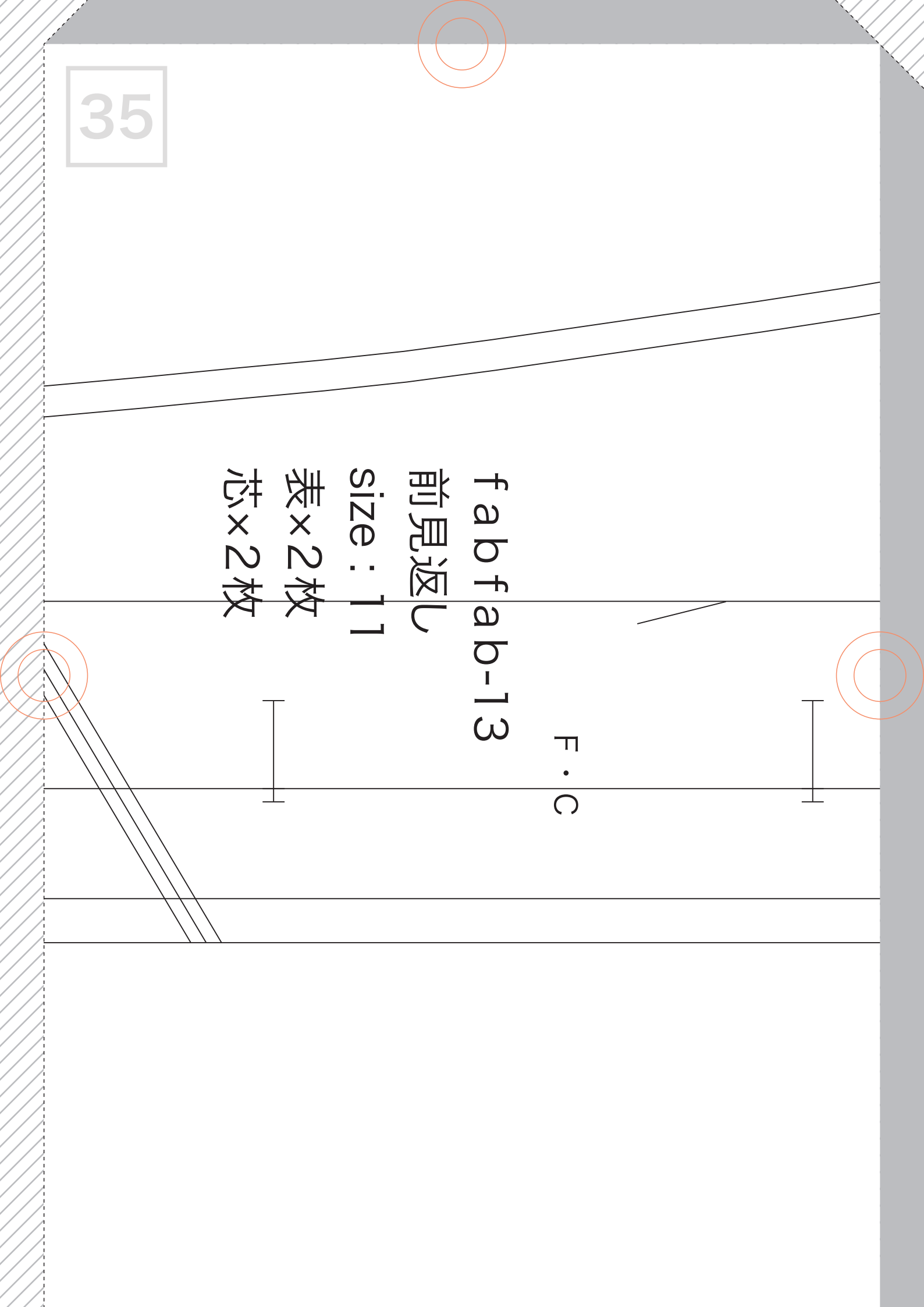

36

1.0

1.0

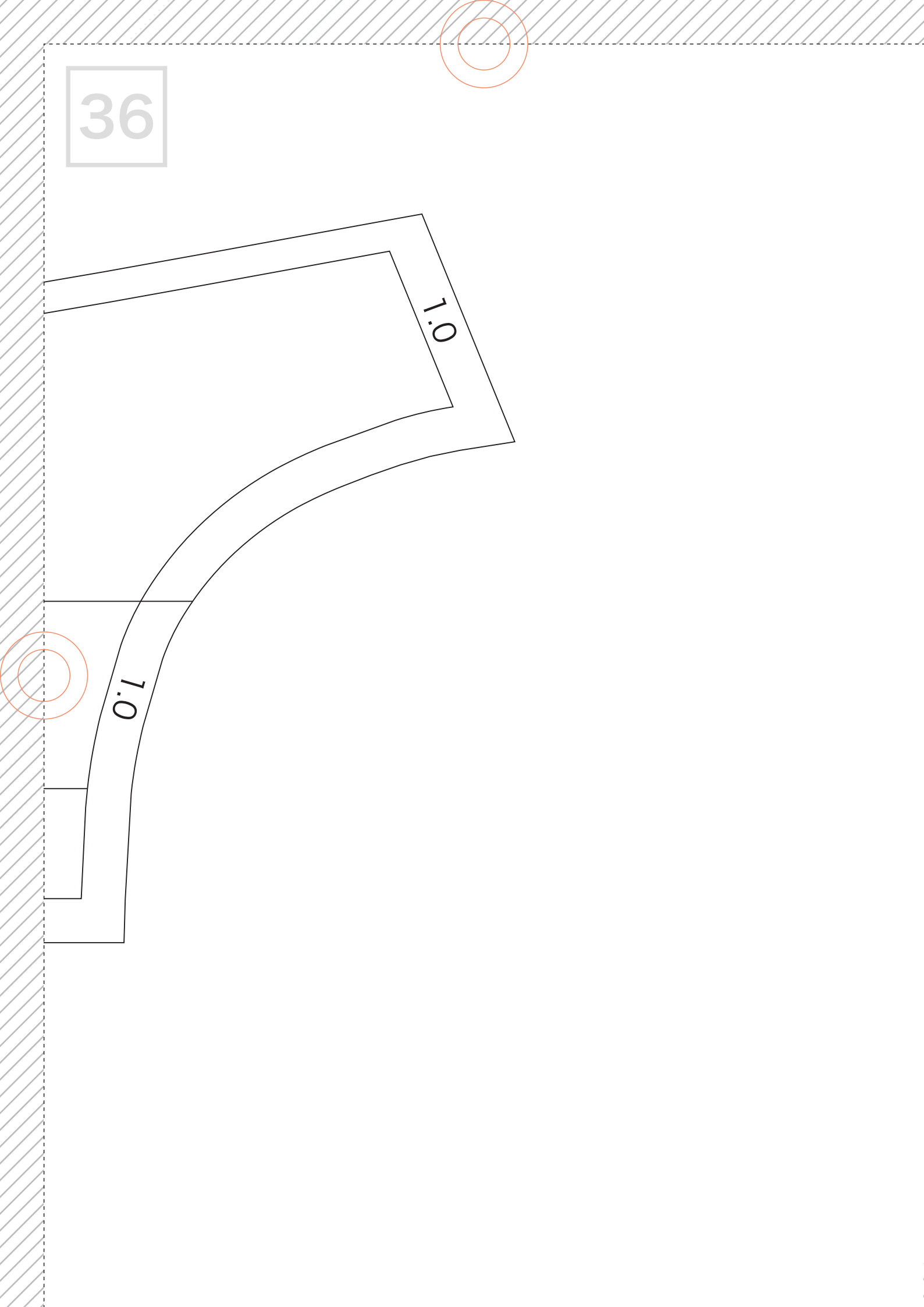

37

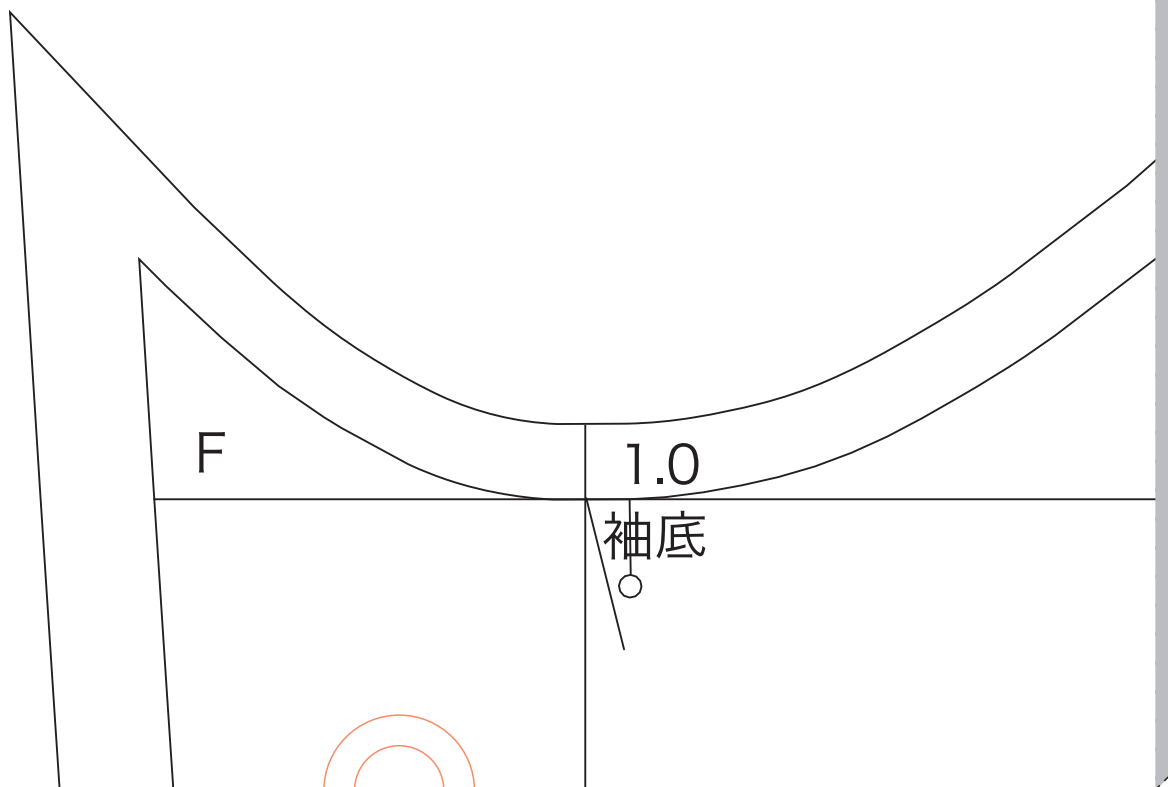

切り取る (斜線部はカット)

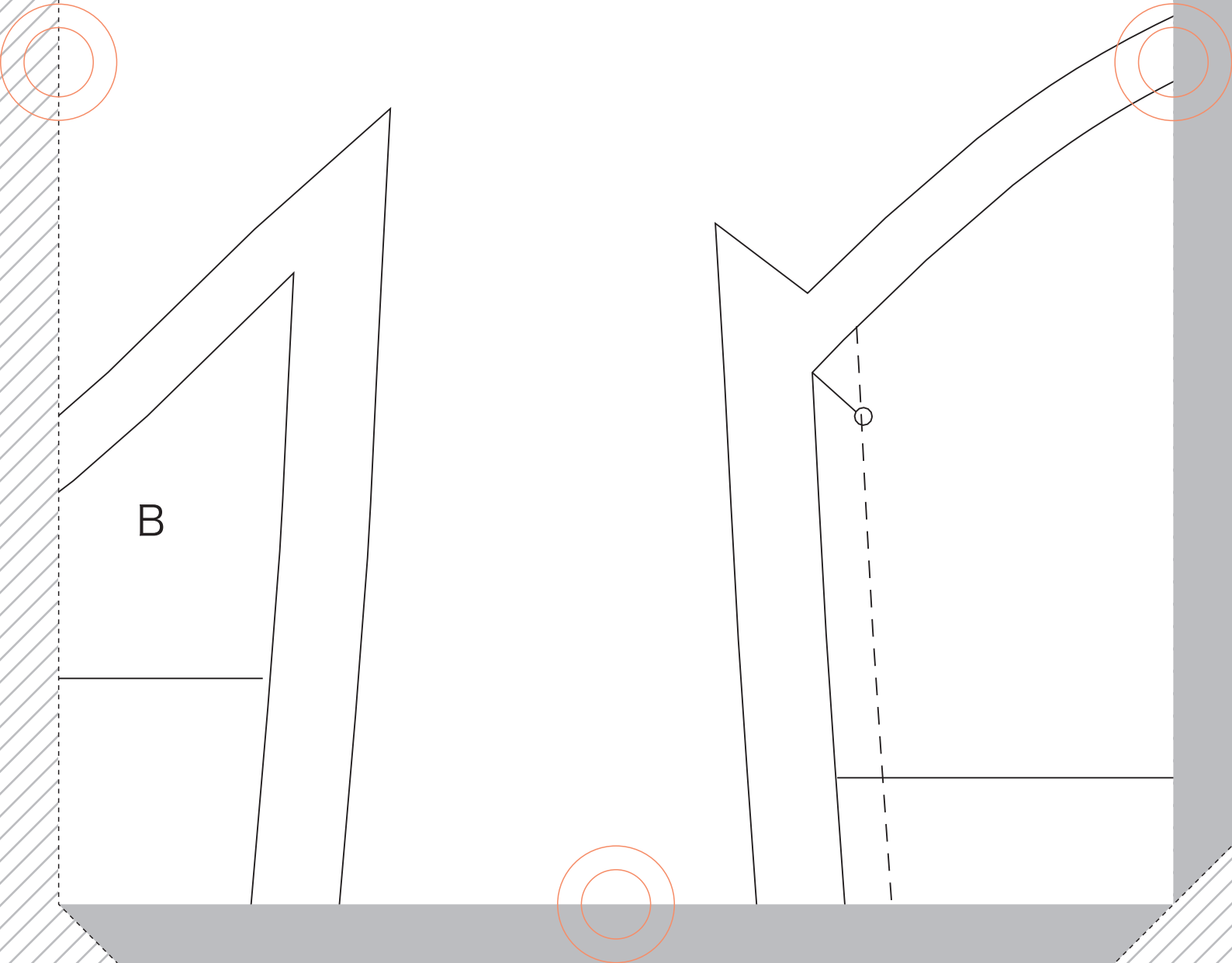

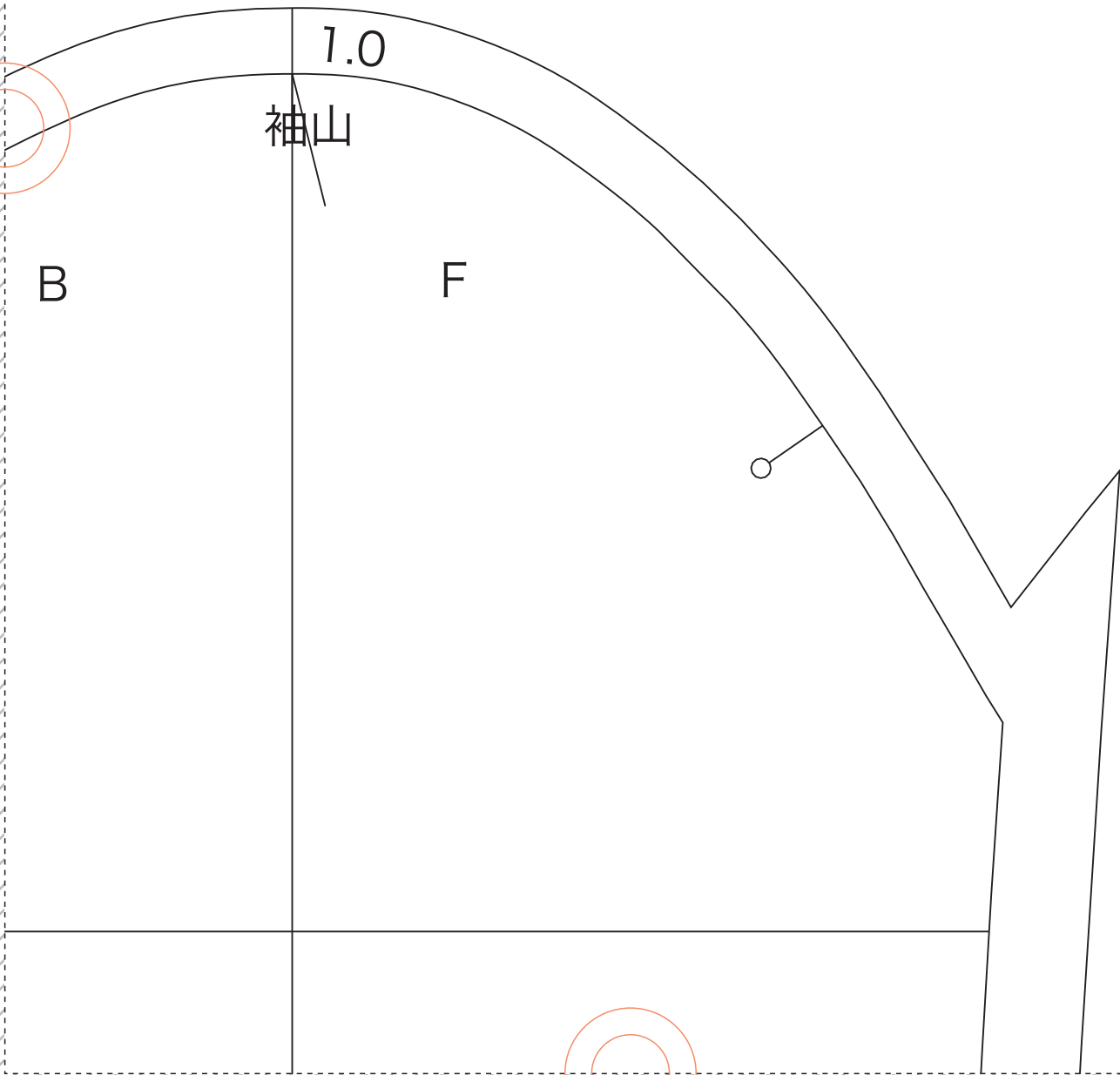

40

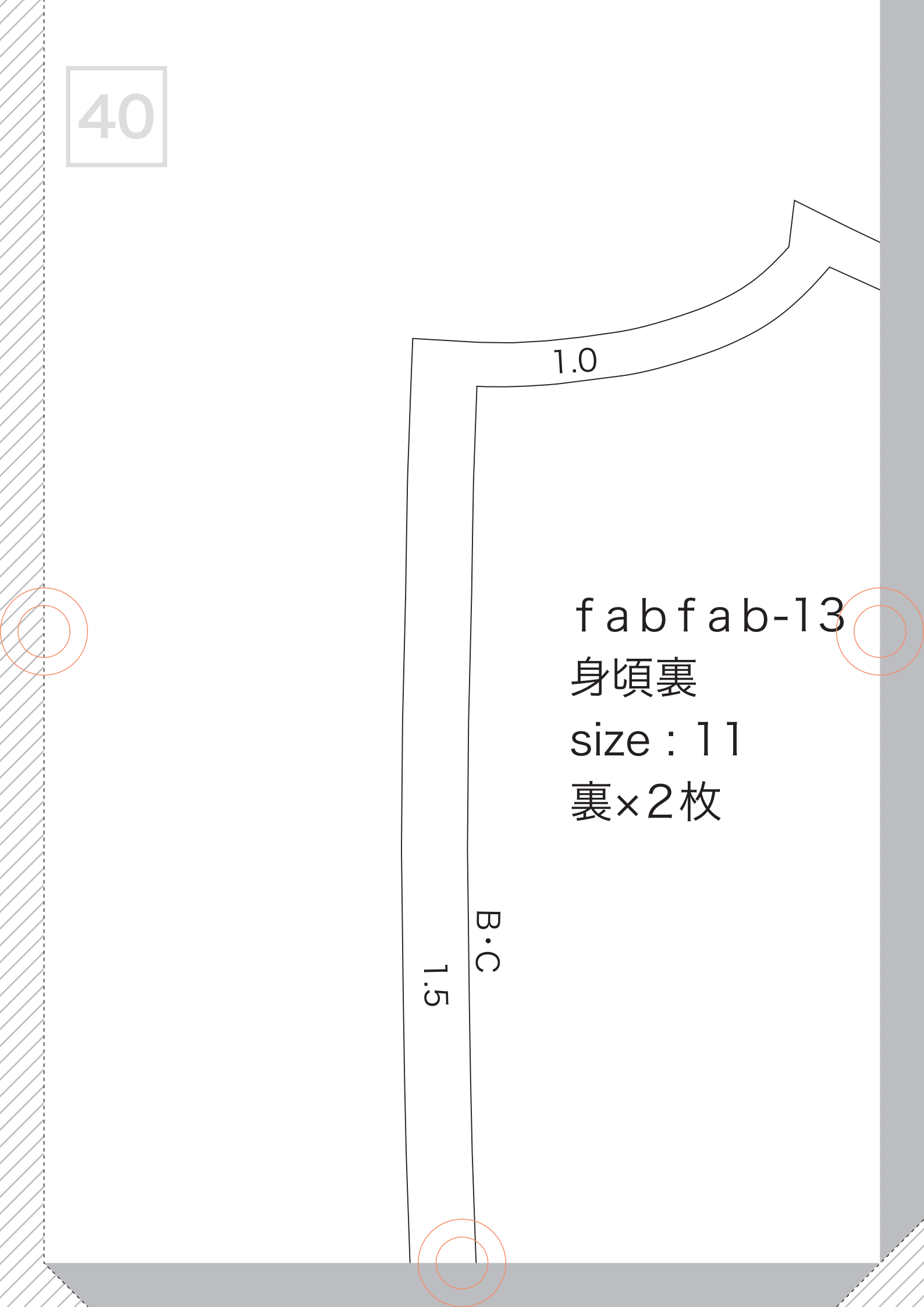

1.0

fabfab-13

身頃裏

size : 11

裏×2枚

1.5

B.C

41

1.0

1.0

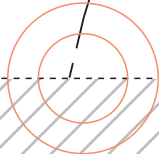
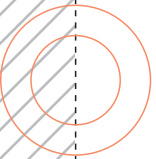

42

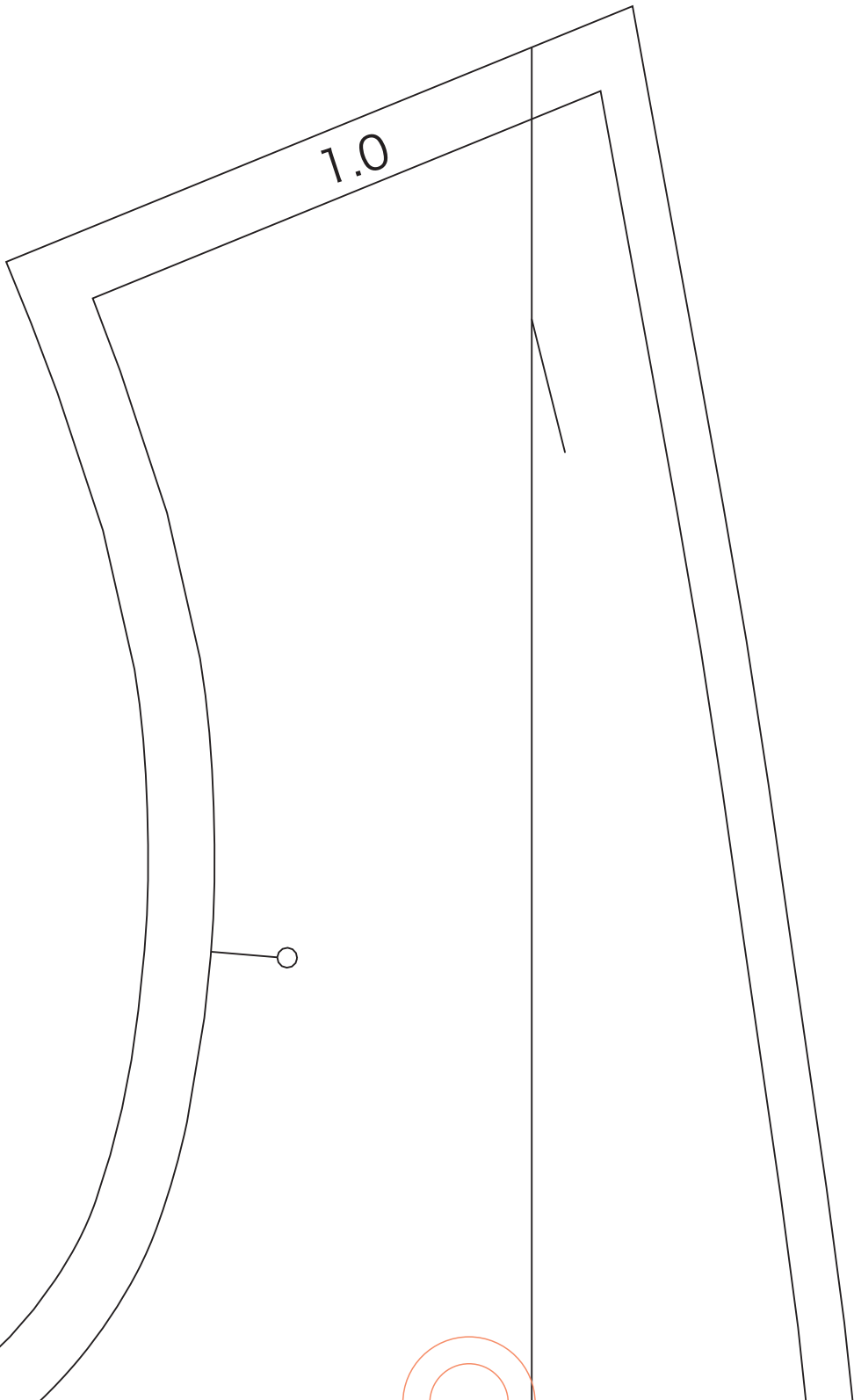

43

6mmバイヤステープレ始末 割り

1.5

f a b f a b-13

内袖

size : 11

表×2枚

44

1.5
折り伏せ始末

1.5
折り伏せ始末

0.8cmステッチ

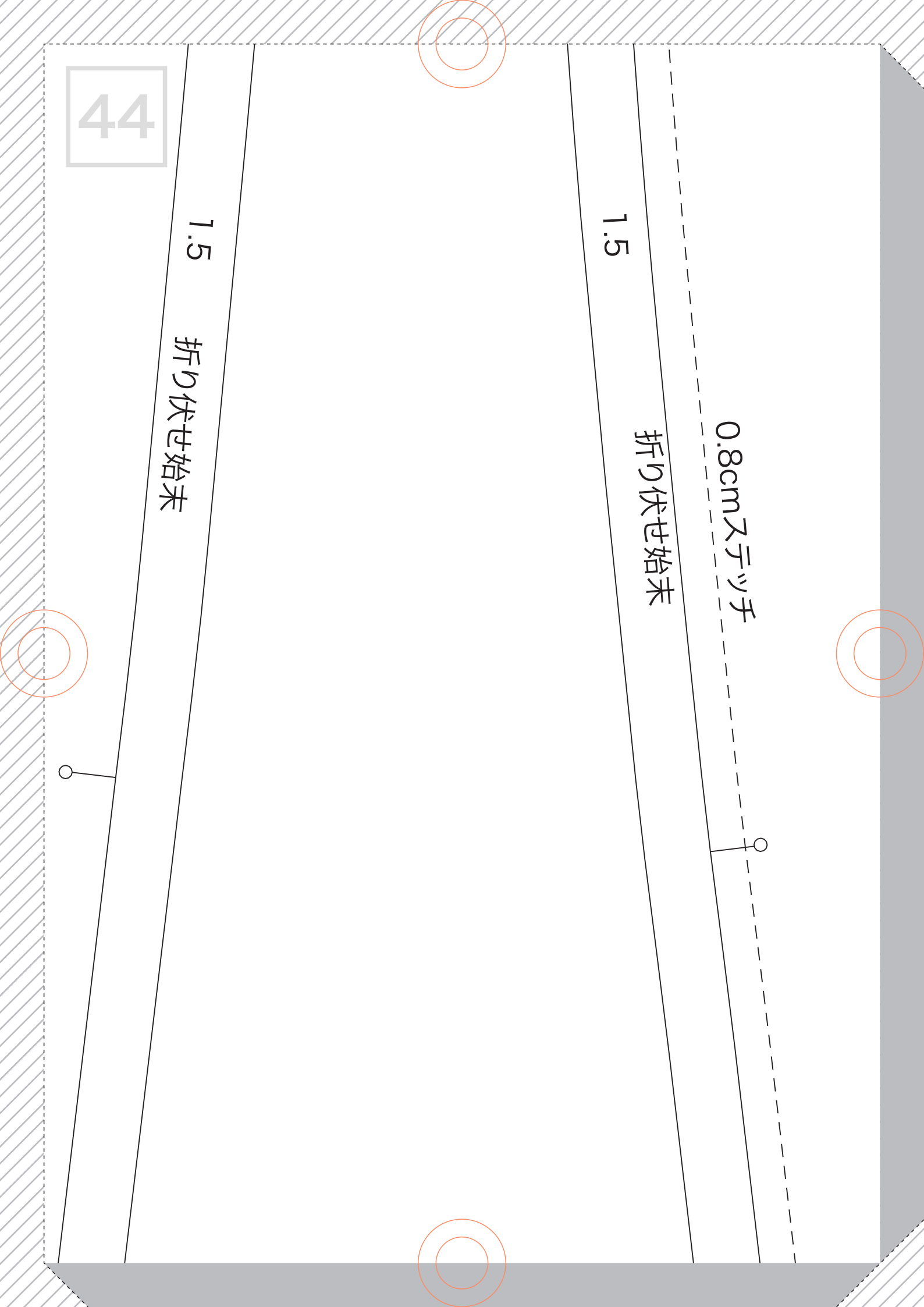

45

f a b f a b-13

外袖

size : 11

表×2枚

6mmバイヤステーファ始末 割り

1.5

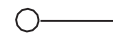

46

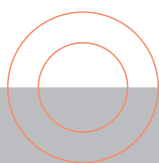
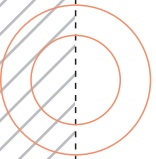
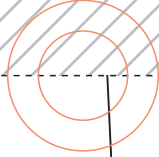

0

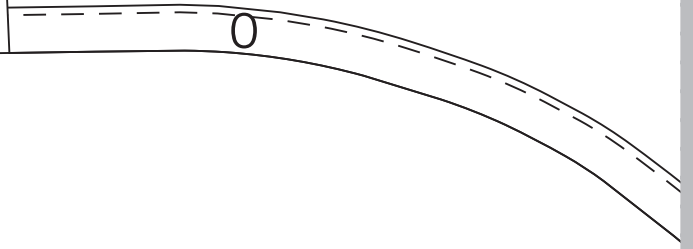

47

B

袖底

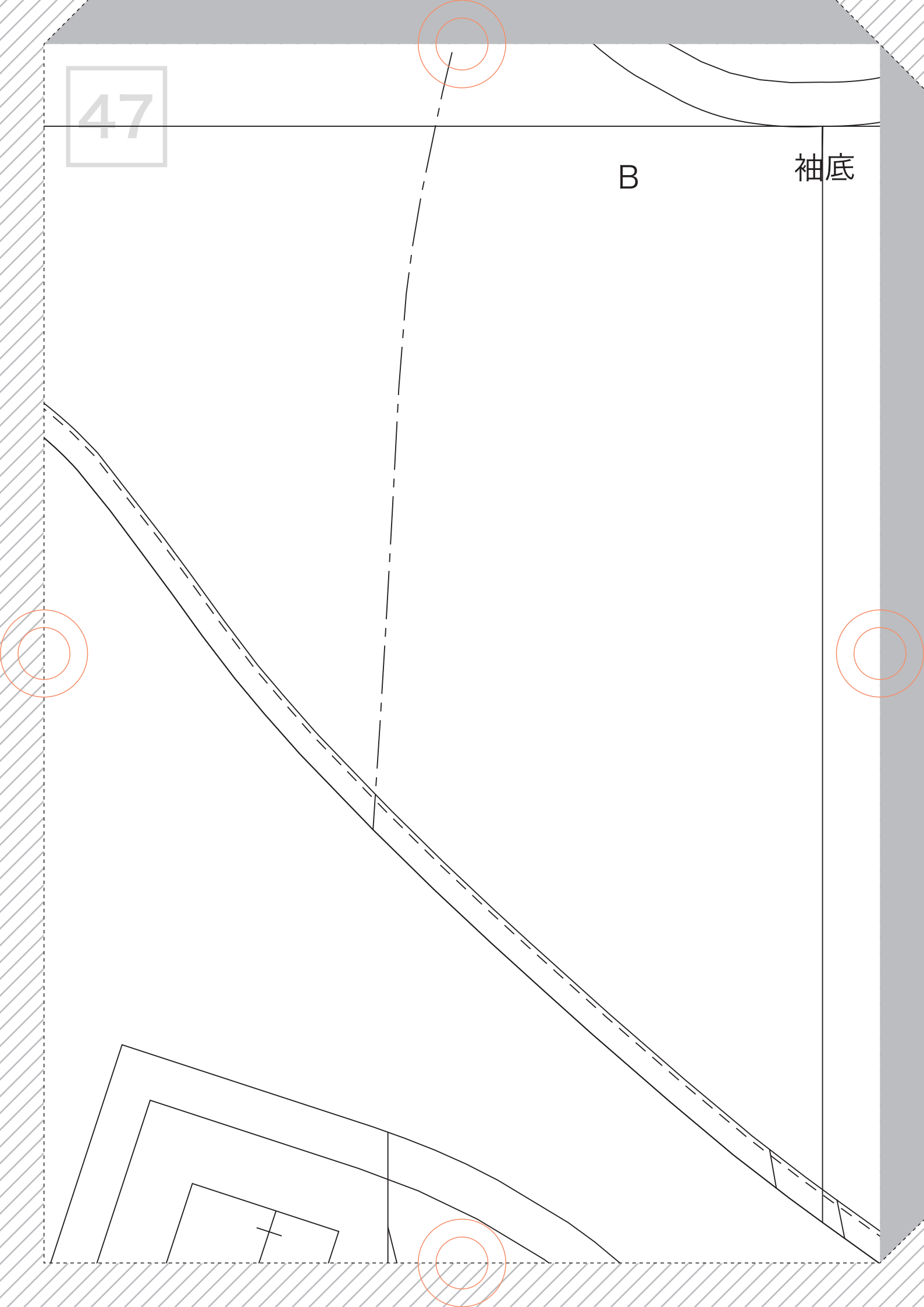

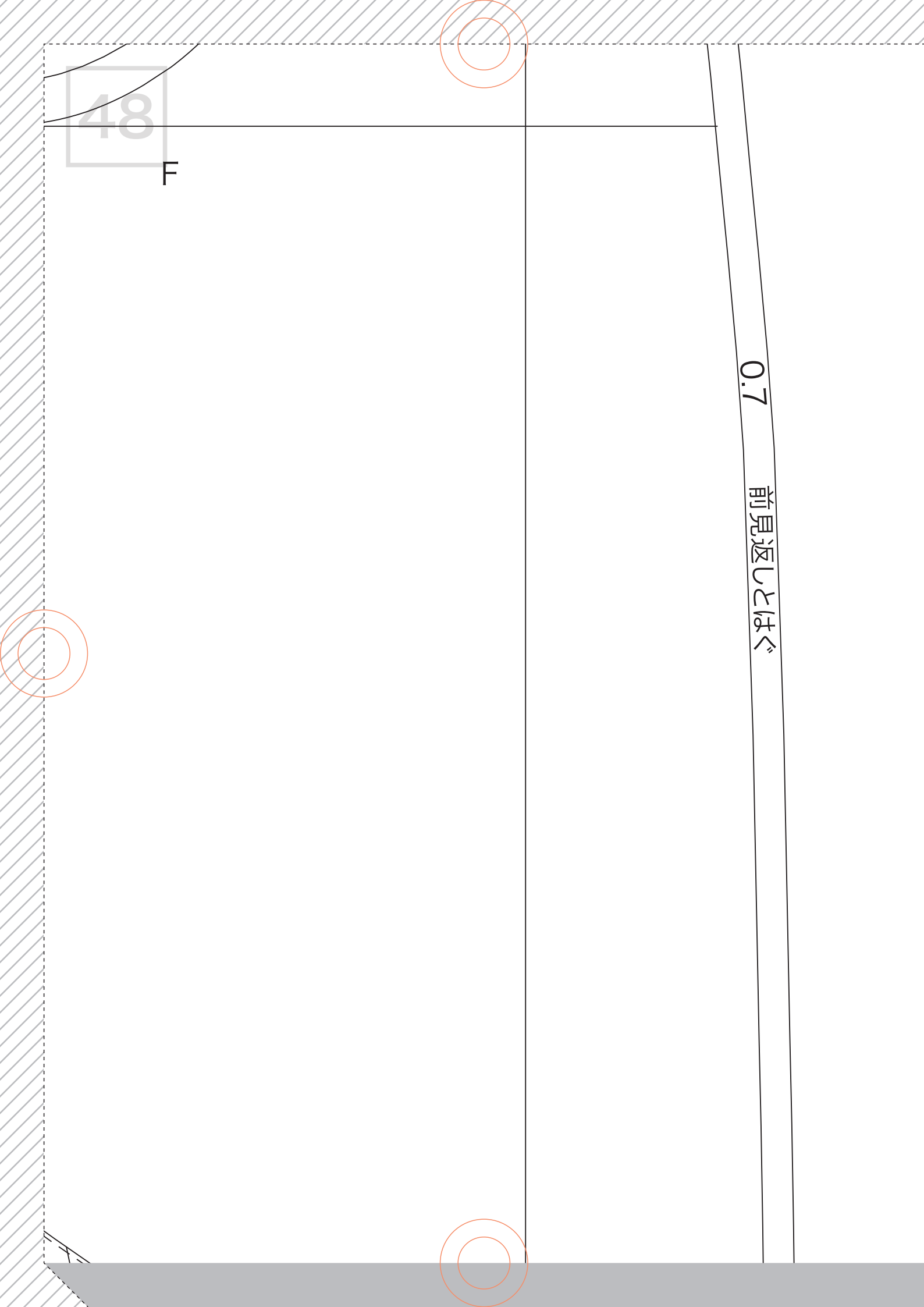

48

F

0.7
前見返しとはぐ

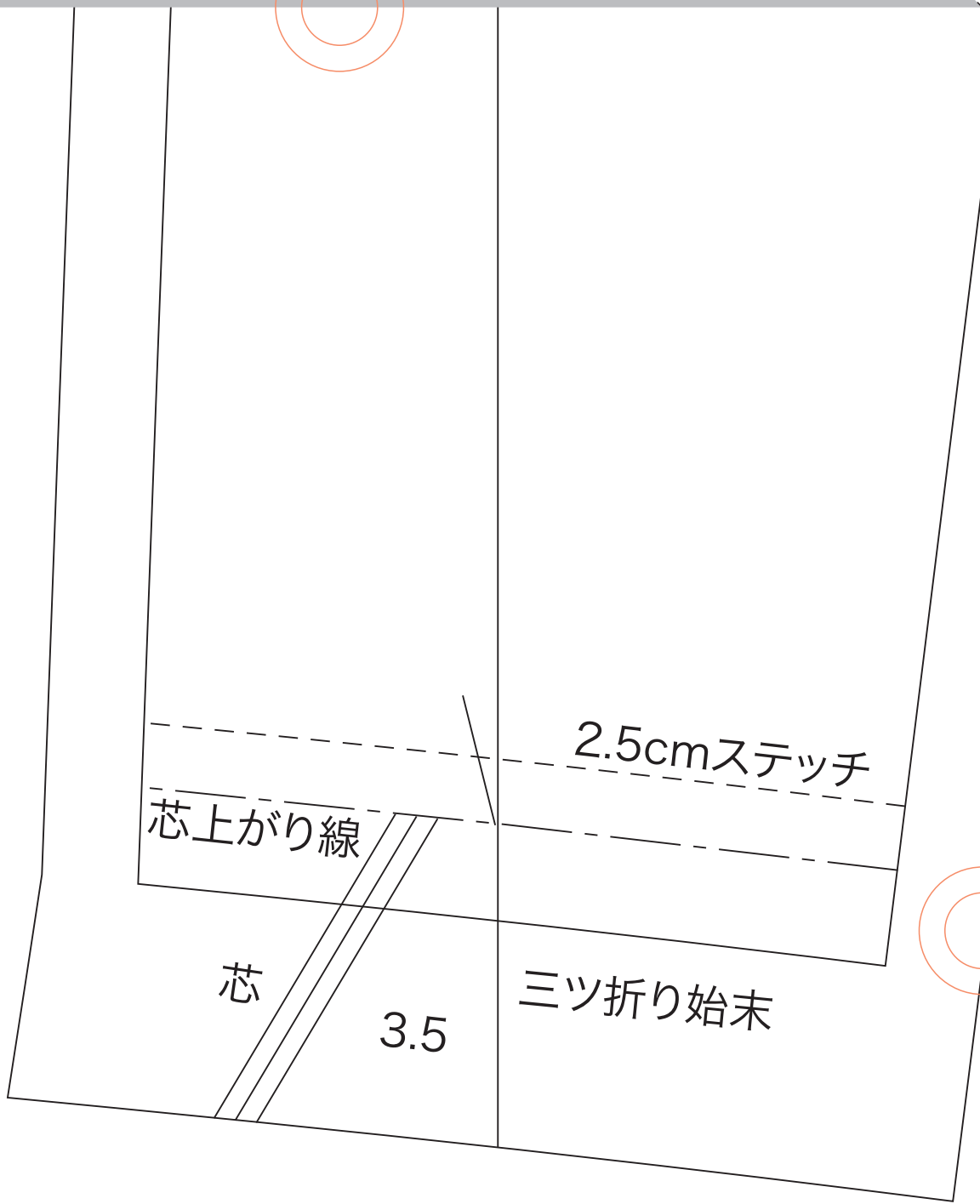

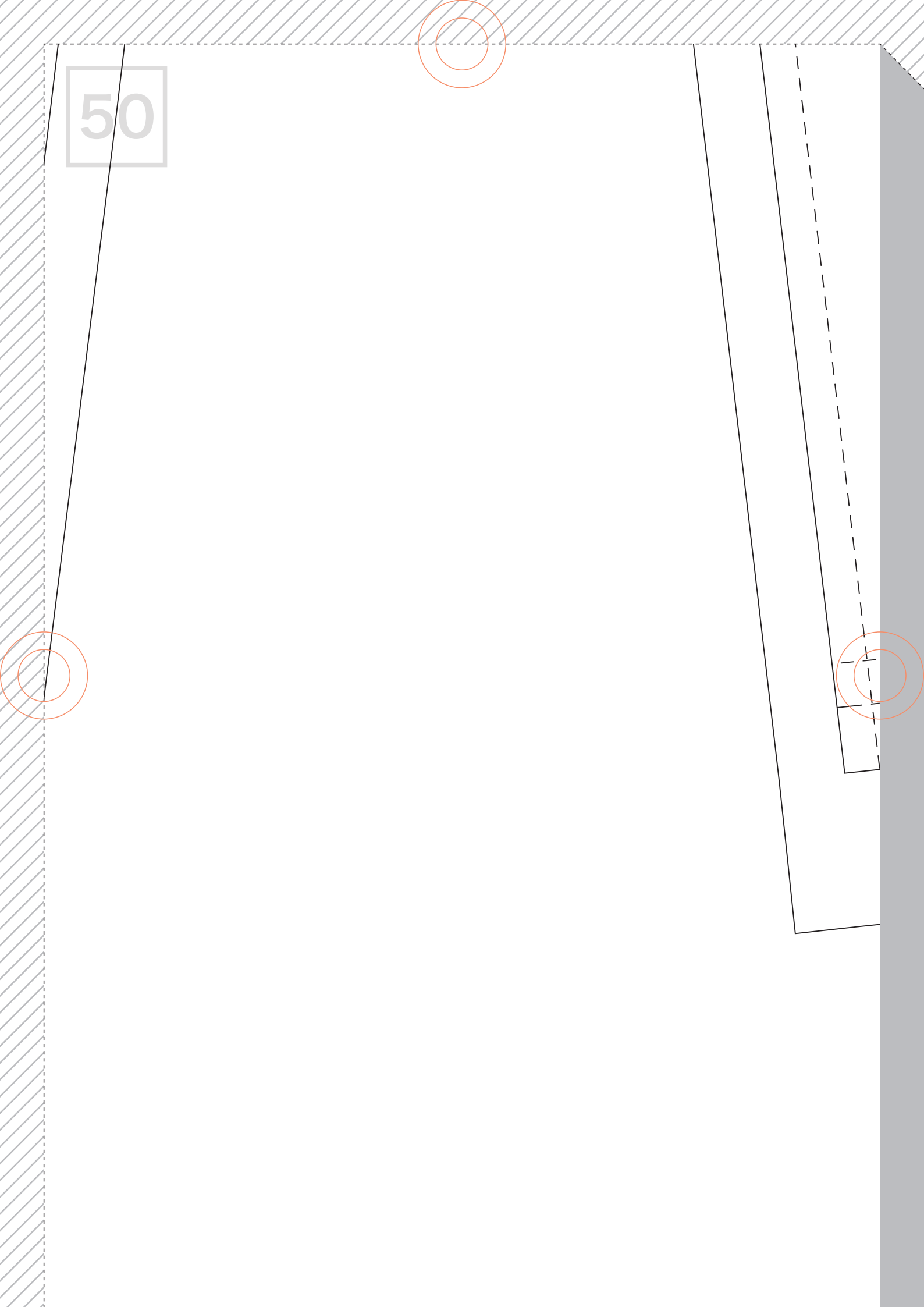

50

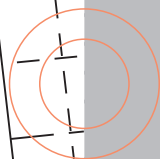
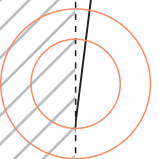
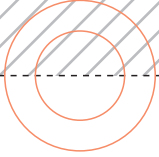

51

2.5cmステッチ

芯上がり線

三ツ折り始末

3.5

芯

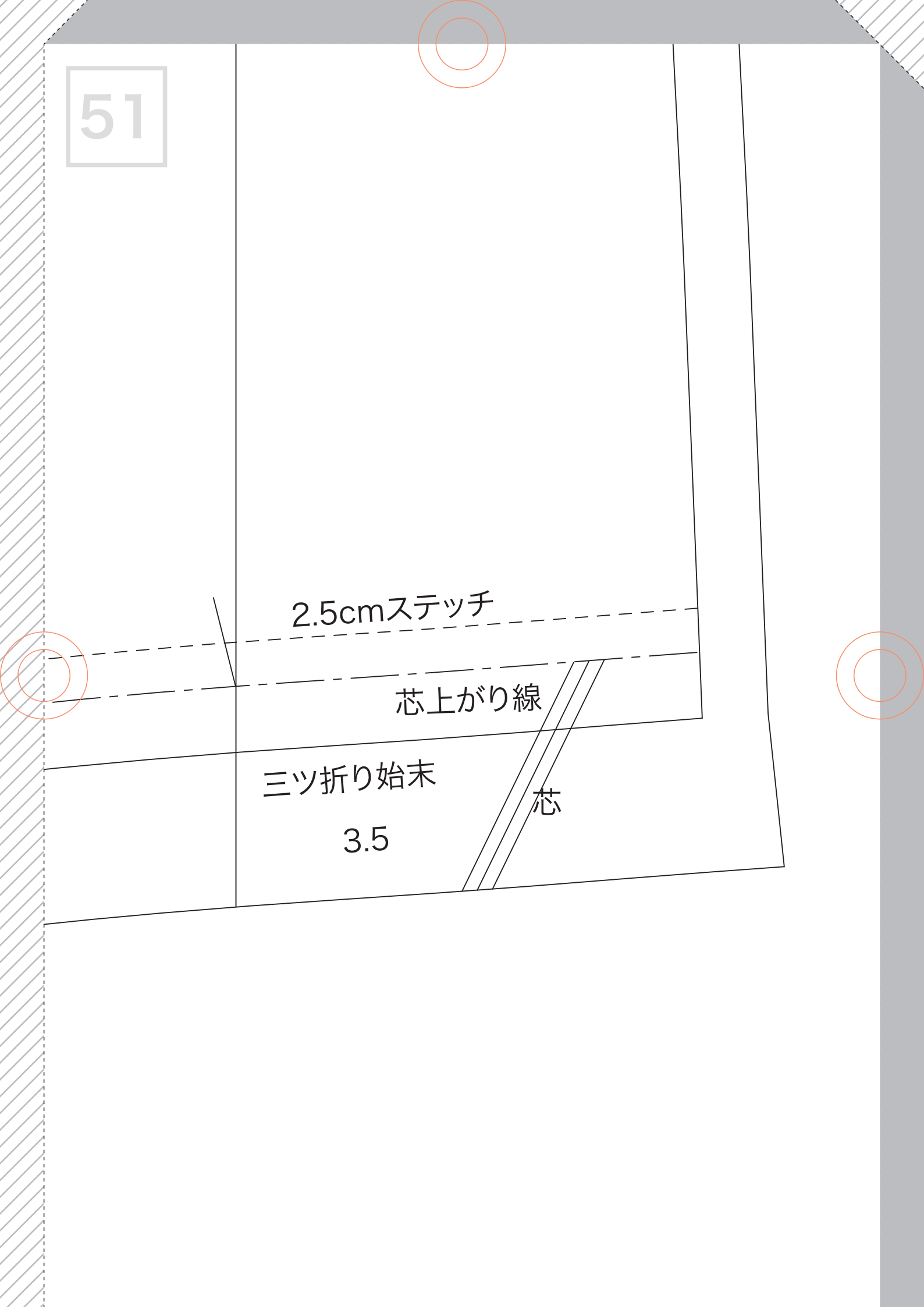

52

1.0

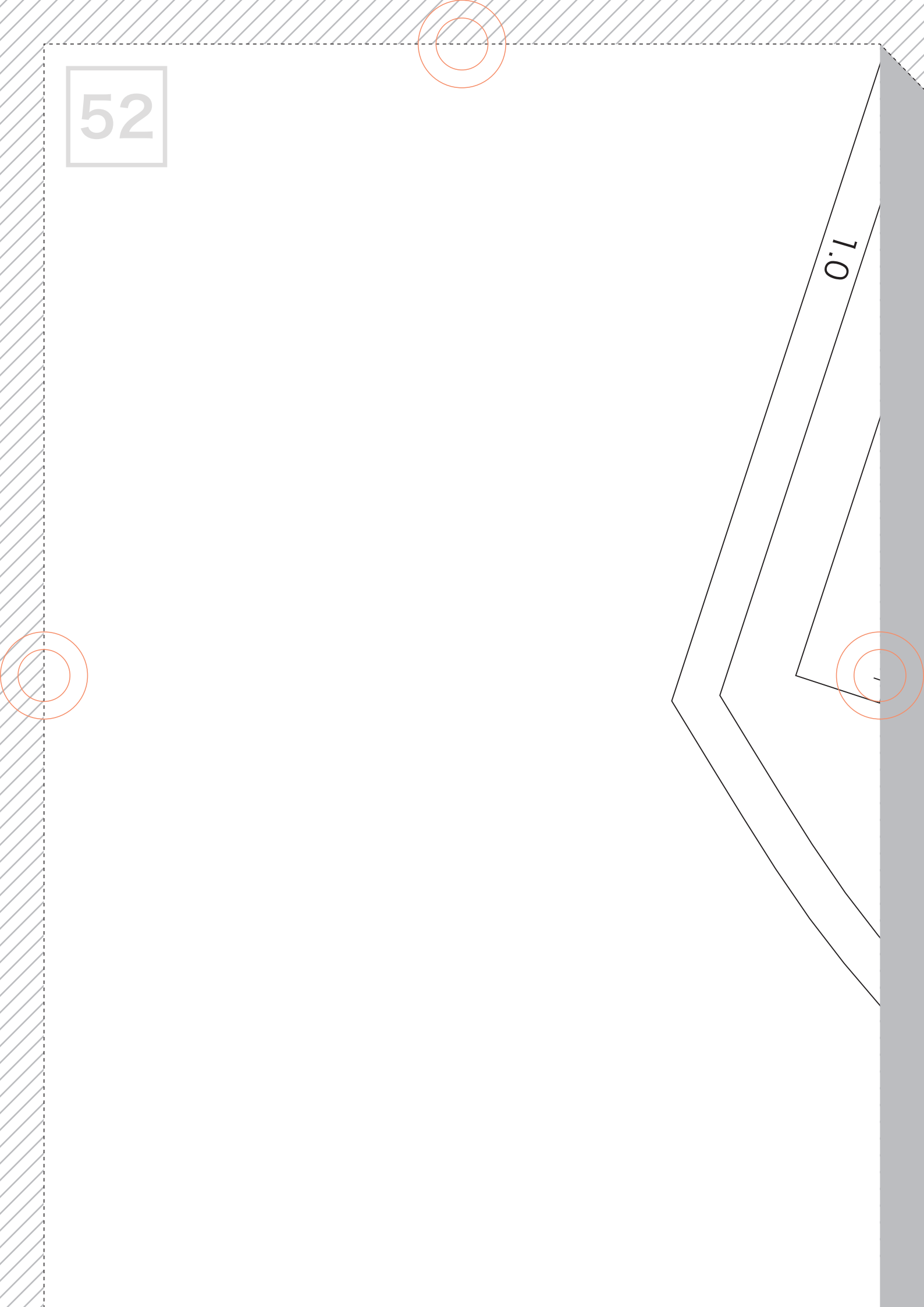

53

fabfab-13
箱ポケット袋布
size : 11
表×4枚

6mmバイアステープ始末

1.0

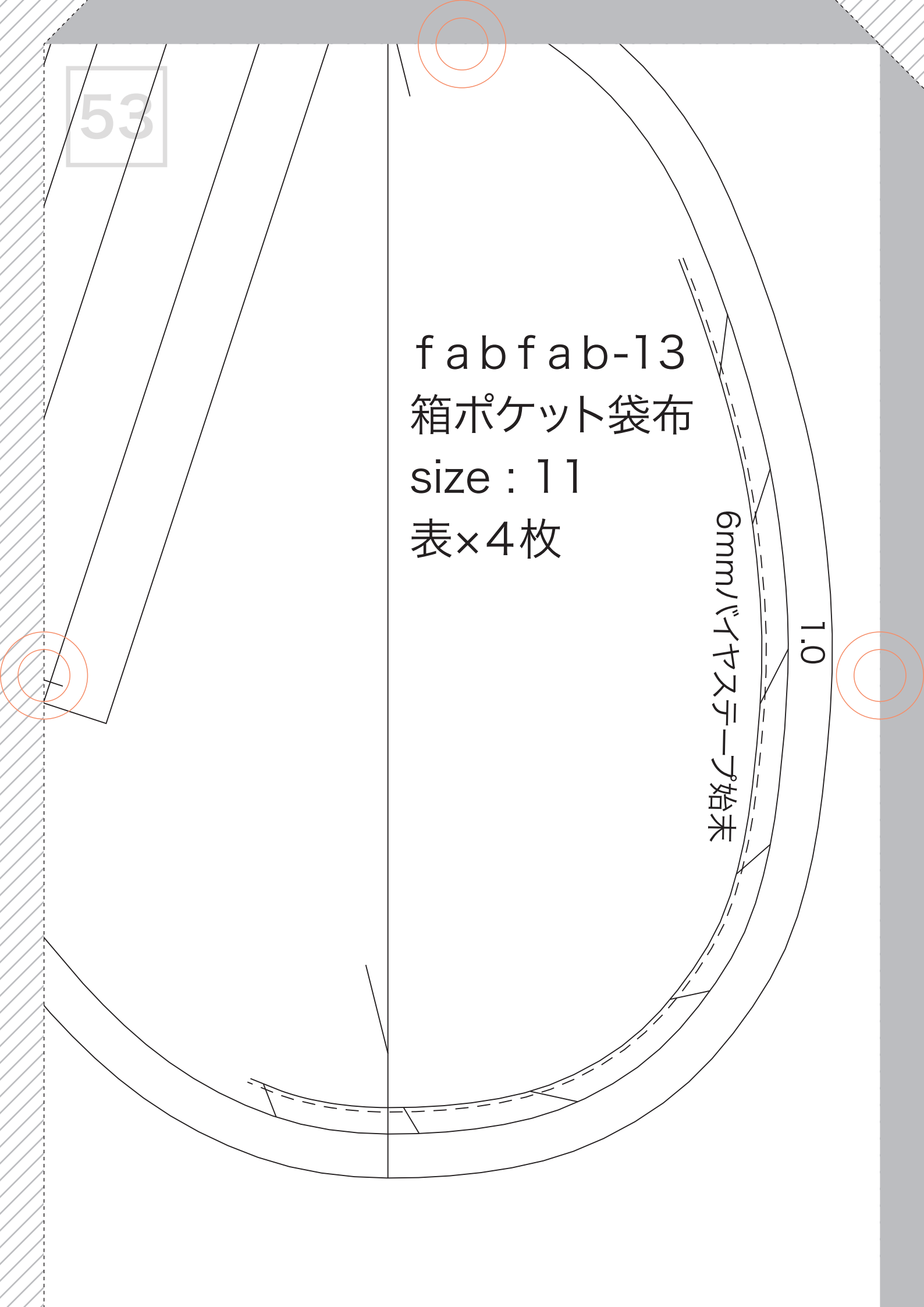

54

6mmバイヤステープ始末

