



introduction はじめに

パターンは A4 サイズ 54 枚に分割されています。
印刷後、右図のようにつなぎ合わせてください。

! 印刷時の注意

印刷設定では、「ページの拡大や縮小」を選択せず
必ず、「実際のサイズ」(原寸) で印刷してください。

how to make パターンのつくりかた

STEP1 斜線部分  は切り取り、灰色部分  は残してのりしろにします。
(斜線と灰色を間違えないように注意)

STEP2 各用紙の番号を確認し、 の位置を合わせて、のりづけします。
(水のりは用紙が波打ちます。スティック糊などをお使いください)

STEP3 それぞれのパーツをハサミで切り出します。

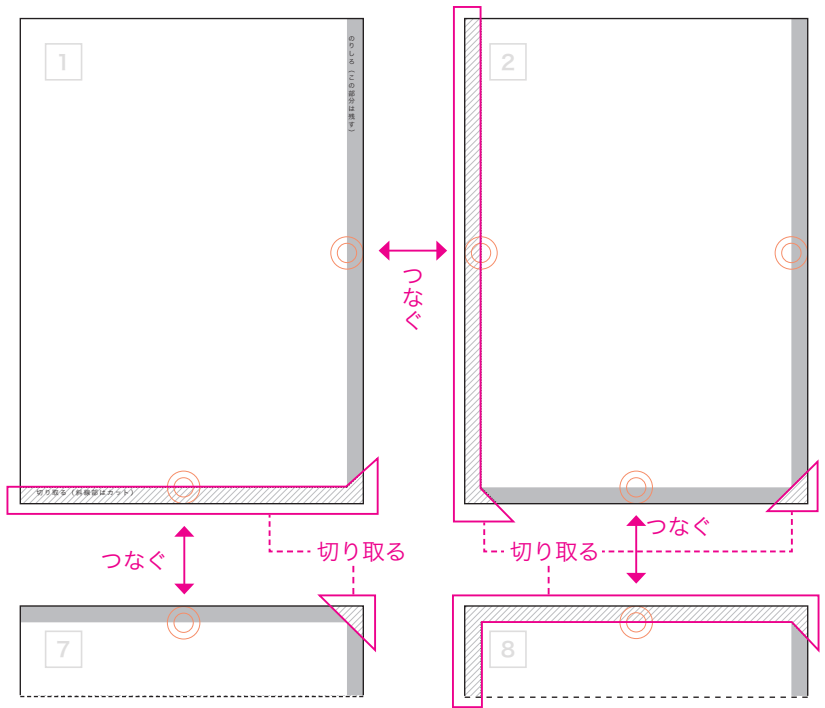
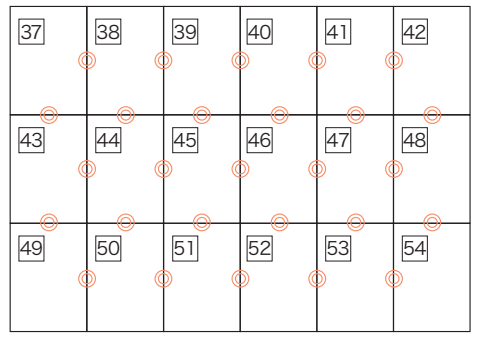
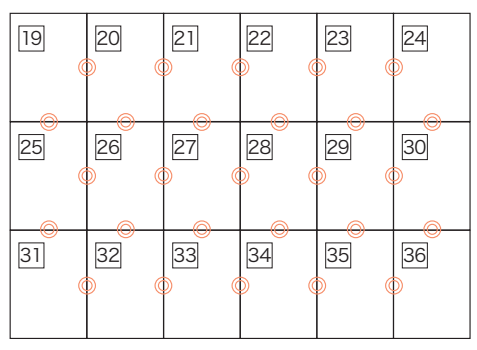
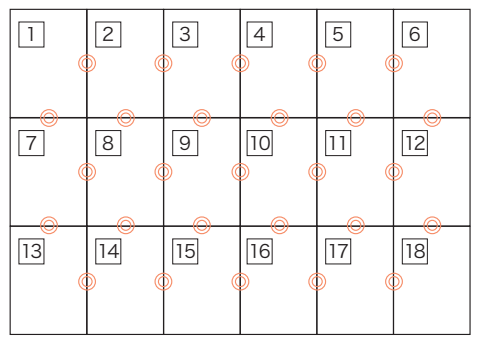

のりしろ (この部分は残す)

1

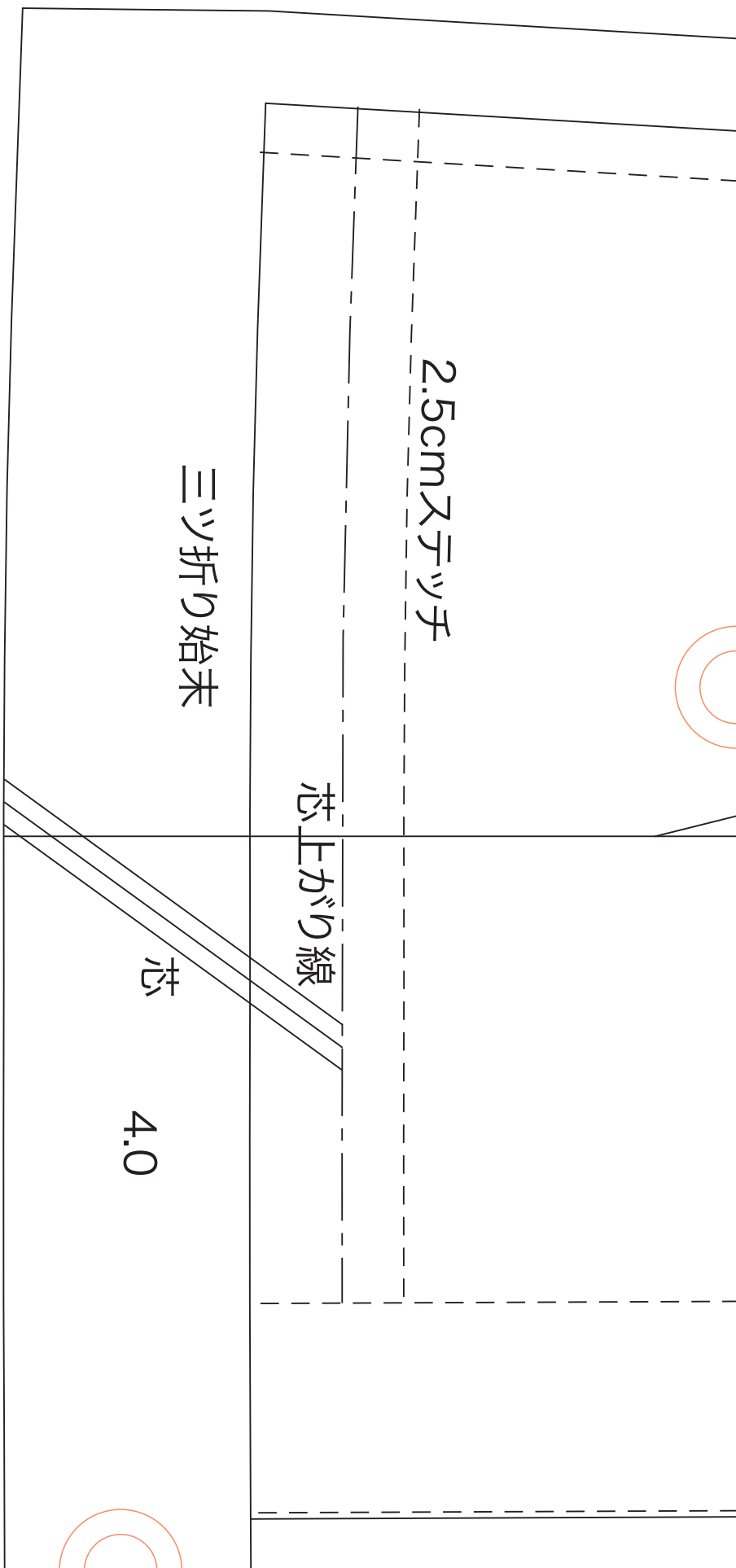

切り取る (斜線部はカット)

2

ベツ持ち出し押さえスツチ

松

コバースツチ

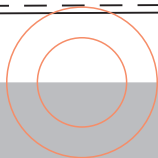
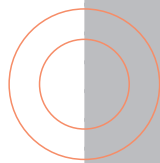
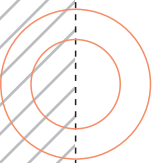

3

折り伏せ始末

0.8cmアツチ

折る

1.0

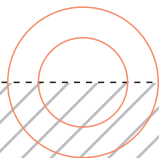
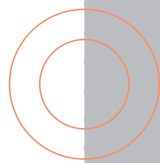
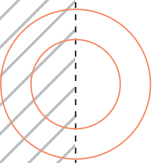

4

1.5

囊地上がり線

折り伏せ始末

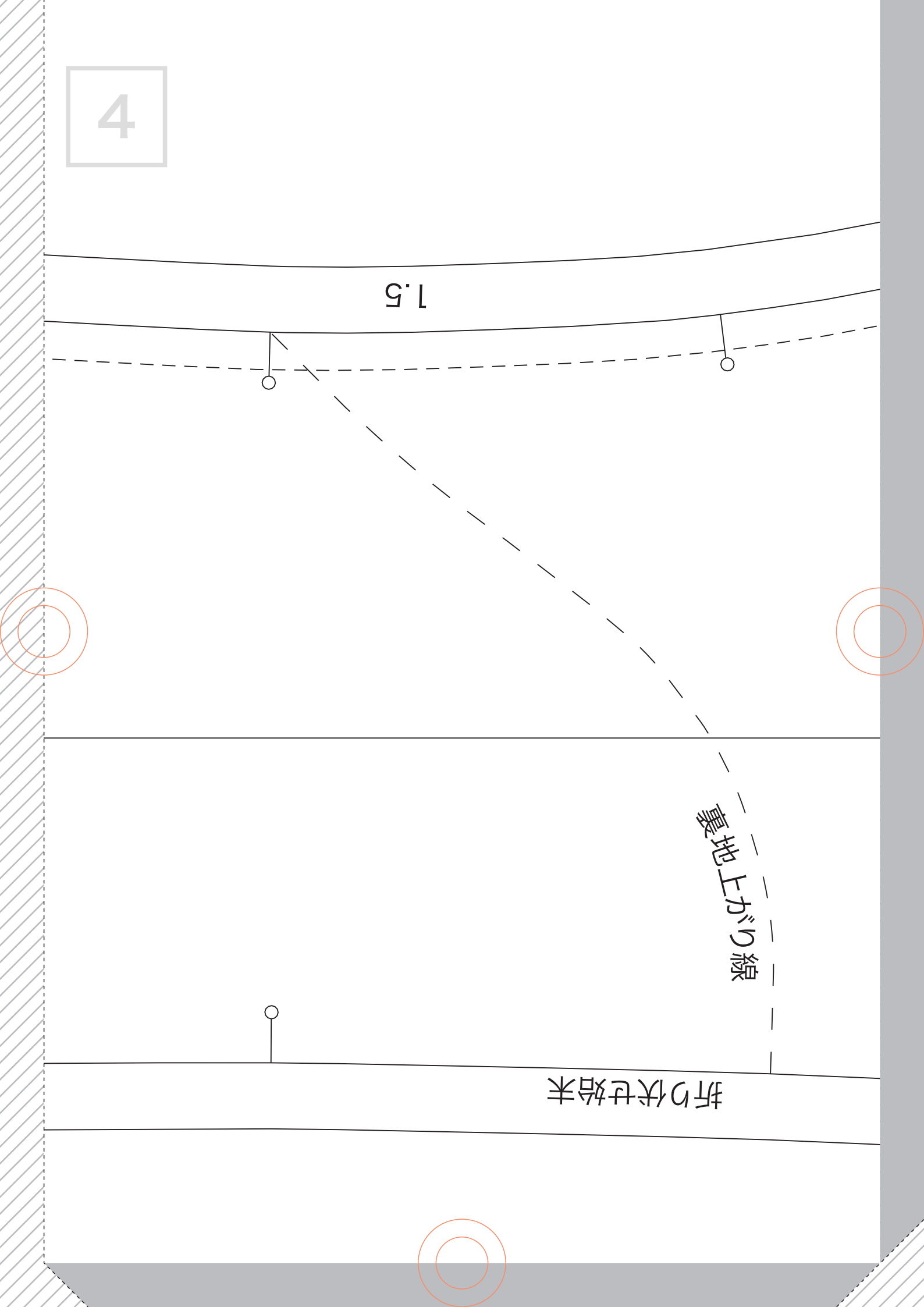
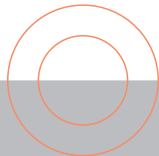
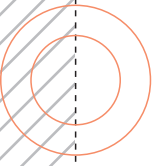

5

1.0

fabfab-13
左後身頃
size : 13
表×1枚

B・C

1.5

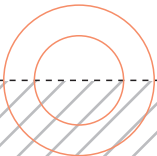
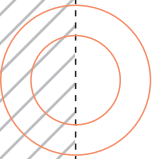

6

折り伏せ始末
0.8cmステッチ

1.5

0.5cmステッチ

1.0

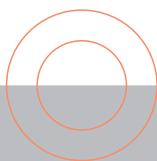

7

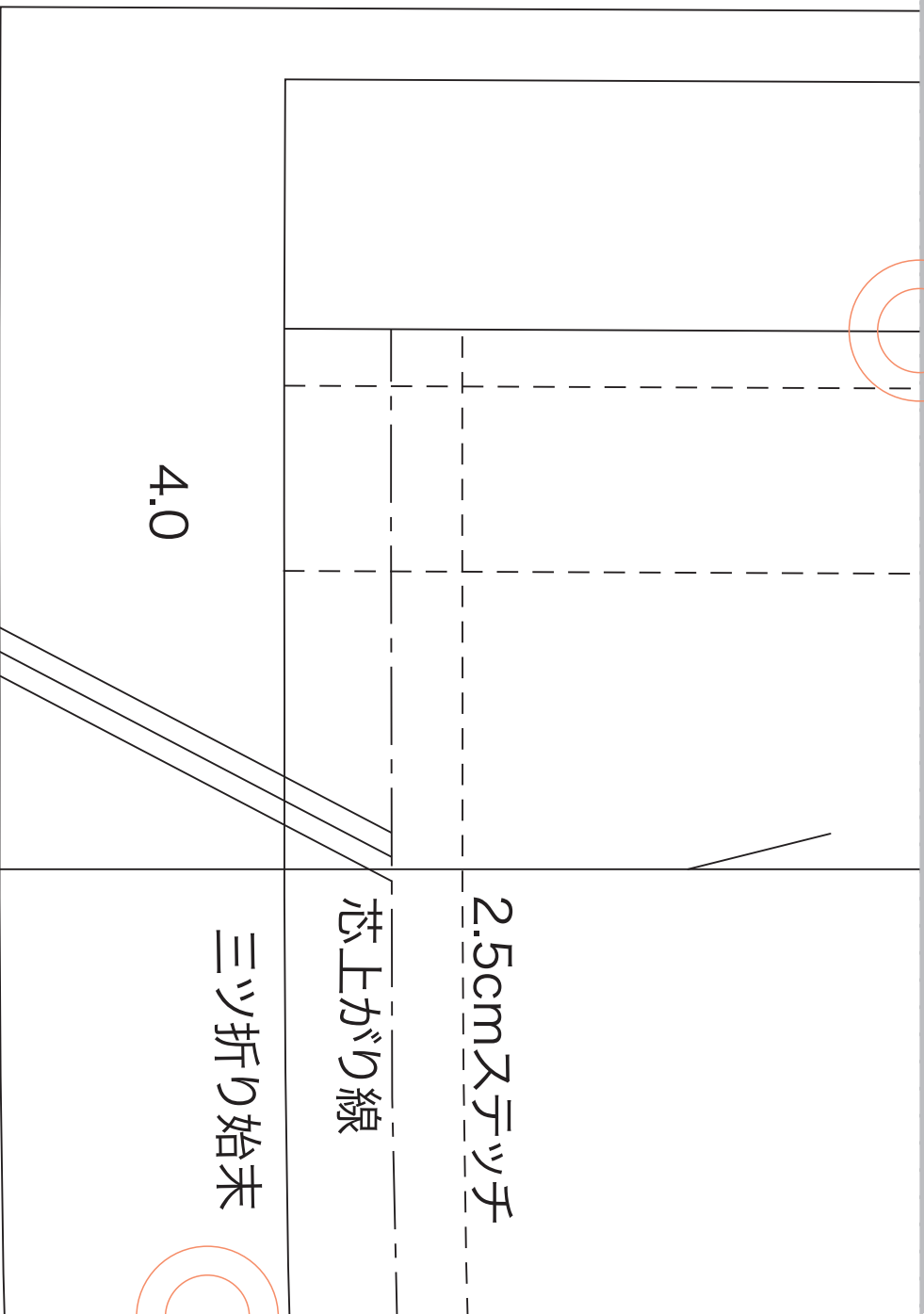

8

1.0

1.0

枠

ペッツ見返し押さえタッチ

9

1:0

100

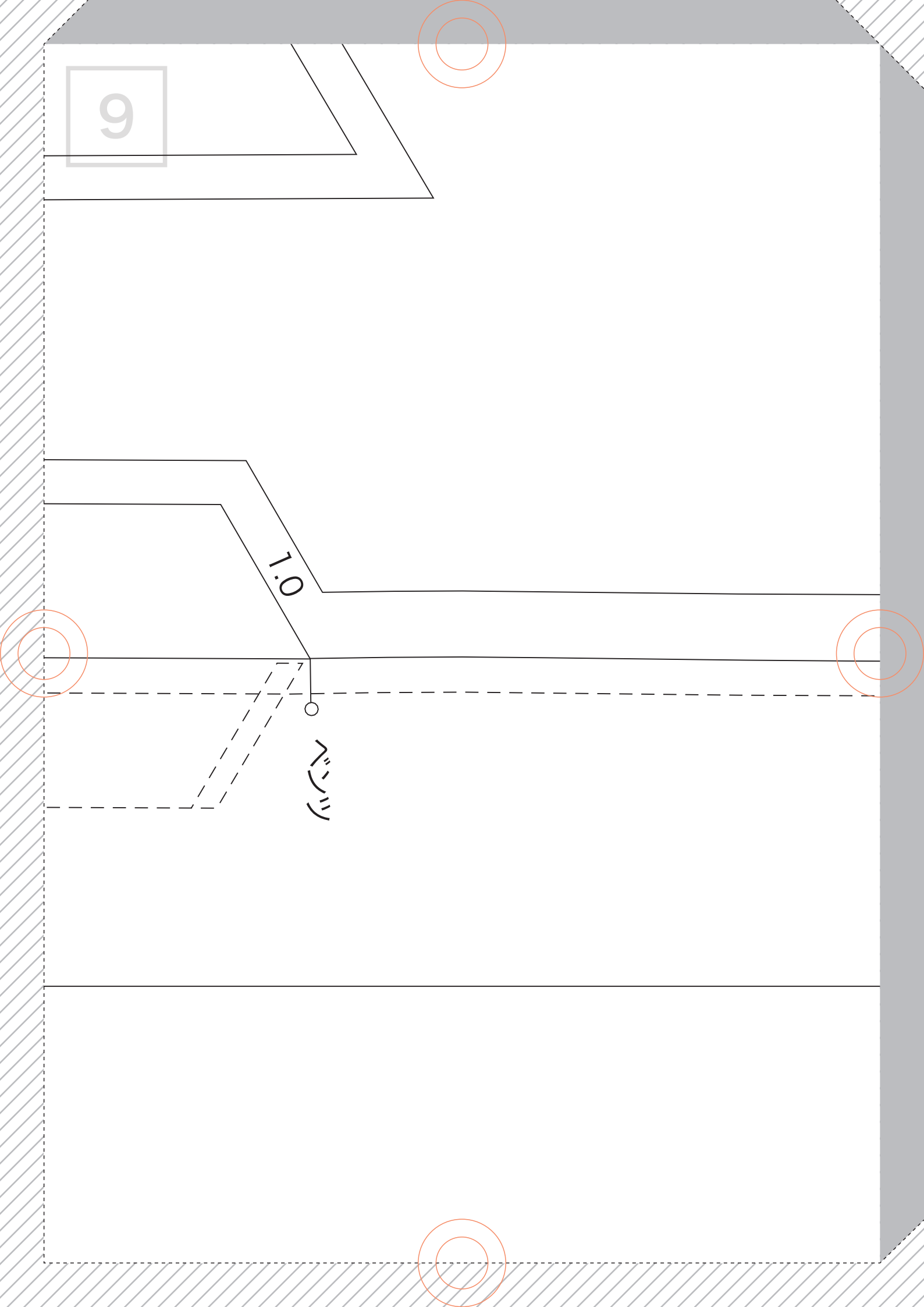

10

折り伏せ始末

裏地上がり線

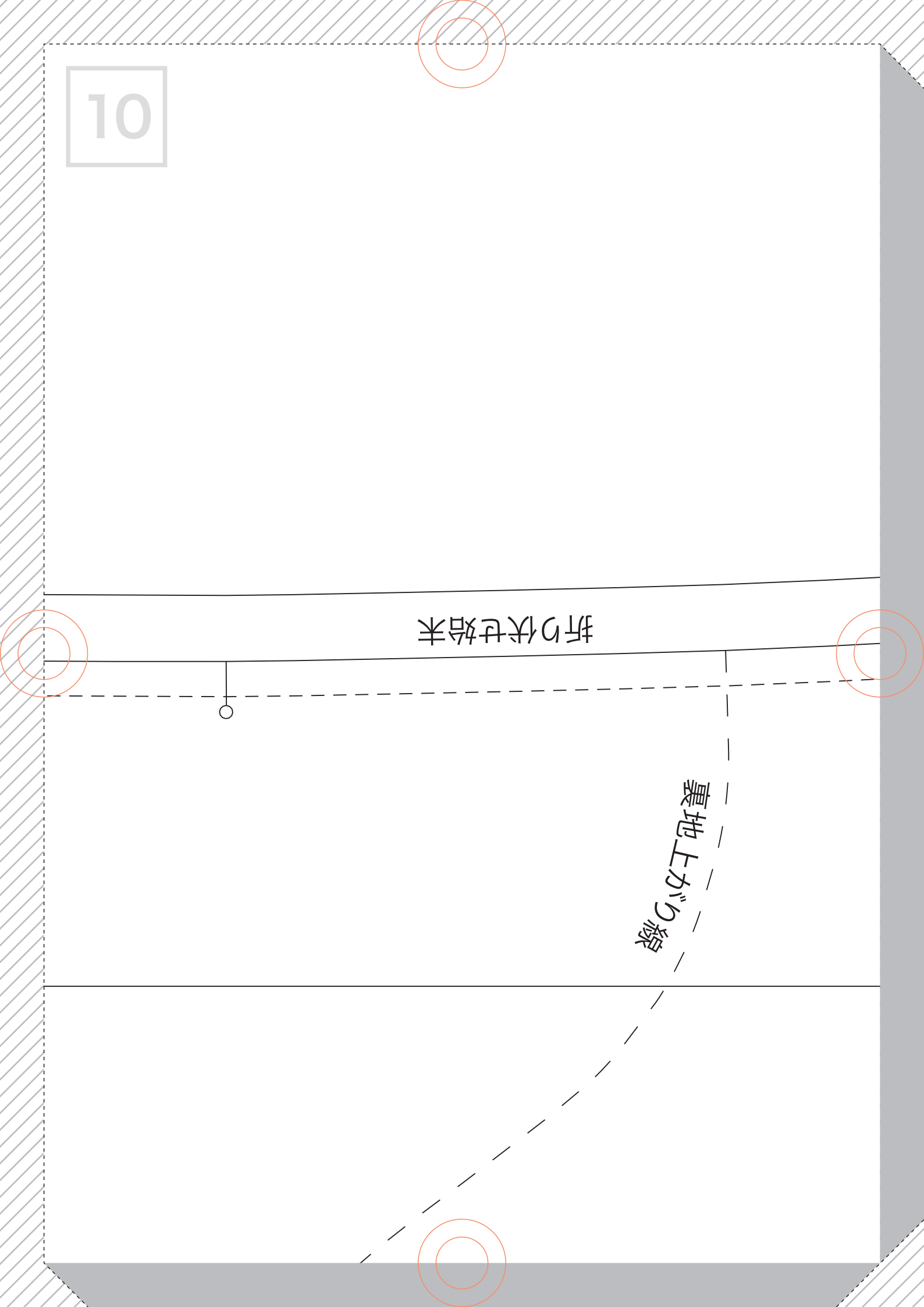

11

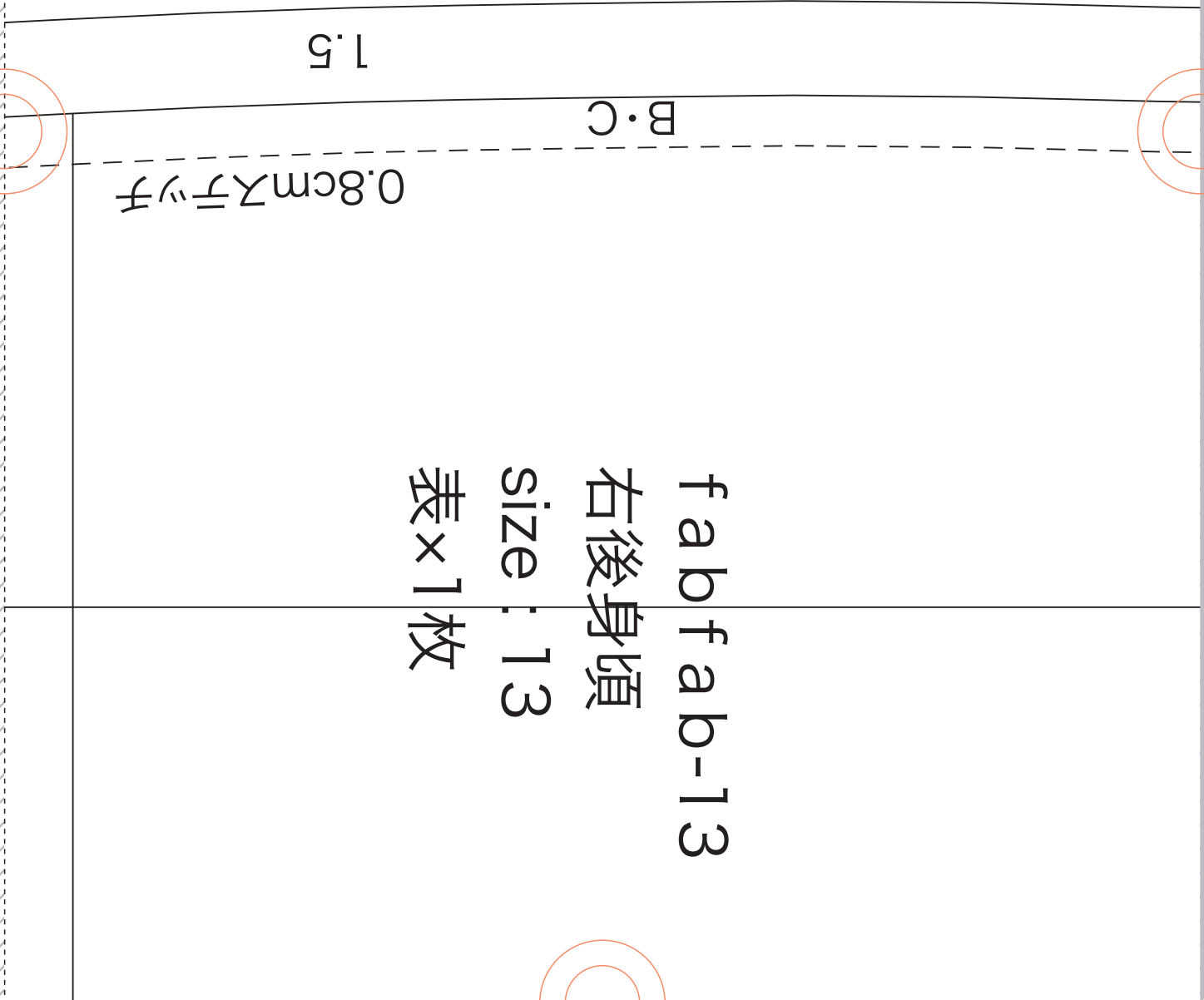

fabfab-13

右後身頃

size : 13

表×1枚

12

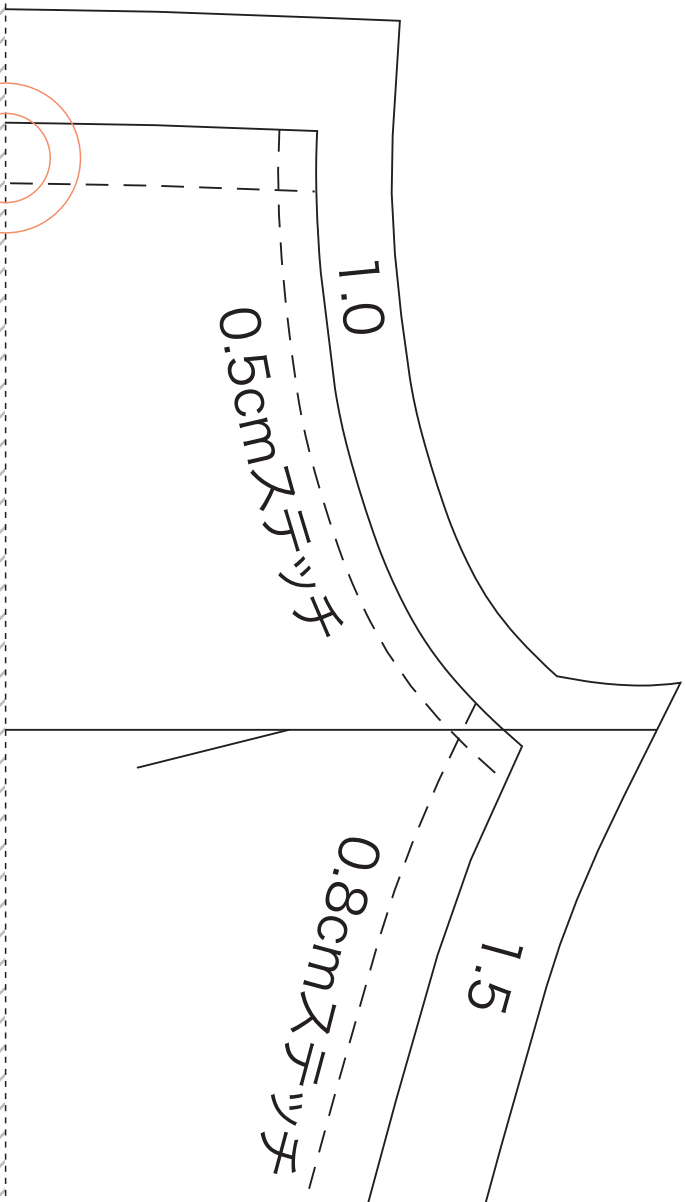
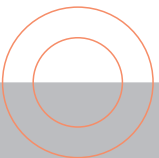
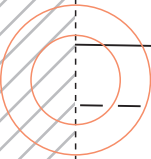
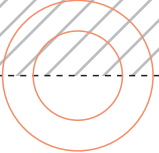

13

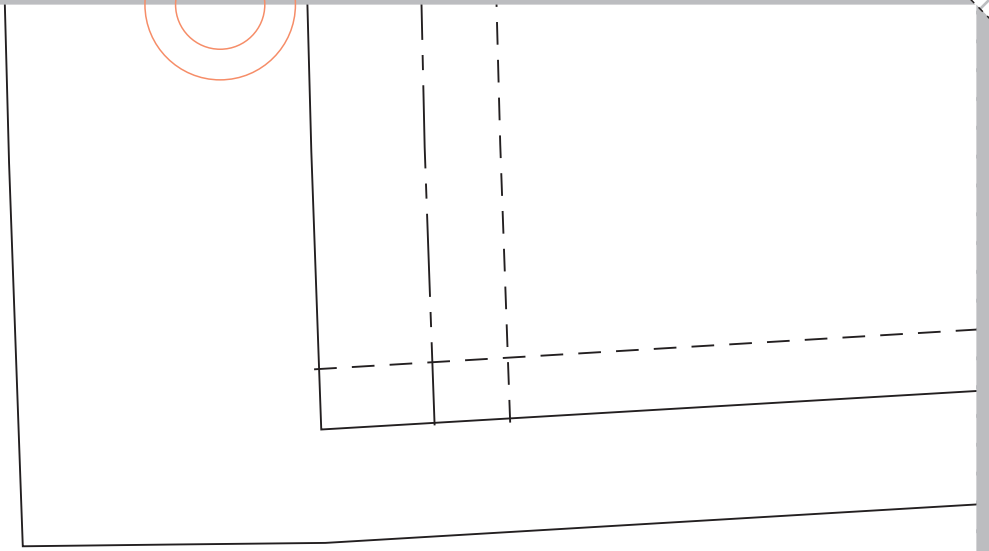

14

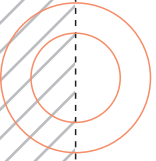
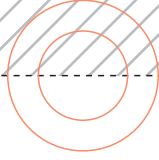

1.0

F.C

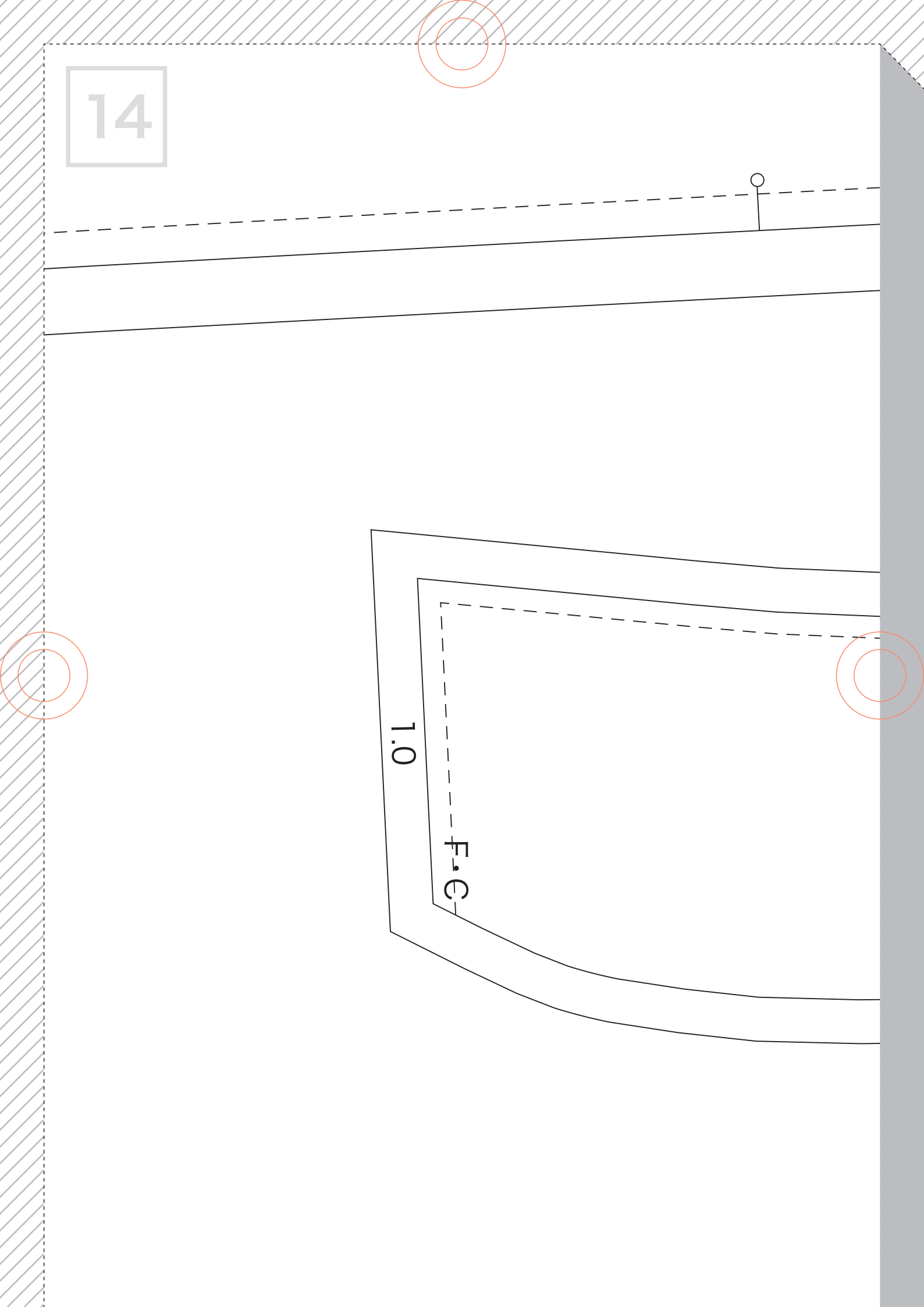

15

0.8cmステッチ

折り伏せ始末

0.5cmステッチ

N · P

B · C

1.0

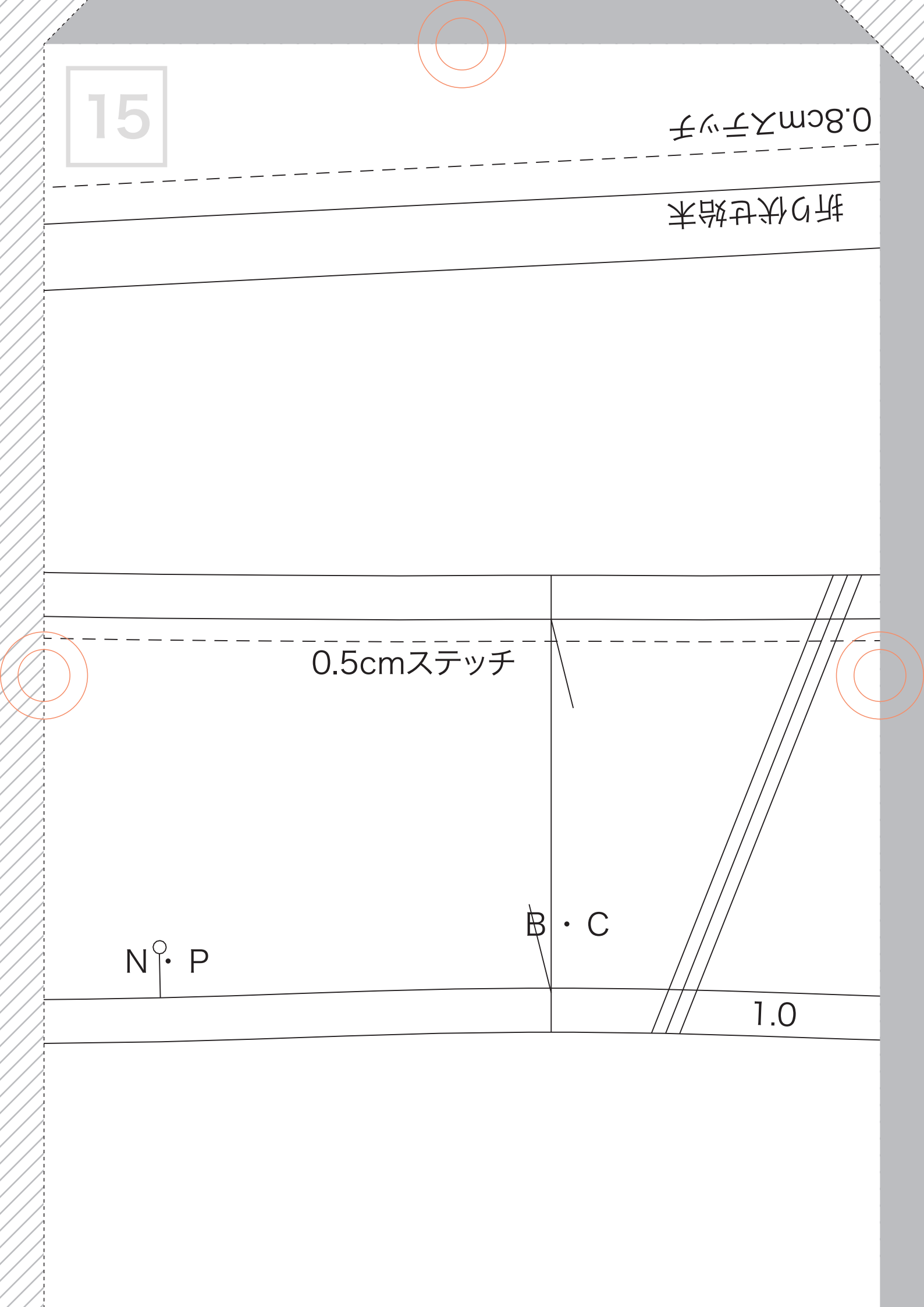

16

1.5

1.0

1.0

fabfab-13

衿

size : 13

表×2枚

芯×2枚

N · P

F · C

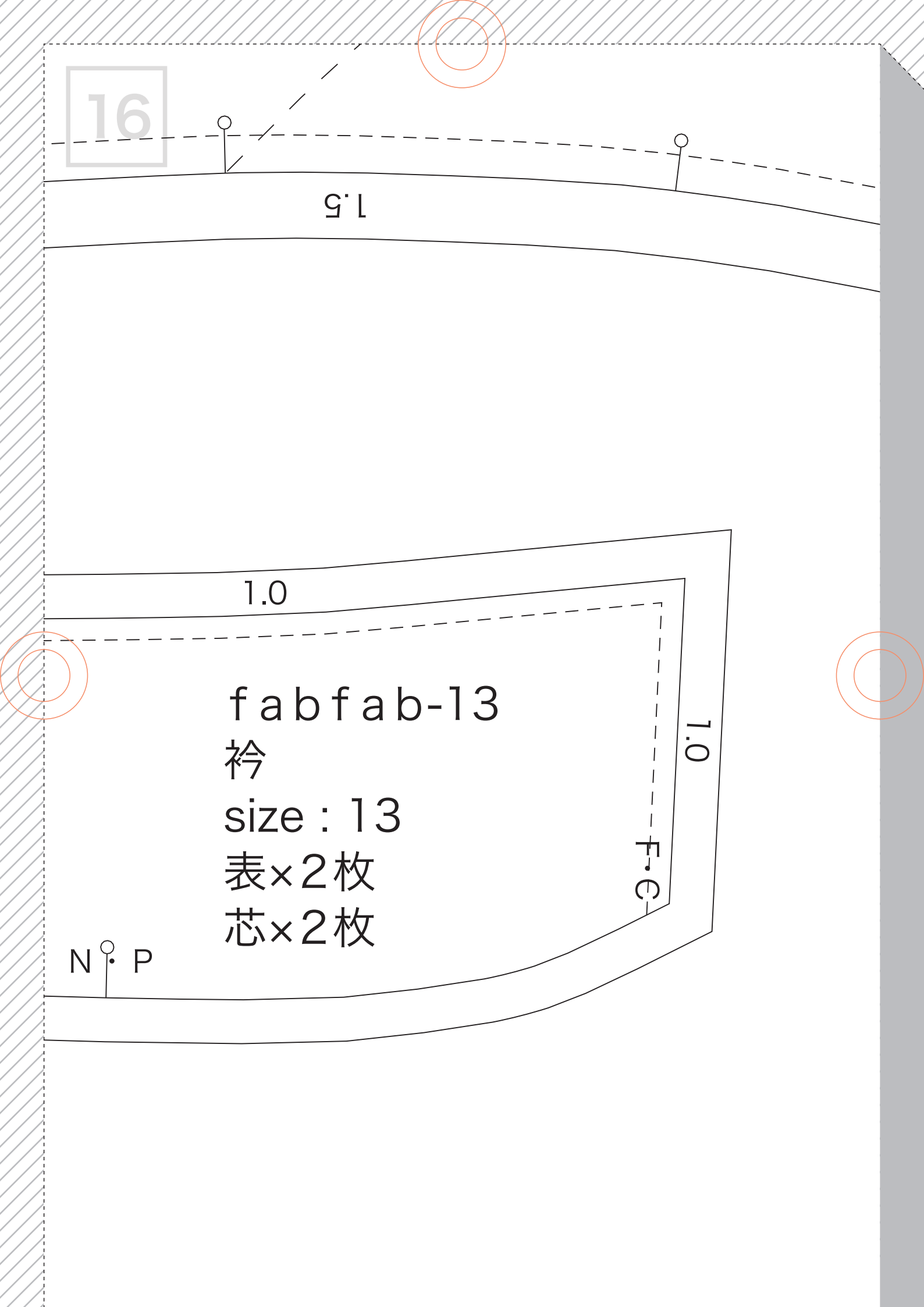

17

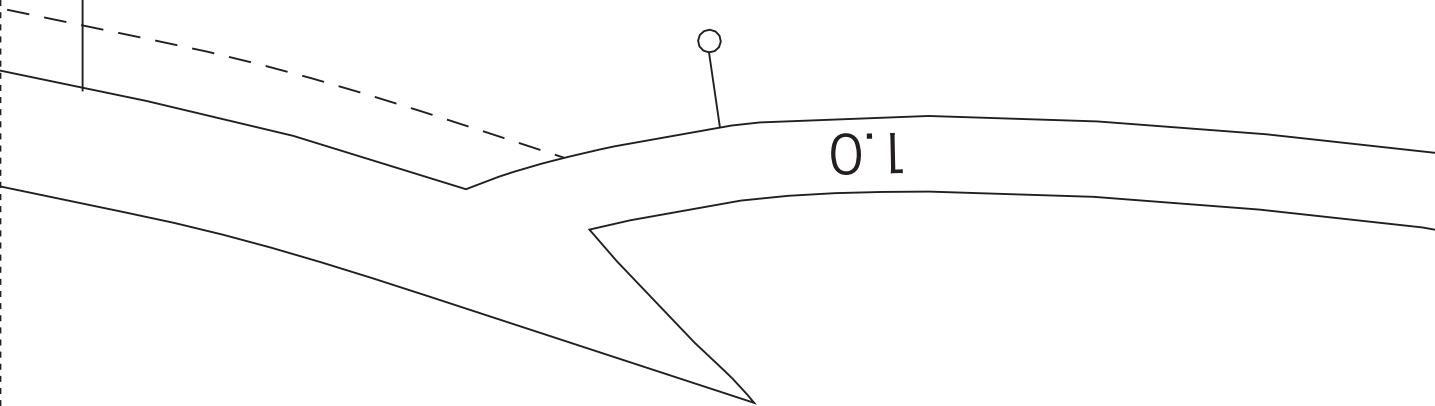

0.1

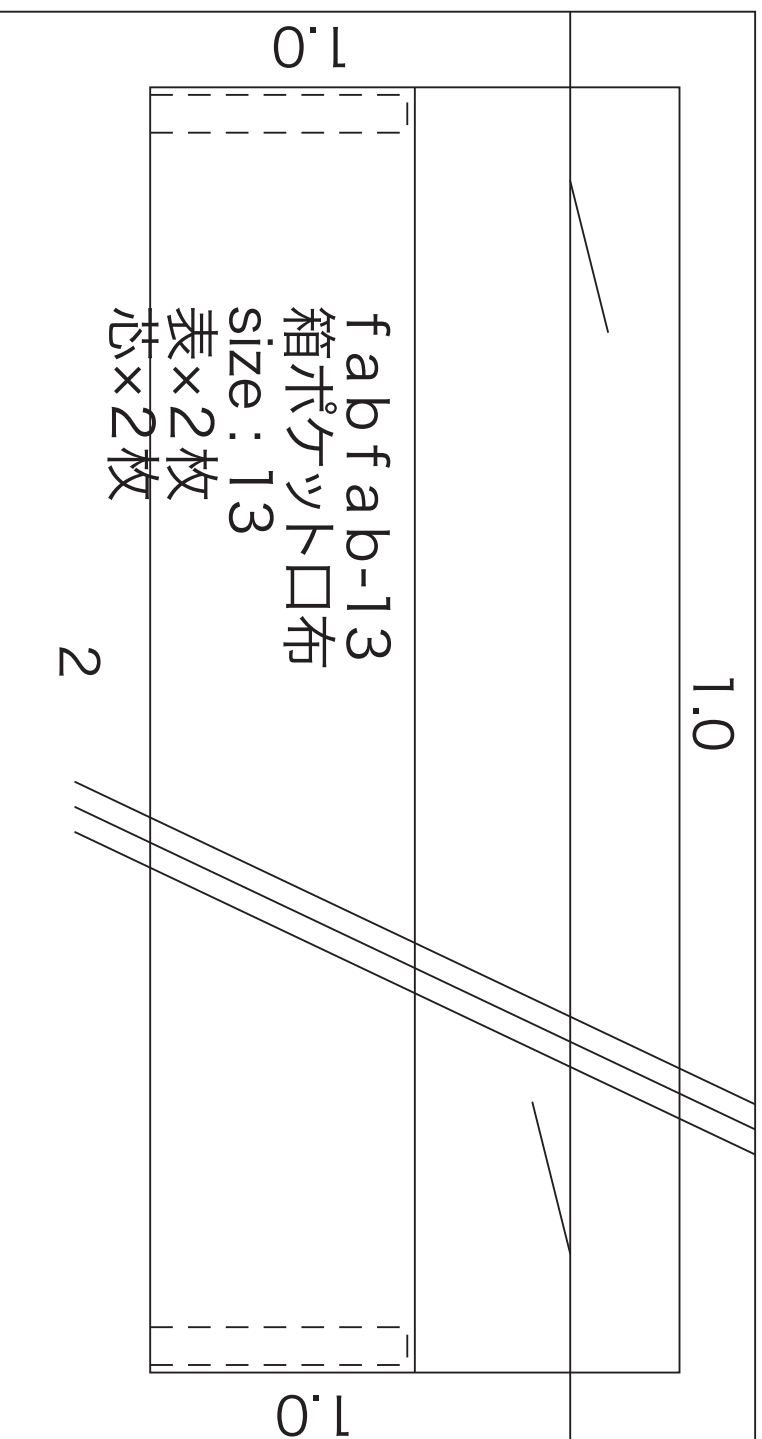

折り伏せ始末

18

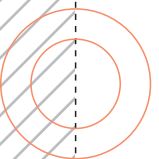
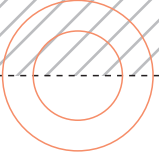

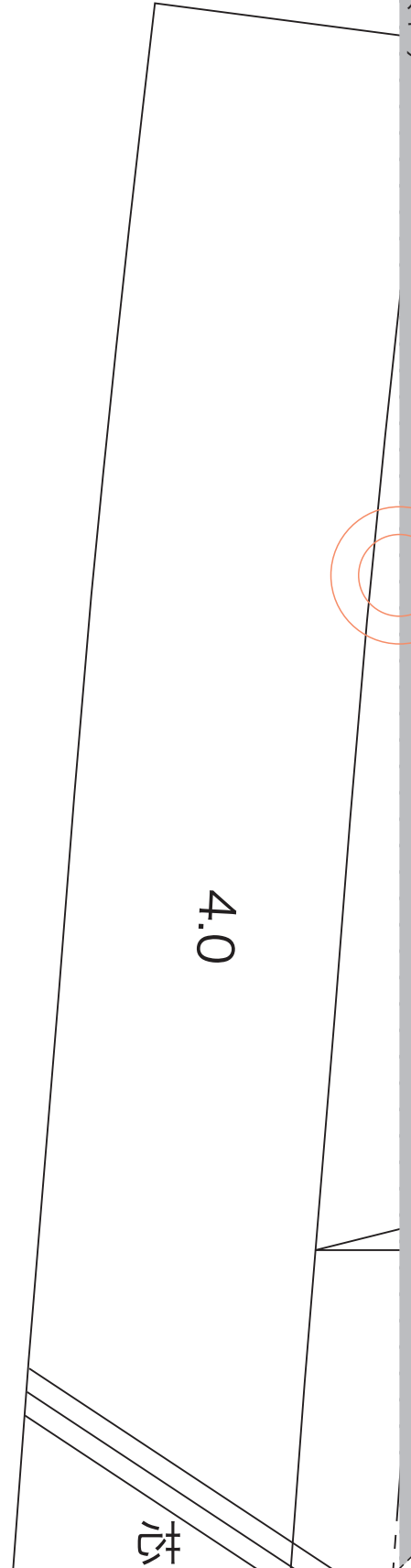

切り取る (斜線部はカット)

20

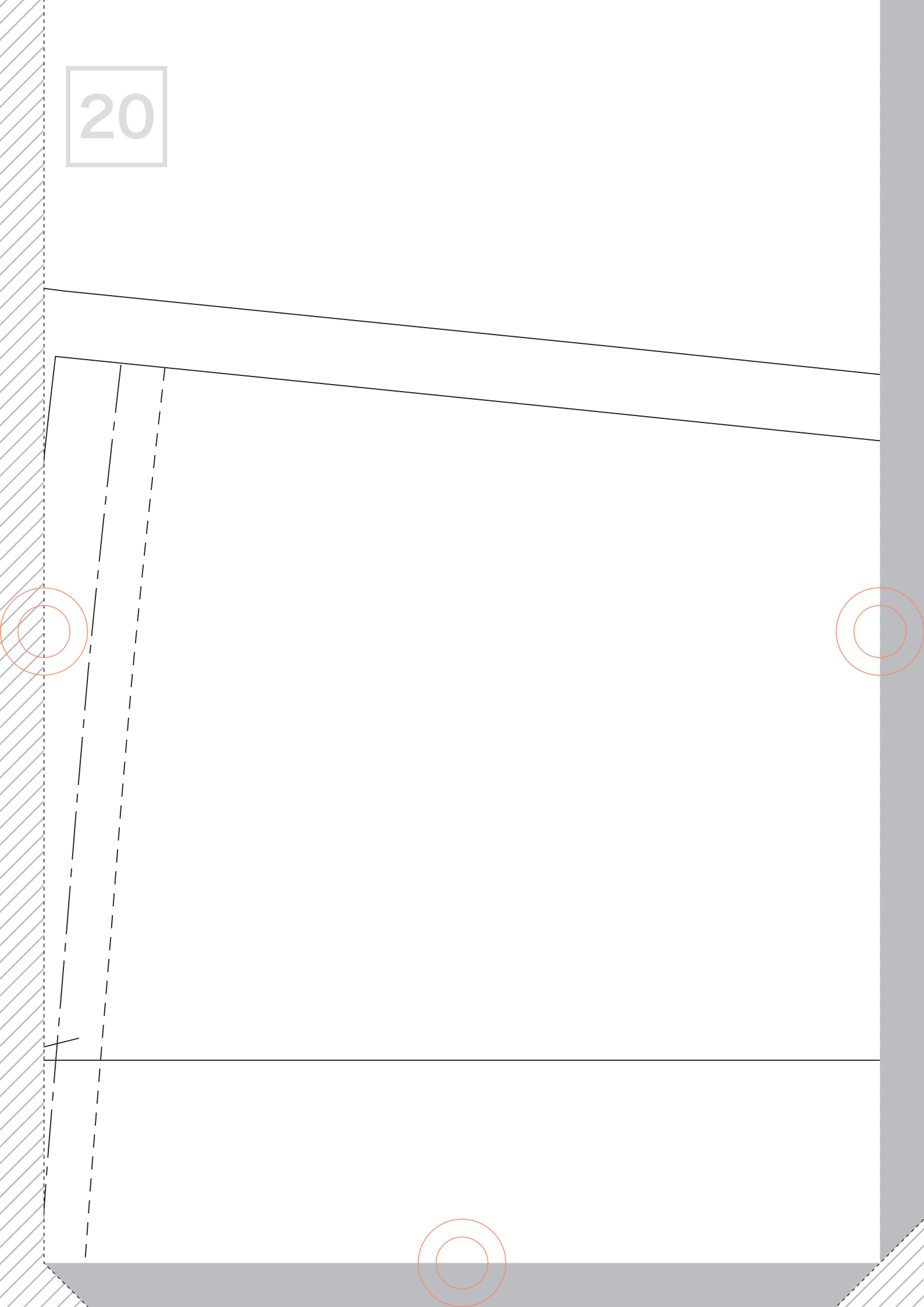

21

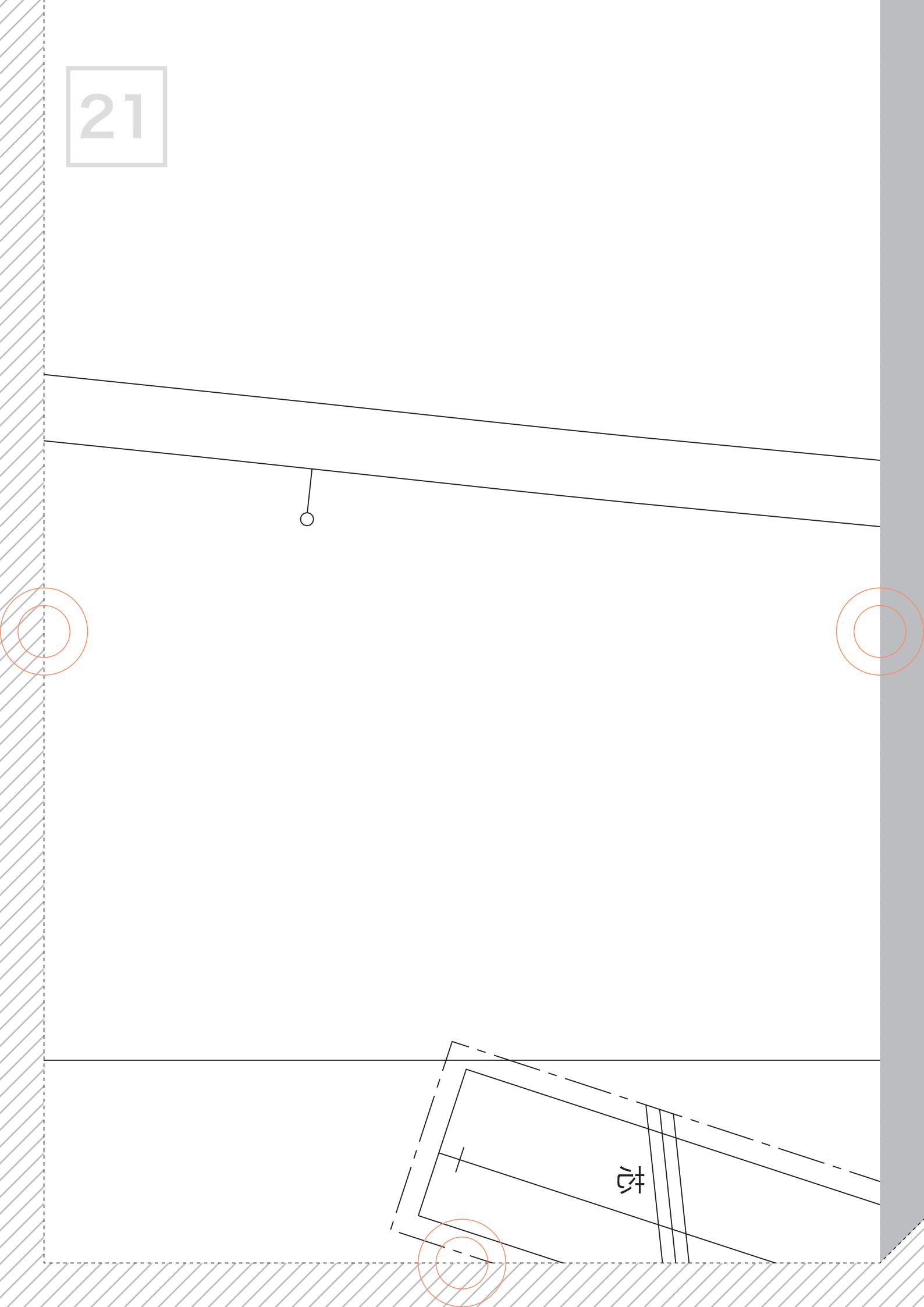

22

折り伏せ始末

1.5

裏地上がり線

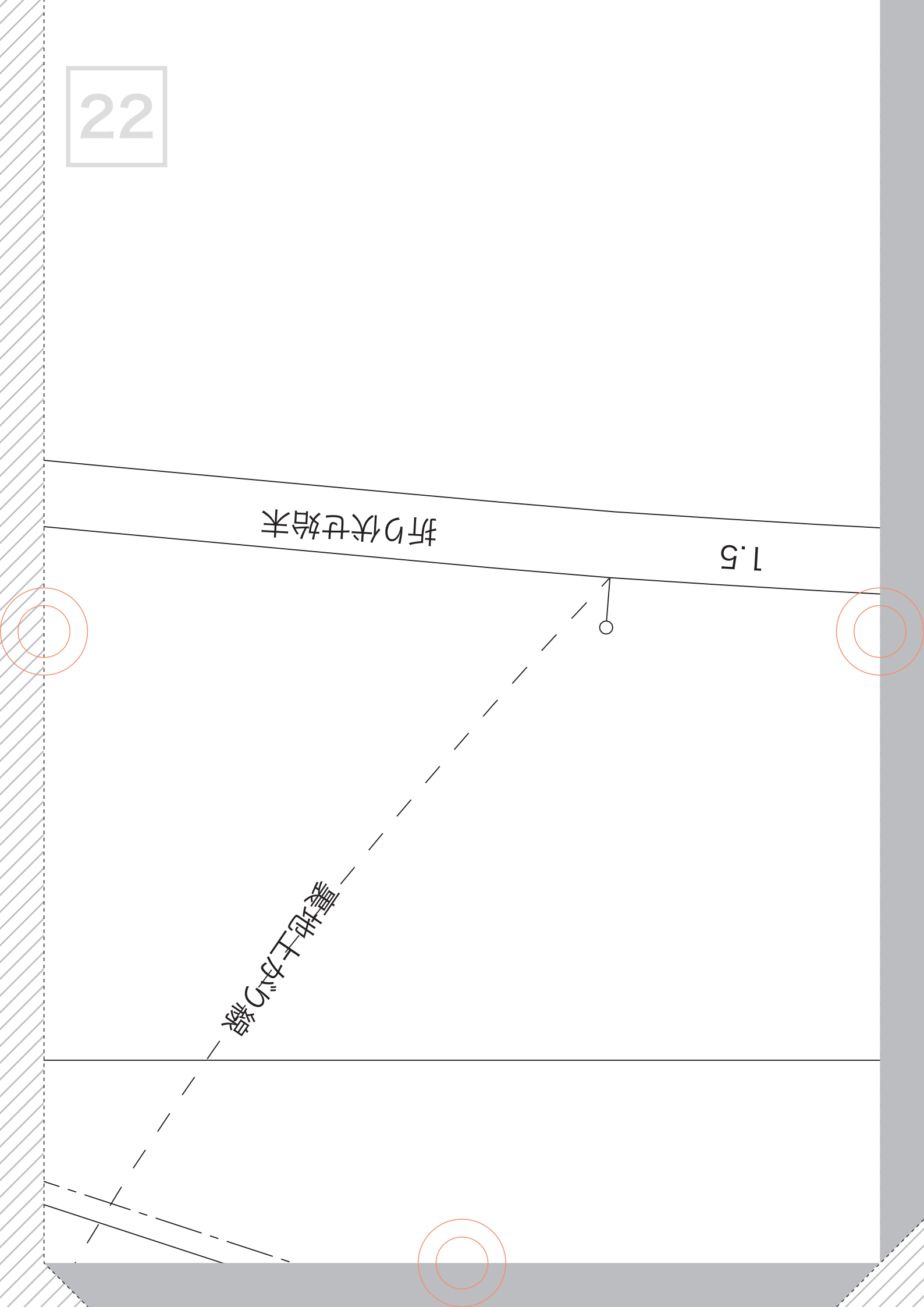
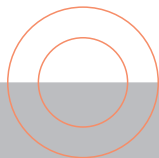
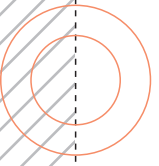

23

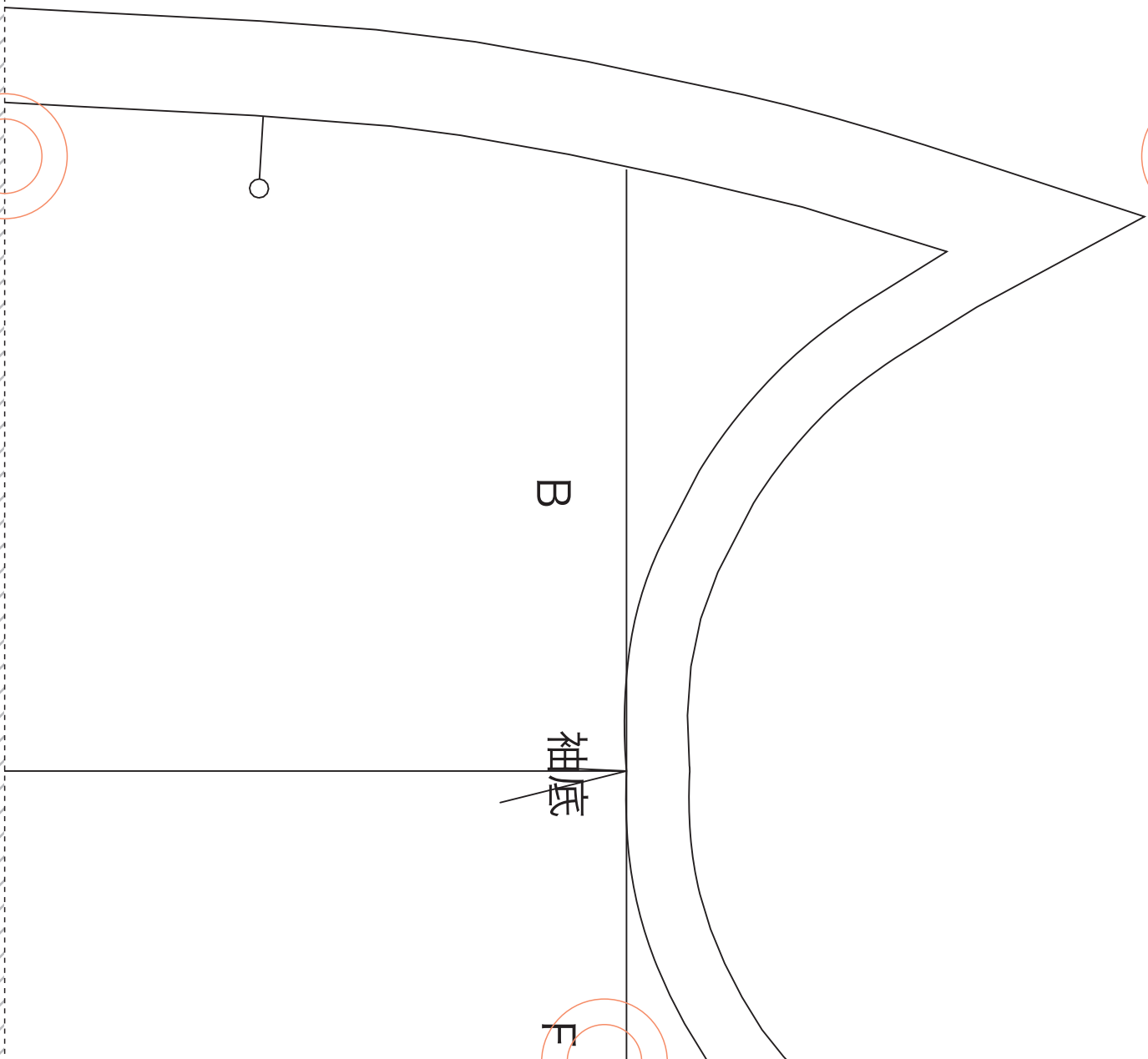

24

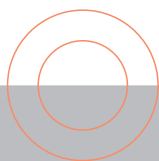
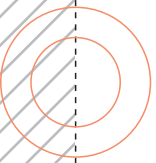

芯上がり線

ミツ折り始末

25

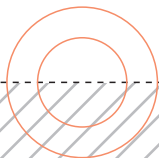
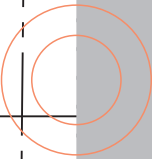
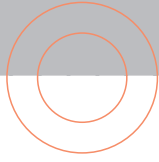

26

2.5cmステッチ

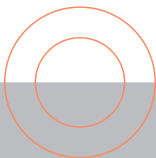
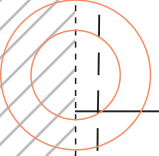
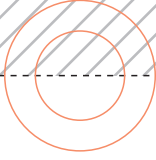

27

口布のまわり芯貼る

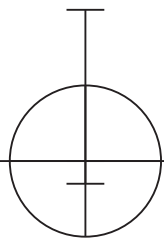
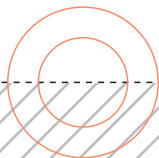
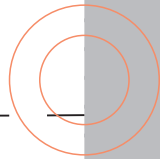
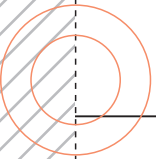
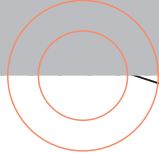

切り込み位置

箱ポケット

28

見返し線

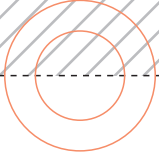
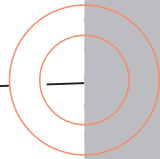
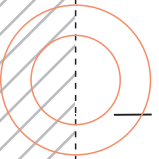
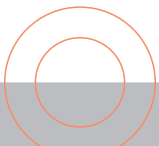
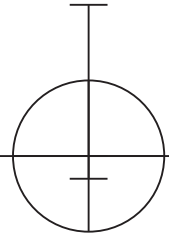
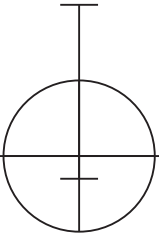

29

f a b f a b - 1 3

前身頃

size : 13

表×2枚

芯上かり線

芯

F・C

0.5cmヌツチ

1.0

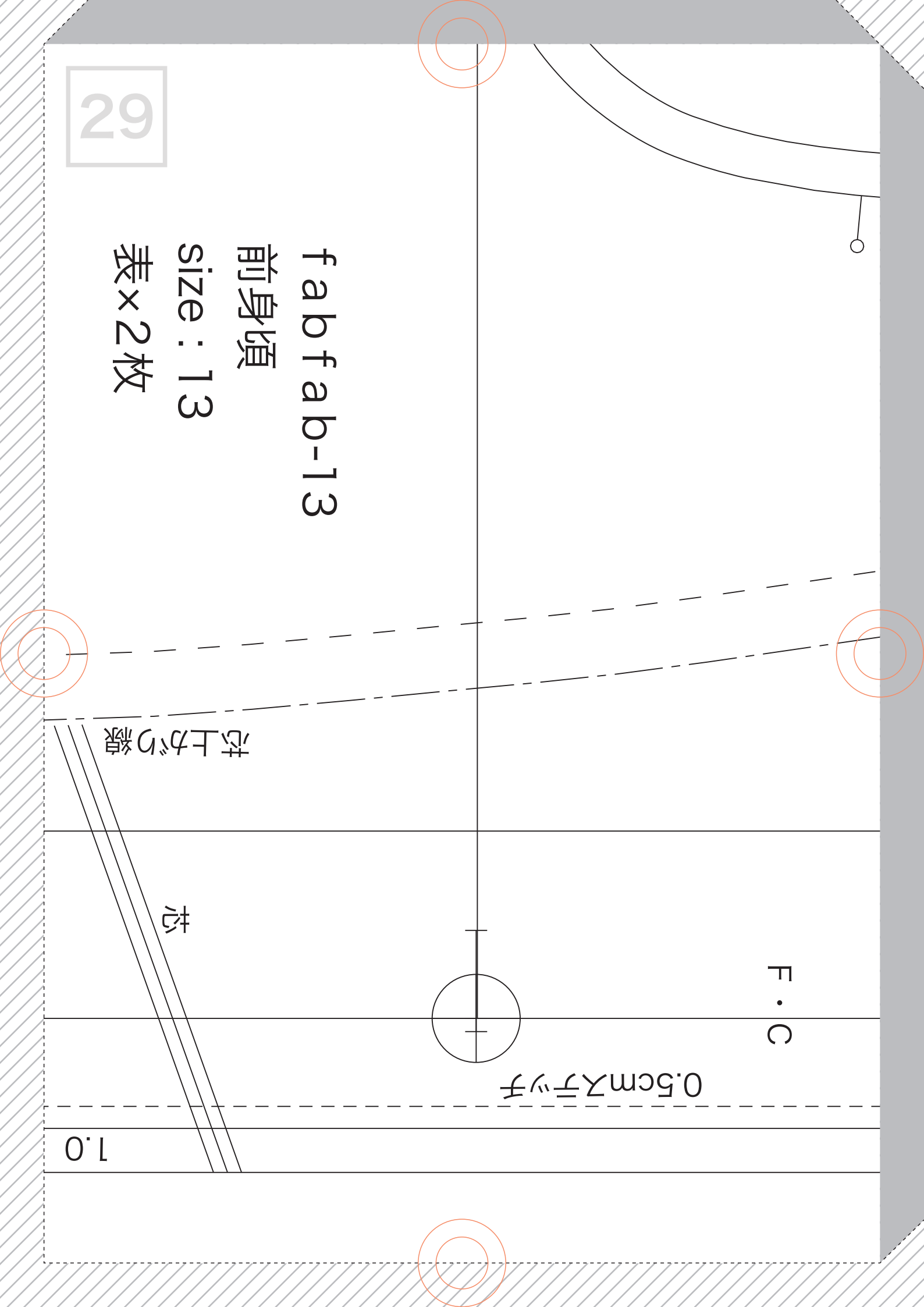

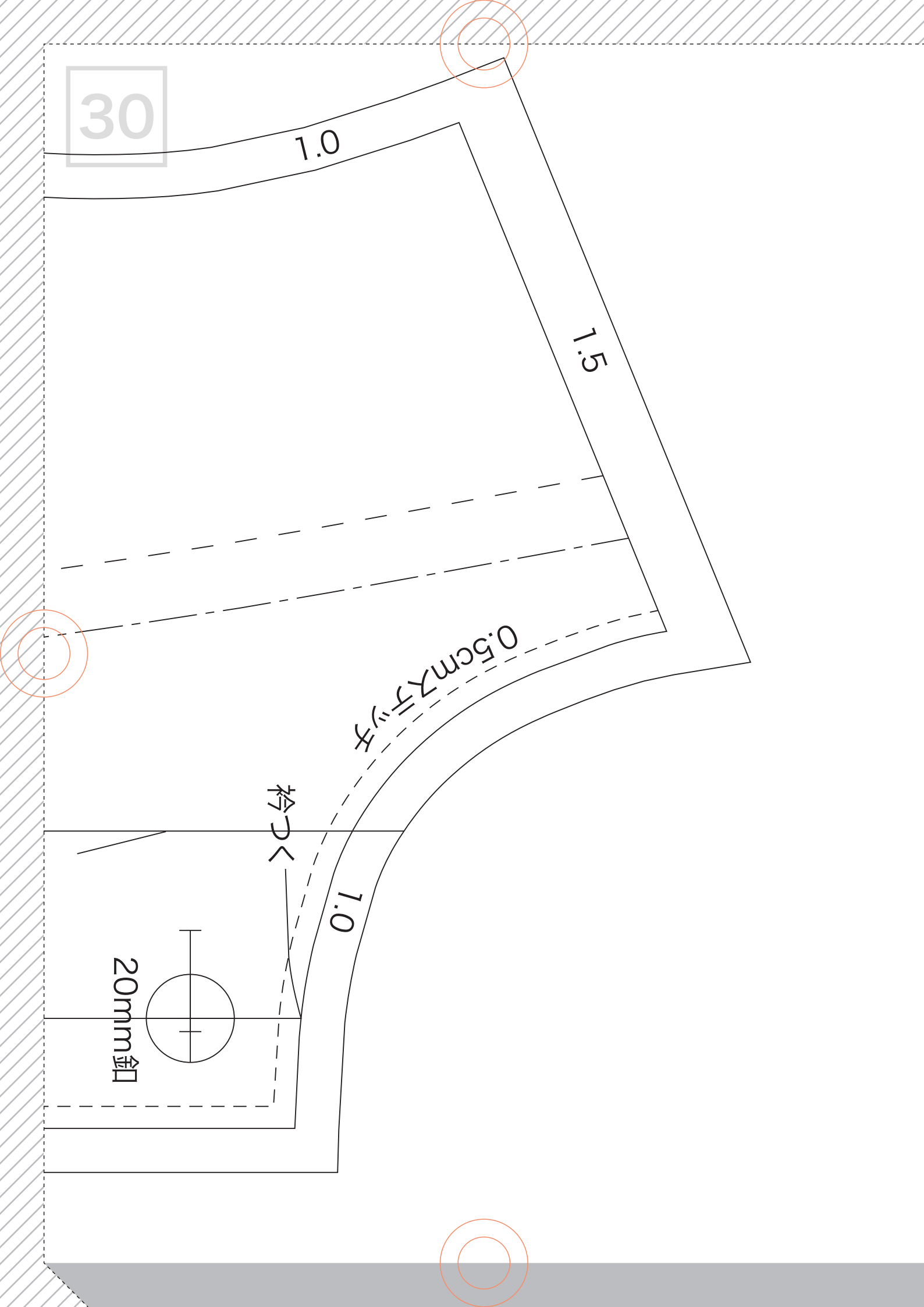

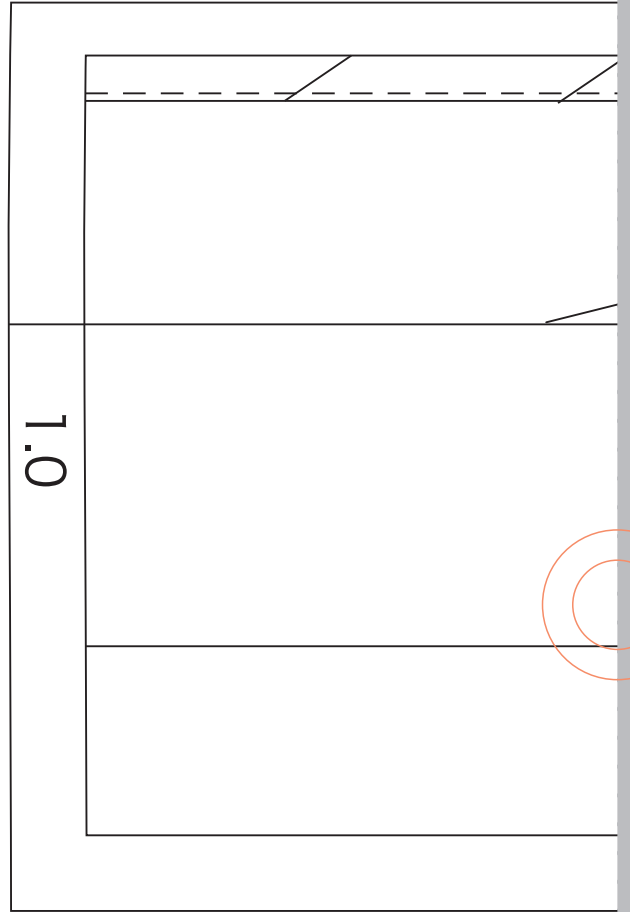
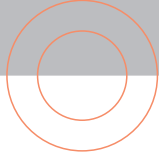

32

6mm/「イ」カヌ子-「フ」始末

33

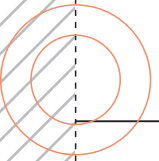
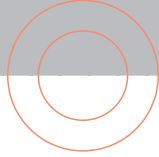

34

0.7

1.0

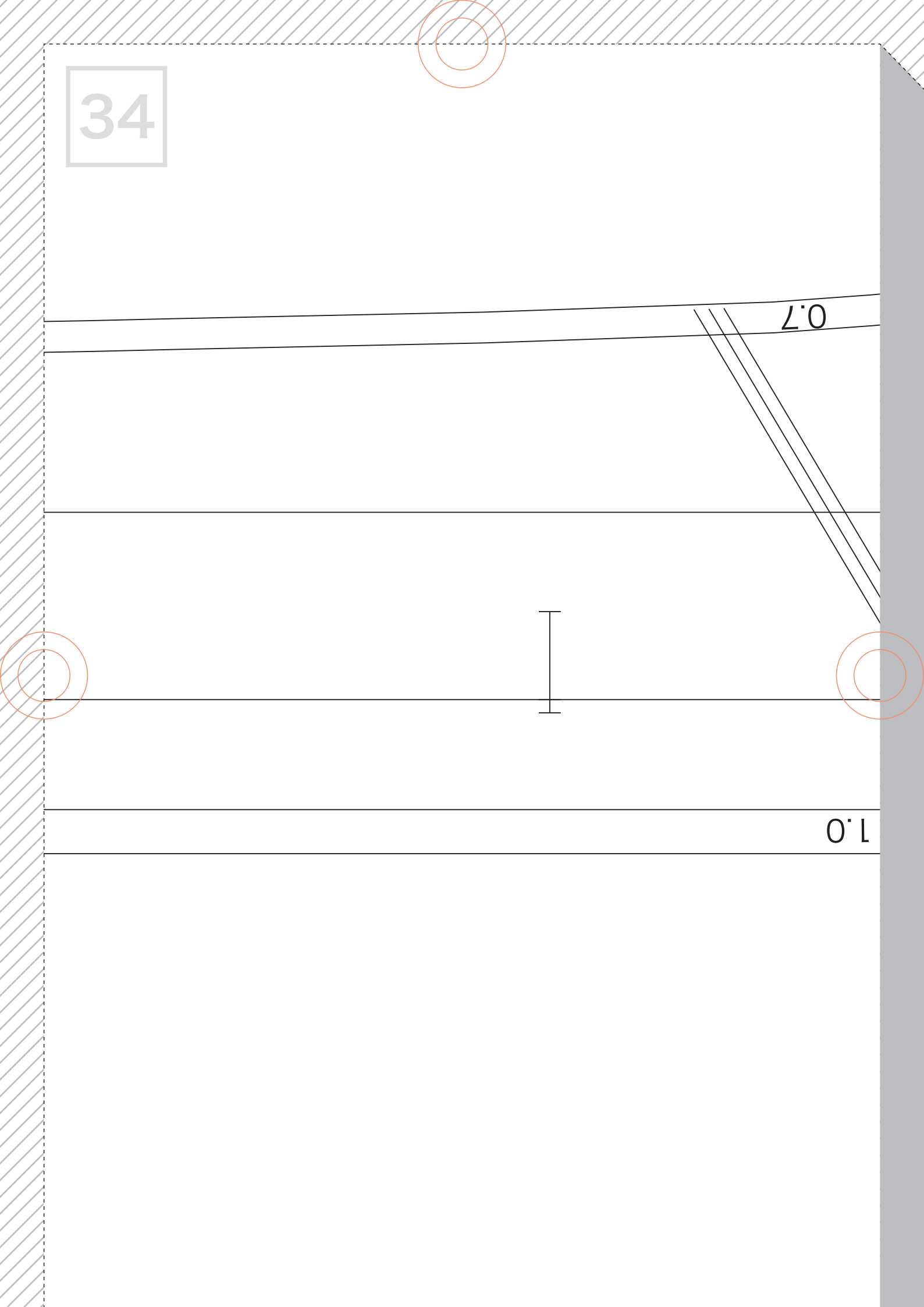

35

fabfab-13

前見返し

size : 13

表×2枚

芯×2枚

F・C

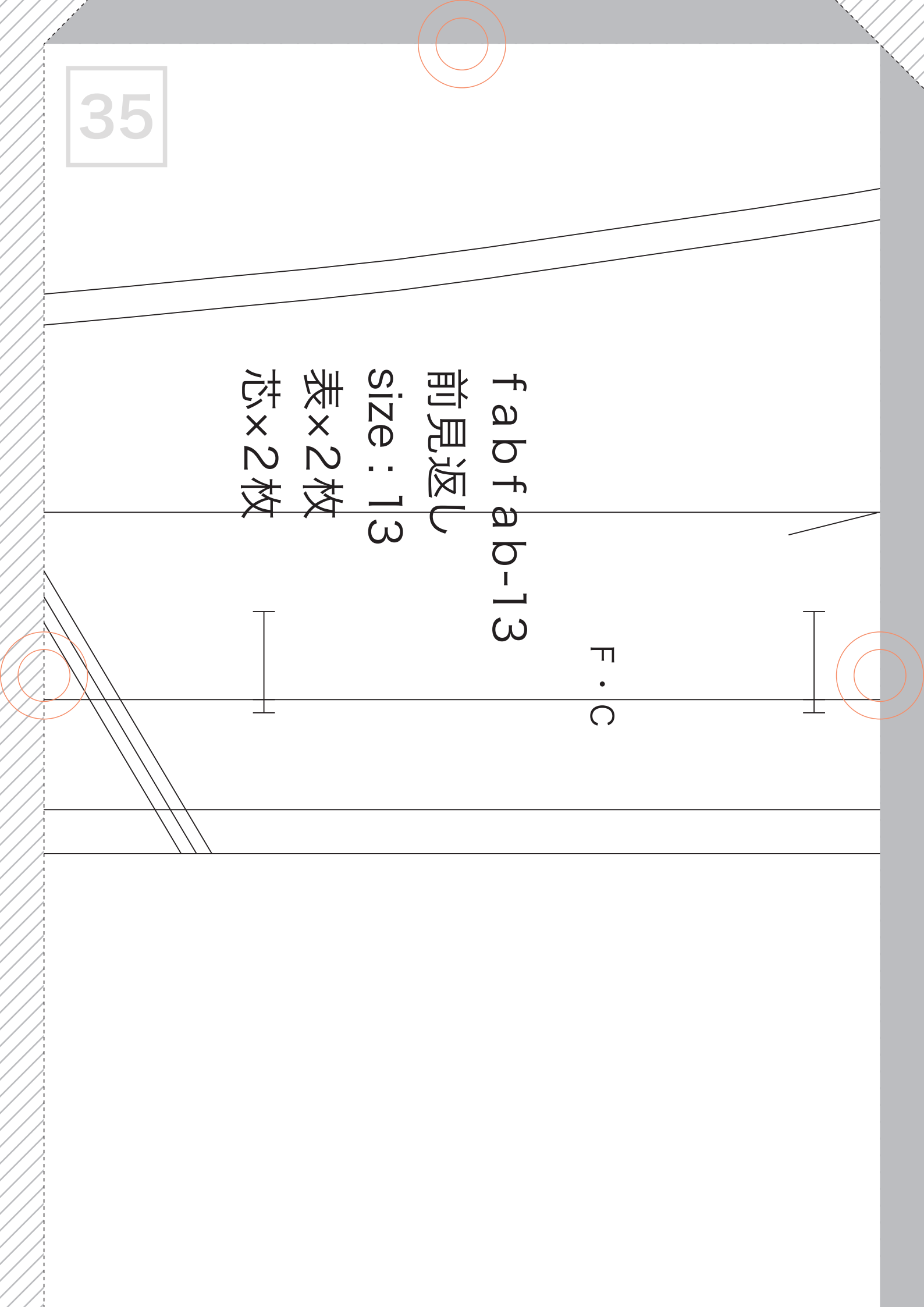

36

1:0

1:0

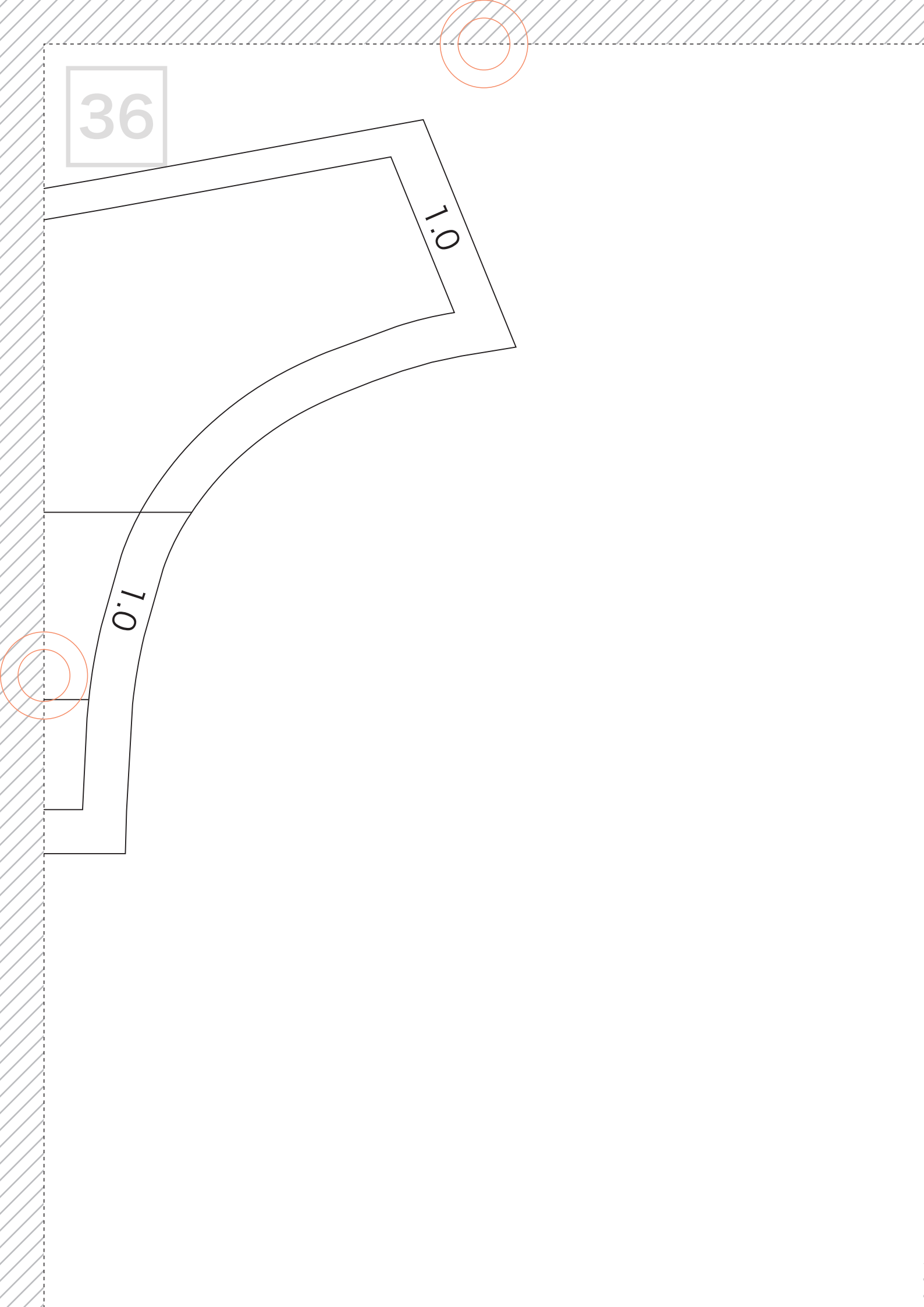
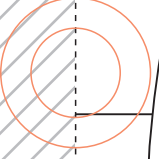
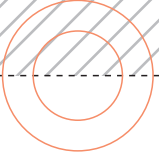

37

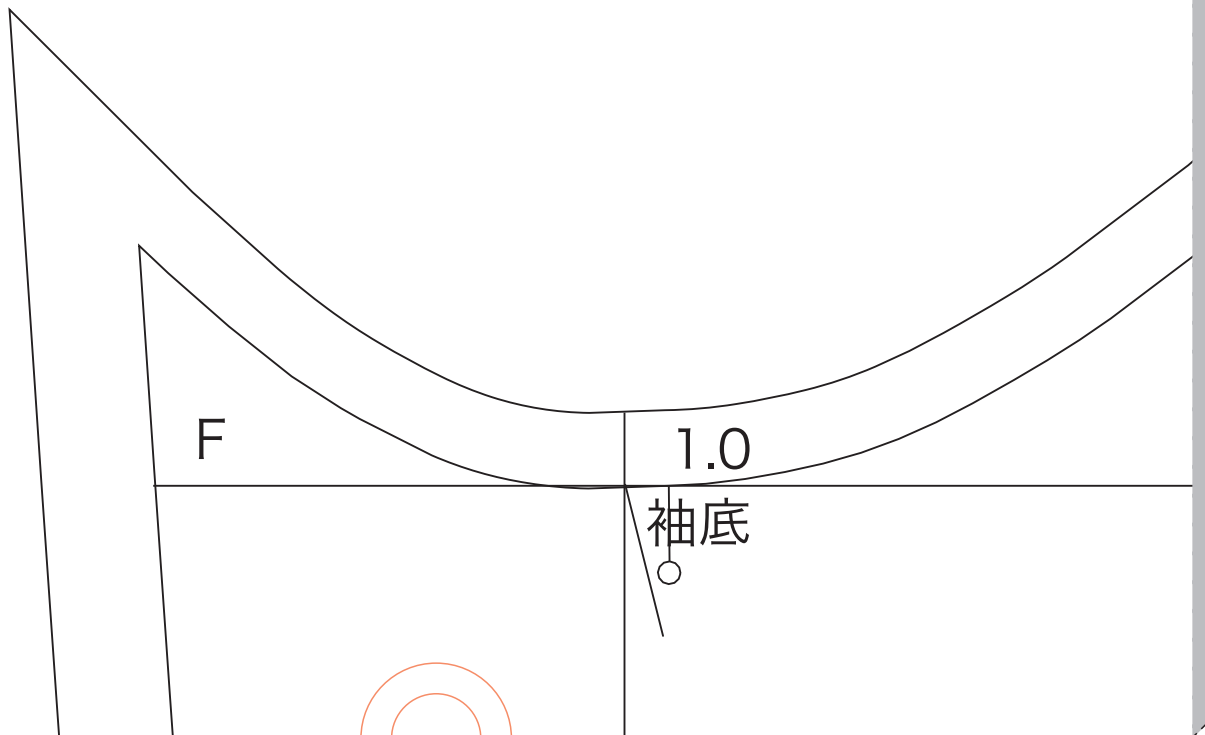

切り取る (斜線部はカット)

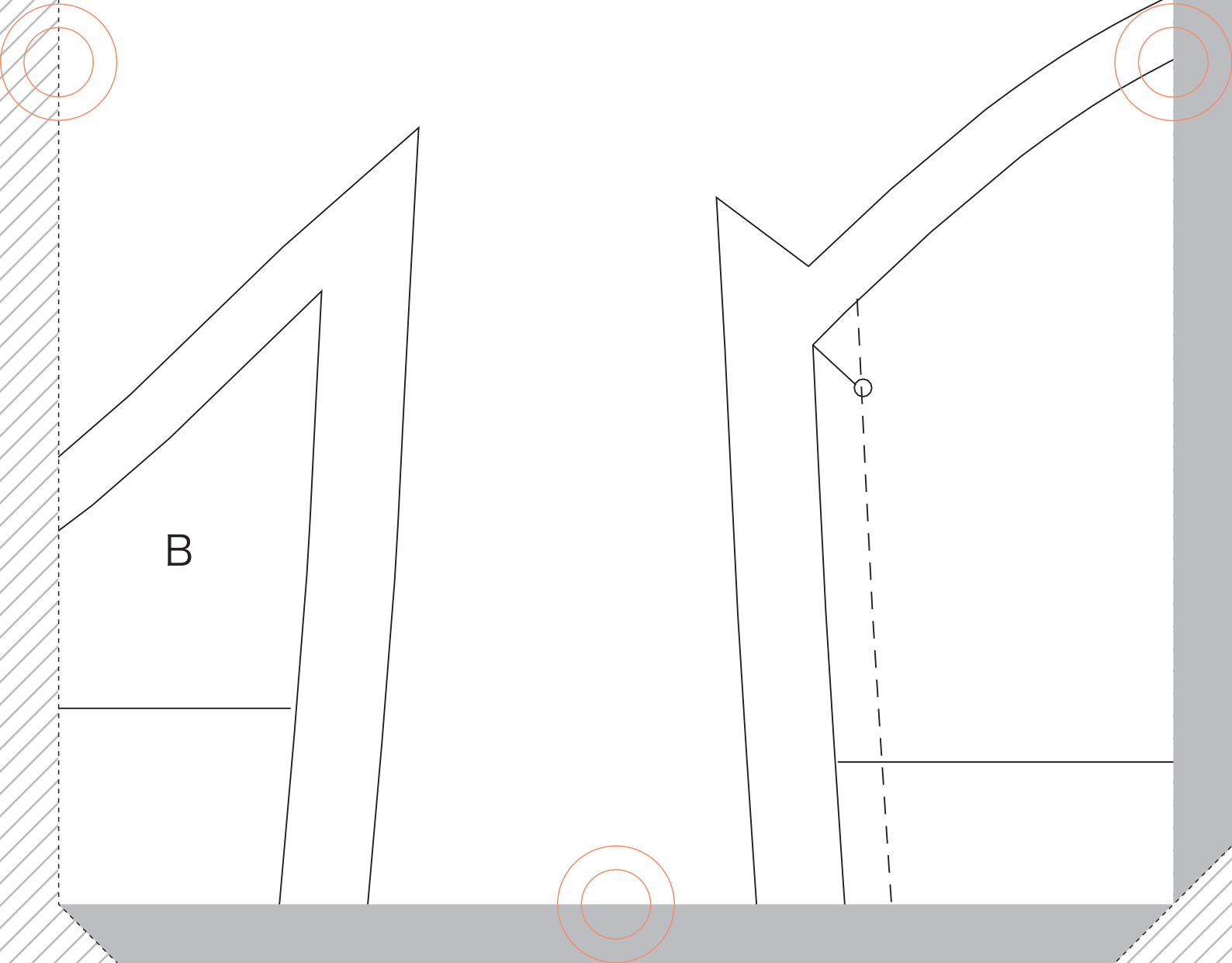

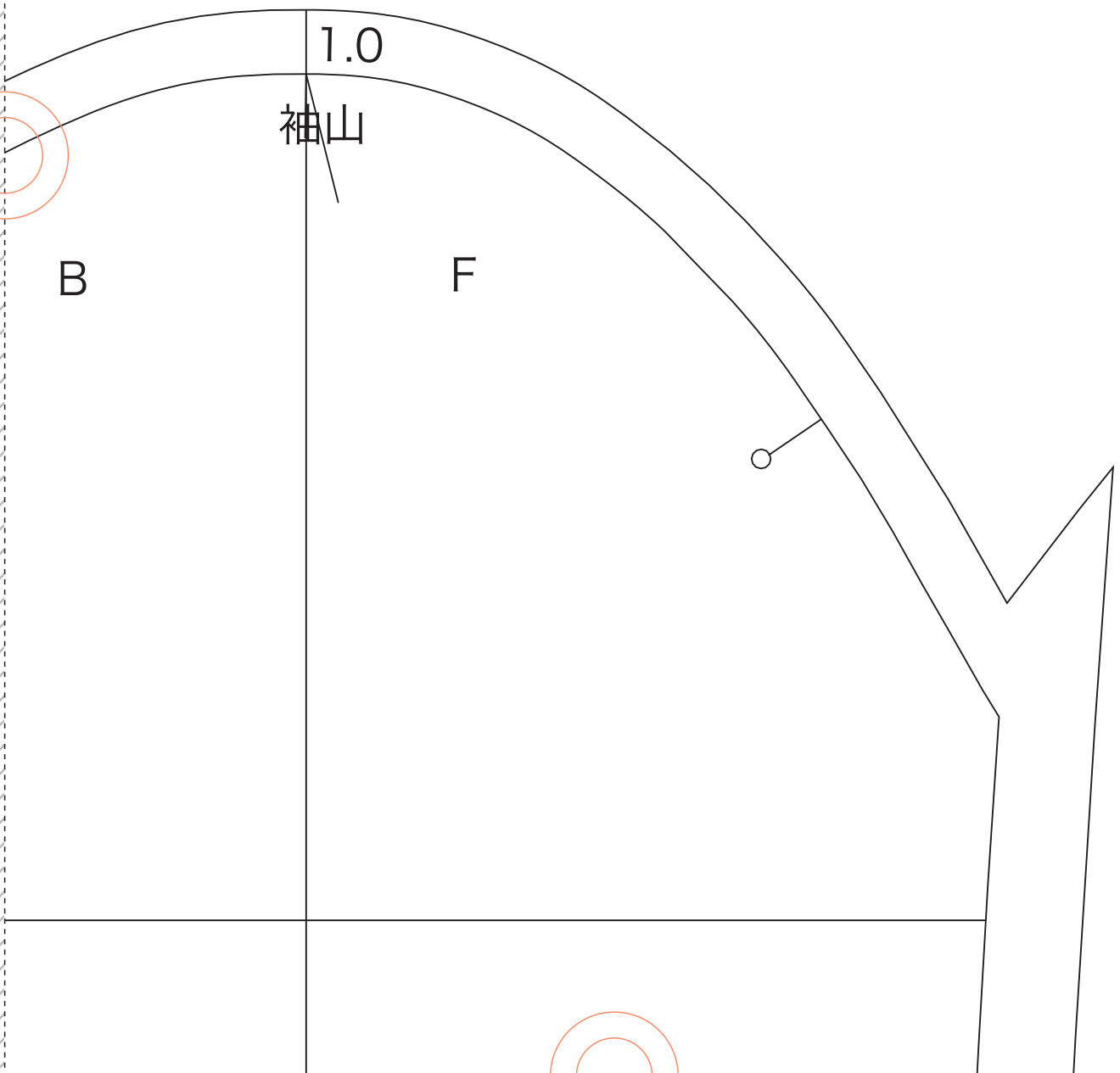

40

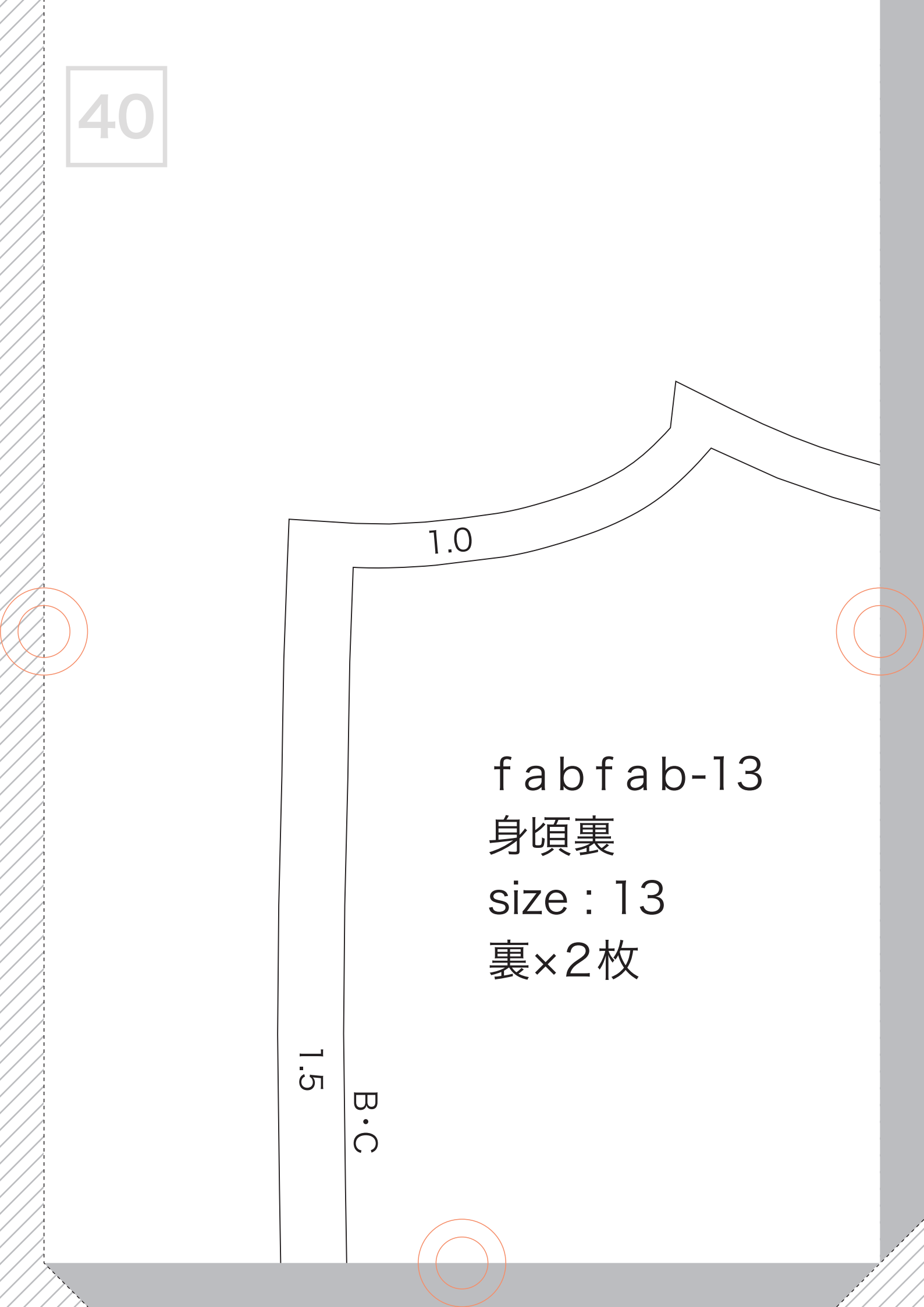

f a b f a b-13

身頃裏

size : 13

裏×2枚

41

1.0

1.0

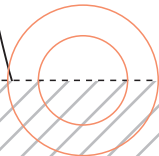
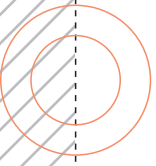

42

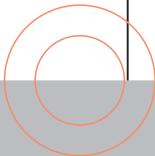
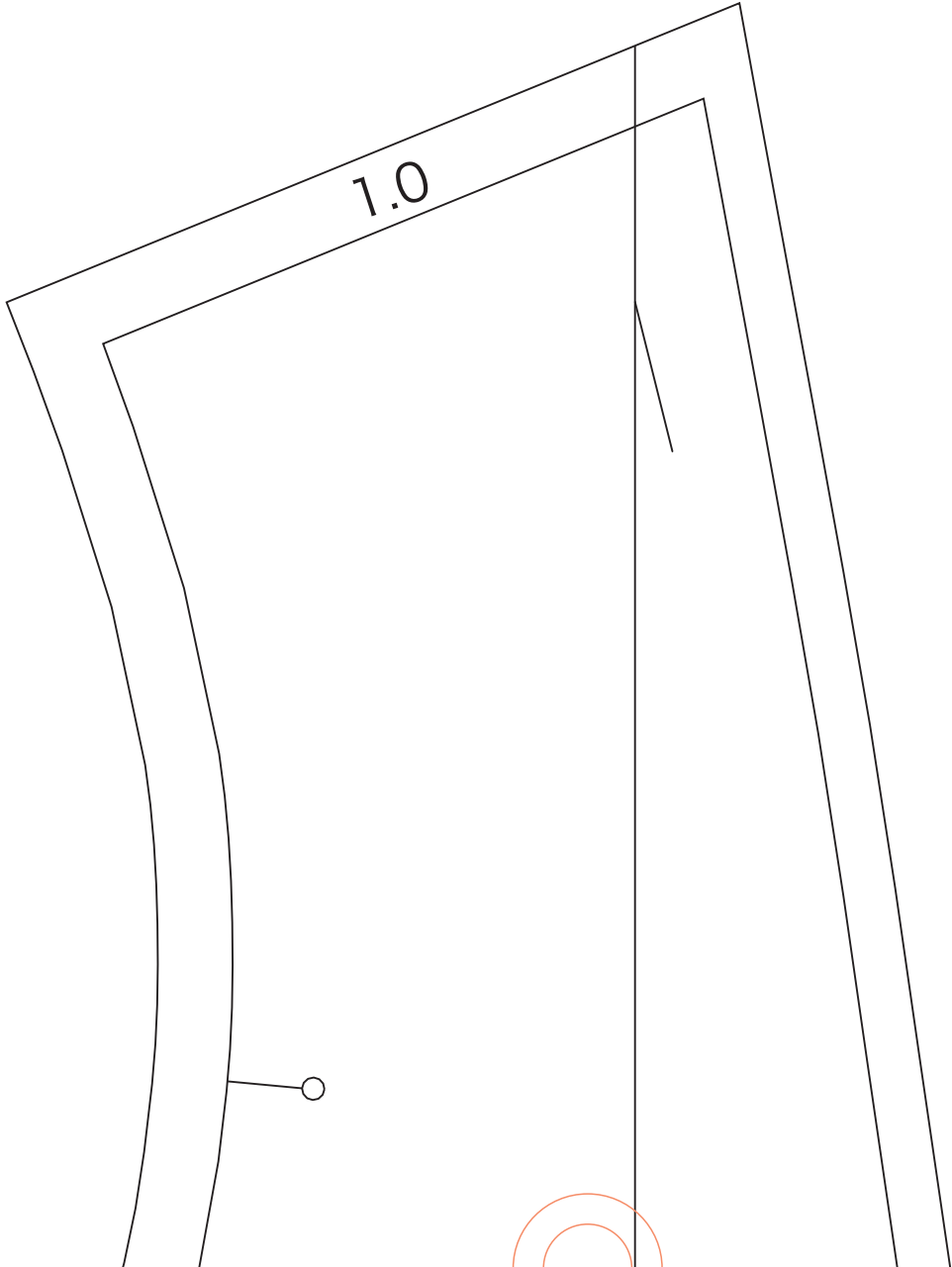
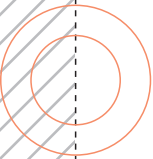

43

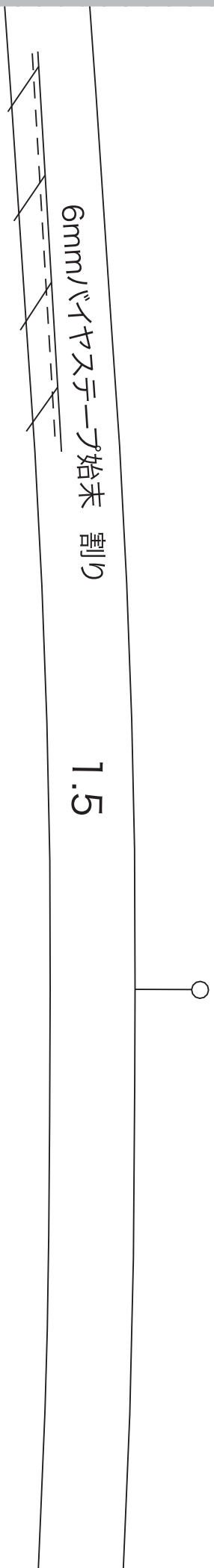

fabfab-13

内袖

size : 13

表×2枚

44

1.5

折り伏せ始末

1.5

折り伏せ始末

0.8cmステッチ

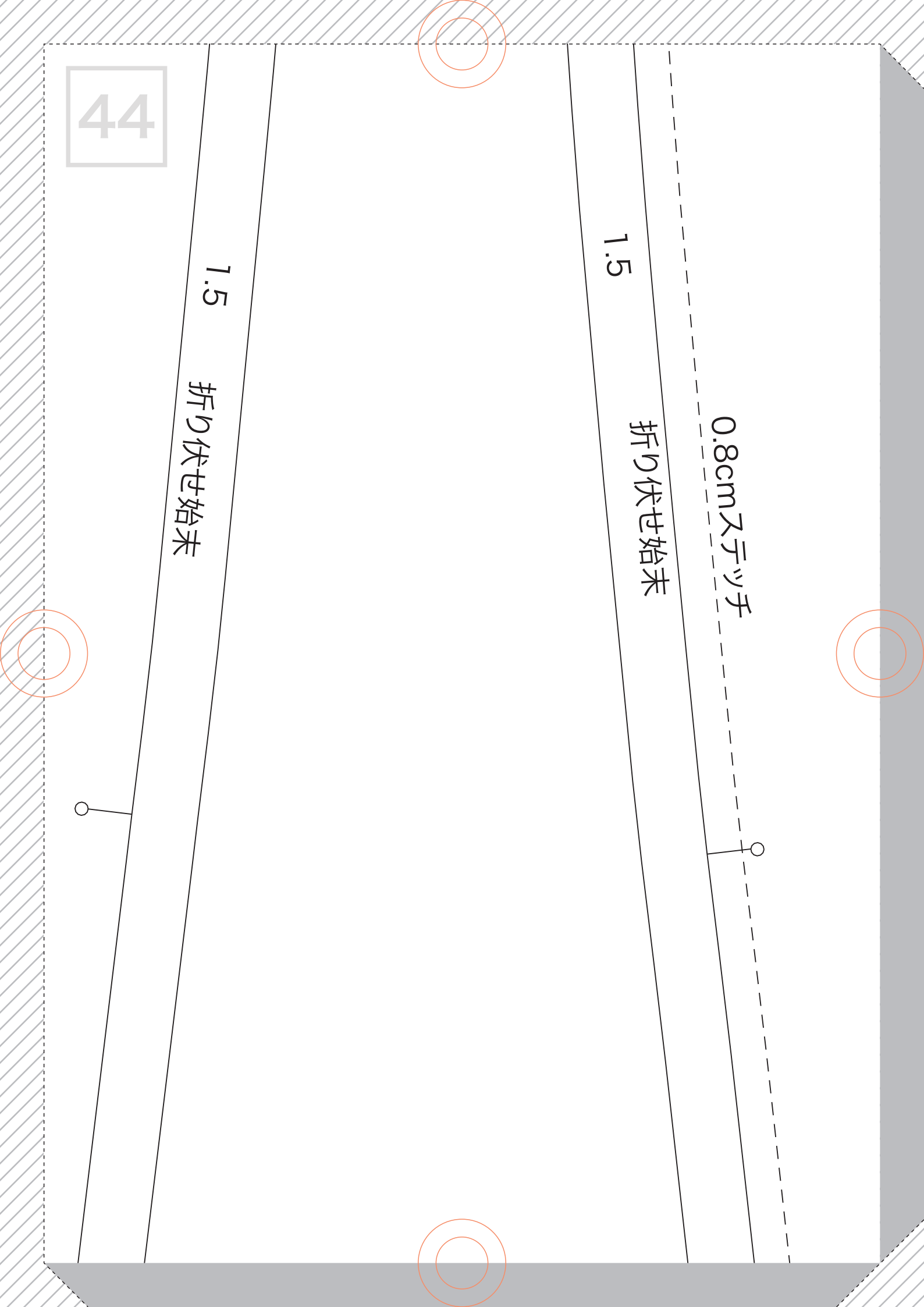

45

f a b f a b-13

外袖

size : 13

表×2枚

6mmバイヤステニー
プ始め 割り

1.5

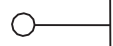

46

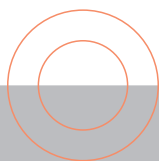
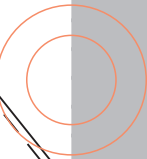
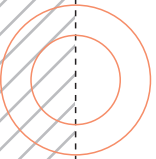
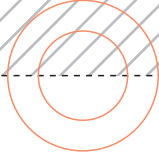

0

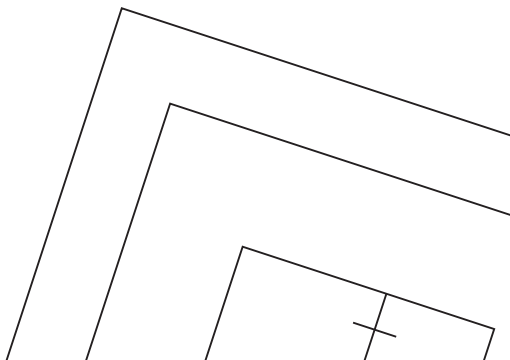

47

B

袖底

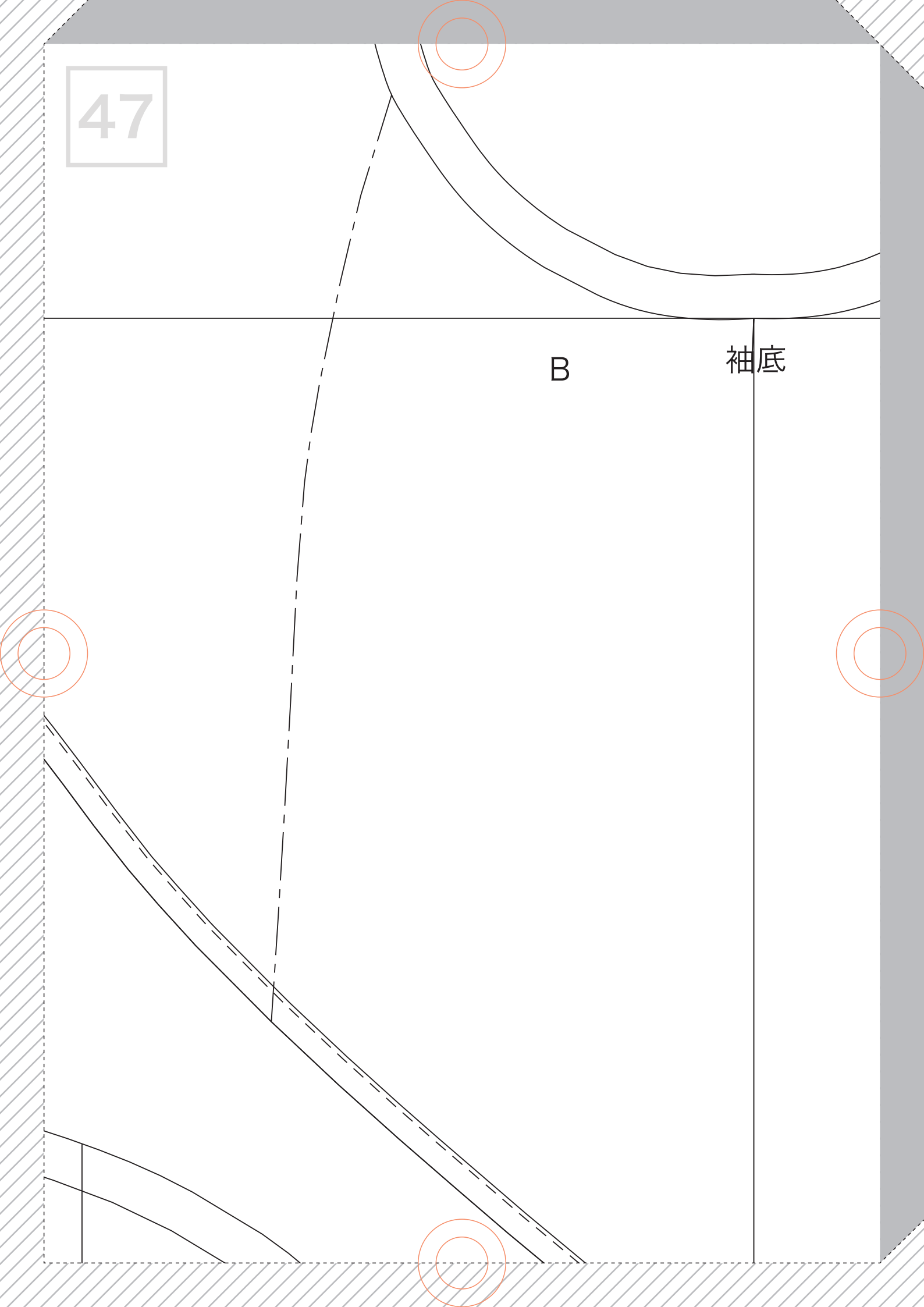

48

F

0.7

前見返しとはぐ

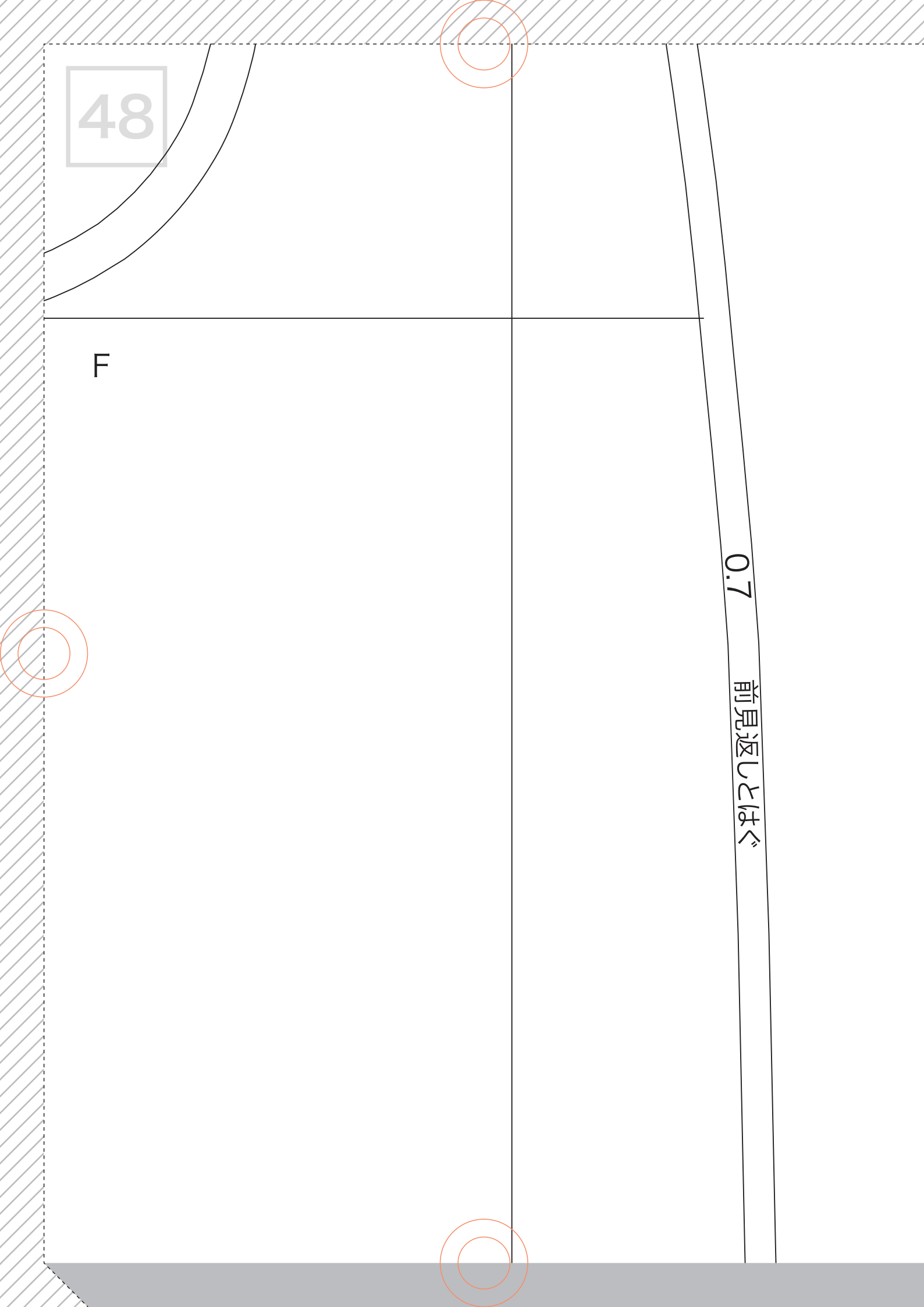

49

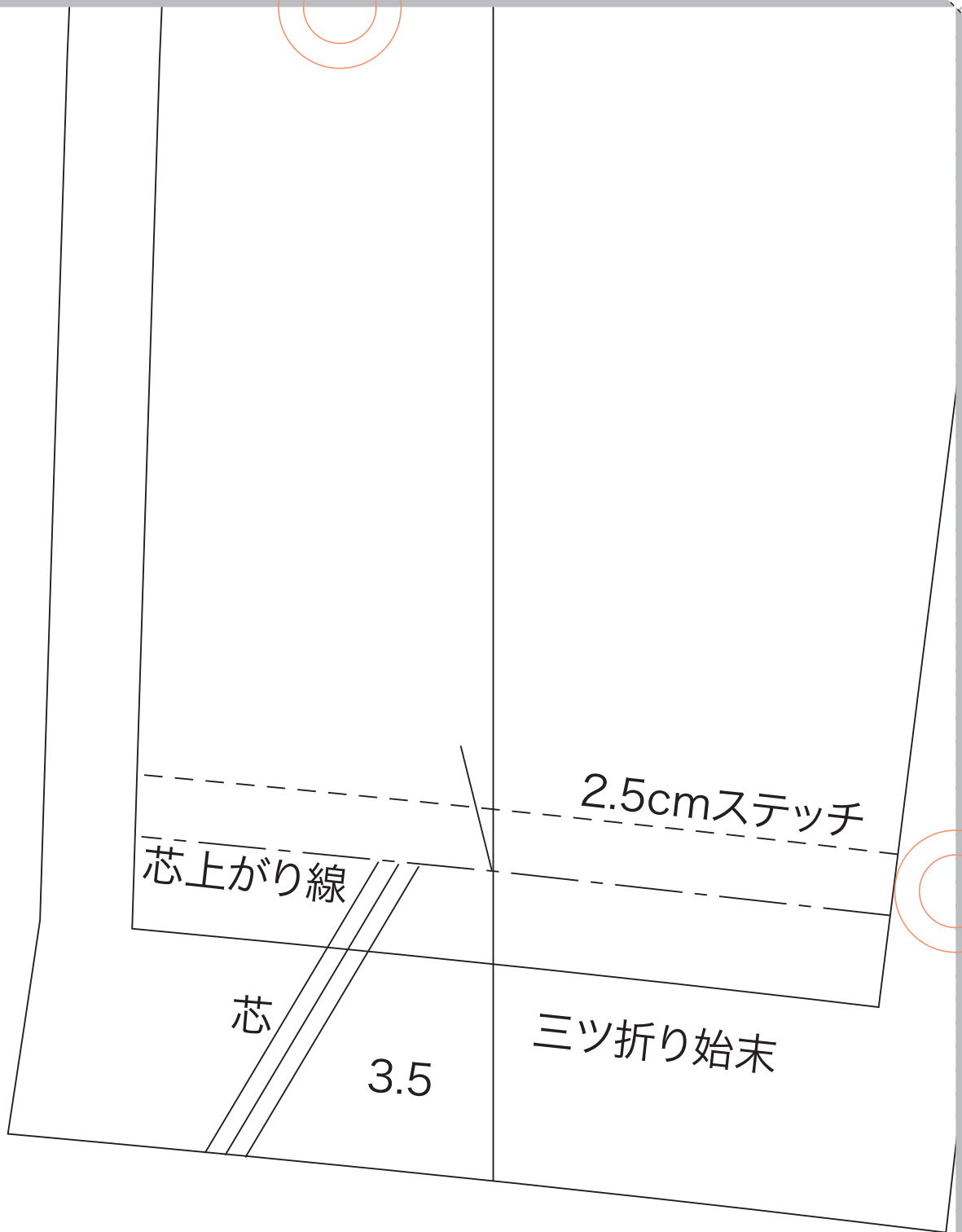

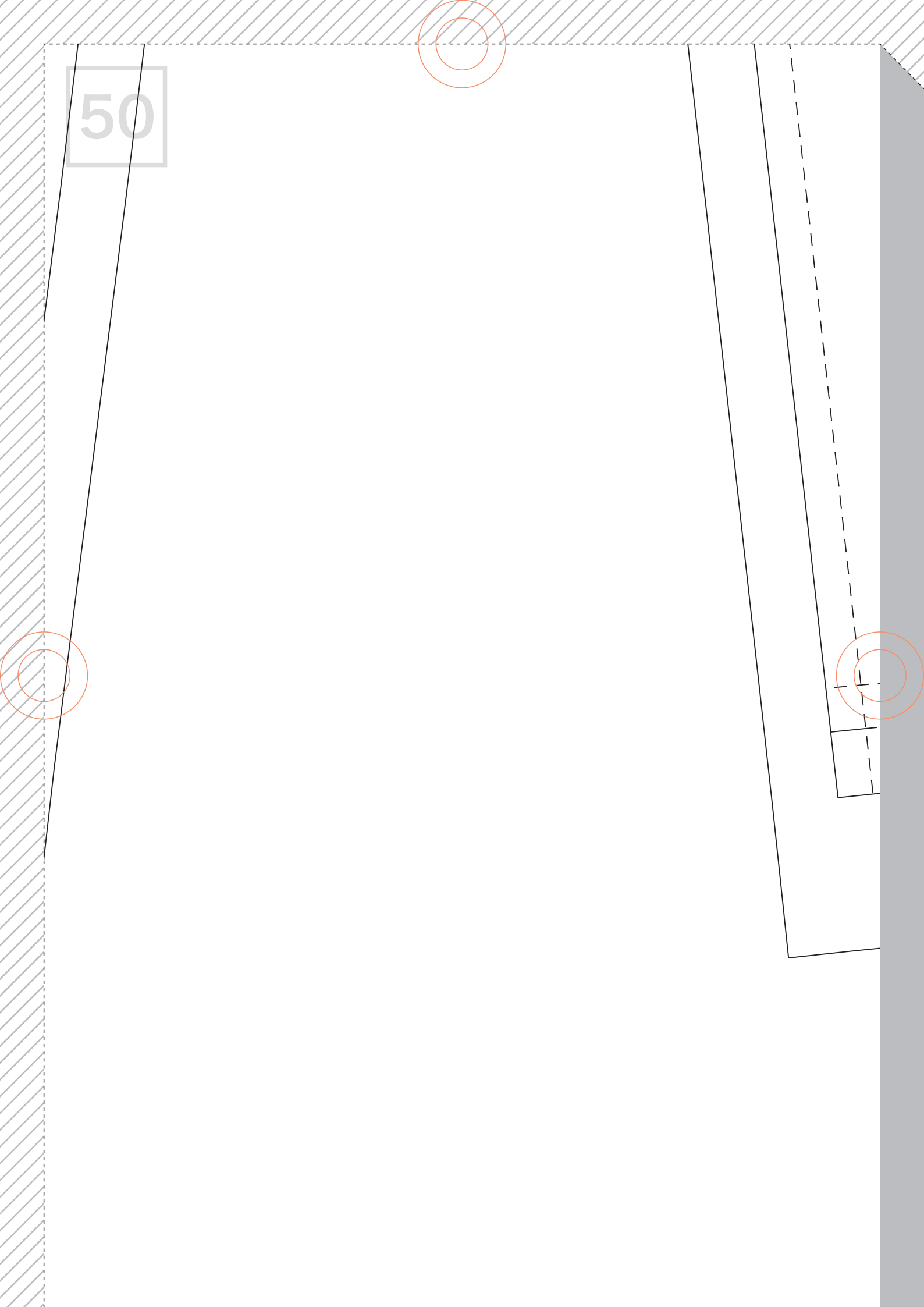

50

51

2.5cmステッチ

芯上がり線

三ツ折り始末

3.5

芯

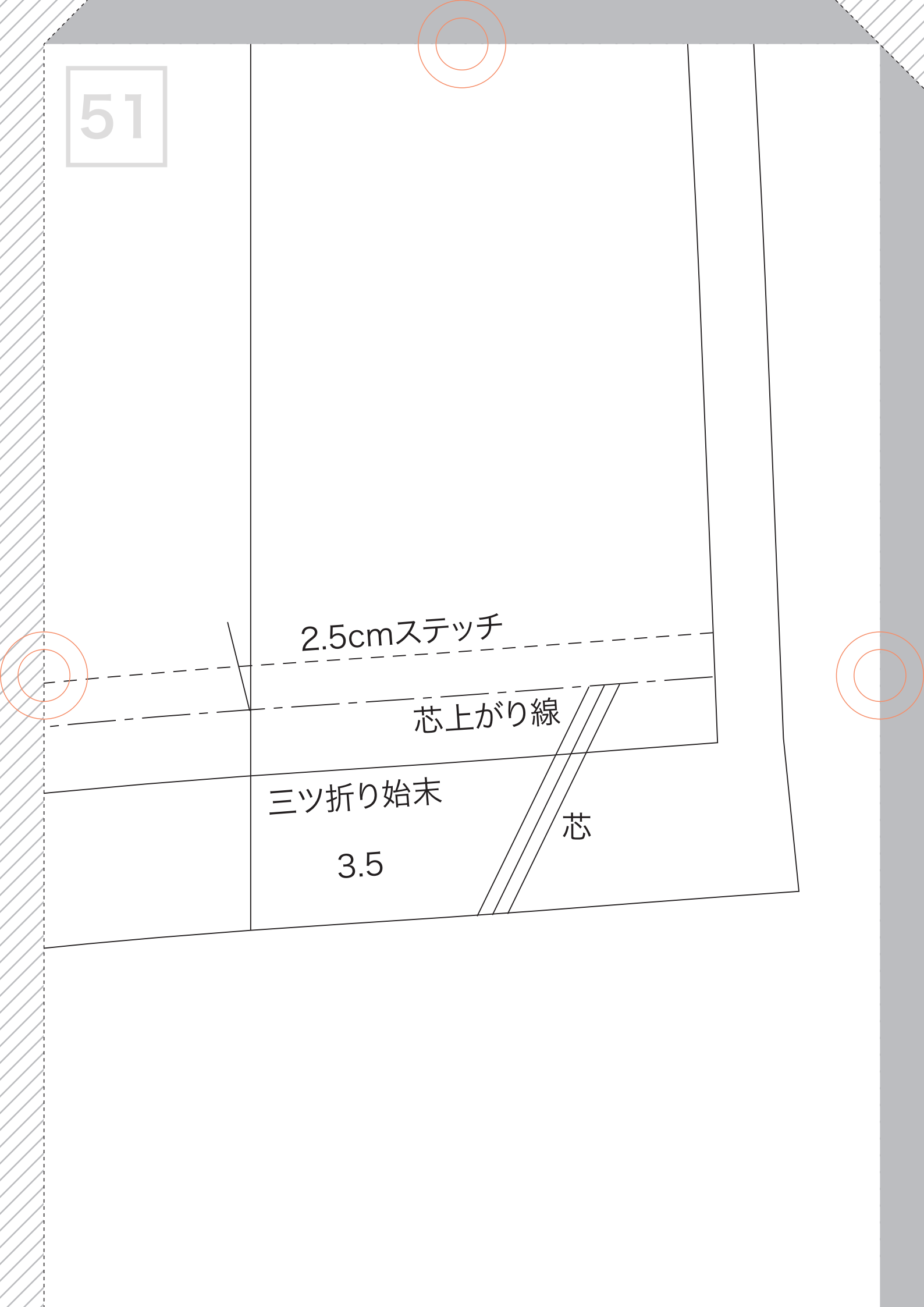

52

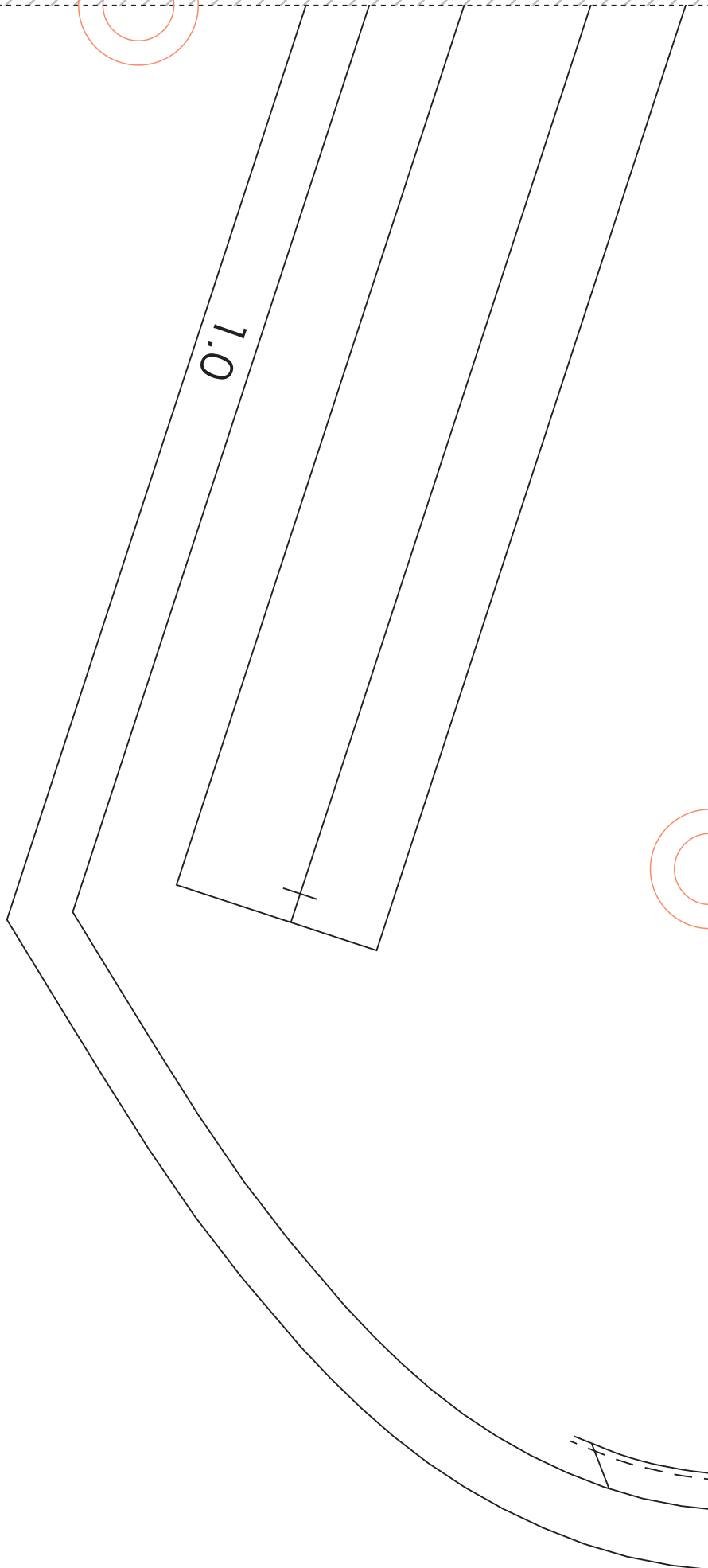
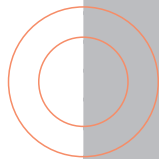
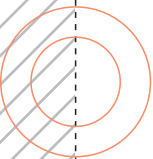
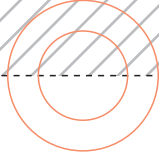

53

f a b f a b-13
箱ポケット袋布
size : 13
表×4枚

6mmバイヤステーブ始末

1.0

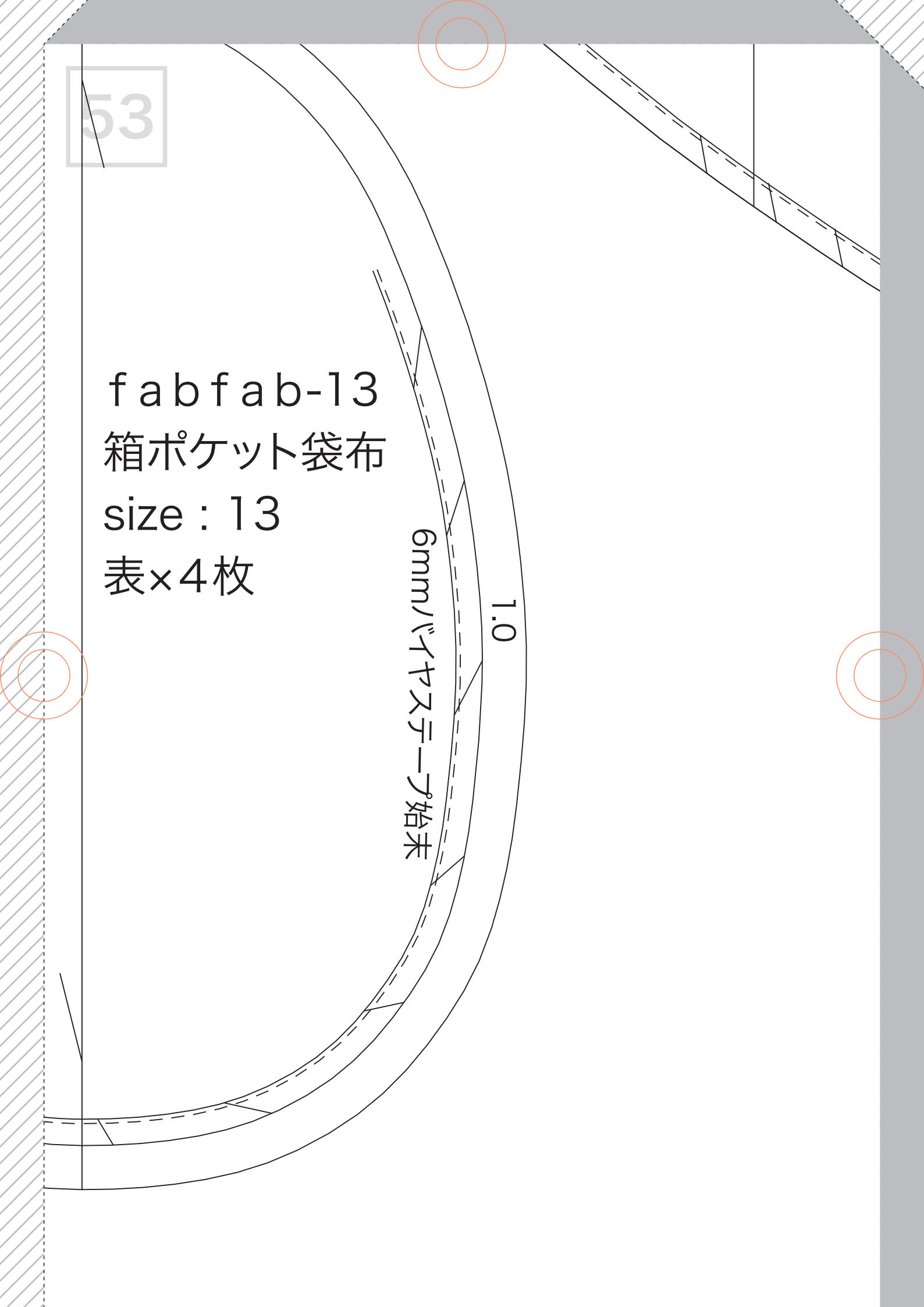

54

6mmバイヤステープ始末

