



introduction はじめに

パターンは A4 サイズ 54 枚に分割されています。
印刷後、右図のようにつなぎ合わせてください。

! 印刷時の注意

印刷設定では、「ページの拡大や縮小」を選択せず
必ず、「実際のサイズ」(原寸) で印刷してください。

how to make パターンのつくりかた

STEP1 斜線部分  は切り取り、灰色部分  は残してのりしろにします。
(斜線と灰色を間違えないように注意)

STEP2 各用紙の番号を確認し、 の位置を合わせて、のりづけします。
(水のりは用紙が波打ちます。スティック糊などをお使いください)

STEP3 それぞれのパーツをハサミで切り出します。

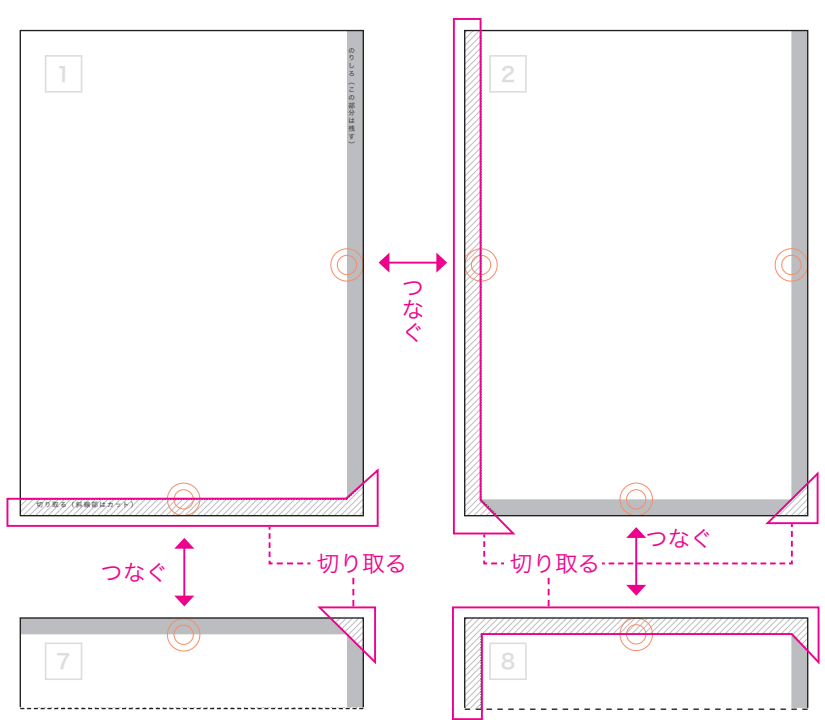
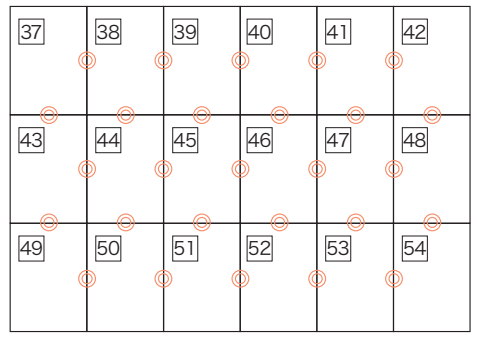
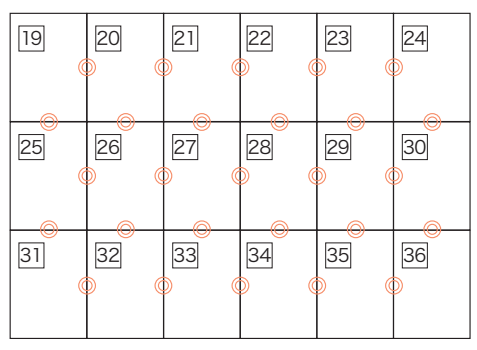
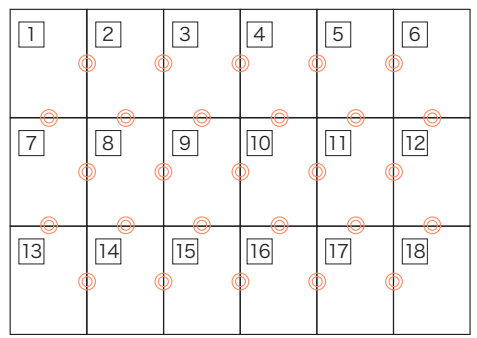

のりしろ (この部分は残す)

1

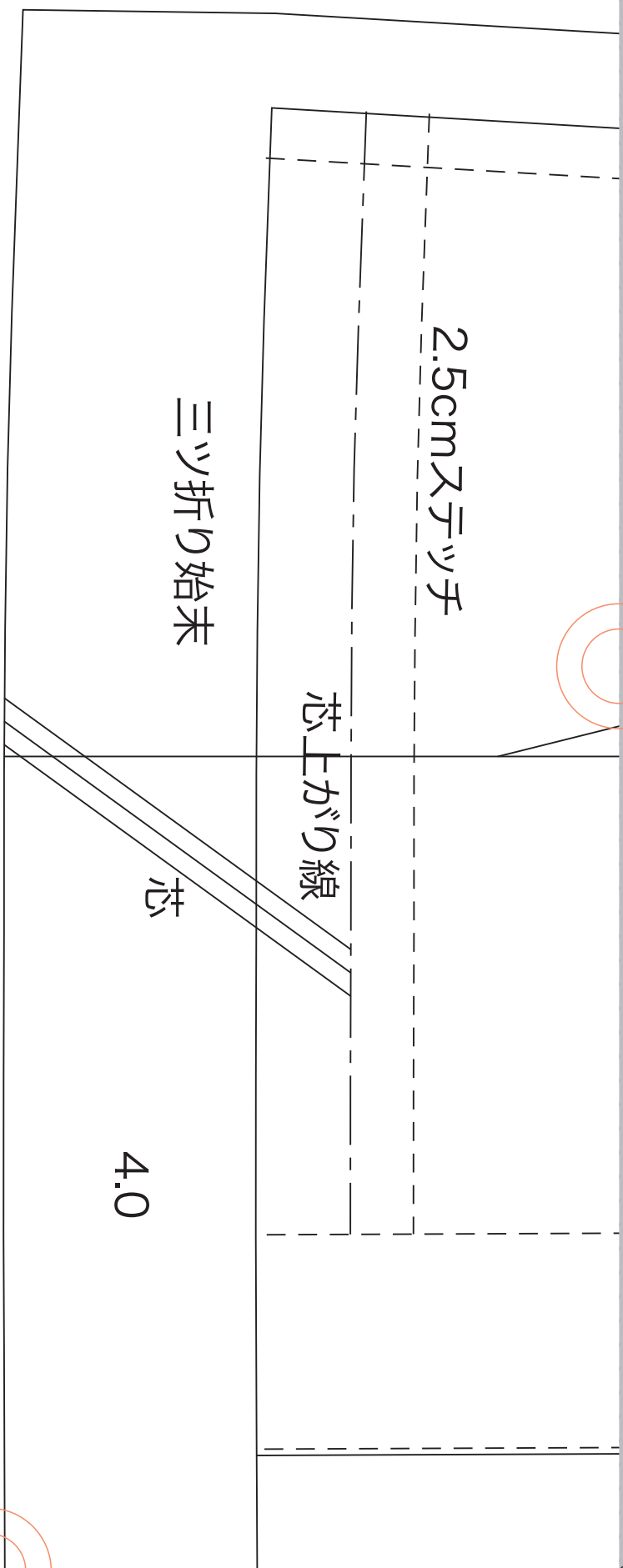

切り取る (斜線部はカット)

2

ベツ持ち出し押さえスツチ

枘

コバースツチ

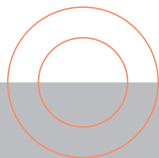
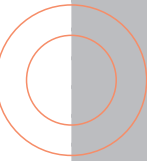
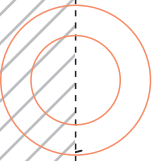

3

折り伏せ始末

0.8cm入ツチ

折る

1.0

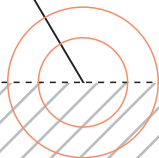
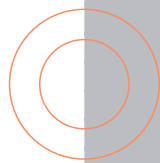
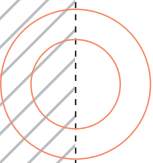

4

1.5

裏地上がり線

折り伏せ始末

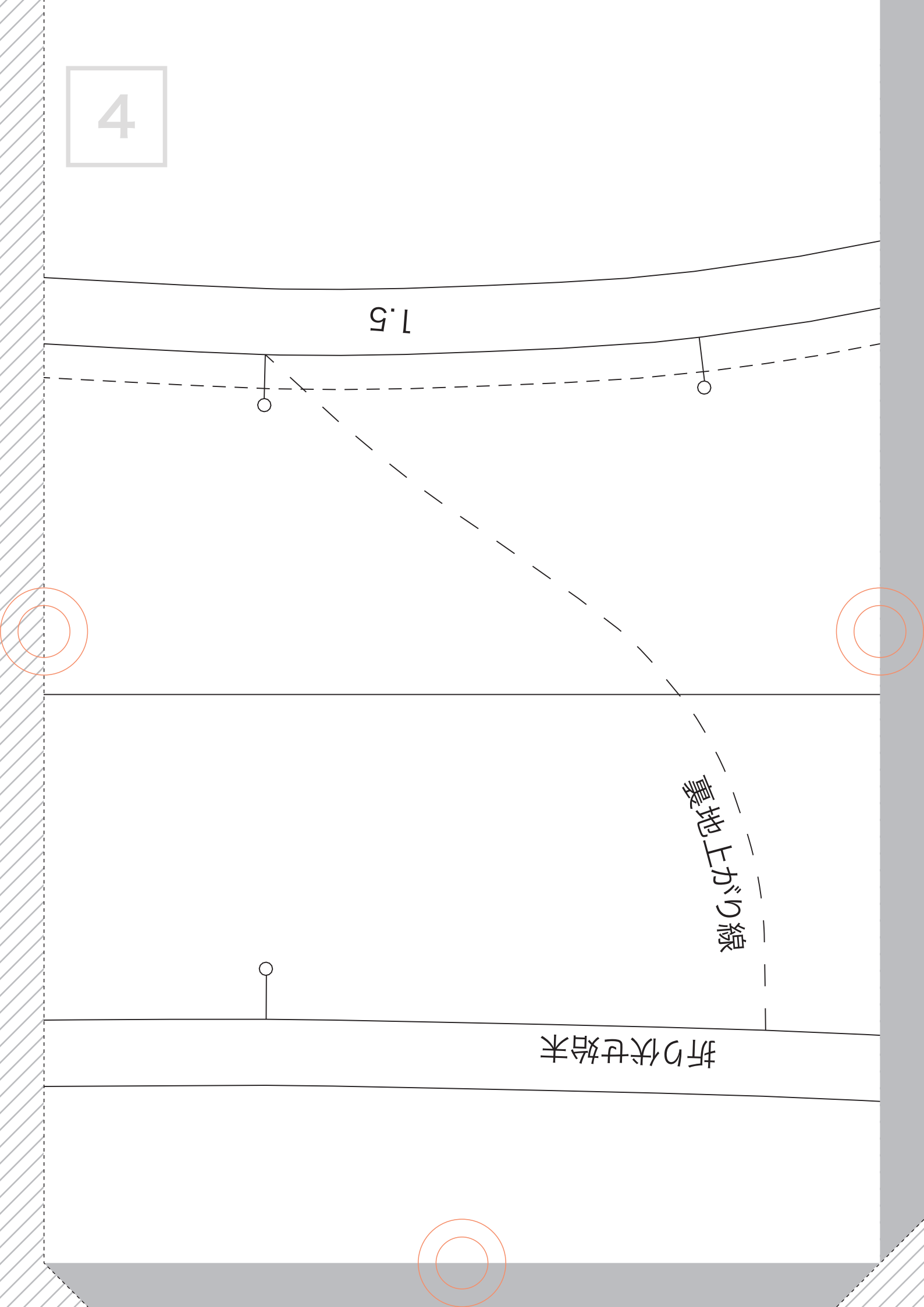
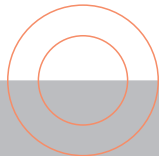
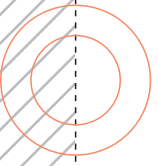

5

1.0

f a b f a b - 1 3
左後身頃
size : 7
表 × 1 枚

B · C

1.5

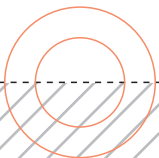
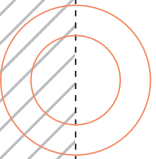

6

折り伏せ始末
1.5
0.8cmヌテツチ

1.0
0.5cmヌテツチ

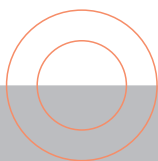

7

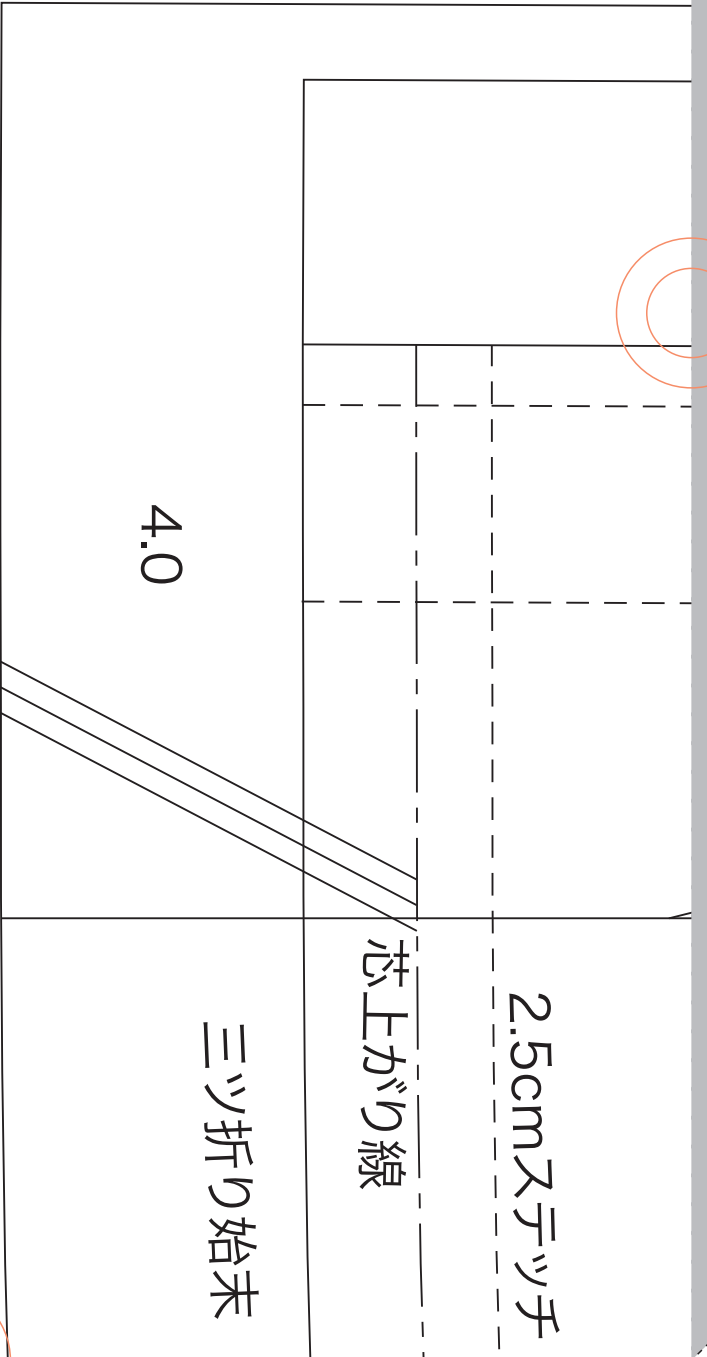
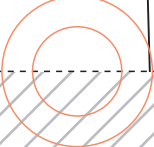
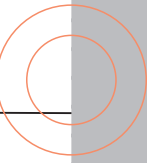
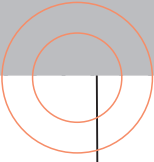

4.0

2.5cm ステッチ

芯上がり線

ミツ折り始末

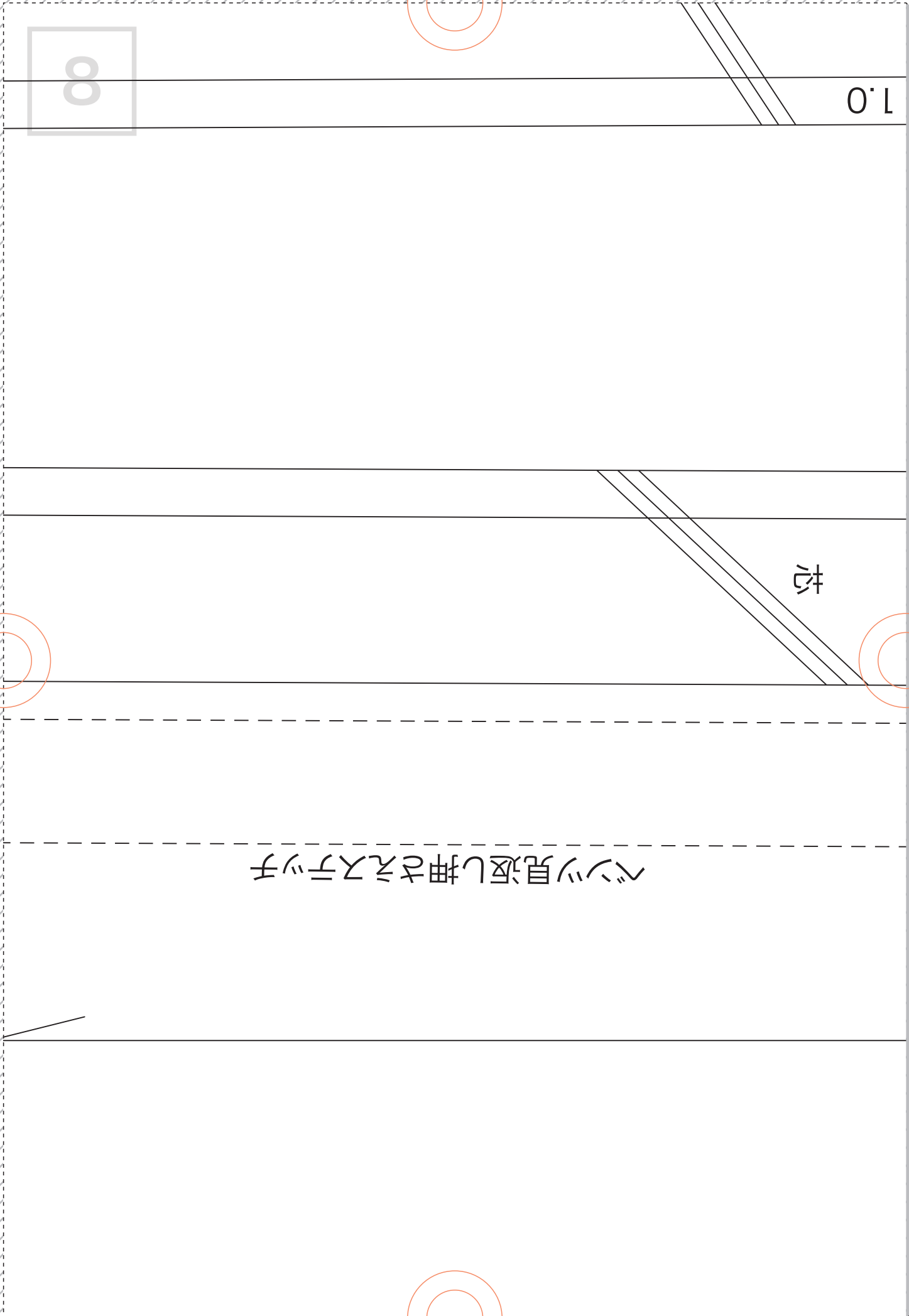

8

1.0

松

ベツ見返し押さえテッチ

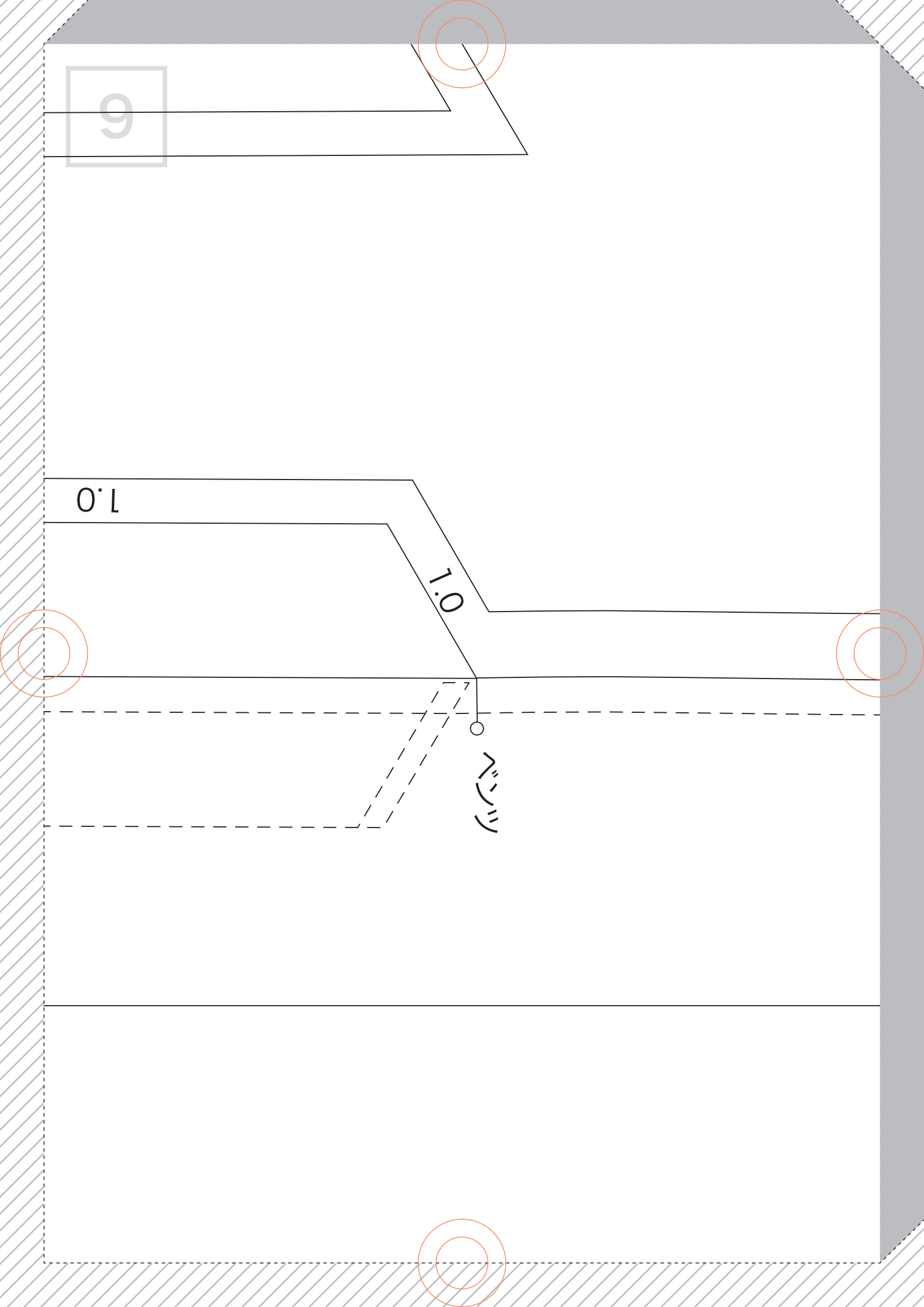

10

折り伏せ始末

裏地上がり線

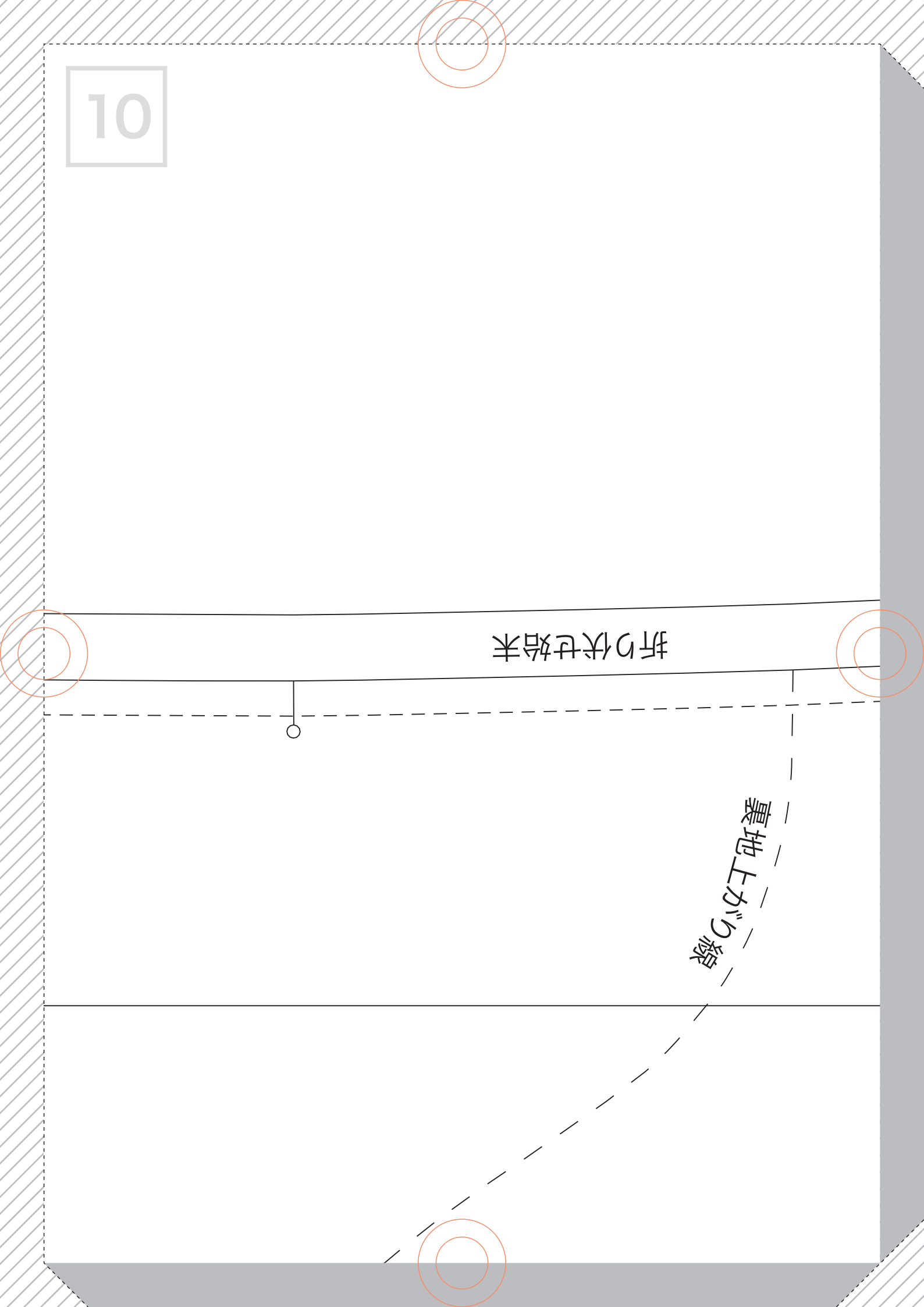

11

1.5

B.C

0.8cmアツキ

fabfab-13
右後身頃
size : 7
表×1枚

12

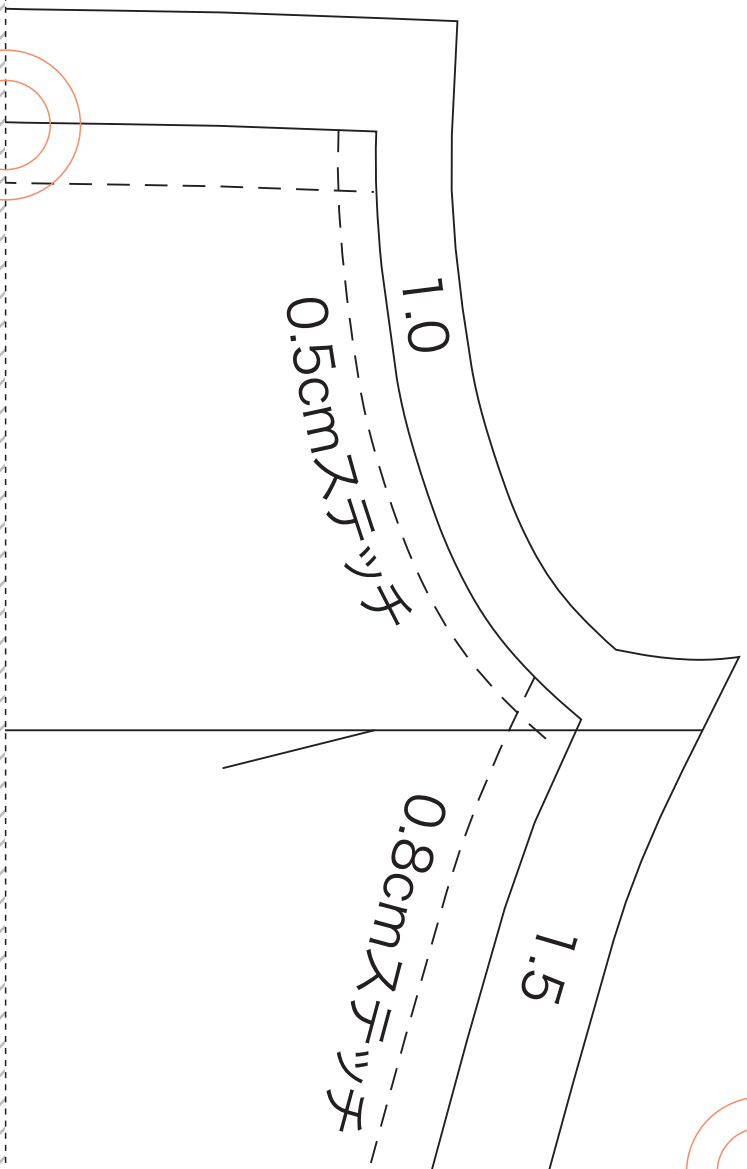
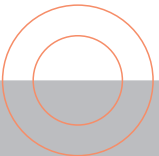
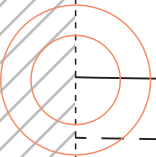
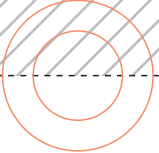

13

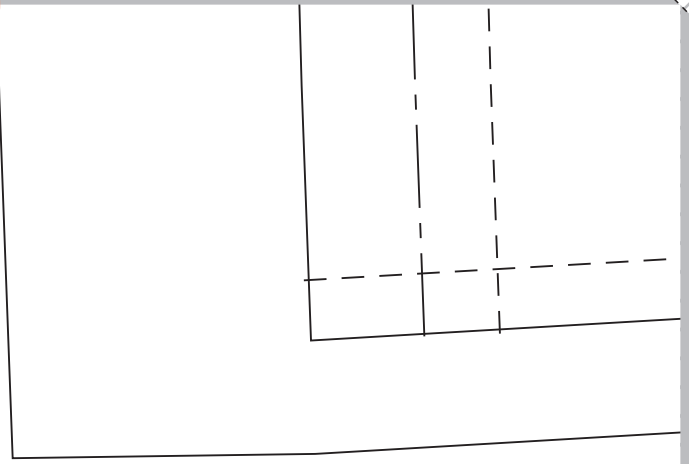
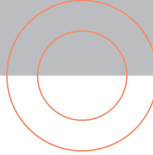

14

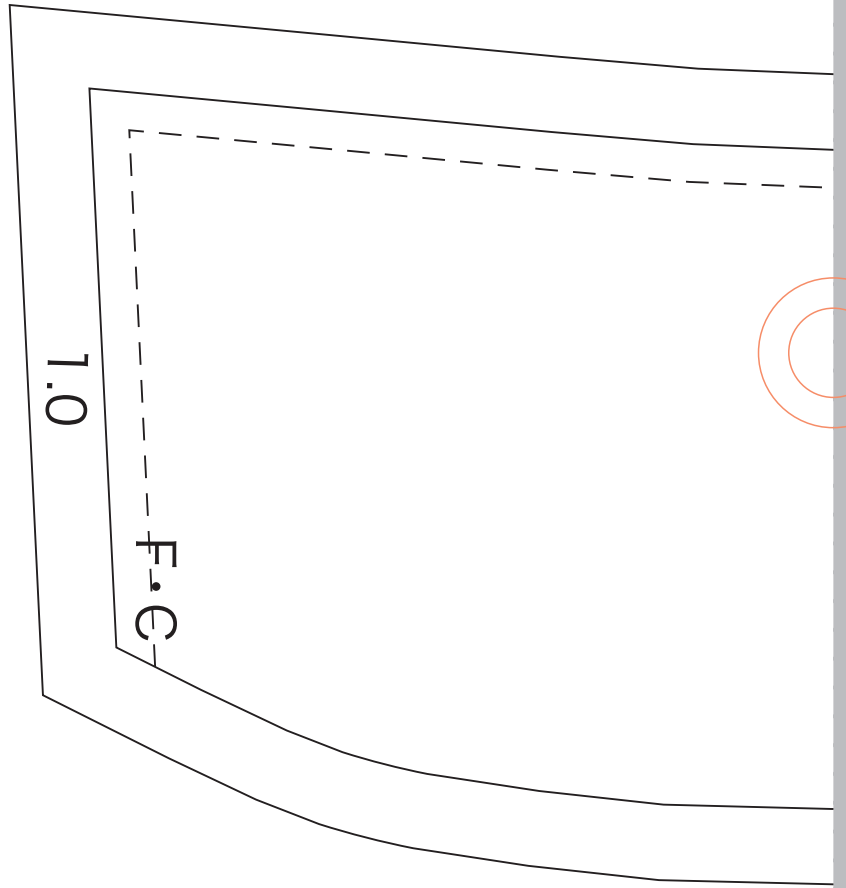
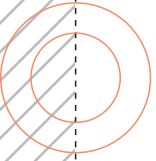
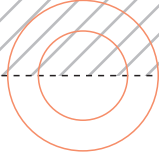

0.8cmステッチ

折り伏せ始末

15

0.5cmステッチ

N · P

B · C

1.0

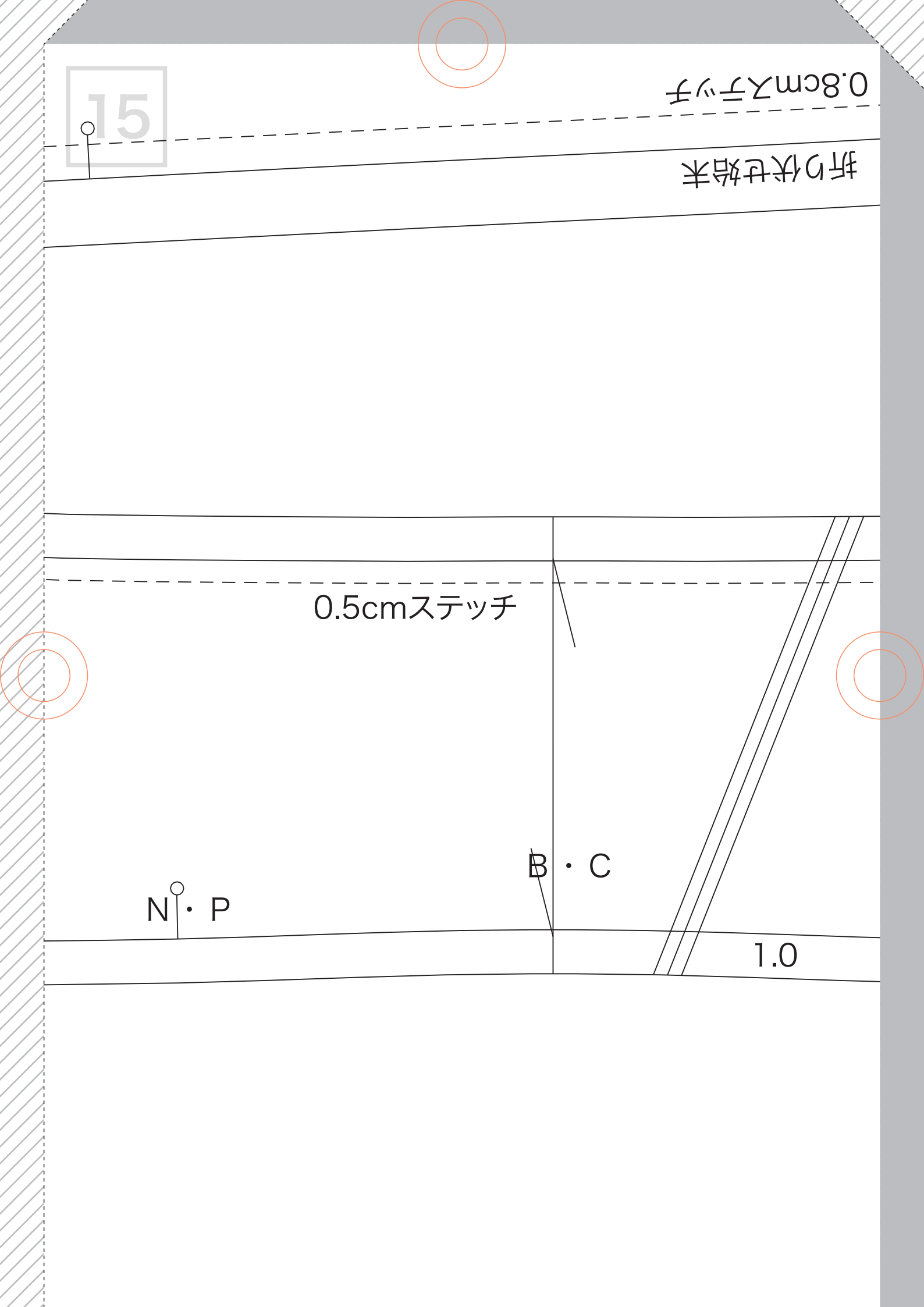

16

1.5

1.0

f a b f a b - 13

衿

size : 7

表 × 2 枚

芯 × 2 枚

F · C

1.0

N · P

17

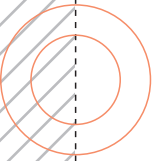
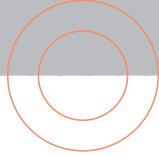
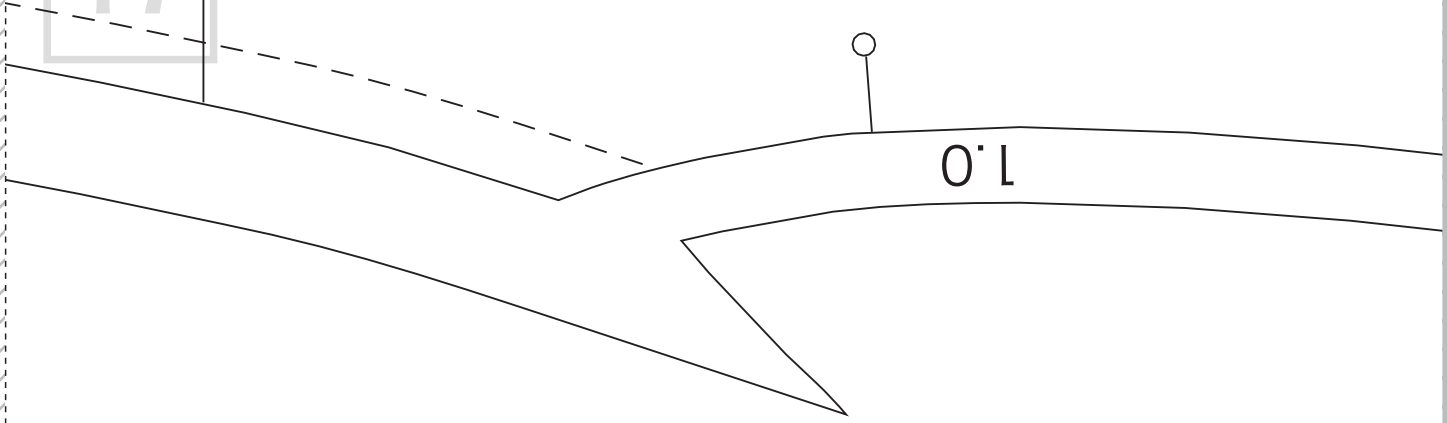

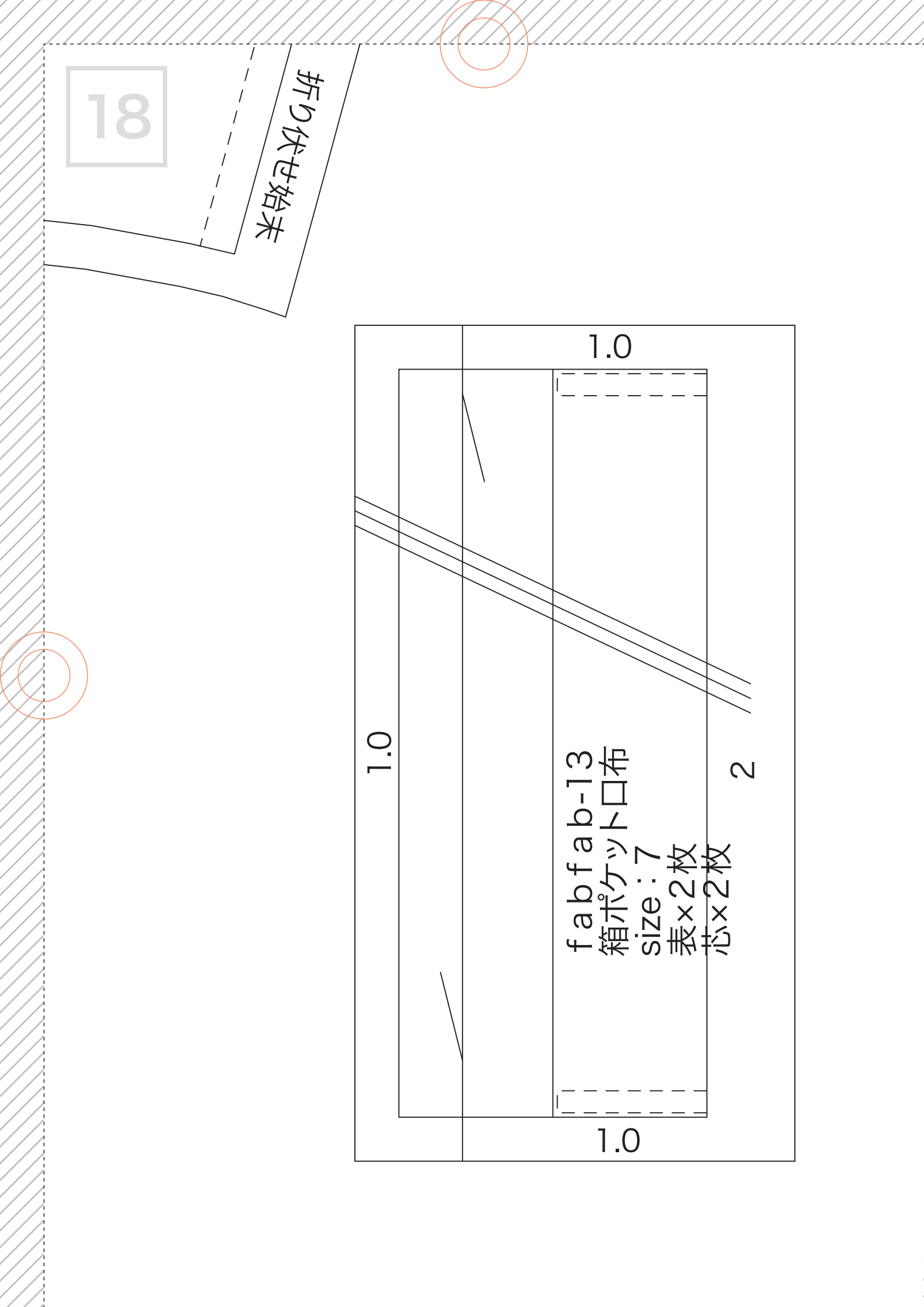

18

折り伏せ始末

1.0

1.0

fabfab-13
箱ポケット口布
size: 7
表×2枚
芯×2枚

2

1.0

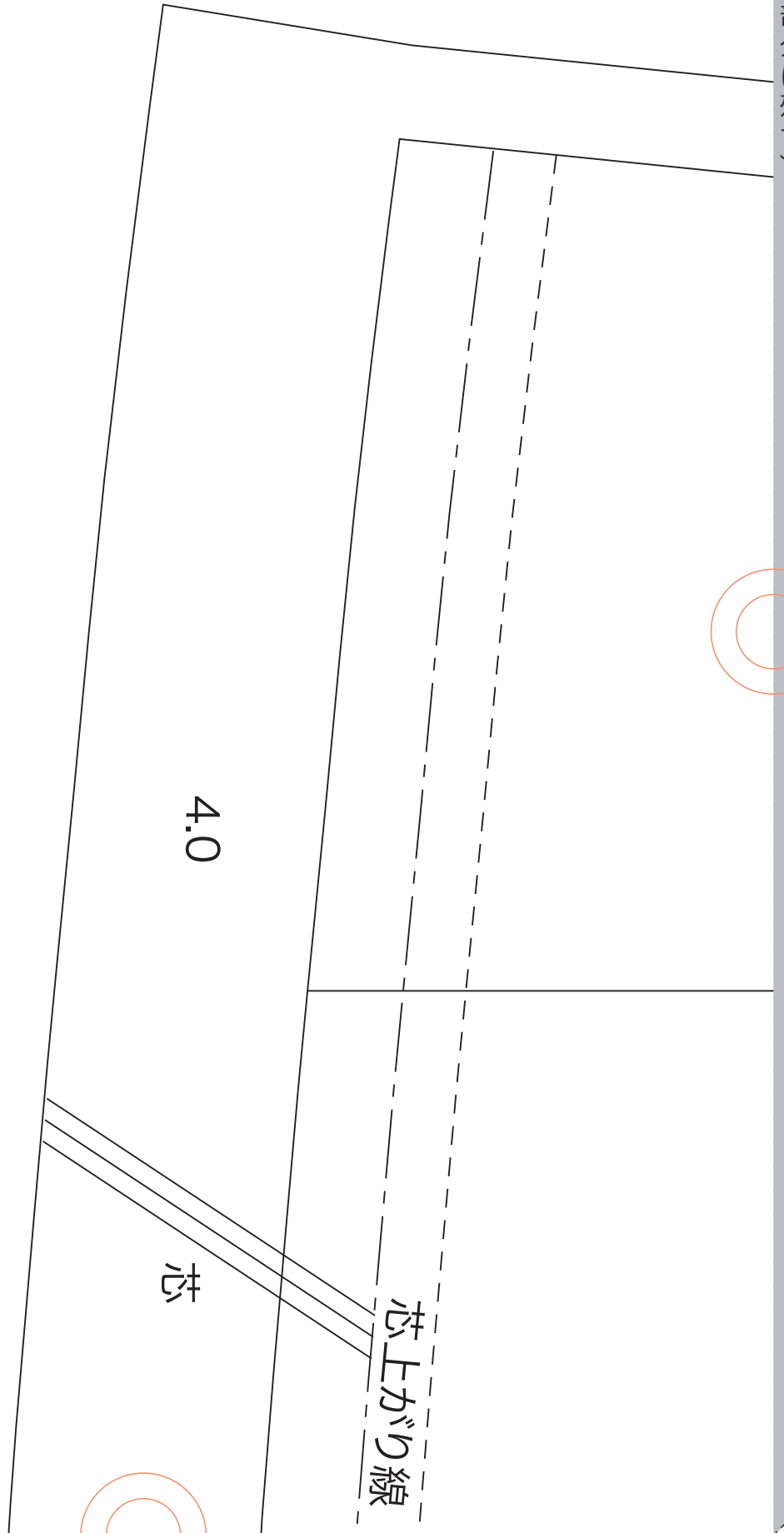

切り取る (斜線部はカット)

20

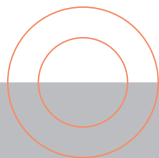
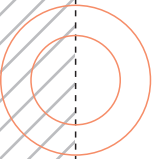
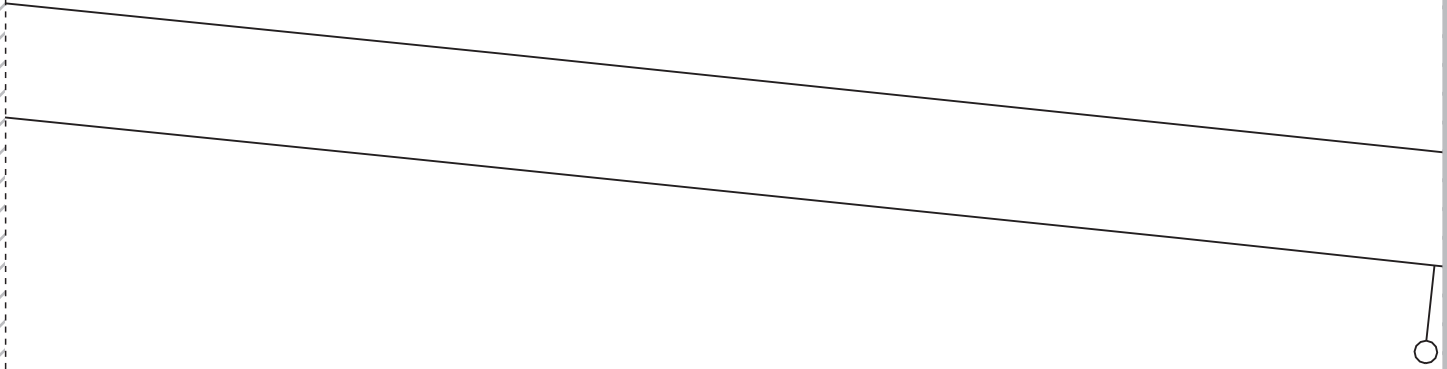

折り伏せ始末

裏地上がり線

芯

切り込み位置

箱ポケット

口布のまわり芯貼る

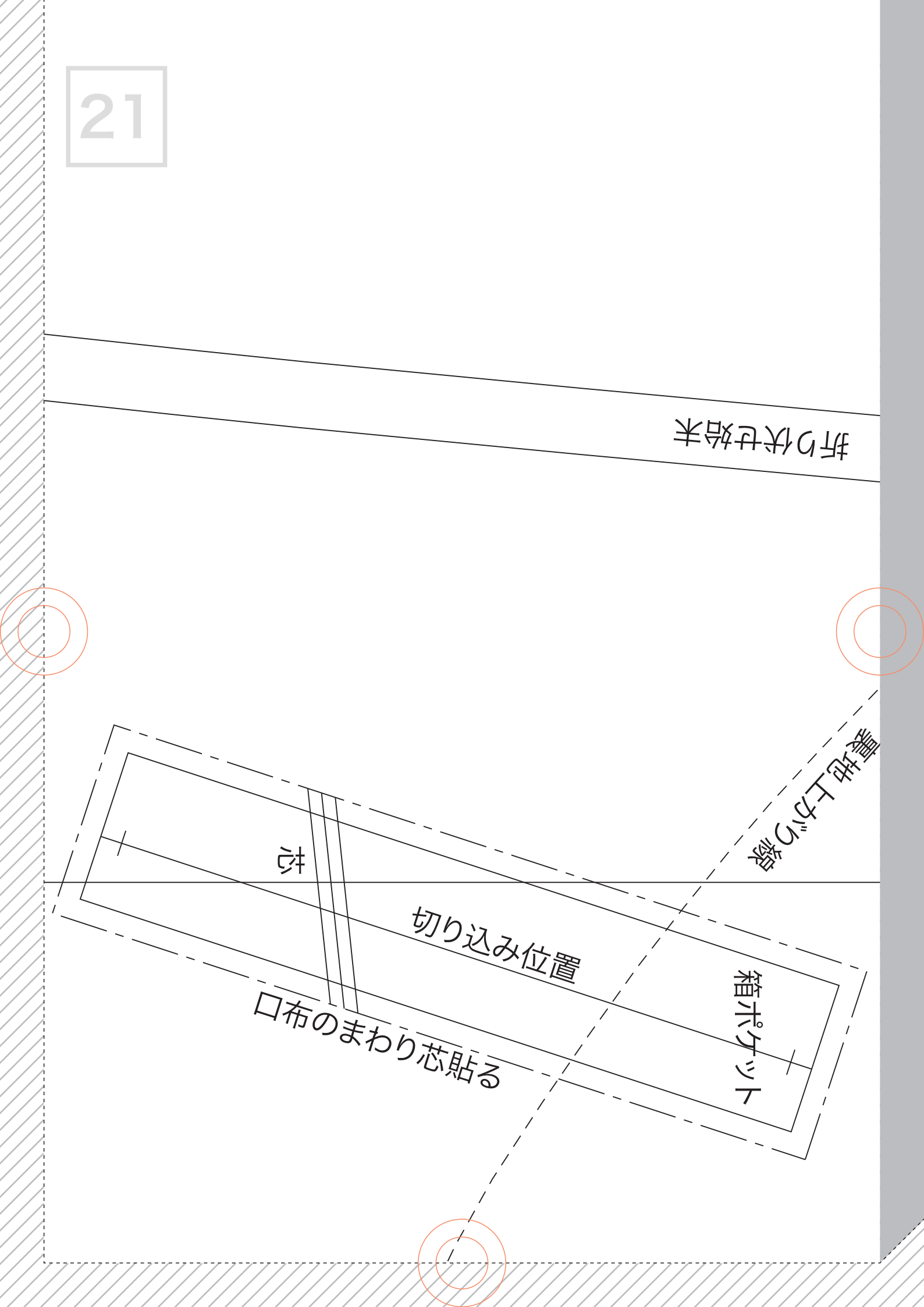

22

1.5

f a b f a b-13

前身頃

size : 7

表×2枚

23

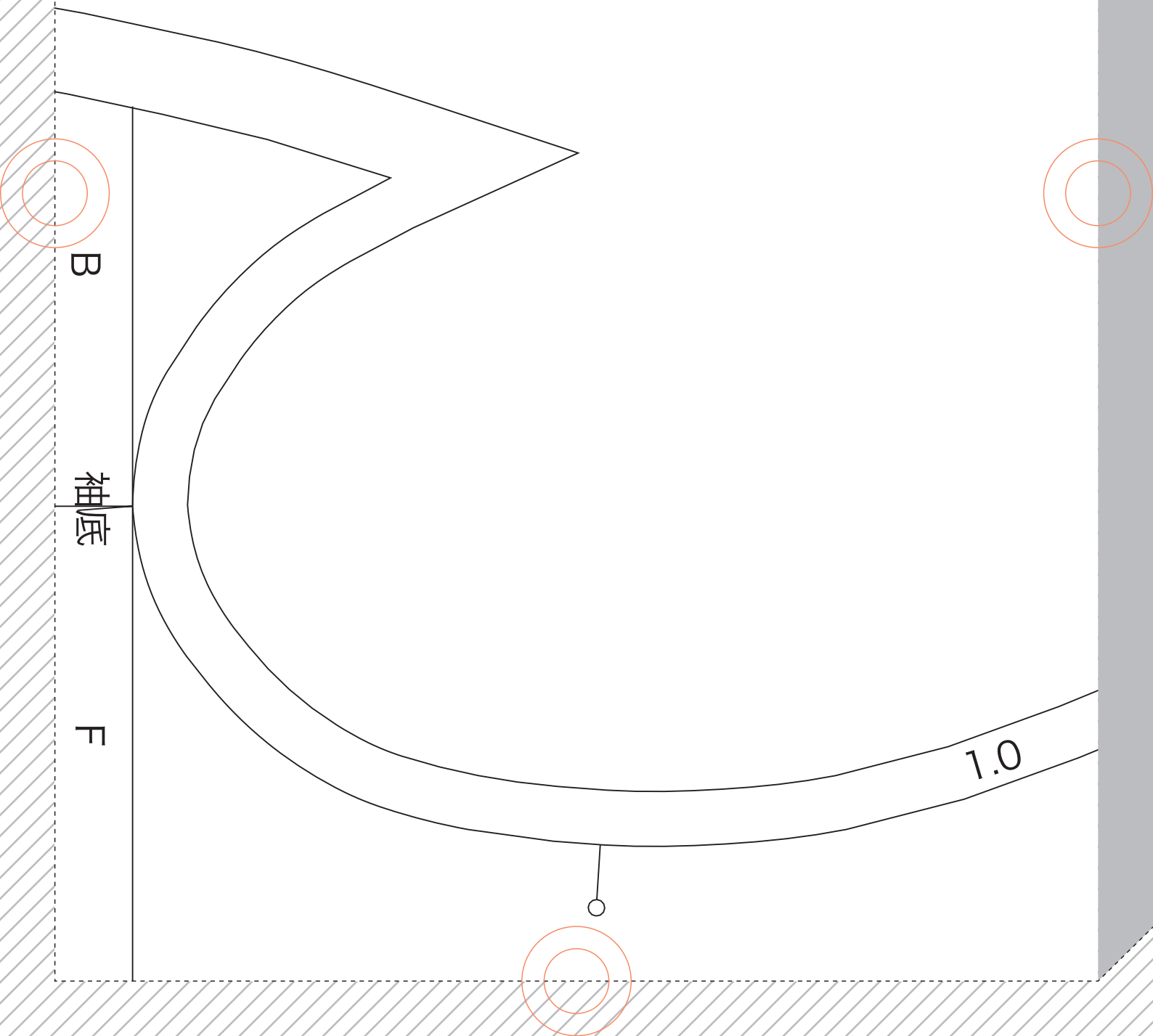

24

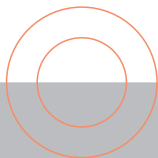
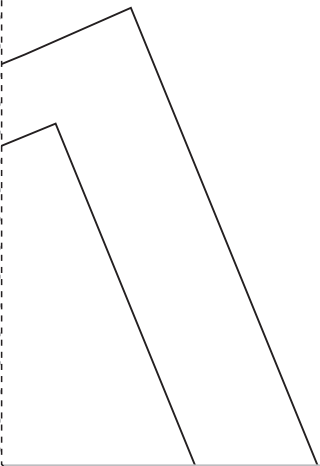
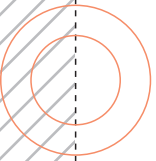

25

三ツ折り始末

2.5cmヌテツチ

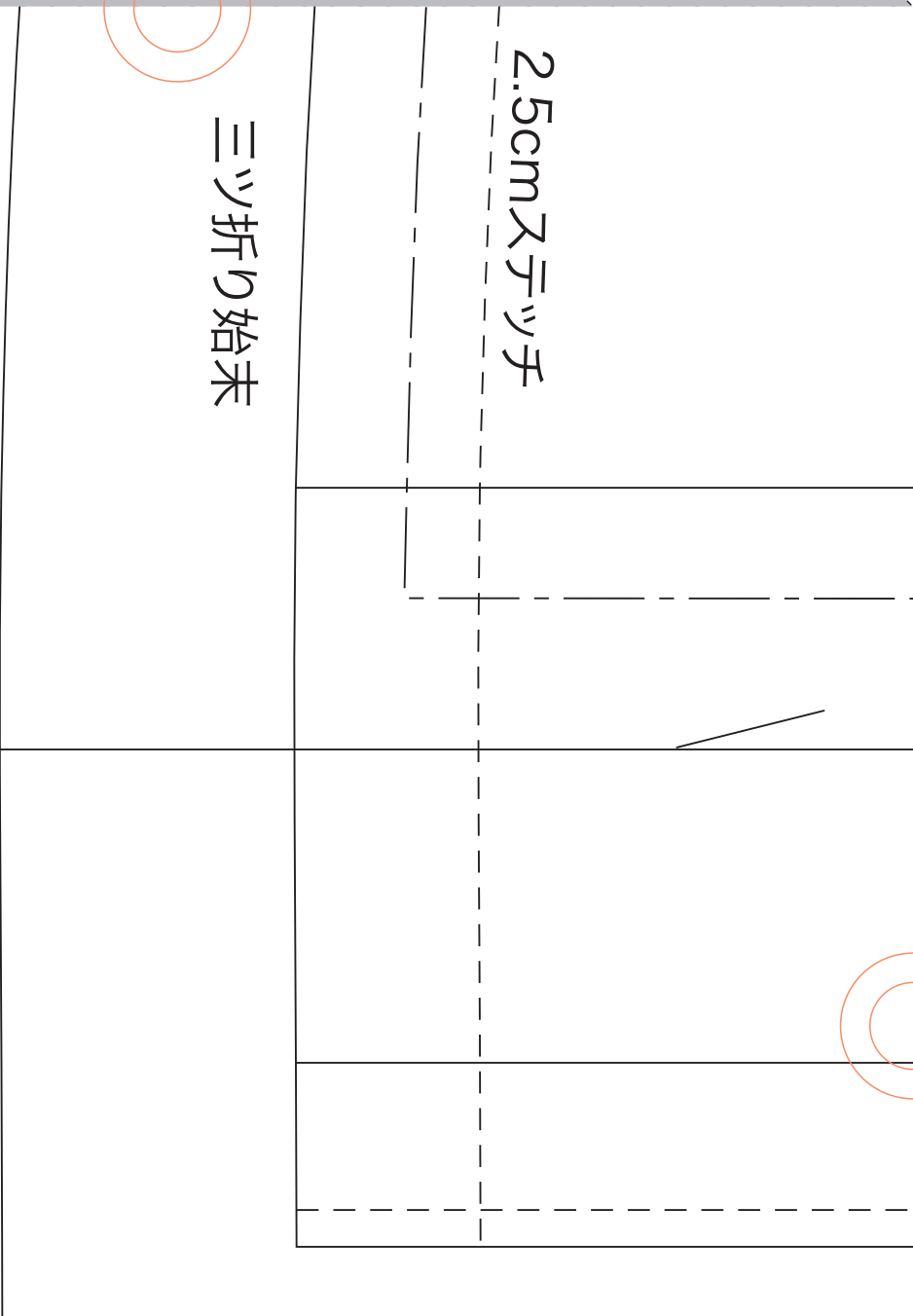

26

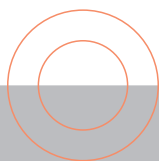
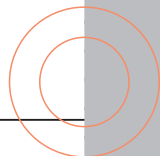
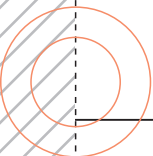
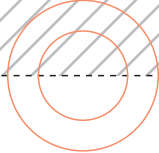

27

見返し線

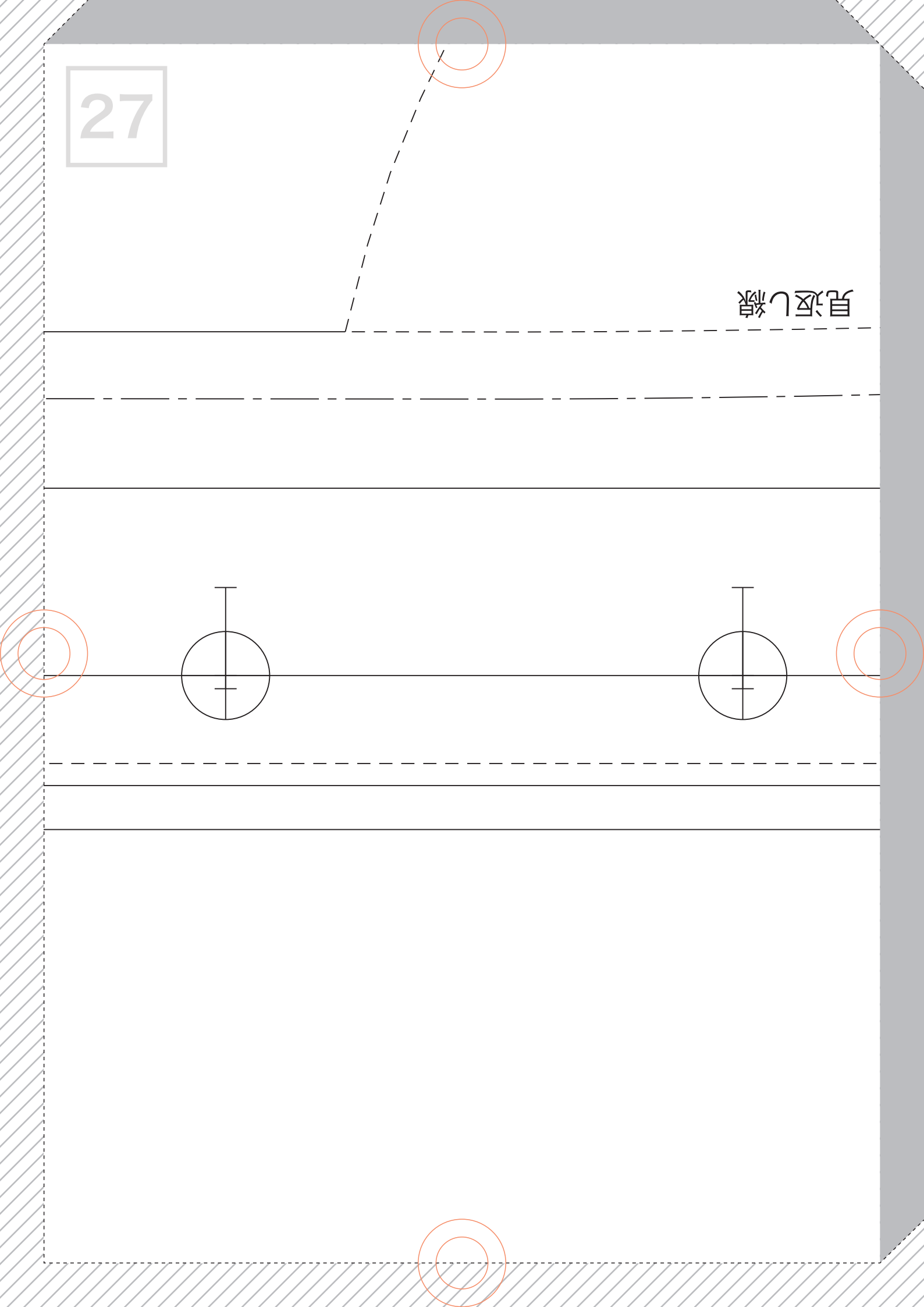

28

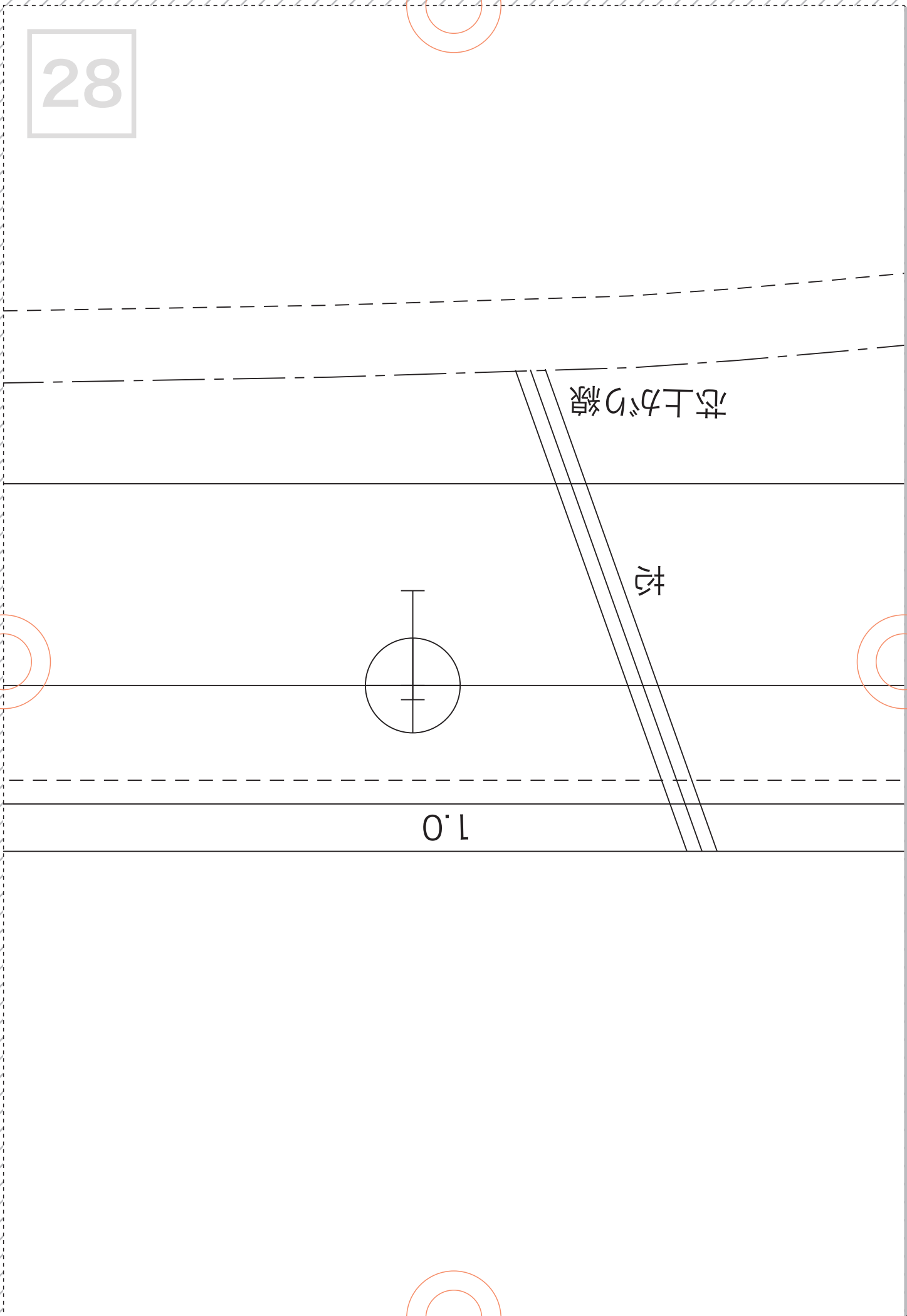

芯上かり線

杉

1.0

29

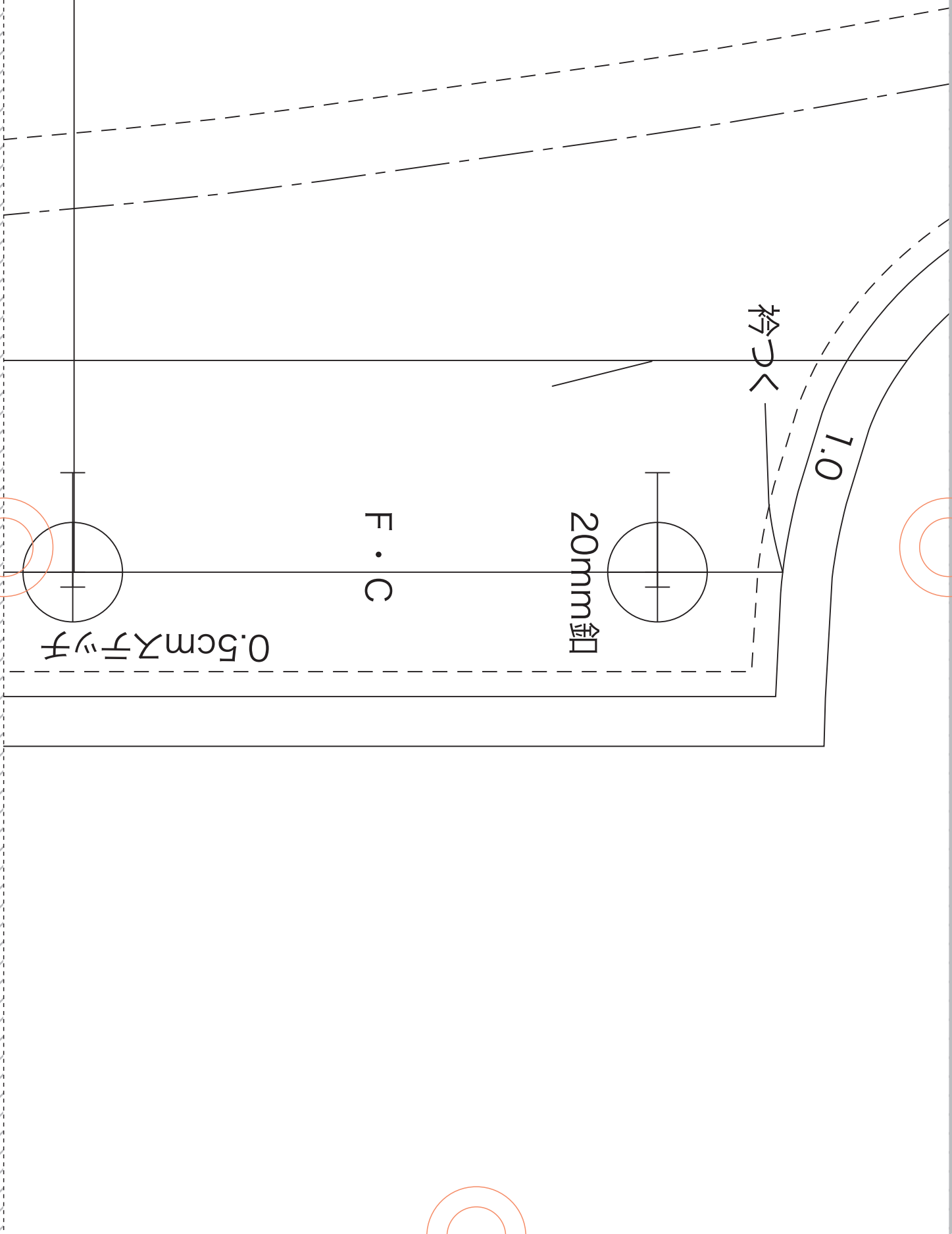

枠づく

1.0

20mm 釘

F・C

0.5cm ステッチ

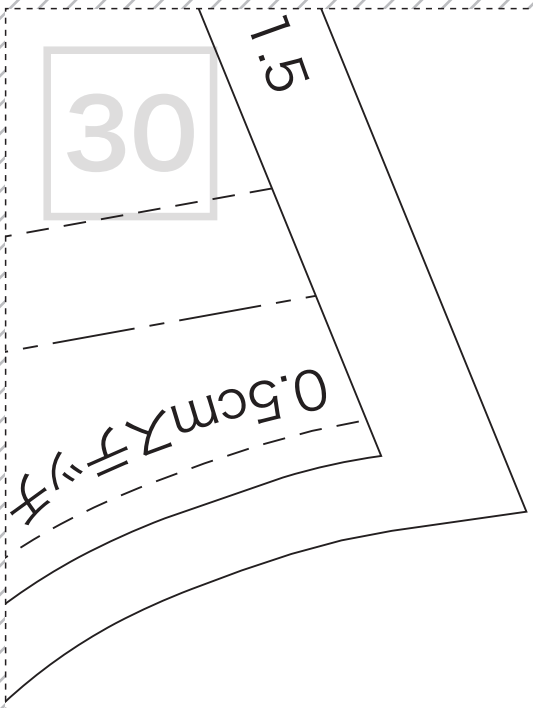

30

1.5

0.5cm

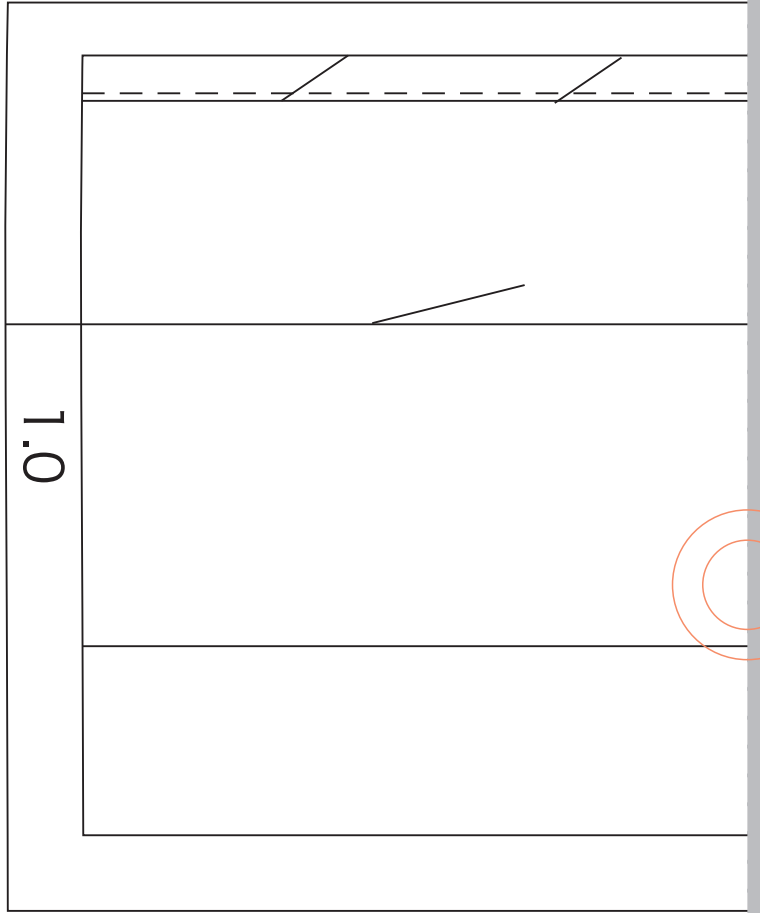
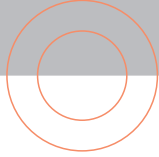

32

6mmパイカステーブ始末

33

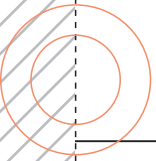
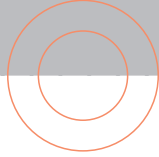

34

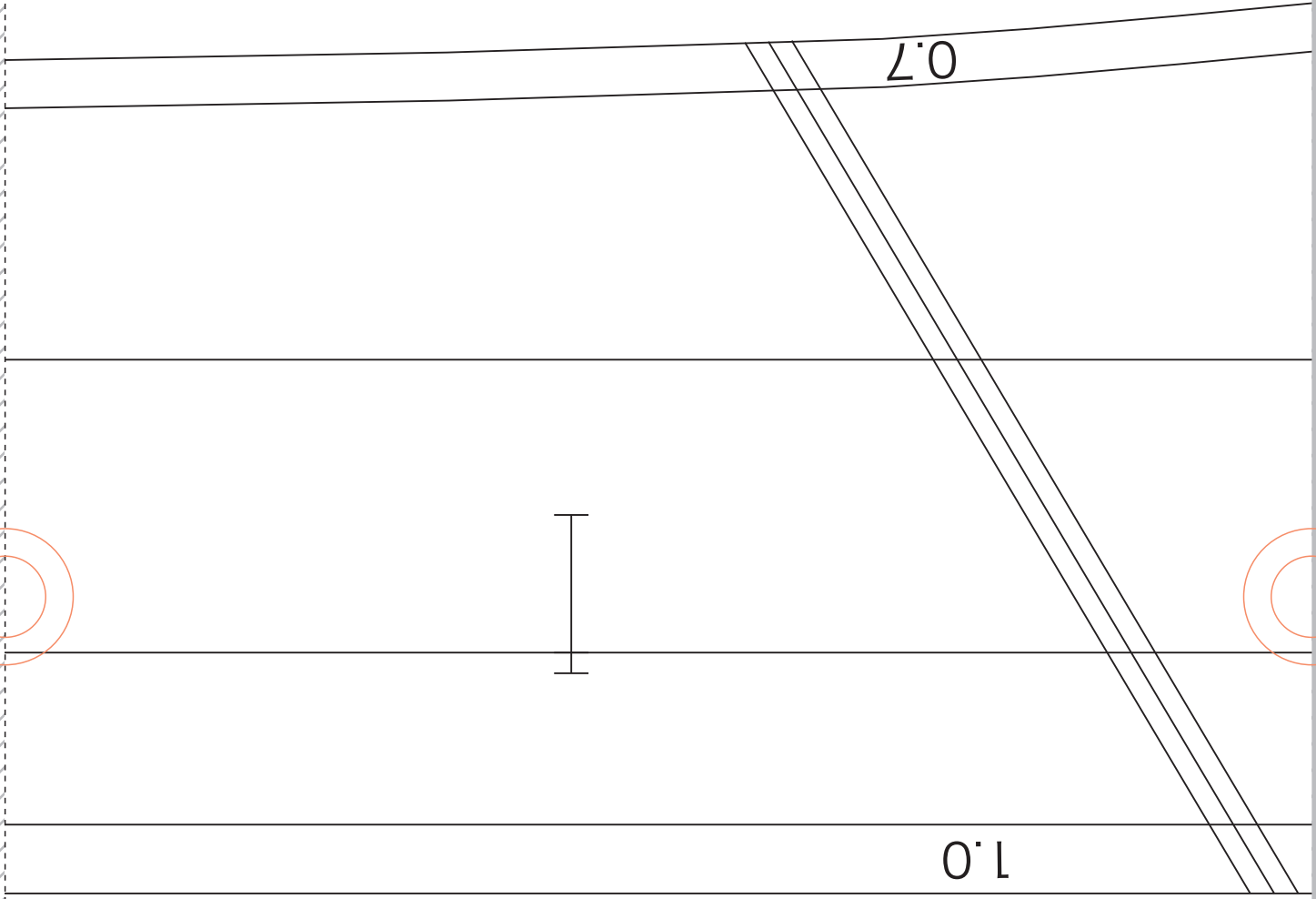
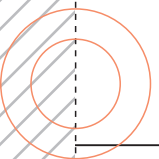
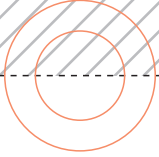

35

fabfab-13
前見返し
size : 7
表×2枚
芯×2枚

F・C

1.0

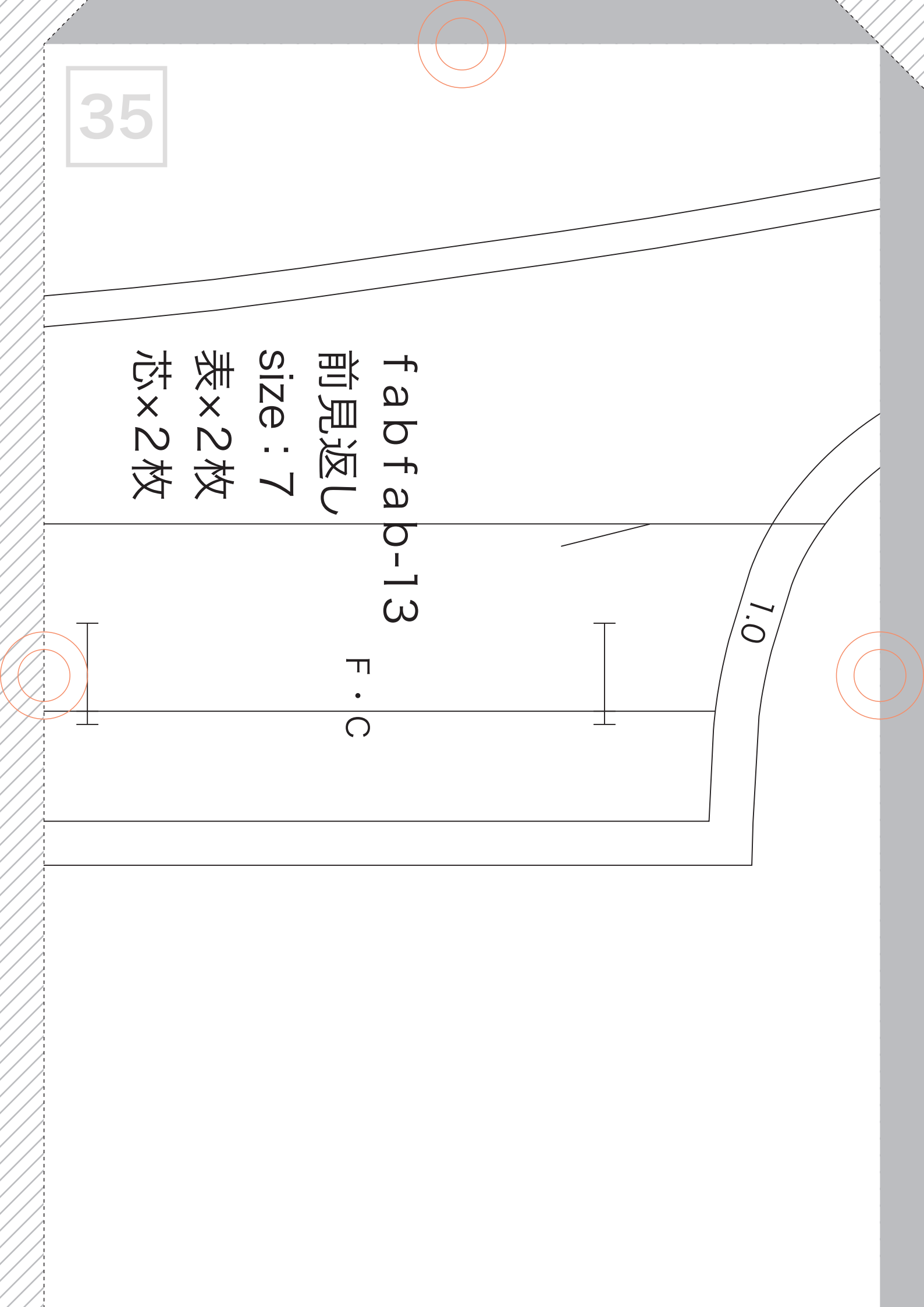

36

1.0

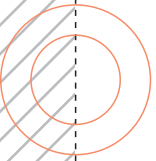
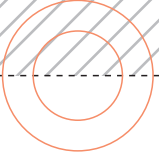

37

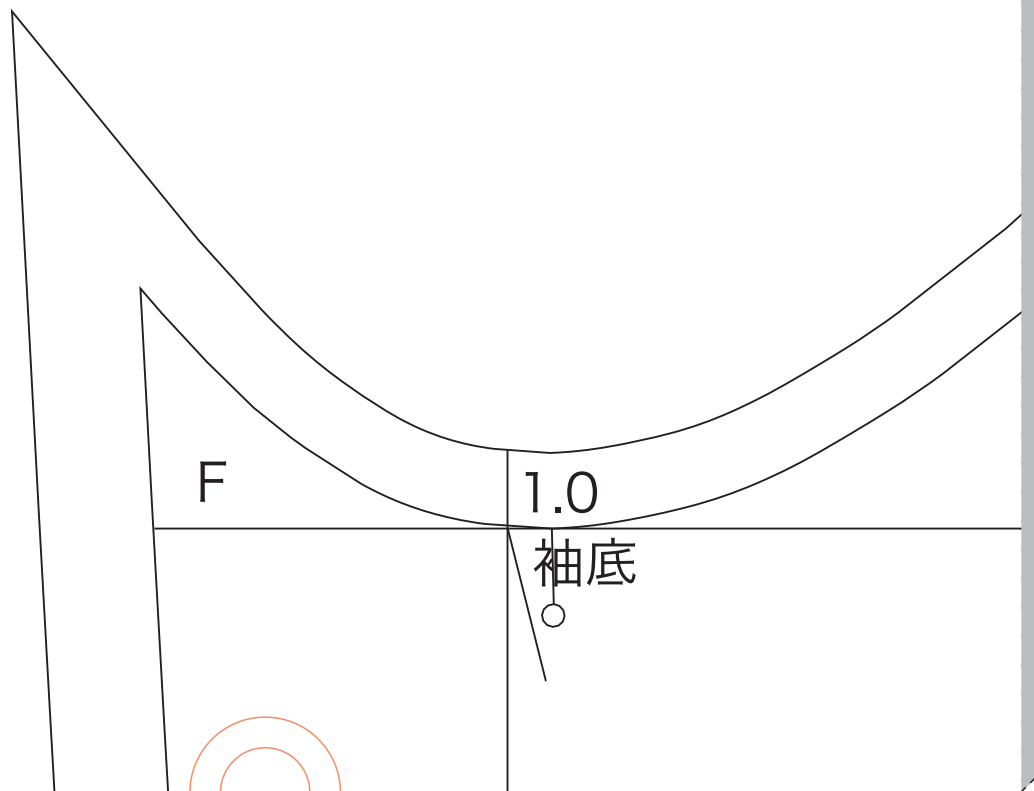

切り取る (斜線部はカット)

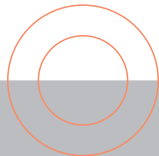
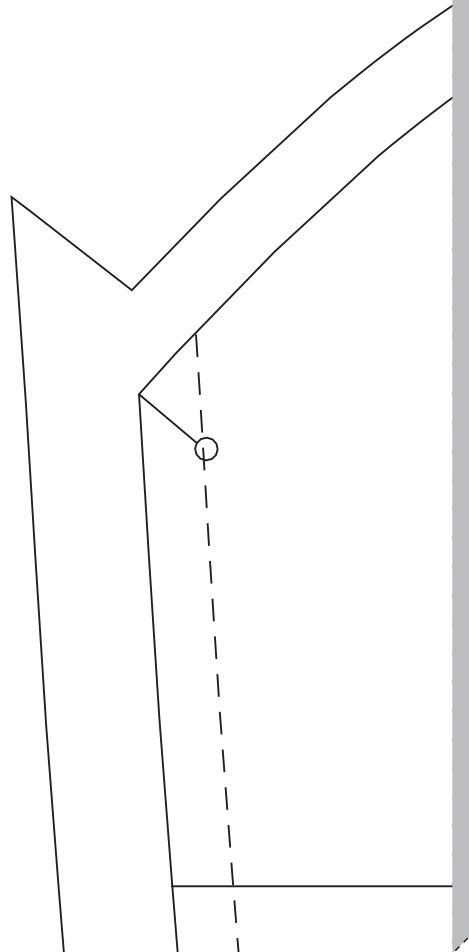
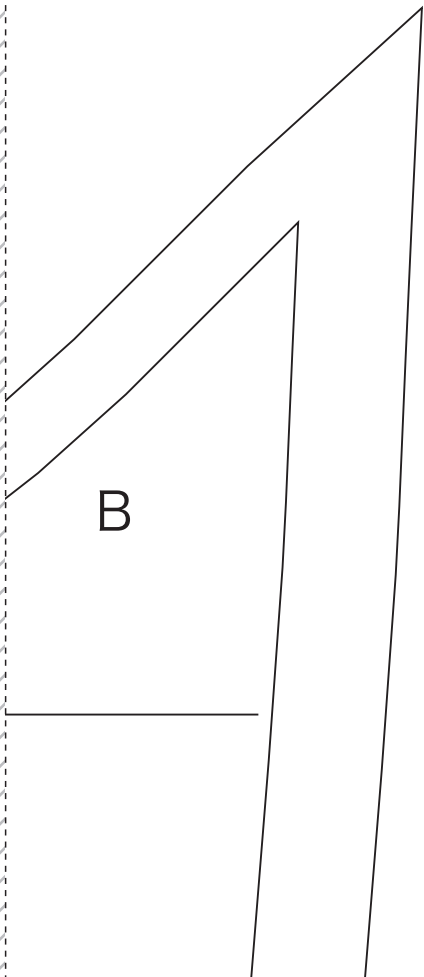
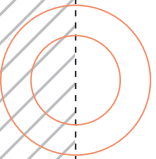

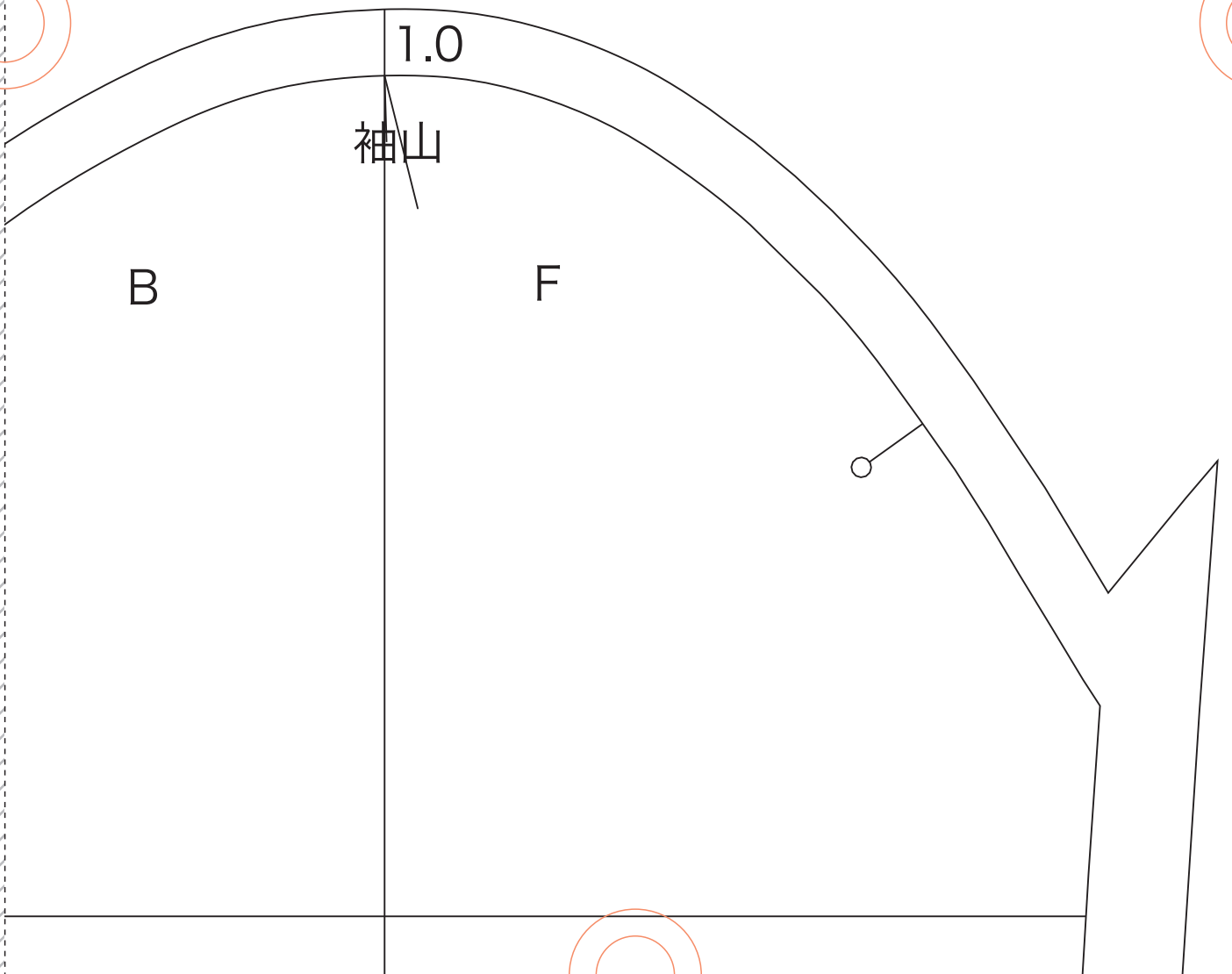

40

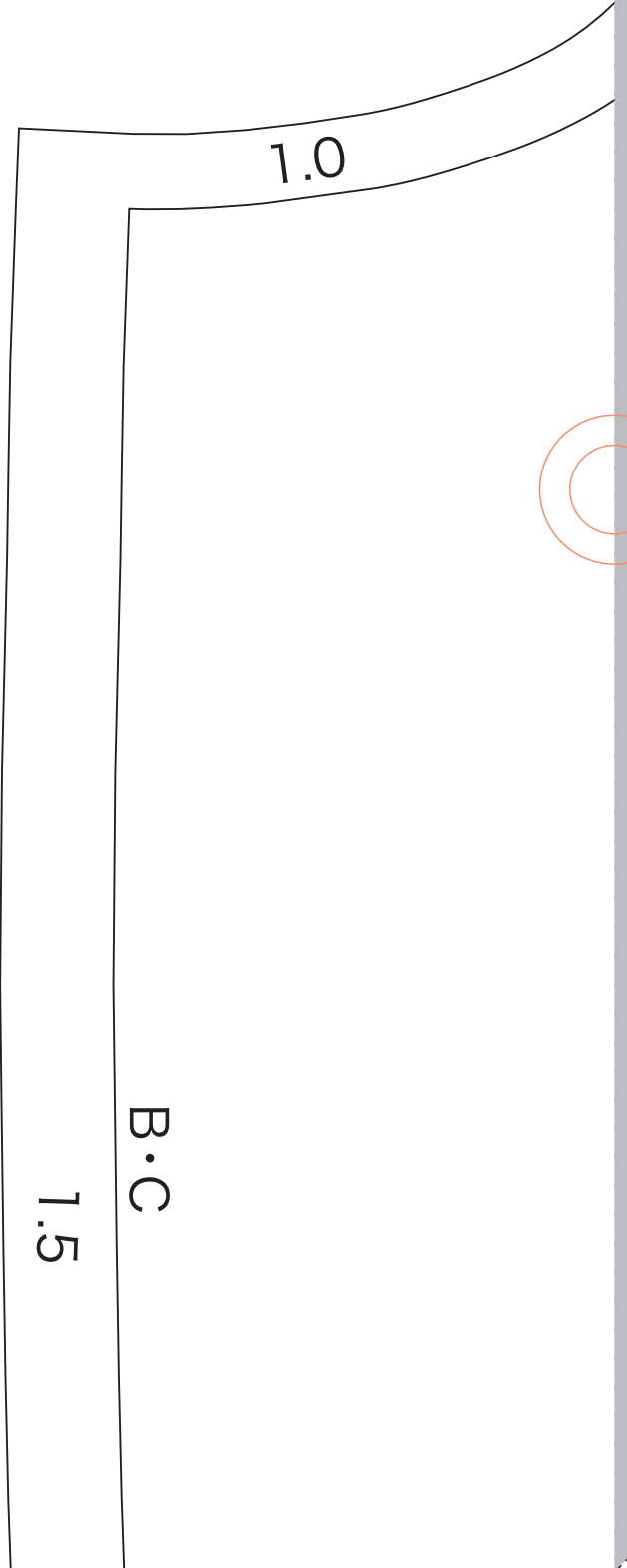
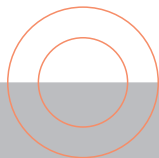
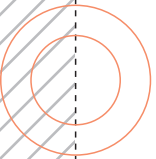

41

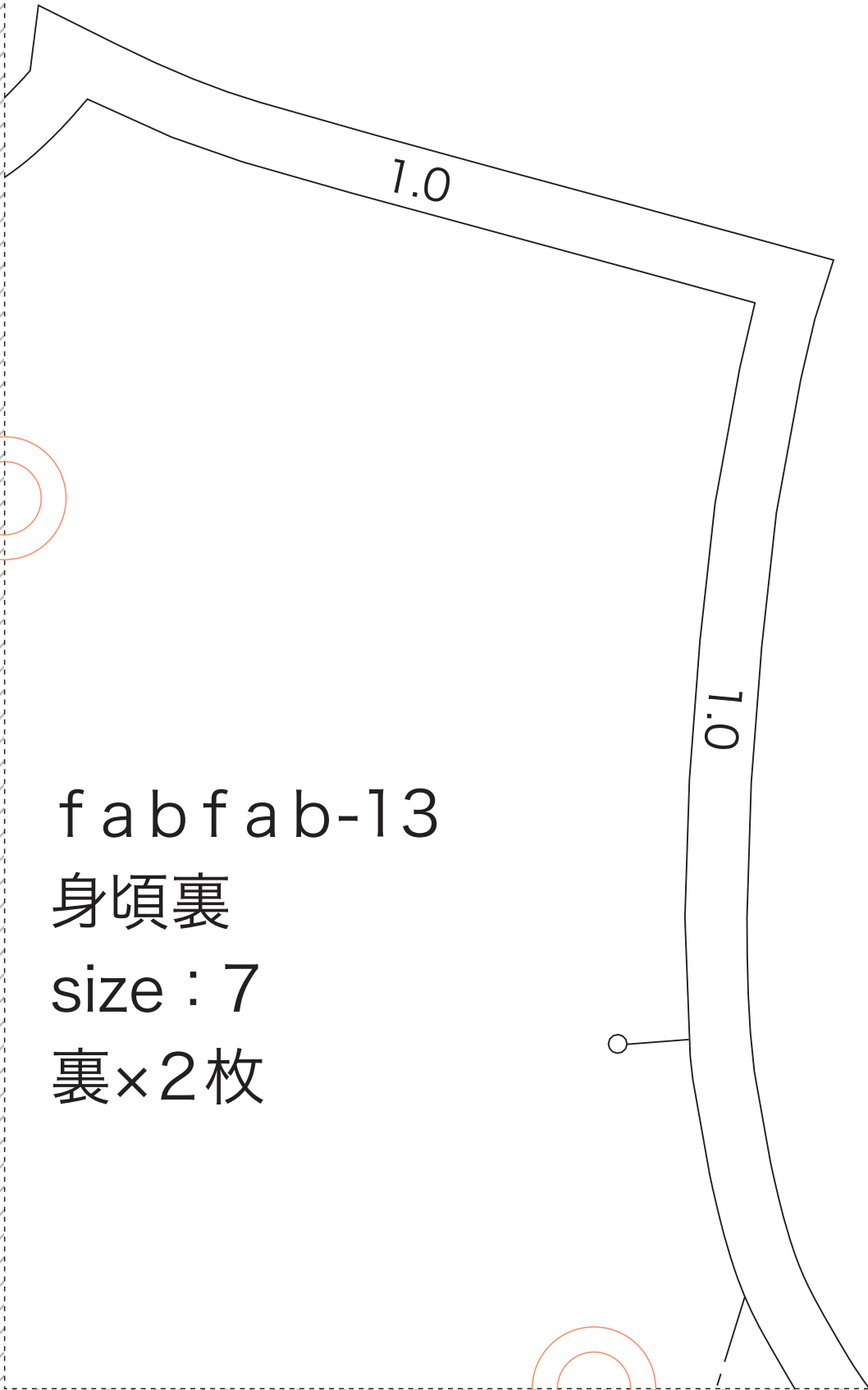

fabfab-13

身頃裏

size : 7

裏×2枚

42

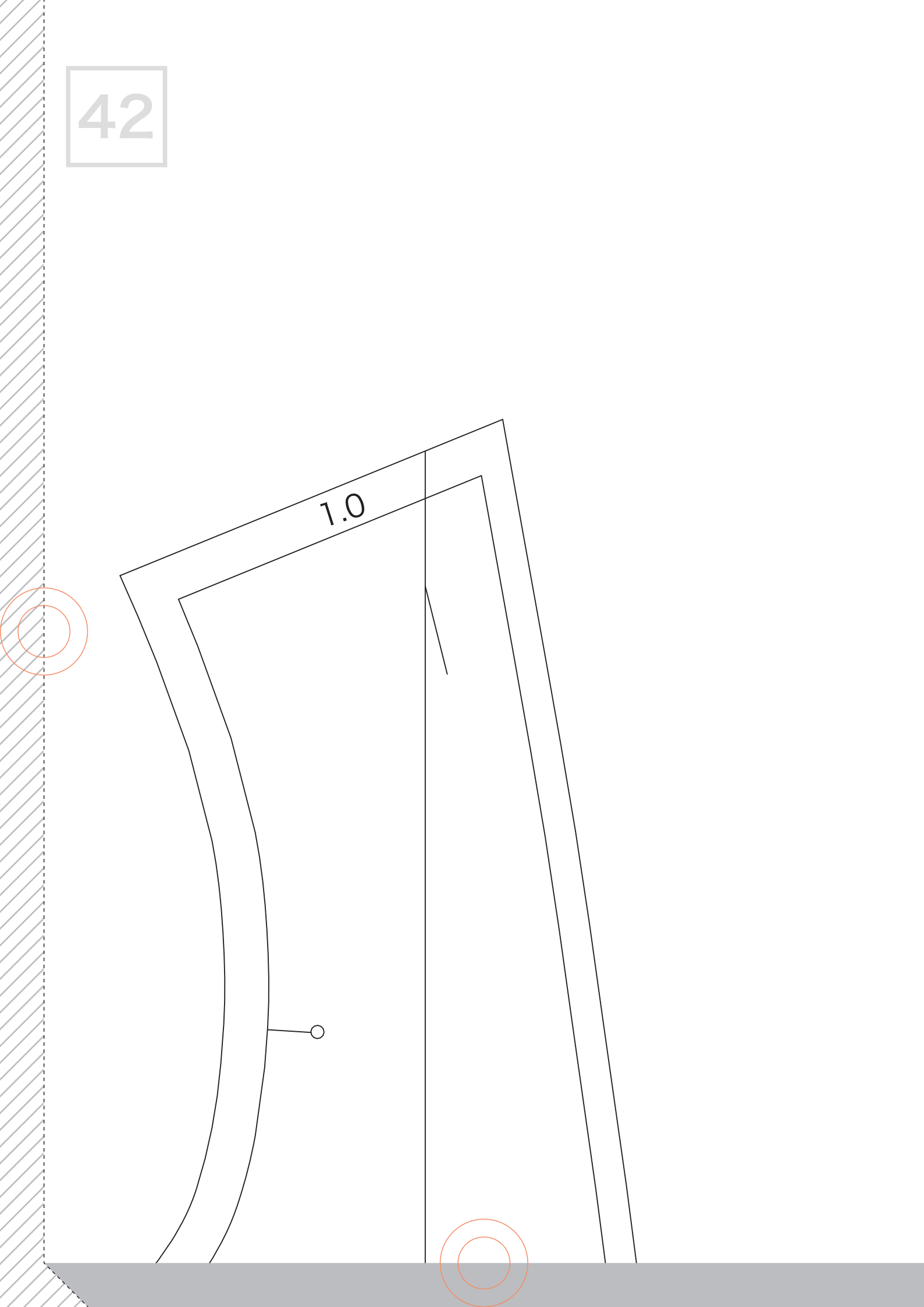

43

6mmバイヤステープ始末 割り

1.5

f a b f a b-13

内袖

size : 7

表×2枚

44

1.5 折り伏せ始末

1.5 折り伏せ始末

0.8cmステッチ

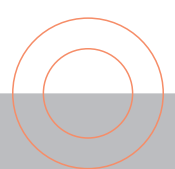
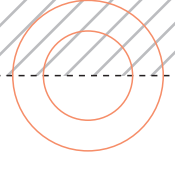
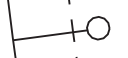
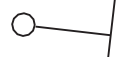

45

f a b f a b-13

外袖

size : 7

表×2枚

6mmバイヤステープ始末 割り

1.5

46

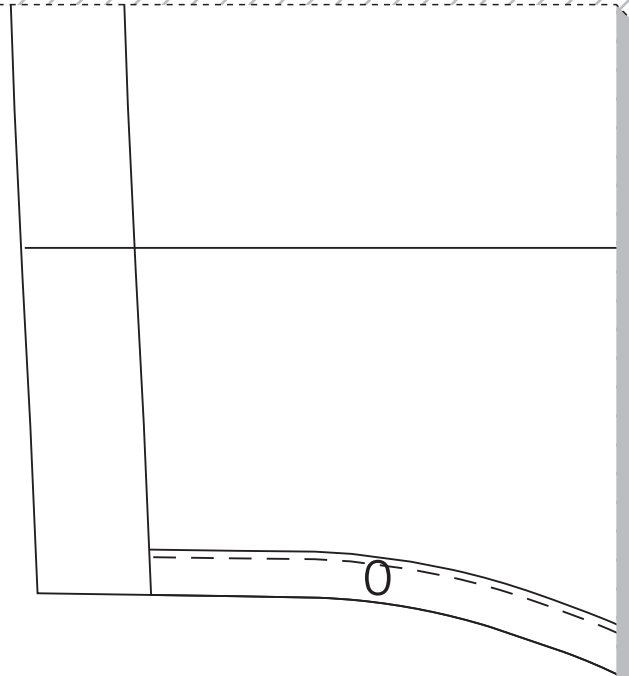
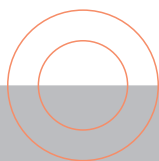
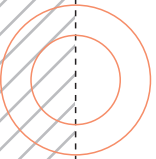
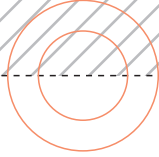

0

47

B

袖底

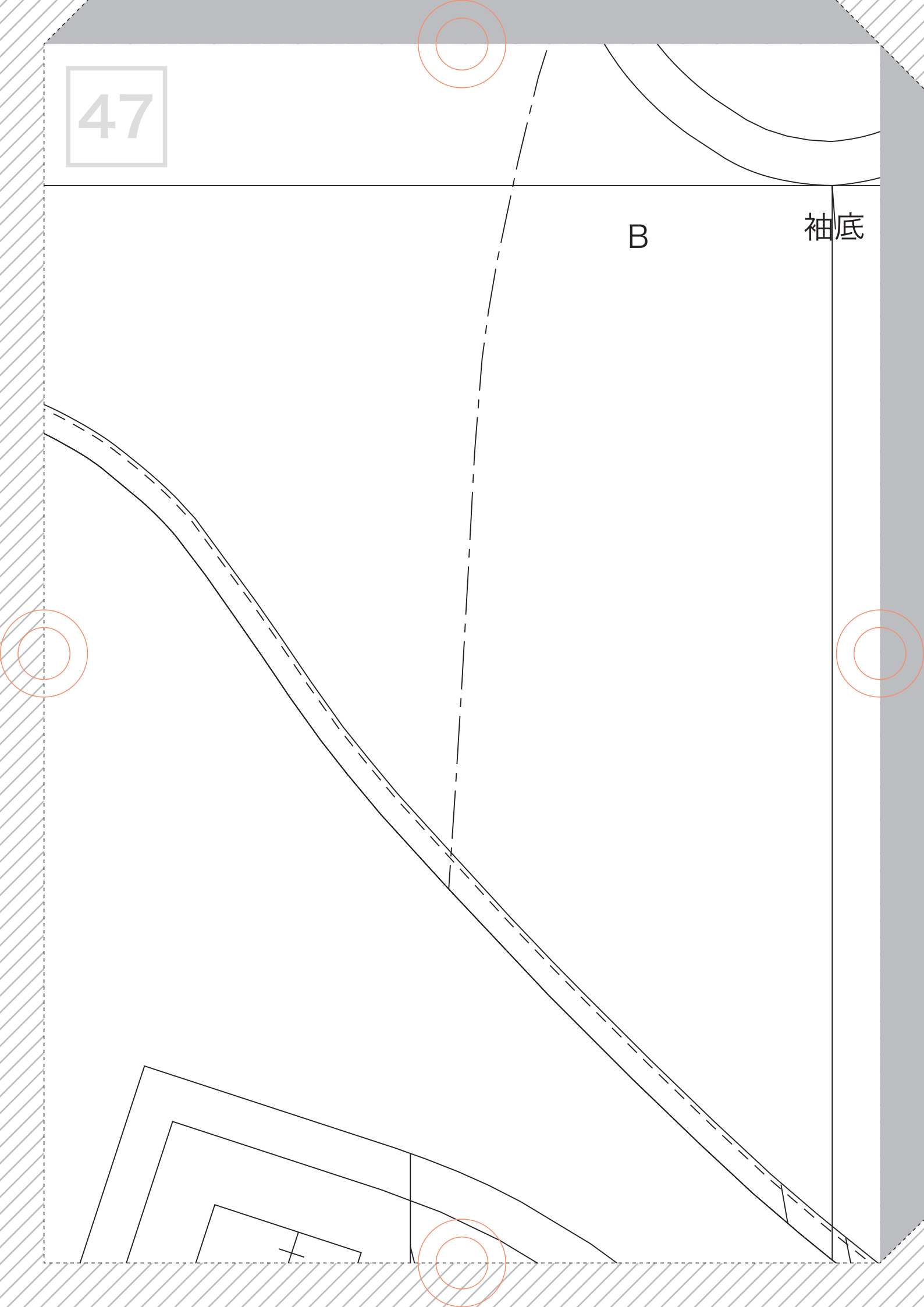

48

F

0.7 前見返しとはぐ

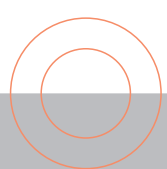
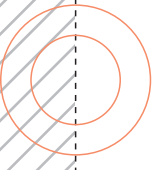
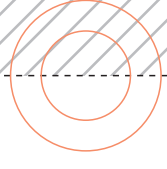

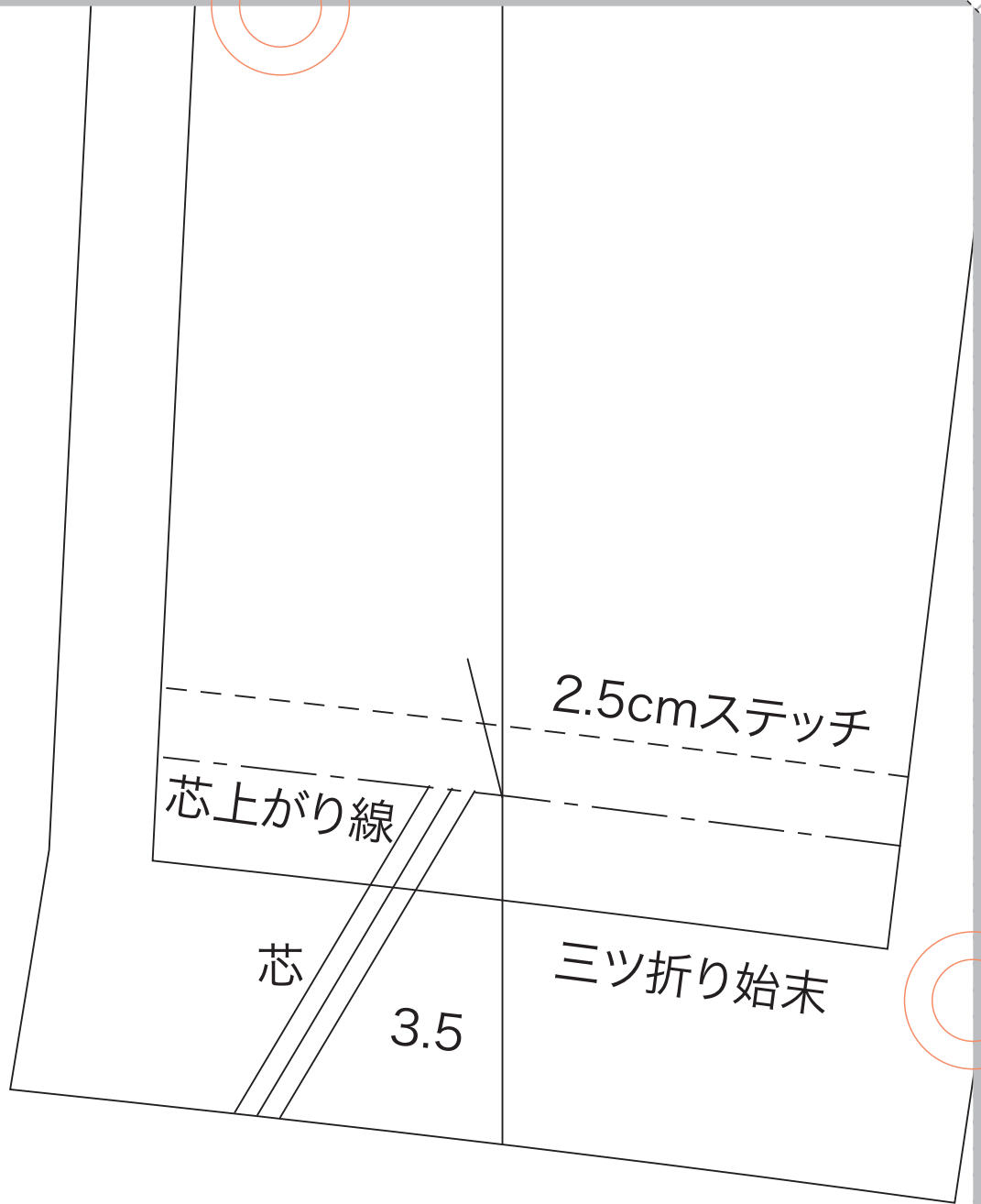

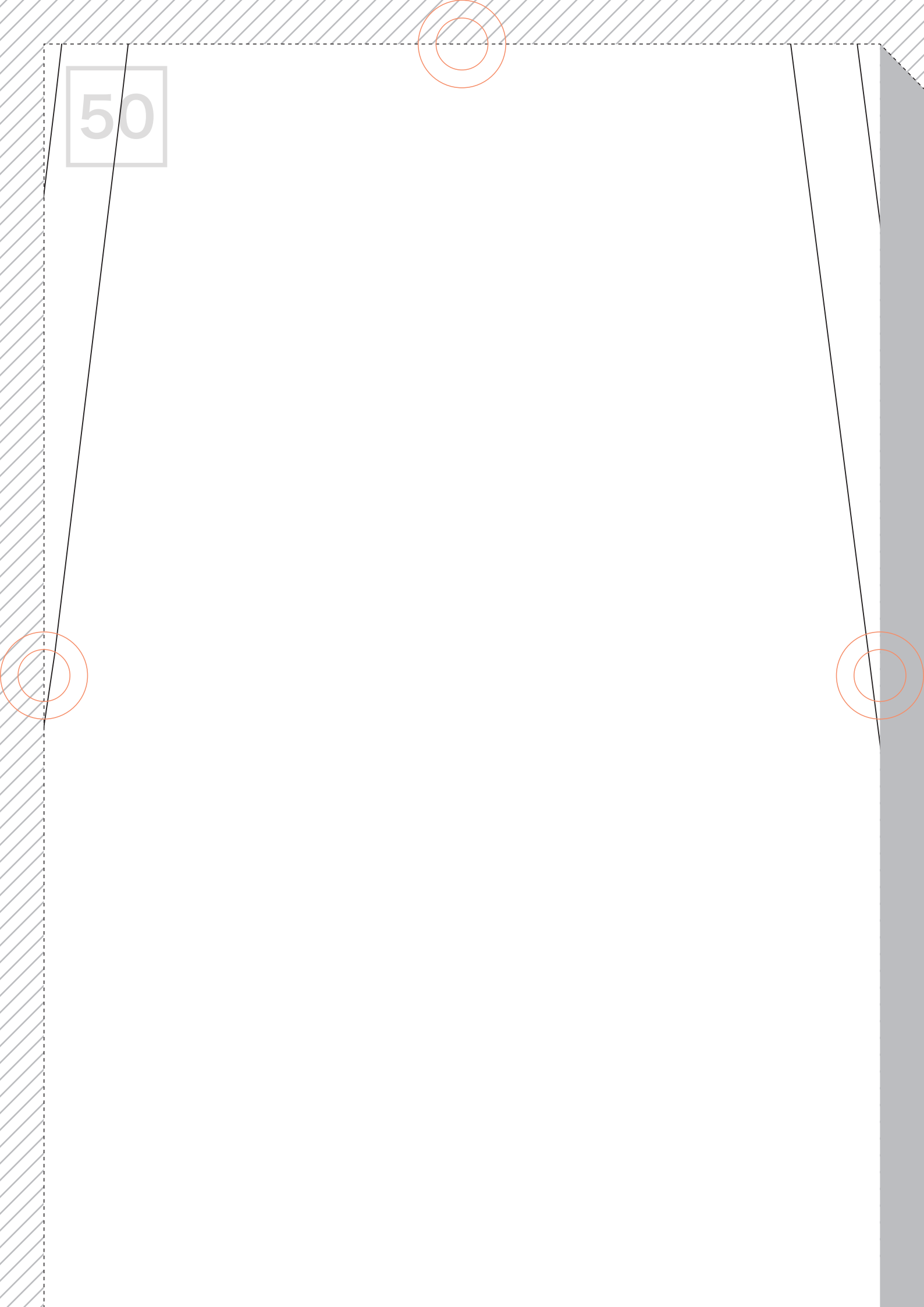

50

51

2.5cmステッチ

芯上がり線

三ツ折り始末

3.5

芯

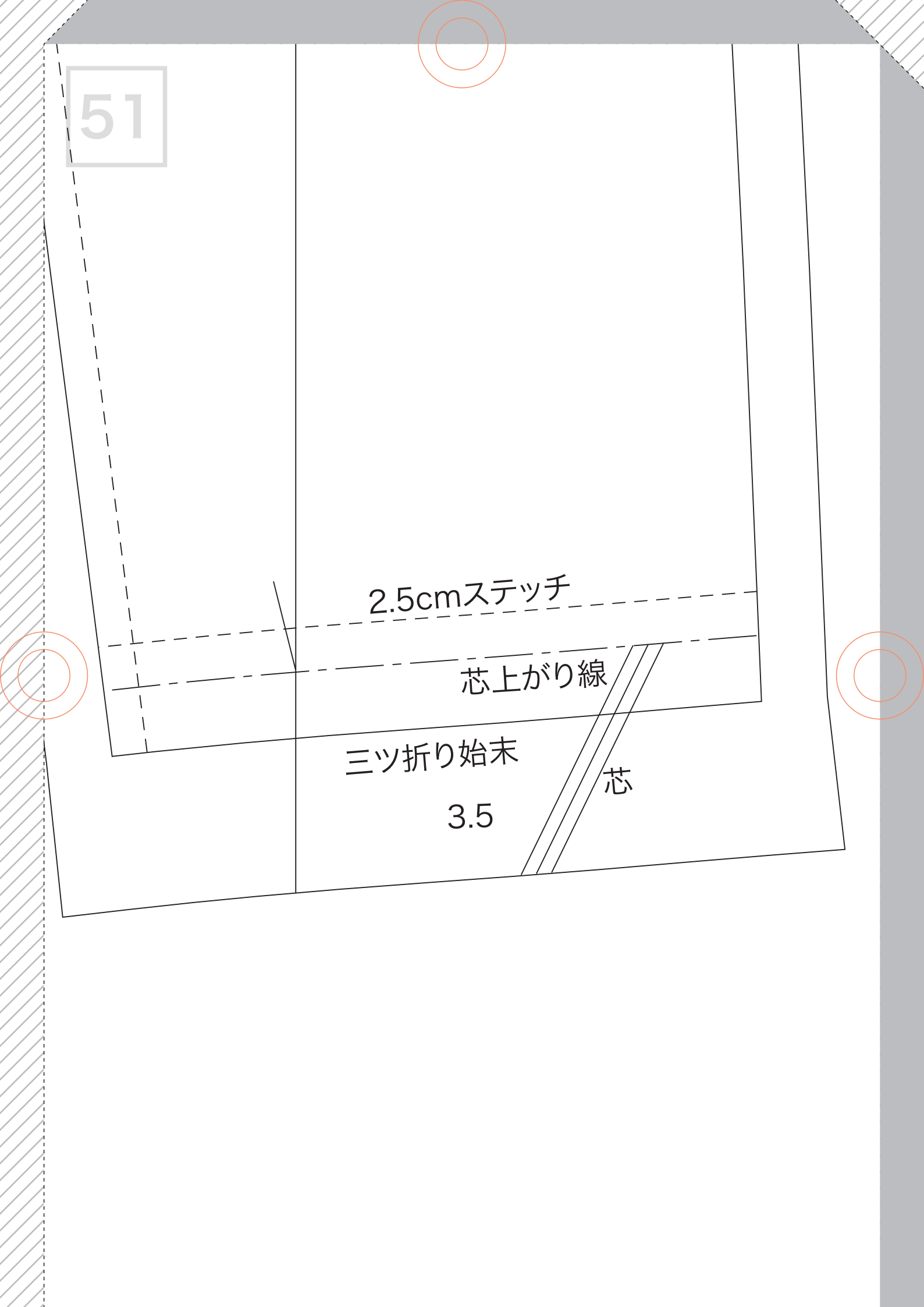

52

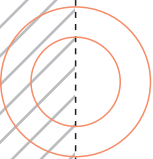
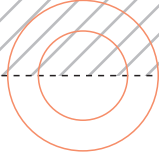

1:0

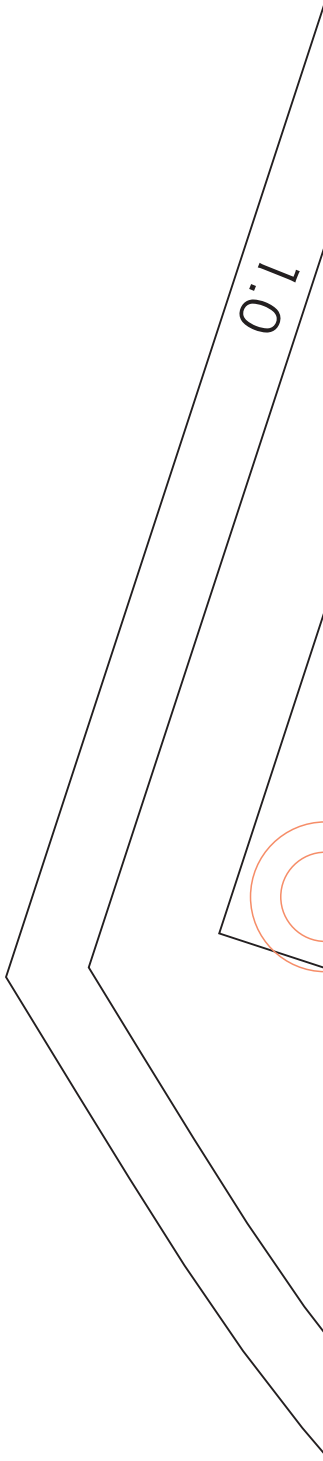
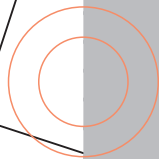

53

fabfab-13
箱ポケット袋布
size : 7
表×4枚

6mmバイヤステーラ始末

1.0

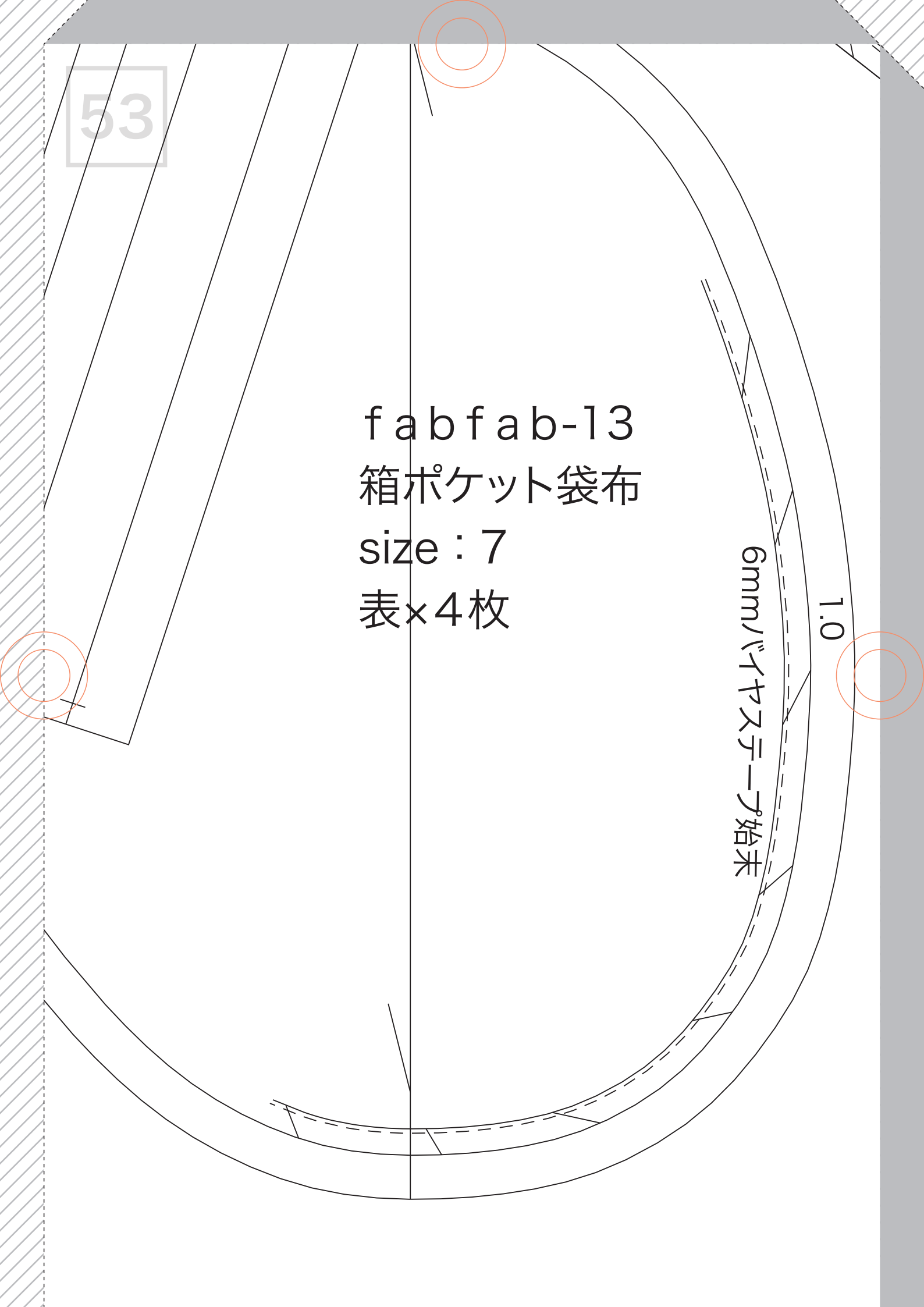

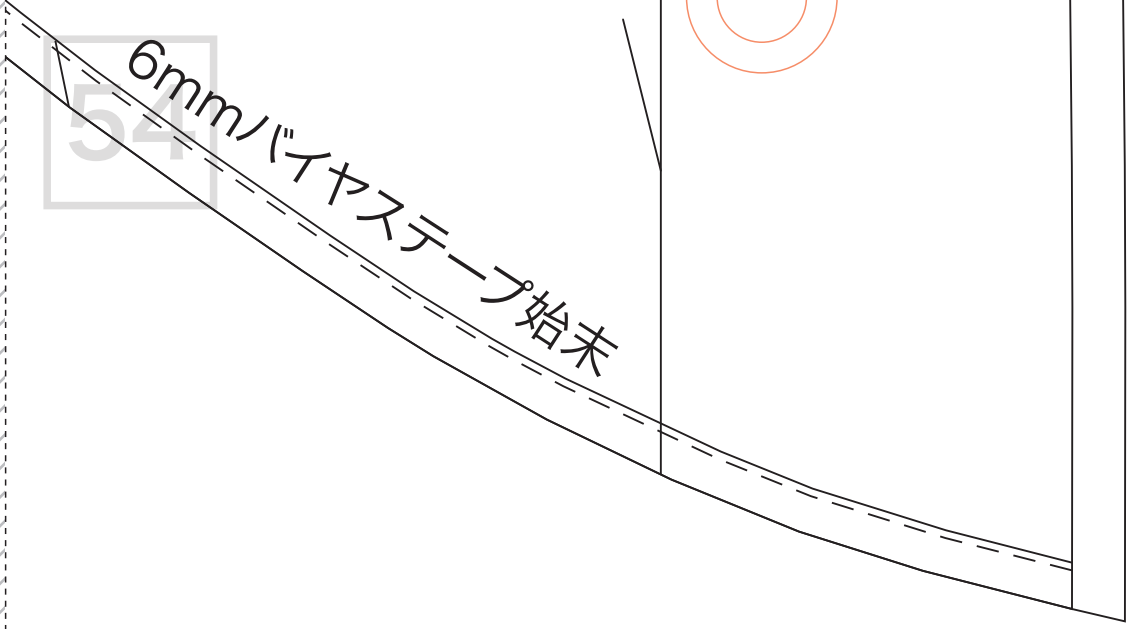
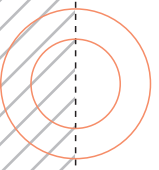
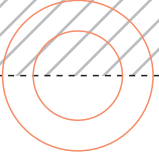

54

6mmバイヤステープ始末