

## introduction はじめに

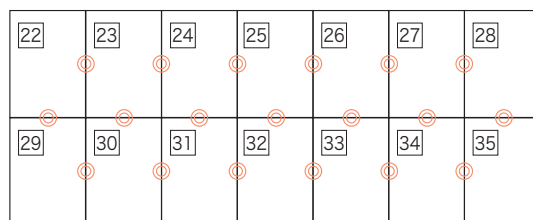
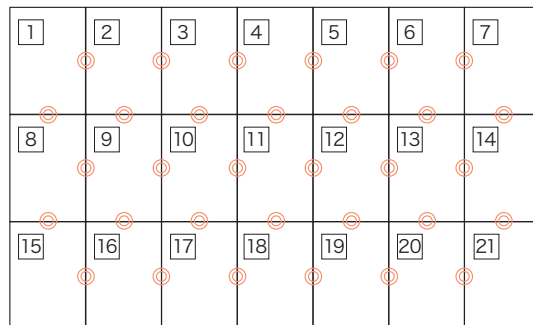

パターンは A4 サイズ 35 枚に分割されています。  
印刷後、右図のようにつなぎ合わせてください。

### ! 印刷時の注意

印刷設定では、「ページの拡大や縮小」を選択せず  
必ず、「実際のサイズ」(原寸) で印刷してください。



## how to make パターンのつくりかた

- STEP1** 斜線部分  は切り取り、灰色部分  は残してのりしろにします。  
(斜線と灰色を間違えないように注意)
- STEP2** 各用紙の番号を確認し、 の位置を合わせて、のりづけします。  
(水のりは用紙が波打ちます。スティック糊などをお使いください)
- STEP3** それぞれのパーツをハサミで切り出します。

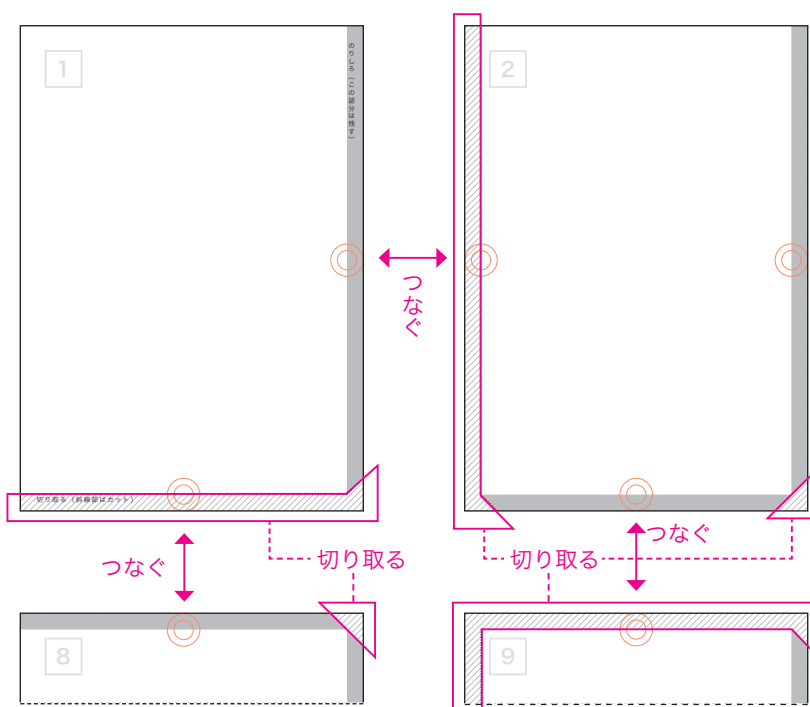

1

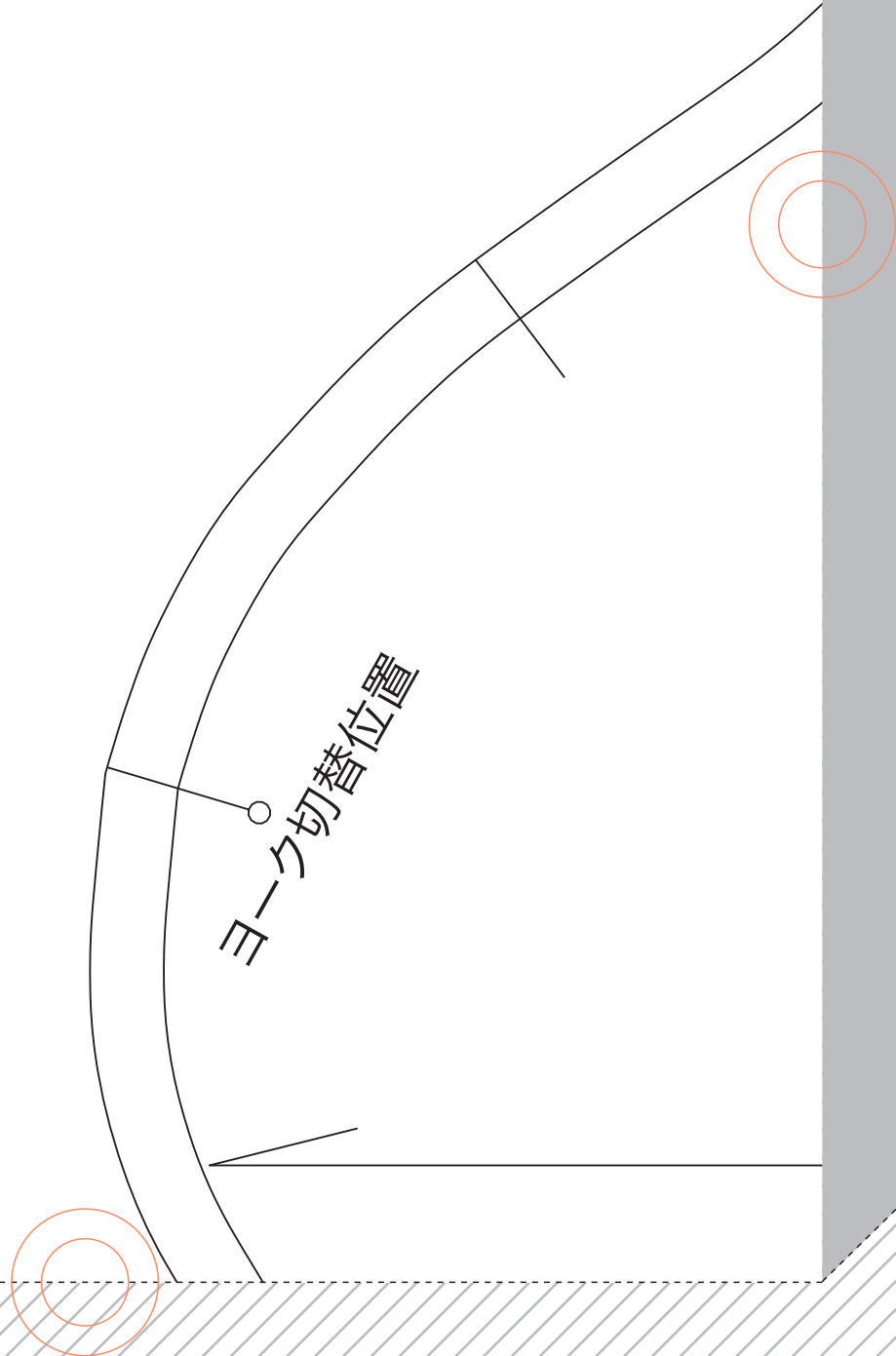

切り取る（斜線部はカット）

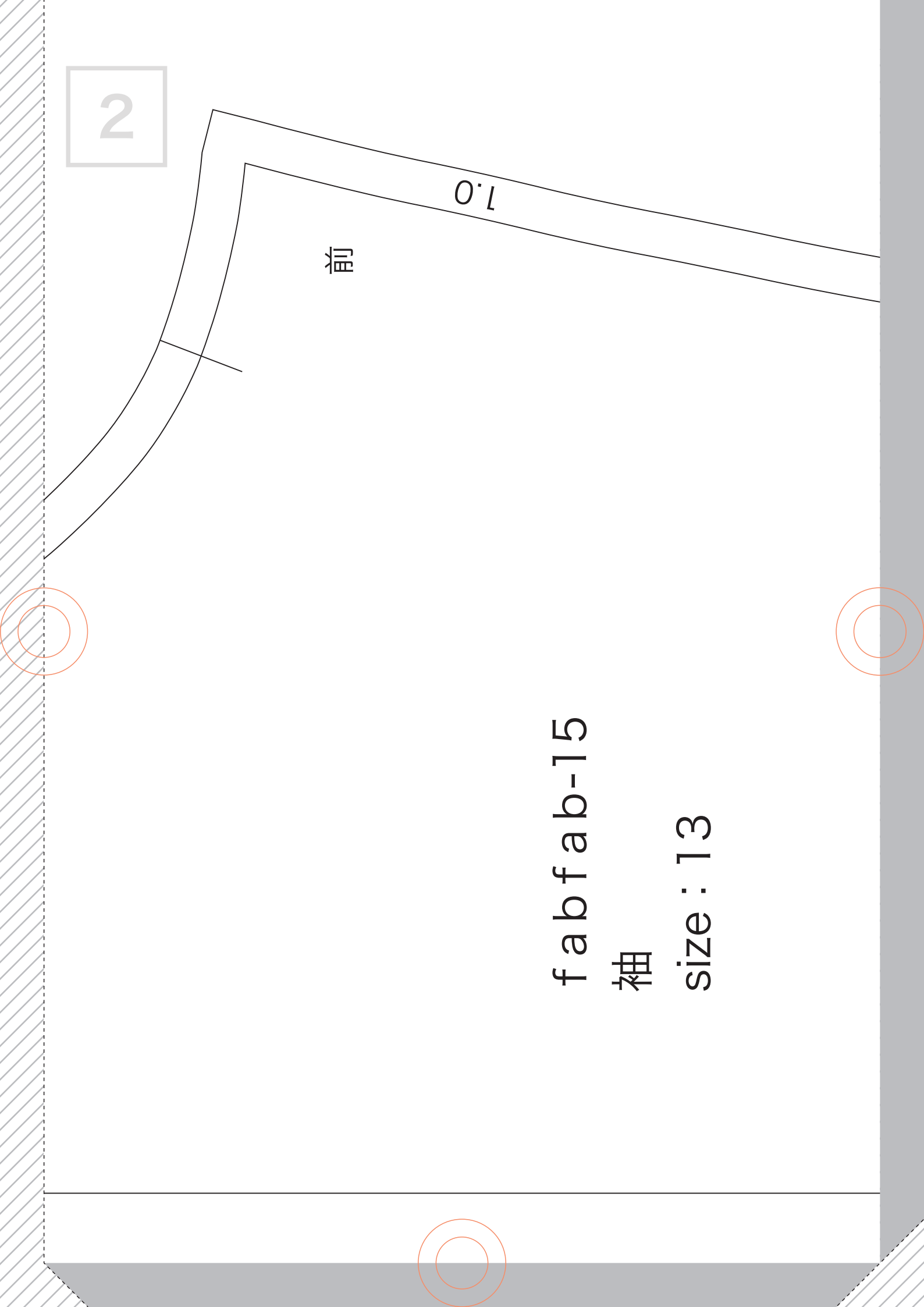

2

前

1.0

f a b f a b - 1 5

袖

s i z e : 1 3

3

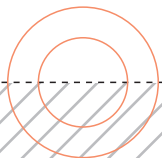
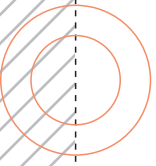
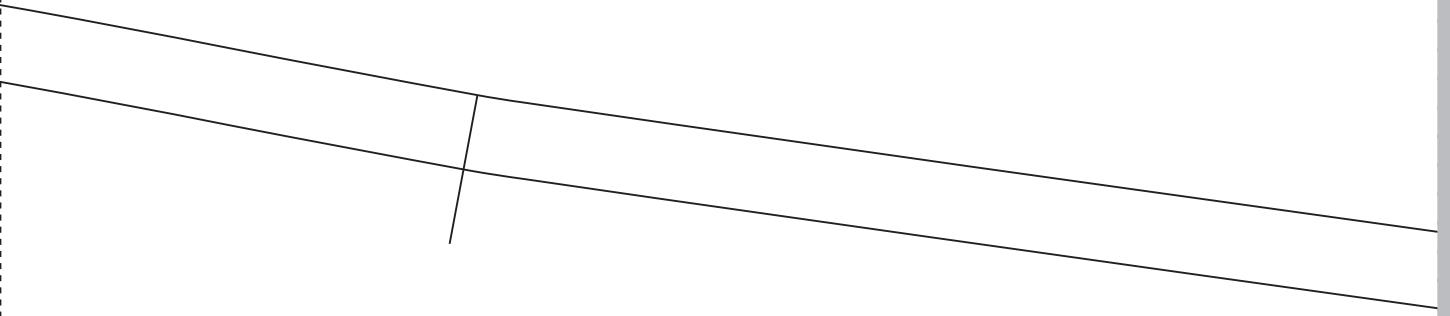

4

1.0

タックの方向

タック

タック

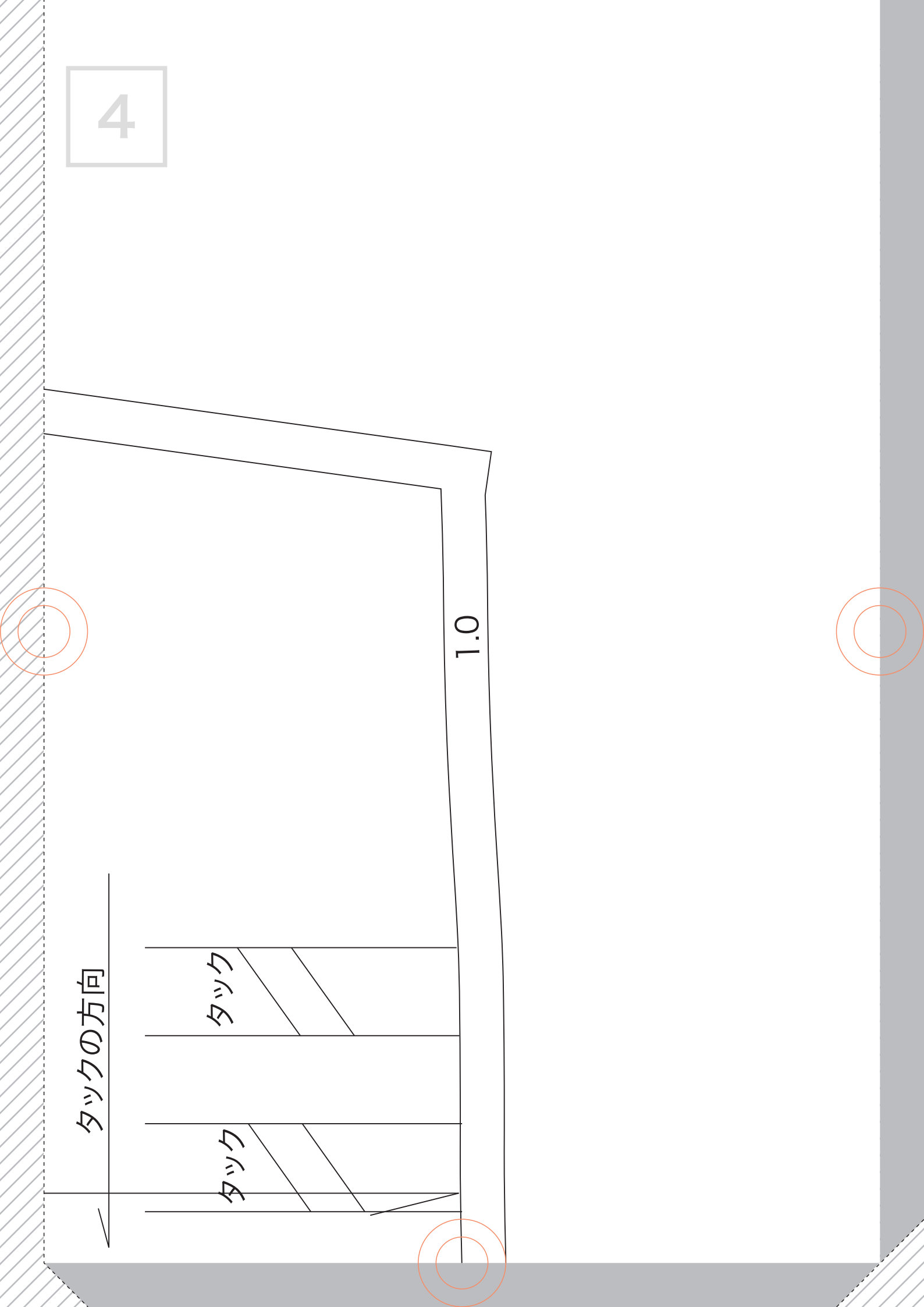

5

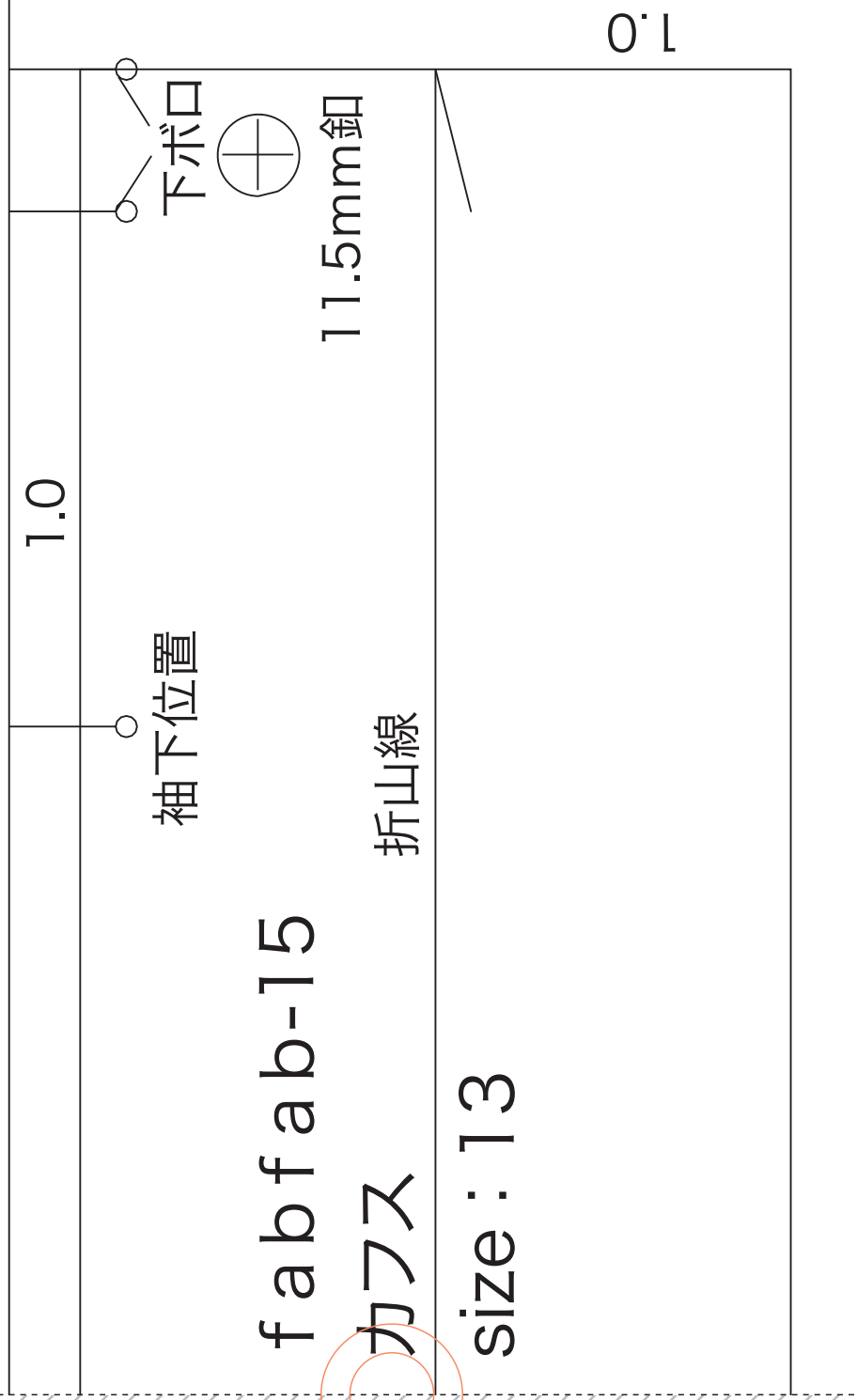

6

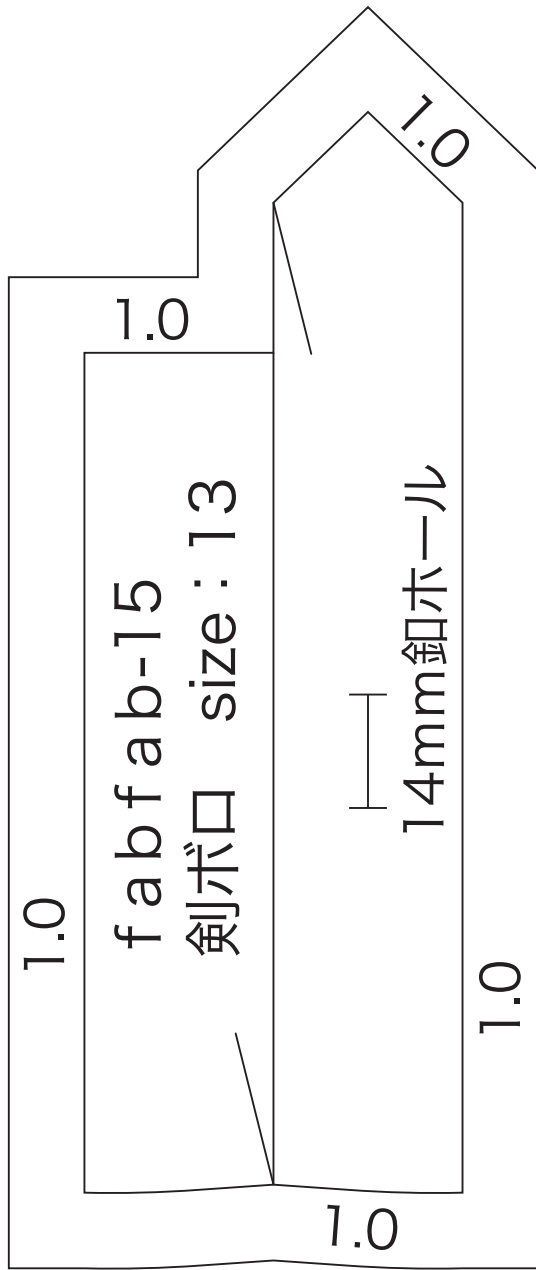

7

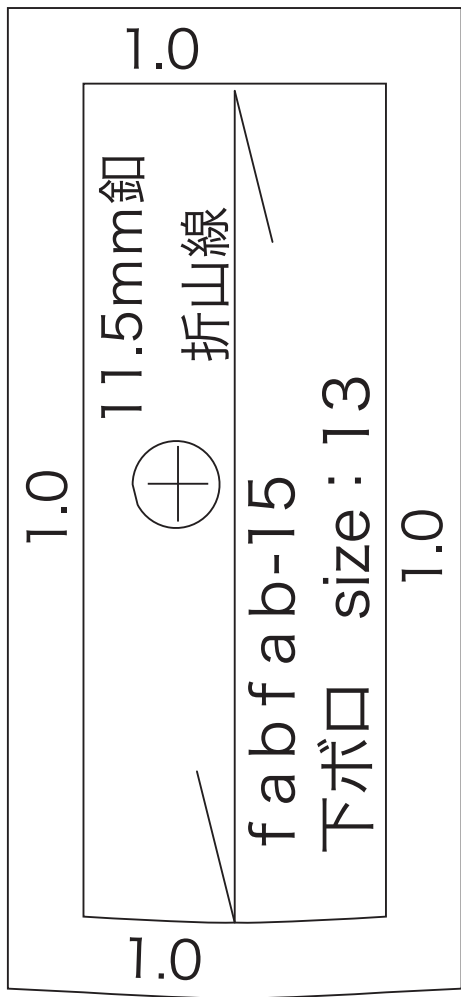



8

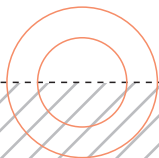
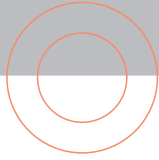

1.0

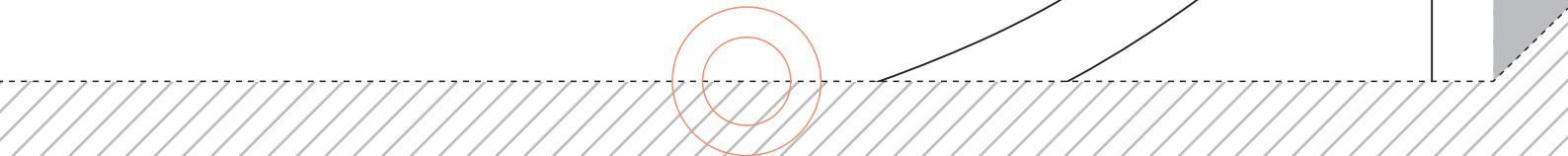

9

後ろ

1.0

1.0

1.0

バルト通しつけ位置

10

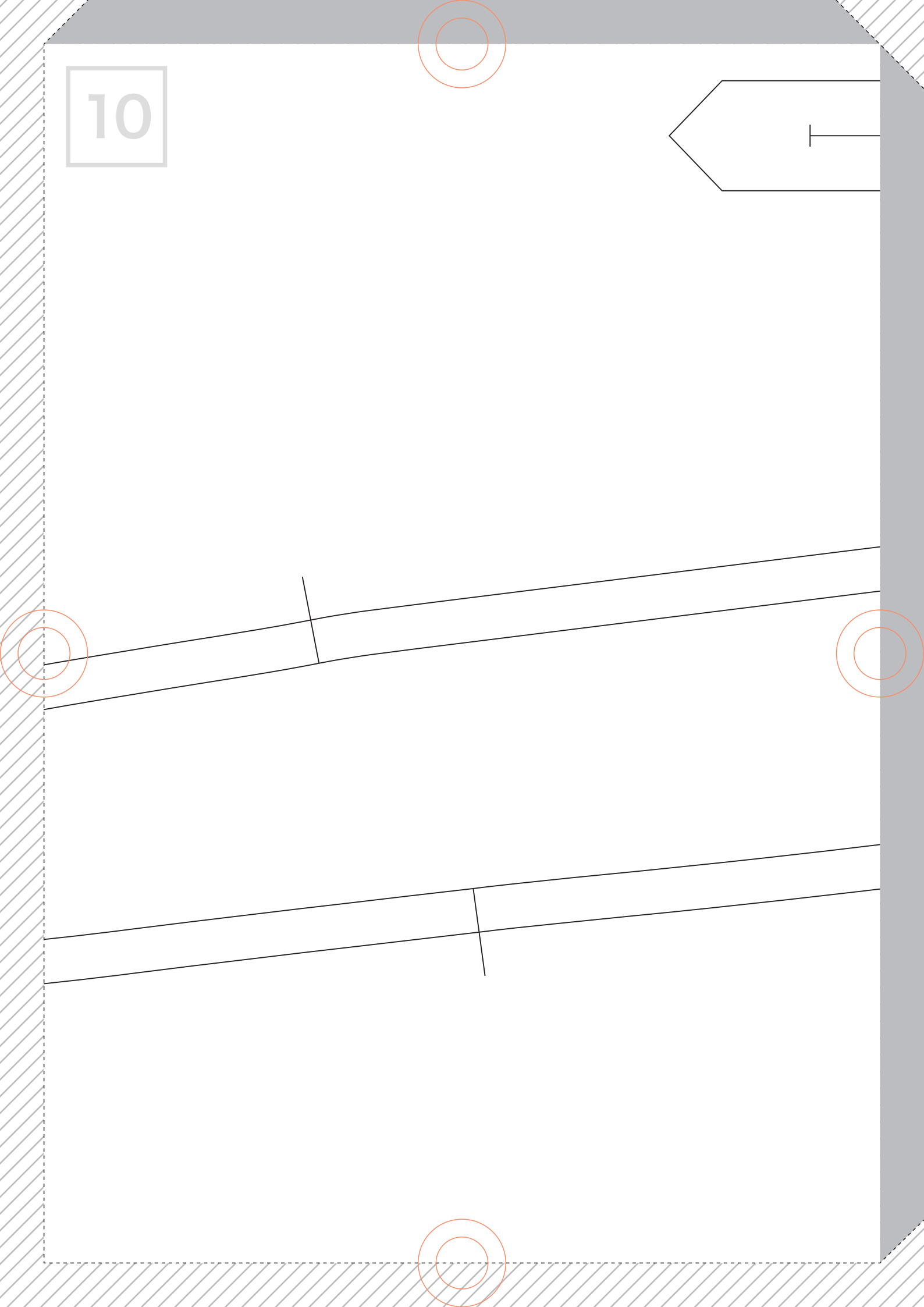
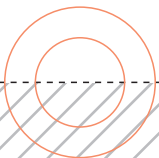
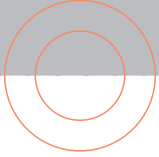
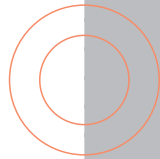
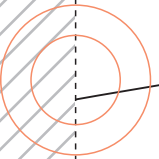
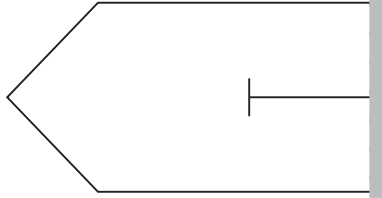

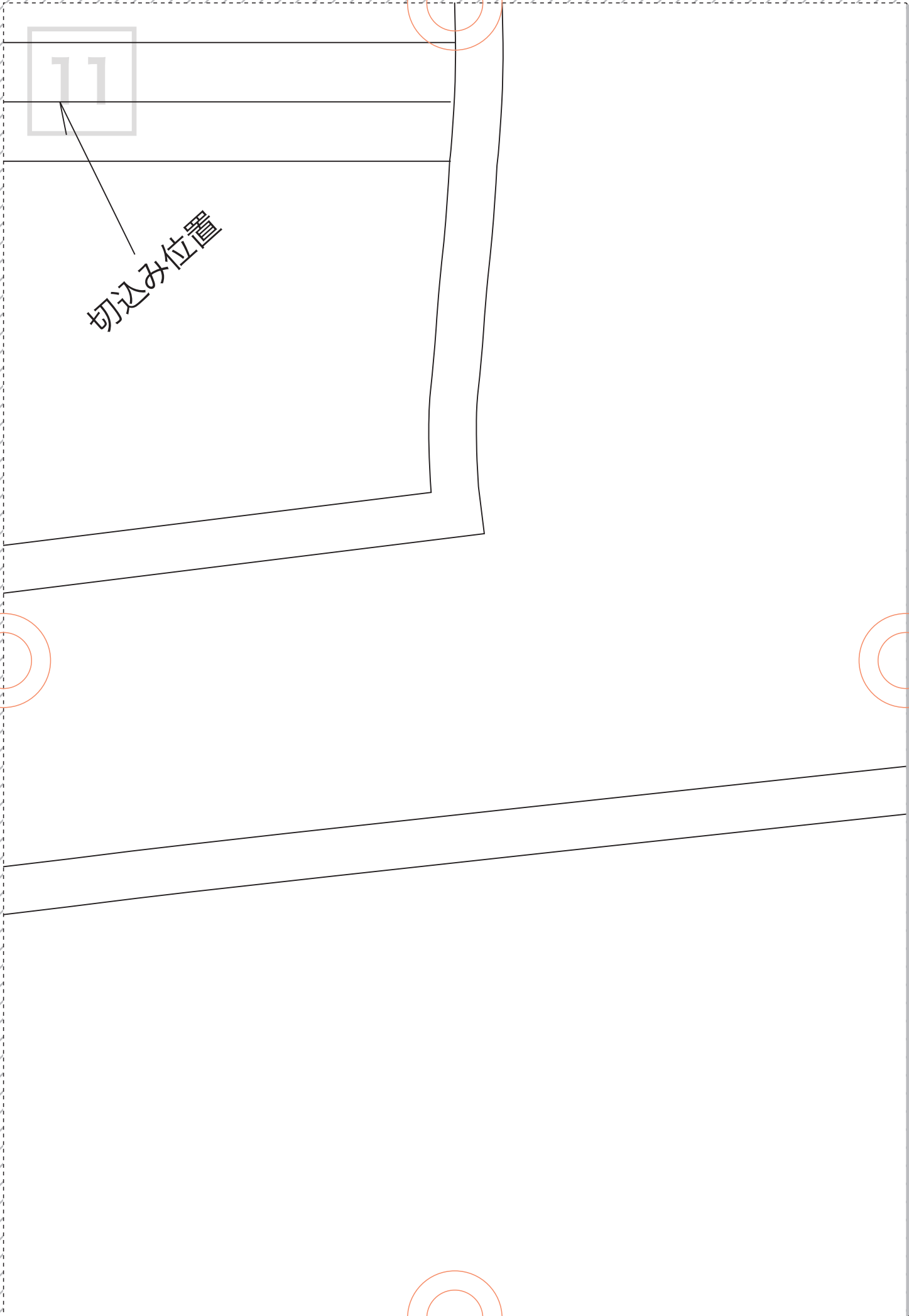

11

切込み位置

12

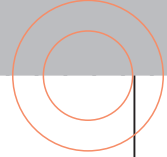
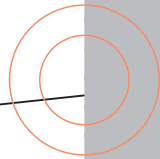
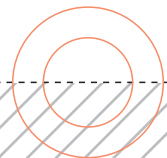
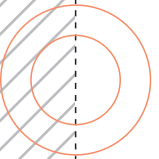
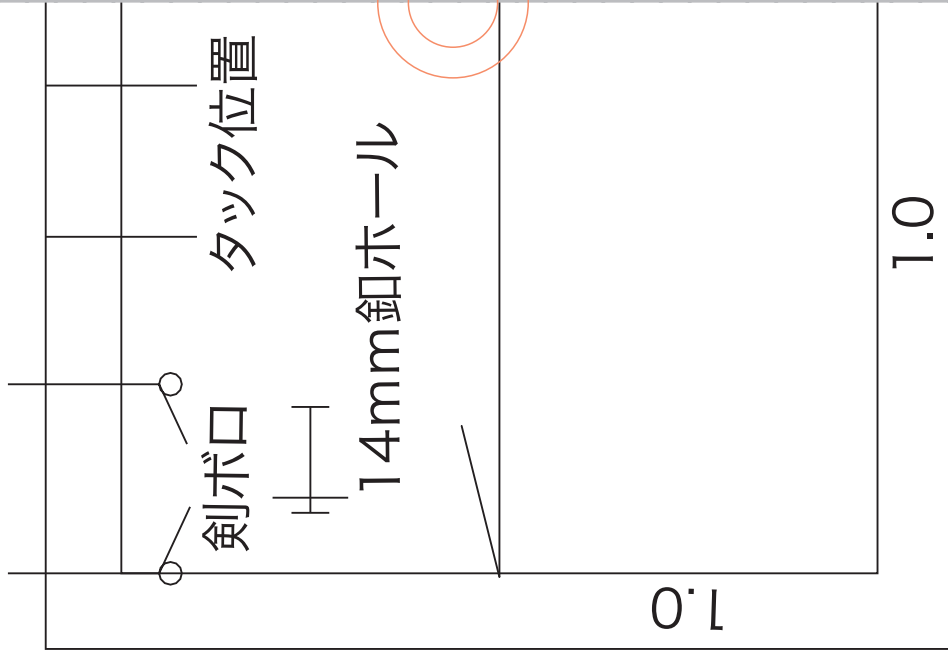

13

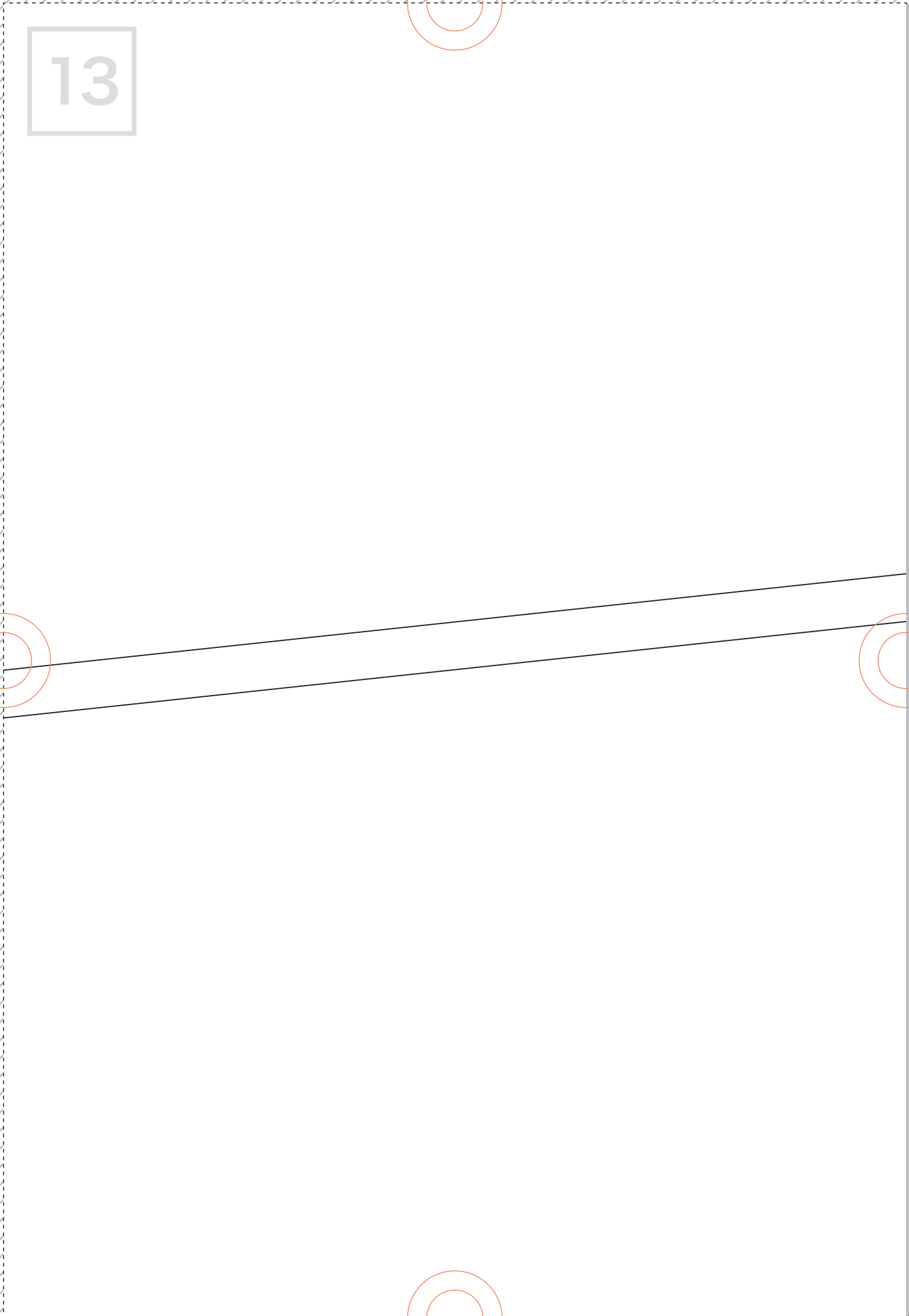
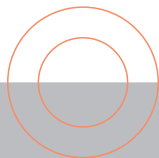
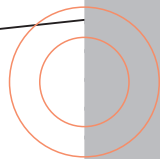
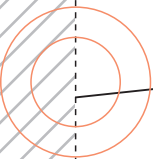
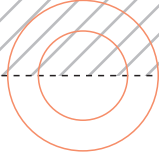

14

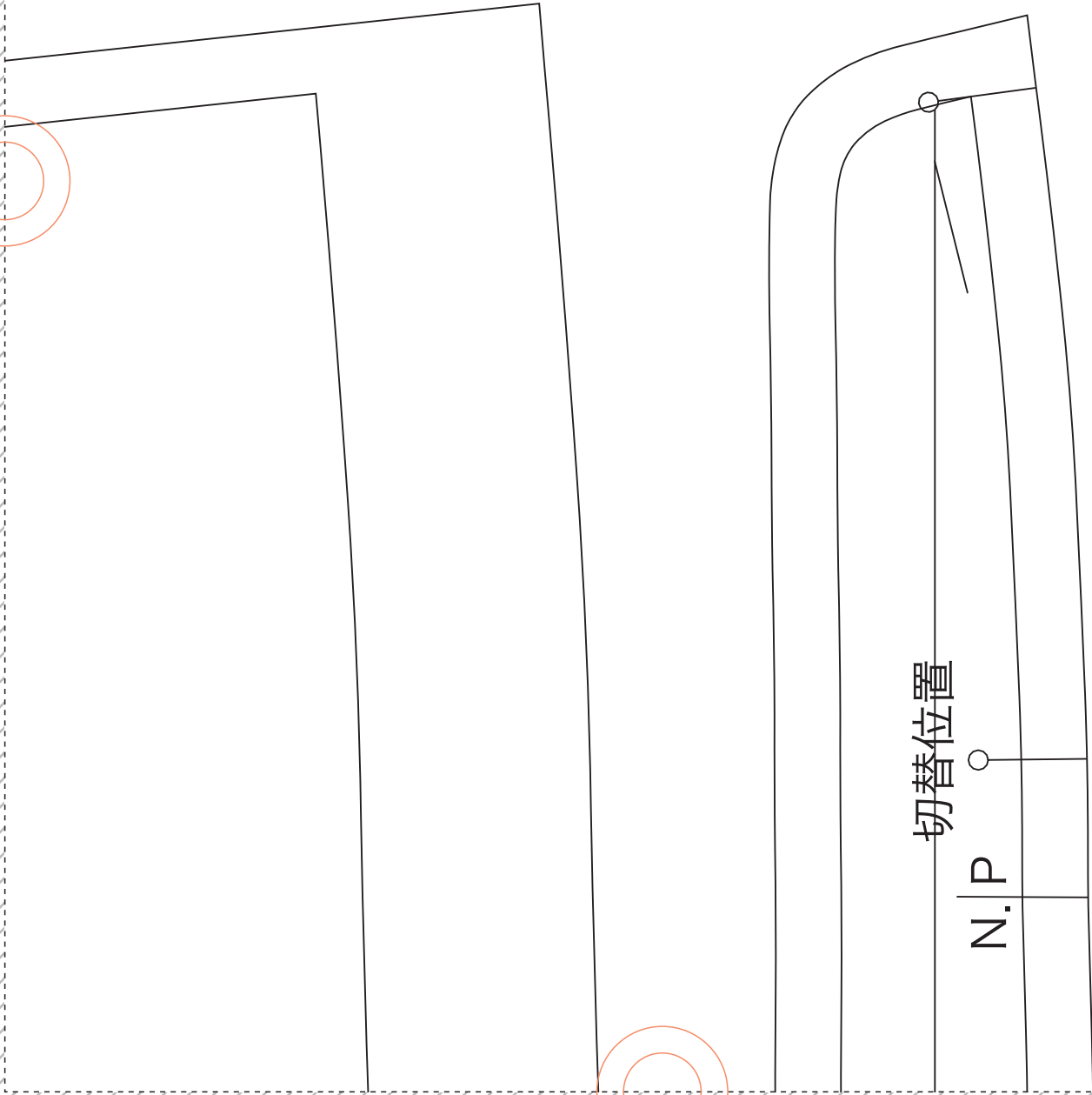
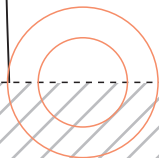
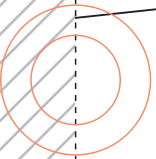
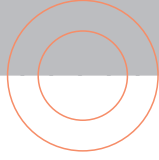

切替位置

N.P

15

1.0

タツク

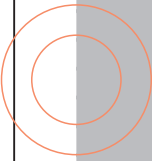
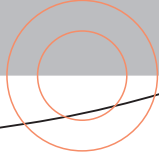



16

fabfab-15

後ろ

size : 13

後ろ中心わ

17

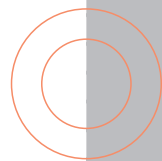
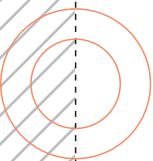
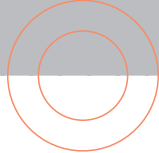

18

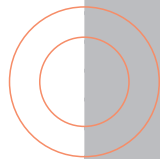
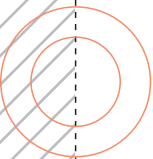
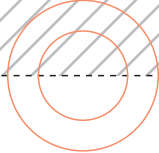

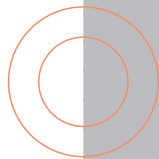
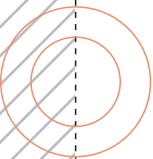
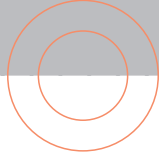

---

---

20

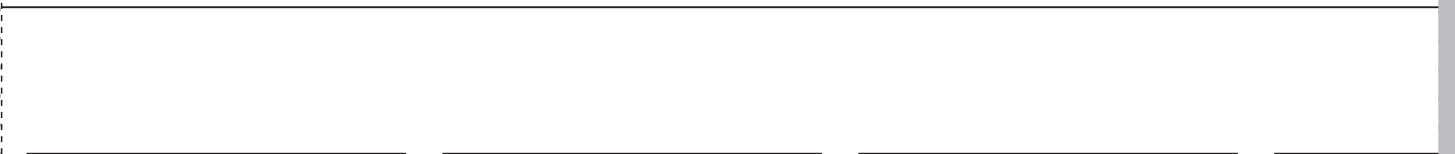
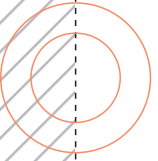
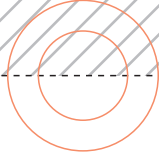

21

3.5

1.0

fabfab-15 size: 13

衿

1.0

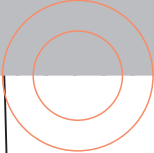
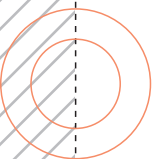

22

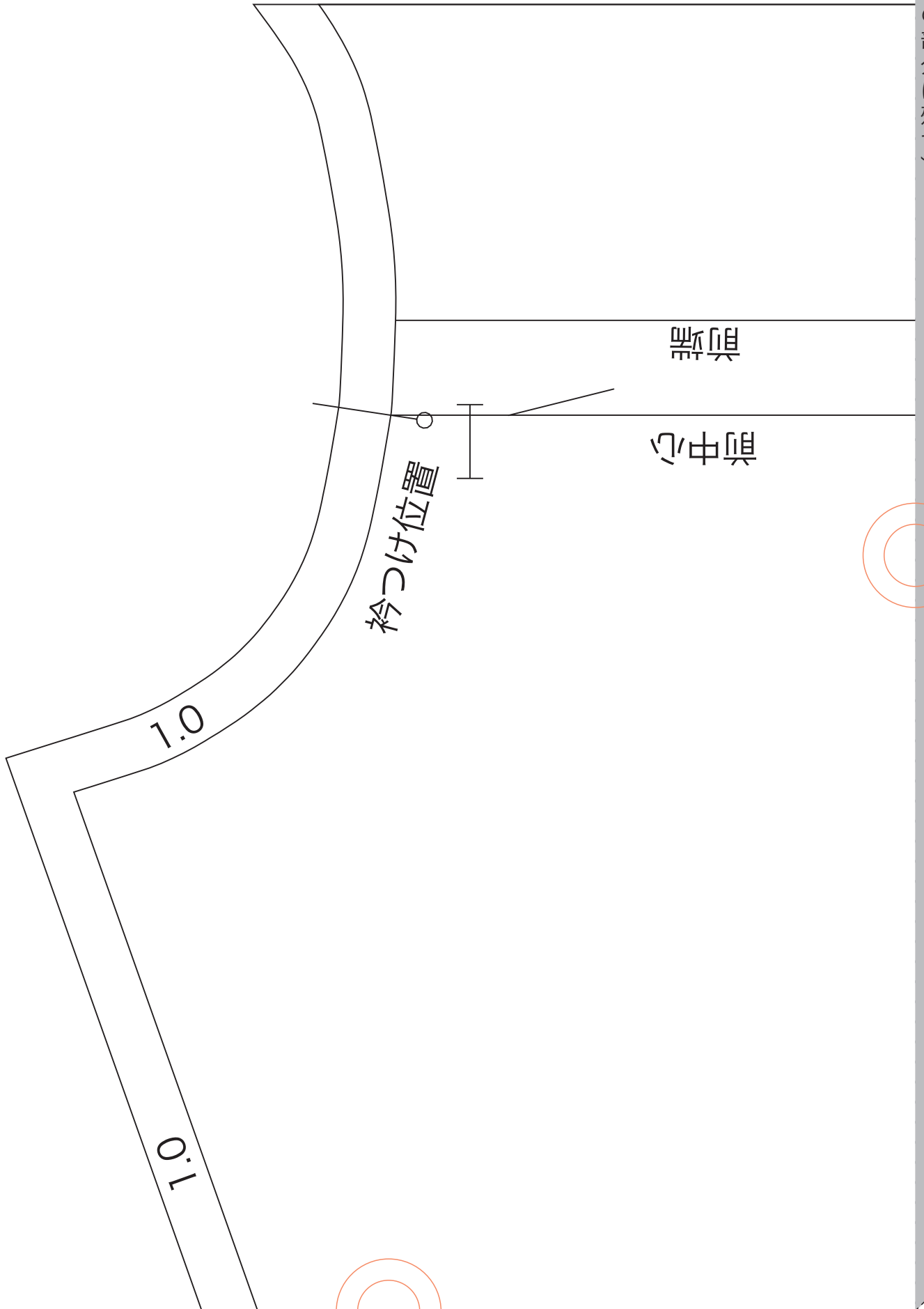

切り取る (斜線部はカット)

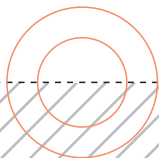

23

見返し

11.5mm釘  
14mm釘木一儿



24

fabfab-15

前

size : 13

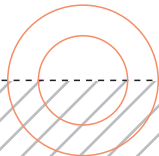
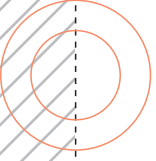

25

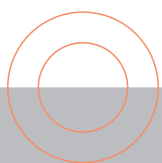
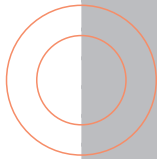
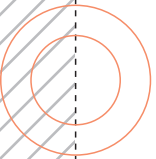
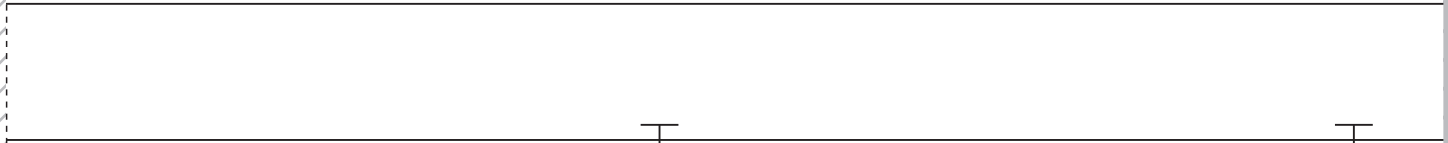

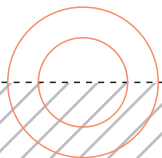
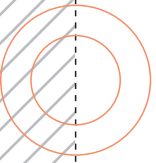

27

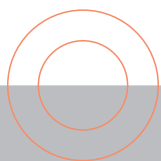
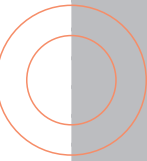
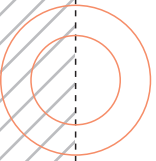

28

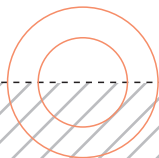
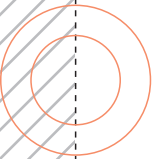

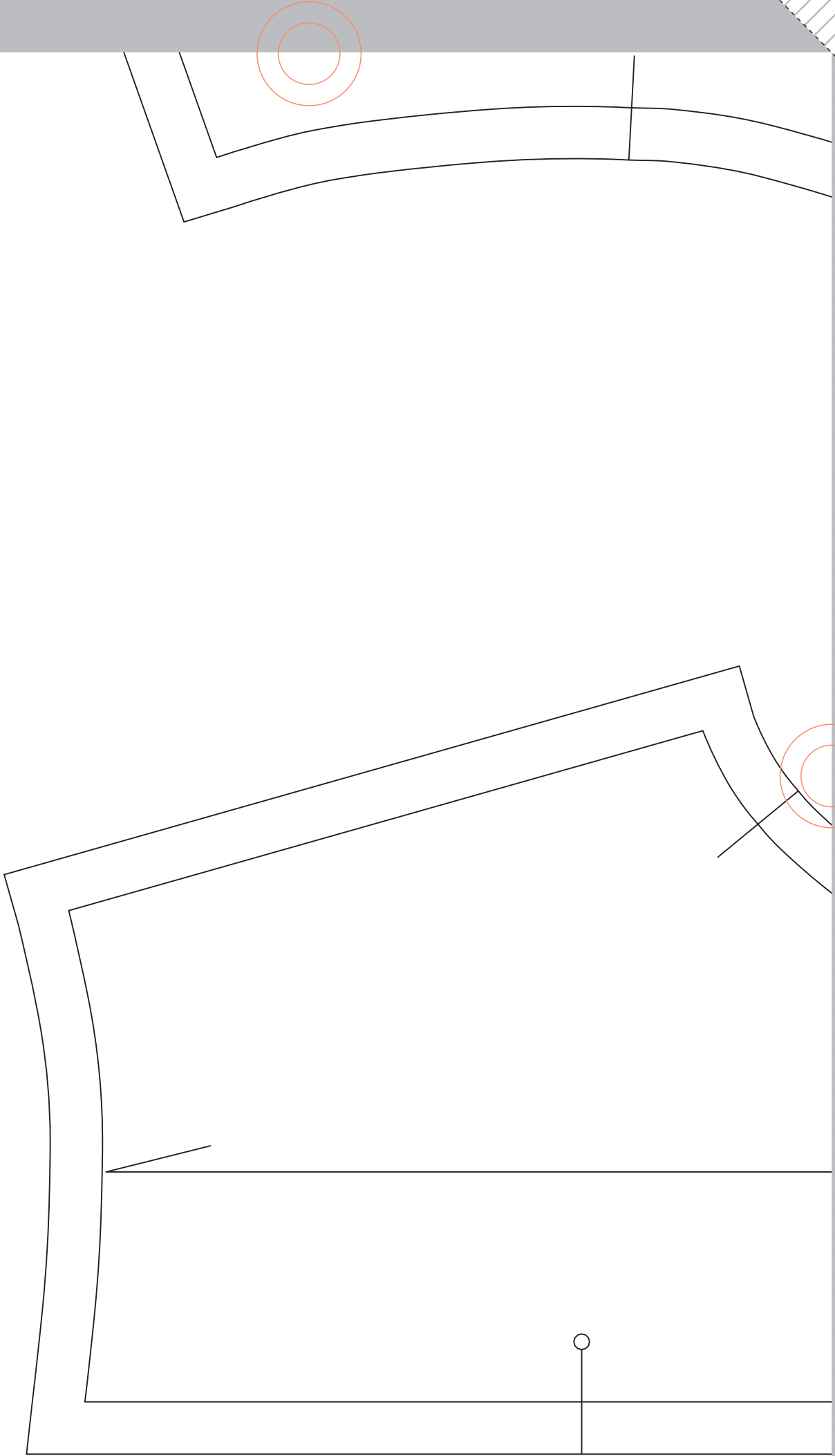

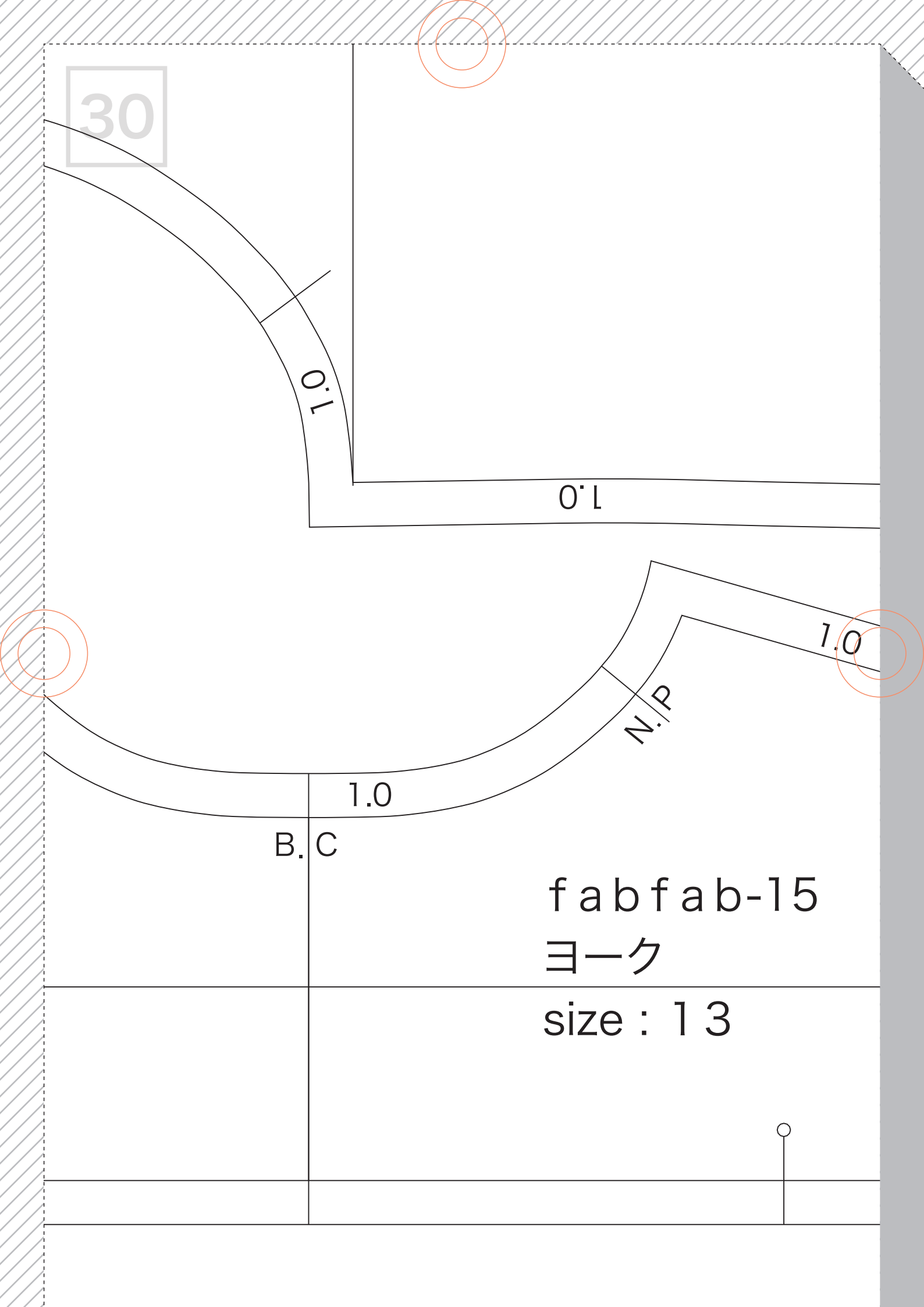

30

1.0

0.1

1.0

1.0

N.P

B. C

fabfab-15

ヨーク

size : 13



31

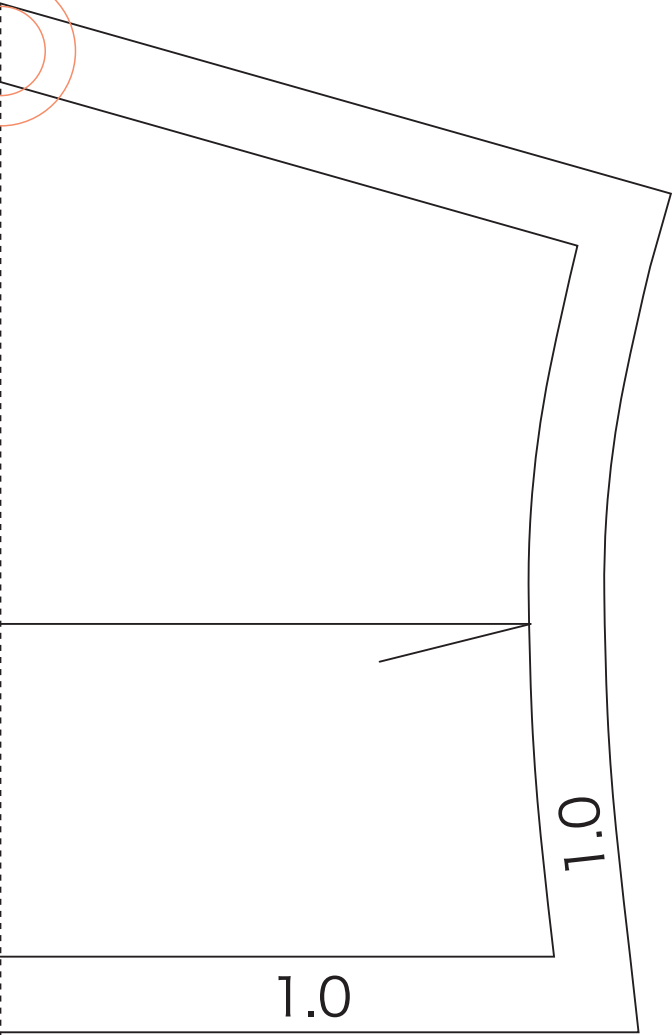
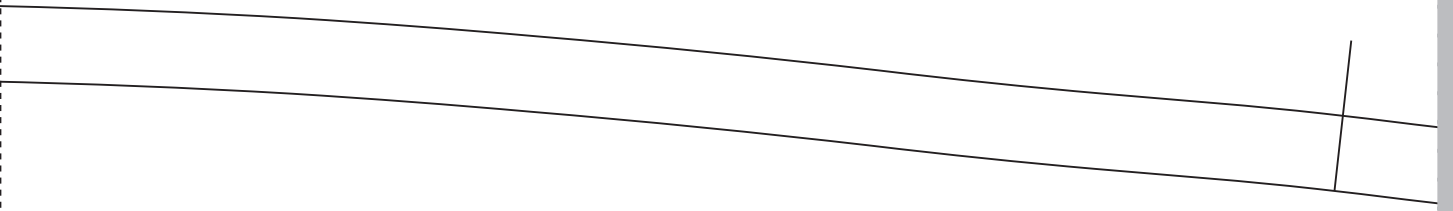
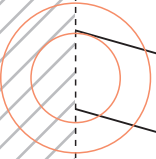
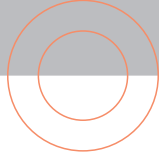



32

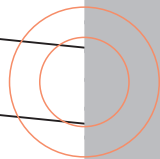
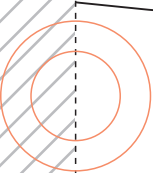
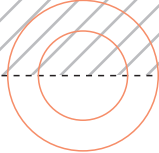

33

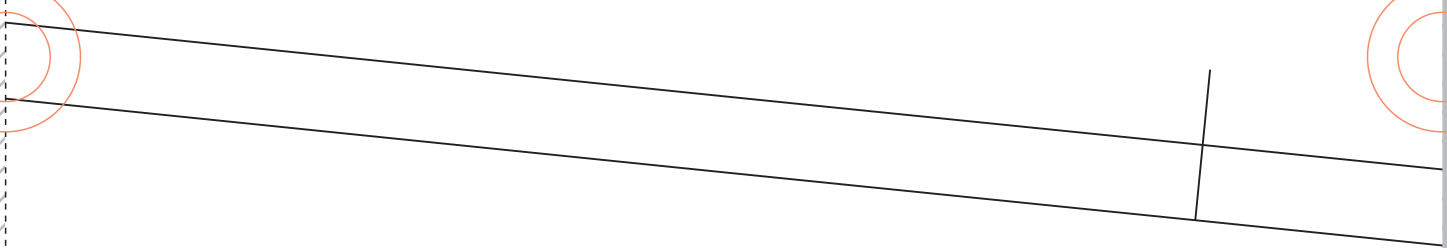
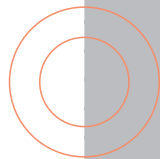
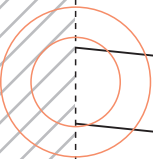

34

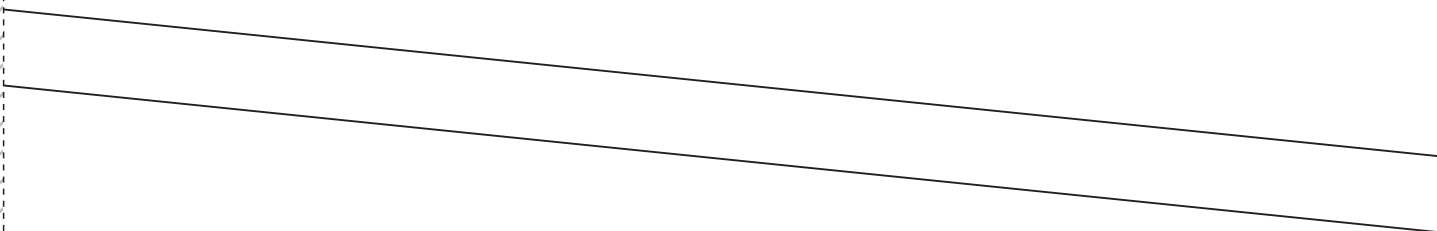
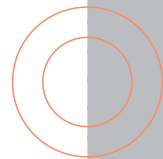
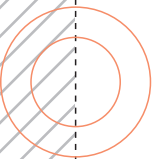
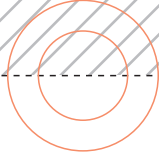

35

3.5

